

Win!
Five A570 CD-ROM
drives must be won!

AMIGA FORMAT

ISSUE 35 ■ JUNE 1992 ■ £3.95

Stunning!
Complete £60 package

The **AMIGA** Collection
FORMAT

No.3 RRP £60 **Spectracolor Jr**
from Oxxi-Aegis



COMPLETE HAM PAINT PROGRAM!

You might have Deluxe paint II or III, but can you paint using all 4,096 of the Amiga's colour at once? With this you can: featuring unique blend setter and 'wrap on shapes', it's amazing!

● A 500 Plus Compatible ● Requires 1Mb ●

Down at the Arcade

Easy AMOS

Start messing with code using this fabulous demo, complete with sample programs!

Croak
Complete game - froggy fun!

Microbe
Complete game - batty bug blasting!

QuickMoney
Complete game - two-player robohunting!

Plus a bunch of other bit 'n' pieces, too!

AMIGA FORMAT

1Mb and 512K ● A 500 Plus Compatible

Make it easy on yourself!

How to get great results in art, design and music the easy way... by cheating!



Graphic Adventures

Prepare to be stunned by top new releases of the hottest graphics programs!

NO COVERDISKS?
THEN ASK FOR THEM FROM YOUR NEWSAGENT

HOTTEST GAMES REVIEWED!
Pacific Islands, Addams Family, Apidya, Eye of the Beholder II
BEGINNERS: Discover how to make a self-booting disk

Future
PUBLISHING
Your guarantee of value



Creepy, Kooky

They've got the creepiest house in town!

But not now that they've been evicted!
Morticia, Lurch, Granny, Pugsley and Wednesday
have gone back to their creepy abode to regain
possession.

They're the Spookiest family around!

But not now that they've disappeared!
As Gomez you must find your loopy loved ones
in their spooky mansion house.

They have the Gookiest friends ever!

But watch out for Tully Alford - he plays mean.
Tully is the treacherous lawyer intent on stealing
the family fortune and who has many a dirty trick
up his sleeve.

They dance a wacky dance!

And you'll be shakin', rattlin' and rollin' when the
spikes, monsters and ghosts save the last one for
you! If you solve the puzzles and follow the clues
you might just save the
Addams Family so that
they can...

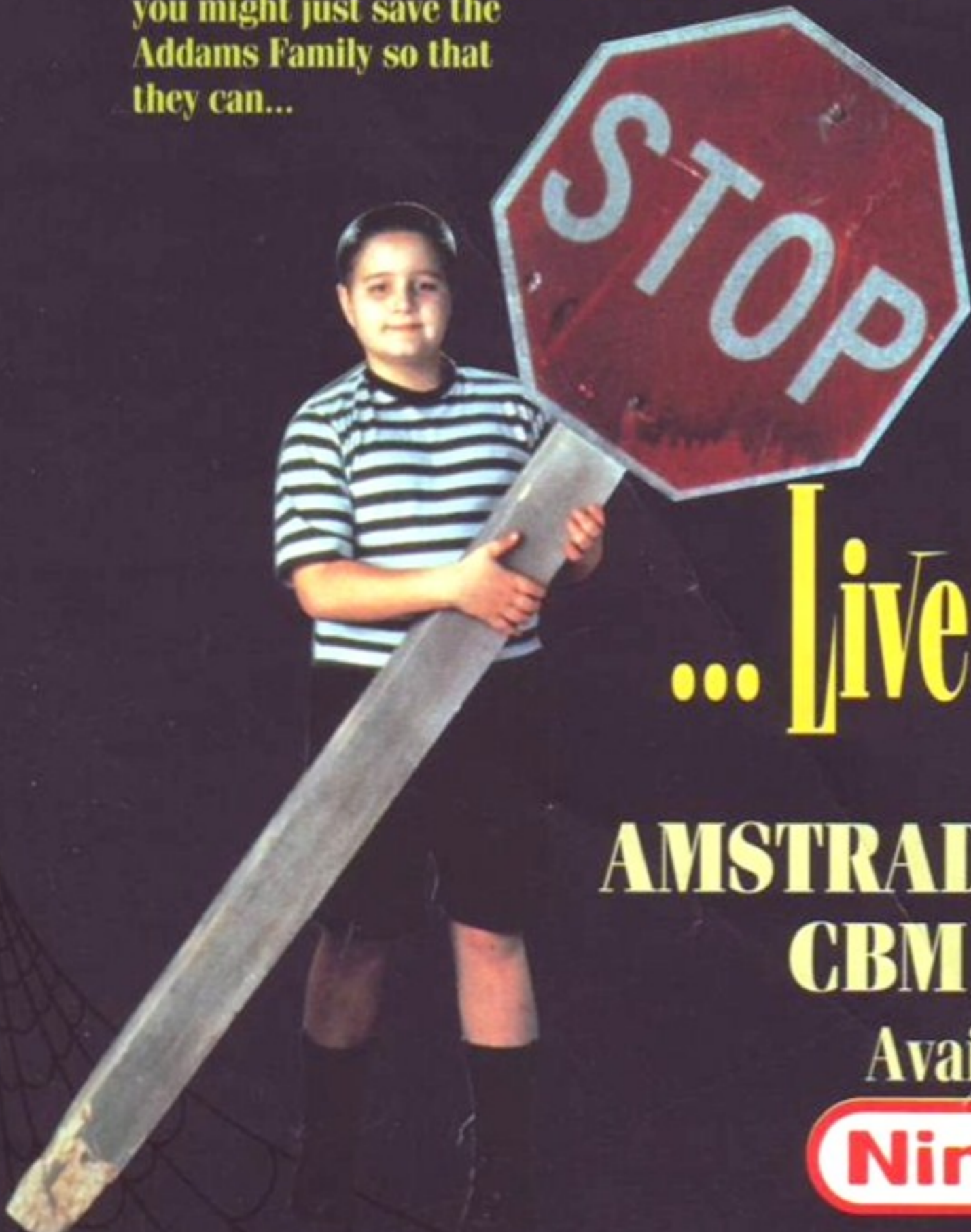

... Live how they wanna live!

AMSTRAD - ATARI ST
CBM AMIGA

Available on

Nintendo



OCEAN SOFTWARE LIMITED · 6 C
TELEPHONE: 061 832

Ooky, Spooky!

The Addams Family



AL STREET · MANCHESTER · M2 5NS
33 · FAX: 061 834 0650

THE ADDAMS FAMILY TM & © 1991 PARAMOUNT PICTURES.
ALL RIGHTS RESERVED. THE ADDAMS FAMILY LOGO IS A TRADEMARK
OF PARAMOUNT PICTURES. OCEAN SOFTWARE LTD. AUTHORIZED USER.

AMIGA FORMAT 35 JUNE 1992

EDITORIAL DEPARTMENT

EDITOR	Damien Noonan
SCREENPLAY EDITOR	Neil Jackson
TECHNICAL EDITOR	Pat McDonald
STAFF WRITER	Maff Evans
PRODUCTION EDITOR	Gary Lord
EDITORIAL ASSISTANT	Clare Hodgson

ART DEPARTMENT

ART EDITOR	Marcus Dyson
DESIGNER	Lam Tang

ADVERTISING DEPARTMENT

ADVERTISING MANAGER	Jonathan Bint
DEPUTY AD MANAGER	Duncan Ferguson
GAMES SALES MGR	Cheryl Beesley
SENIOR SALES EXEC	Tim Partridge

PUBLISHING

ADVERTISING PRODUCTION	Nicola Lucas
PROMOTIONS MANAGER	Michele Harris
PROMOTIONS ASST	Tamara Ward
CIRCULATION MANAGER	Sue Hartley
CIRCULATION ASST	Kate Elston
PUBLISHER	Greg Ingham
GROUP ADMIN ASST	Louise Truelove

PRODUCTION

PRODUCTION TECHNICIANS	
Simon Windsor, Chris Stocker,	
Jerome Clough, Simon Chittenden	
PHOTOGRAPHY	
Ashton James (Bradford-on-Avon)	
ILLUSTRATION	
Mike Roberts, Devizes	
COLOUR REPROGRAPHICS	
Bath Graphics	
Phoenix Reprographics (Bath)	
PRINTED BY	
Chase Web Ltd, St Ives PLC, Plymouth	
NEWSTRADE DISTRIBUTION, UK	
Future Publishing, 0225 442244	
NEWSTRADE DISTRIBUTION, OVERSEAS	
MMC Ltd 0483 211222	

AMIGA FORMAT

30 Monmouth Street
Bath, AVON, BA1 2BW
Telephone 0225 442244
Facsimile 0225 446019

SUBSCRIPTIONS, BACK ISSUES

MAIL ORDER DEPARTMENT

Future Publishing, Somerton,
SOMERSET, TA11 6TB
Telephone 0458 74011
Facsimile 0225 446019



No part of this publication may be transmitted or reproduced in any form without the permission of the publishers. So don't do it.

Observation of the month:
If only 1,245 people had voted the other way in 11 key seats, the Tories would not have got in.

Member of the Audit Bureau of Circulations.



Registered Circulation

130,143

July - Dec 1991

News

19

So, what do the movers and shakers in the computer industry think of the new A600 and its 'smart card' slot? Will it make any real difference to them, and to you? Find out here!

Screenplay

41

The complete low-down on all the latest games

Coming Attractions 42-43

Find out what's in store for the future, and take a close-up look at Mike Singleton's new Ashes of Empire

Under Construction 47

Schizophrenic views of Palace's forthcoming computer-movie Jekyll and Hyde

The Next Big Thing? 48

Could football-crazy Striker be all the Rage next month?

Reviewed this month...

Agony	87
Alcatraz	86
Apidya	83
Castles	75
Deliverance	69
Eye of the Beholder II - The Legend of Darkmoon	54
HeroQuest - The Return of the Witchlord	86
Leisure Suit Larry 1 Remake	53
Might & Magic III - The Isles of Terra	80
Ork	86

Reviews

Coming Contraptions 117

Find out what's new in 'serious' software and hardware

SuperJAM! 122

What do you do if you have no musical talent? Use this!

X-OR 127

The only way to make weird new sounds for your synth?

V-LAB digitiser 130

Real-time Video grabbing reaches a new all-time high...

Expert Draw 134

Could this open up a new area of Amiga use for you?

Imagine 2 138

The very best 3D graphics program just got better!

TV Paint 142

New improved 24-bit painting with the best in the biz

Vista Professional 2 150

The fractal landscape reaches stunning new heights

Regulars

PD Update 159

The best way to find out what's cheap and excellent

Workbench 196

Your problems solved, your questions answered

Letters 211

Find out what's making waves with Amiga owners

Mail Order 182

We pick out the best and offer it at bargain prices

Subscriptions 156

Make it easy on yourself: get your mag delivered

Cheap 'n' Cheerful 94-95

Not all budget games are last year's hits at low prices. We've got two that are brand new and cheapy too

Charts and Magical History Scores 97-98

Out of the blue, a brand new game shoots straight to Number One. Betcha can guess what it is

Gamebusters 101-107

To get along with Cadaver, you'll need these helpful hints.

Pacific Islands.....	50
Pools of Darkness	62
Project X.....	76
Samurai - The Way of the Warrior	86
Space Quest IV	61
Special Forces.....	57
Superski 2.....	88
The Addams Family	66
The Manager.....	87
Vengeance of Excalibur.....	87
World Class Rugby - 5 Nations Edition.....	70



REVIEWED:
ViatPro 2

The familiar fractal landscape modeller can do the most astonishing things in its new Professional incarnation: just look at those images!

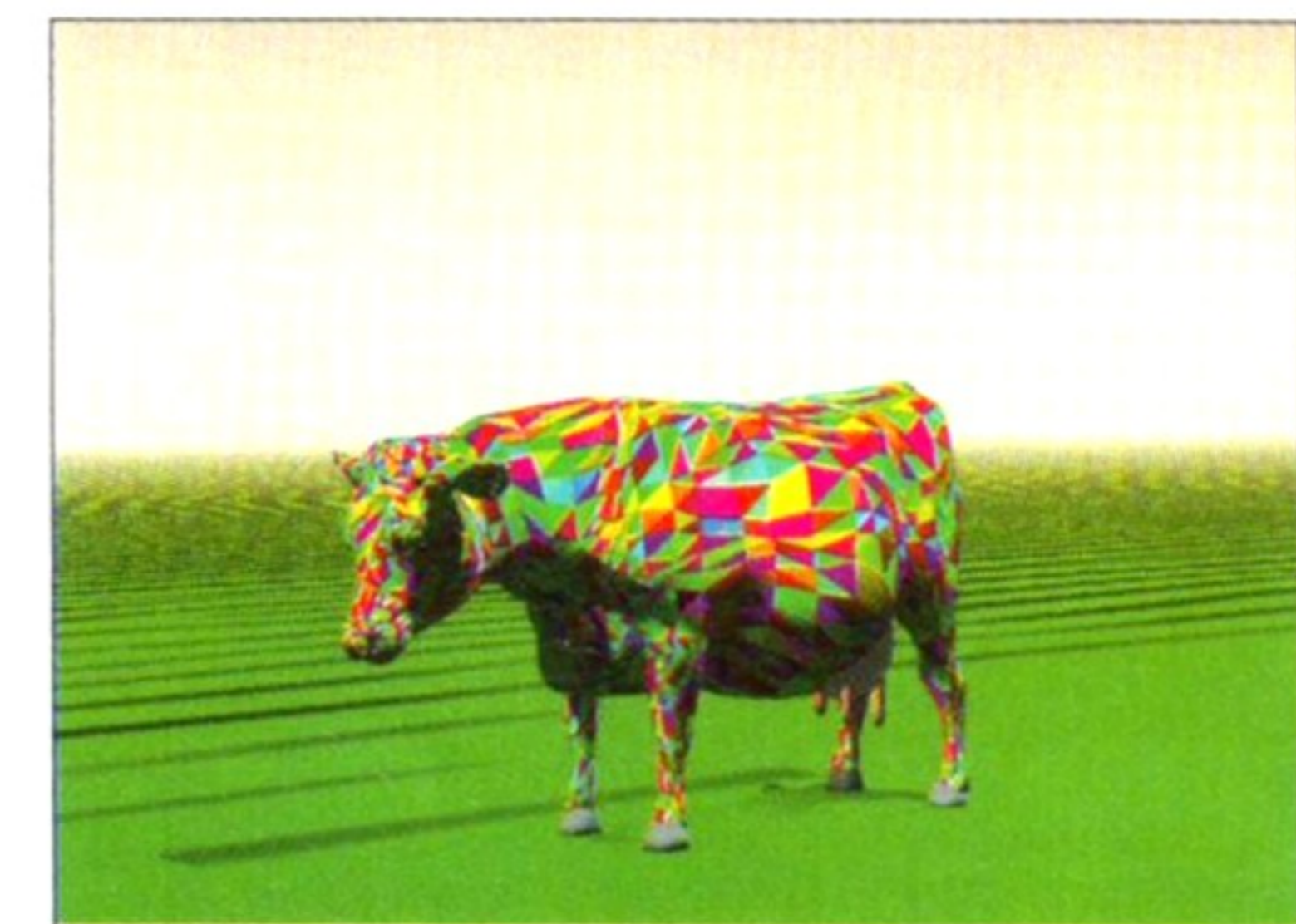

REVIEWED:
Imagine 2

The best in the business at the art of 3D modelling with ray-traced surfaces, and it just got better. Have a look at what it can do!



REVIEWED:
TV Paint v1.6

The high art of 24-bit painting is at its peak with this package: even if you don't want to buy it, do some window-shopping!



IN PUBLIC DOMAIN

The wonderful world of the PD demo is explored once more by Maff Evans, the man who knows a groovy hip-house dance demo from a margarine tub.



When you put the joystick down and start getting creative, the Amiga is the most versatile tool for art, music, design and more.

But what do you do if you discover you don't quite have the talent to produce something stunning?

Like thousands before you, you cheat, that's what! We'll show you the short-cuts and where to get ready-made materials that can turn you into an Amiga expert...

Make it easy on yourself 26

Win one of five A570 CD-ROM drives! 178

Starting this month, the regular Grand Amiga Format Quiz kicks off by joining with Calculus to bring you the chance to win a £300 CD-ROM drive!



Win a wild weekend out! 88

Fancy joining the Special Forces? Now's your chance to win a weekend of outdoor pursuits, jumping off waterfalls and eating beetles, in this special MicroProse competition...



Getting to grips with Workbench 189

In the next exciting episode of the essential series for Amiga novices, it's time for you to make your first self-booting disk and create a slideshow of your pictures. Yes, you can do it!



Welcome to Amiga Format!



Damien Noonan, Editor

Hello and welcome to **AMIGA FORMAT**, the world's best-selling magazine especially for Amiga owners!

You are now reading the biggest-selling computer magazine

in the whole of Britain. Part of the reason for this is that the Amiga is far and away the most popular home computer there is: and home computers are owned by dedicated, enthusiastic people who really care about getting the best from their machines.

But we also like to think that it's because we genuinely care about bringing you the best possible magazine. This magazine is created by an enthusiastic team of experts who are constantly striving to make this the magazine that you most want to read. To our way of thinking, this is a simple formula: it's all about news, reviews, advice and exploration.

We get the exciting news first: that's why we bring you the latest opinions on the new Amiga A600 this month.

Our reviews have consistently been voted by computer retailers as the ones that help them most when they're deciding what to stock: so we are clearly to be trusted when it comes to advice on what to buy. You can normally rely on us to bring you the first reviews of new software and hardware: and you can certainly trust our integrity when it comes to deciding what to buy.

Then there's the tips and advice sections: Gamebusters for cheats and clues on beating the best games, and Workbench to answer all your questions on the more technical side of things.

Add in the features that help you explore new areas and get complete control over your Amiga, like 'Make it Easy on Yourself' this month, and you have a package that can't be beaten for quality. Read on!

COVERDISK turn the page!

AMIGA FORMAT

Down at the Arcade



Easy AMOS

Start messing with code using this fabulous demo, complete with sample programs!



1 Mb and 512K • A 500 Plus Compatible

Croak
Complete game - froggy fun!

Microbe
Complete game - batty bug blasting!

QuickMoney
Complete game - two-player robohunting!

Plus a bunch of other bit 'n' pieces, too!

Easy Amos



If you've ever wanted to try your hand at programming, now is your chance! You can use this demo to explore the challenge of what is said to be the easiest way ever to learn to program: and it's fun, too!



Croak! Froggy fun in this complete game. Cross the road, don't get squished!

Microbe A startlingly original little shoot-em-up of a weird and highly enjoyable kind...

Quick Money Two-player action gets frantic in the robo-hunting arena...

PLUS Hunter III Make it a little bit easier on yourself with this sample-ripping utility

on page 11...

The **AMIGA** Collection

Spectracolor Jr

from Oxxi-Aegis

No.3 RRP £60



COMPLETE HAM PAINT PROGRAM!
You might have Deluxe paint II or III, but can you paint using all 4,096 of the Amiga's colour at once? With this you can: featuring unique blend setter and 'wrap on shapes', it's amazing!

● A 500 Plus Compatible ● Requires 1Mb ●

SpectraColor Jr

The third in The Amiga Format Collection series of COMPLETE, FULL-PRICE PACKAGES, this is your easy way in to HAM painting.

If you've only ever explored graphics with Deluxe Paint 2 or 3, now's your chance to try painting in 4096 colours. You'll soon see what a difference it can make, and it's fun too!

Down at the Arcade

Easy AMOS

Start messing with code using this fabulous demo, complete with sample programs!

Croak
Complete game - froggy fun!

Microbe
Complete game - batty bug blasting!

QuickMoney
Complete game - two-player robohunting!

Plus a bunch of other bit 'n' pieces, too!

AMIGA FORMAT

1Mb and 512K & A 500 Plus Compatible

GETTING STARTED

The way the Coverdisk works is very easy. All you do is switch on your Amiga and pop the disk in the disk drive. After a few seconds, a version of Workbench will load - it's much faster than the official version.

Move the pointer (using the mouse) to the small icon of a disk marked 'Coverdisk35b'. Double click with the left mouse button and a large window will open, displaying the contents of the Coverdisk. Just move the pointer again and double click on the icon that you want to run, again with the left mouse button.

Only the *Easy AMOS* demo, *Quick Money* and all the Readme files will let you quit once you have selected them. Incidentally, if you have a printer connected, then you can't print files straight out from the Coverdisk. Instead, load Workbench first, then put the Coverdisk in, double click on the Readme file, and select print. It should work then.

512K users only, I regret that the *Microbes* game on the disk will not load on your machines. This is because the program had to be crunched to fit on the disk. Also, the *Easy AMOS* demo program *Bob_Editor* won't load, and the *Zooming* and *Sound_Generator* demos won't run. All down to lack of memory I'm afraid - but there's other stuff to keep you busy.



We've made the Coverdisk as easy as possible to use. Switch on, boot up, double click and double click again on your selection. Easy as a Big Mac.

Coverdisk

Before you insert your brand-spanking new disk in to your Amiga, let **Pat McDonald** shed some light on the wondrous contents of that magnificent magnetic media.

MICROBES VISION SOFTWARE/PAL Only



The basic theory of *Microbes* is straightforward - just keep whizzing around the outer edge, blasting the larger blobs.

All the way from New Zealand, this excellent little shareware game sounds good, plays fast and is hugely addictive. Prising our new art assistant, Lam Tang, away from it was a real chore, I can tell you! The first thing it does once loaded is display a shareware message. Wait until while this happens, have a read (it's only one screen) and press the fire-button to leave it. Keep pressing fire to get to the game proper.

The plot is quite irrelevant, so I'll skim through it. You and a battle tank have been miniturised in a laboratory, in order to wipe out a germ warfare experiment that's gone out of control. You view the screen through a microscope, and your tank can only move around the edge of the screen.

To play *Microbes* you will need a joystick plugged into your machine. Move left and right to move your tank, and press fire to release some shots in the direction you're pointing. It takes practice to aim at a target, because it's got to be between your tank and the centre of the screen.

There are three main groups of nasties. The Microbes themselves are fairly large blobs (the game starts with green ones, although different varieties crop up later). If you look at

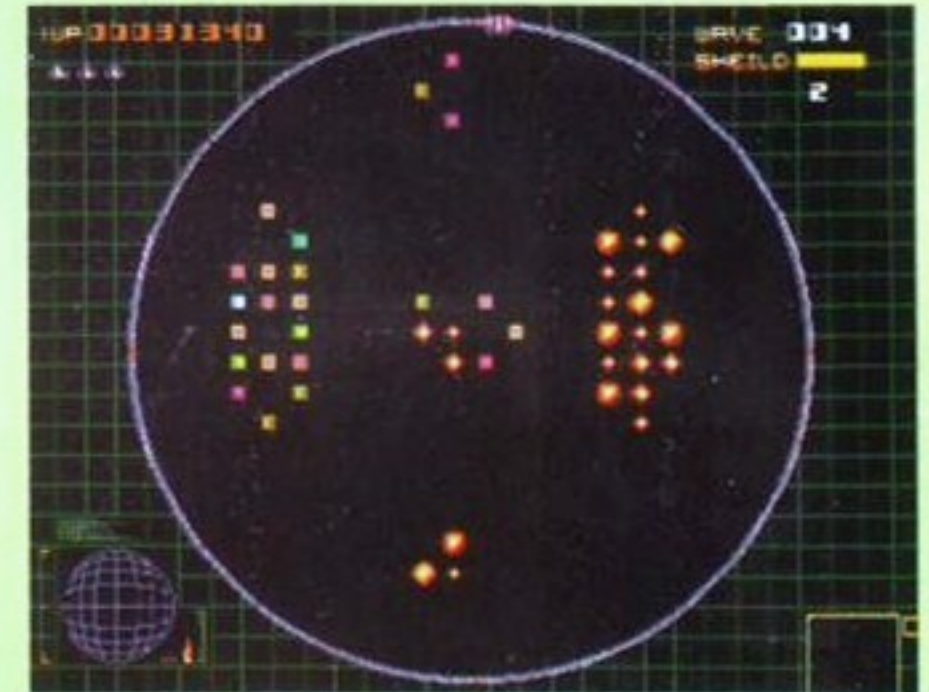

Later on in the game you'll get to some jewel like bugs - but they respond just the same way to your cannon, that is they blow up. Keep blasting!

them closely, you'll see that they pulsate slightly. This pulsing gets faster and faster, until the Microbe becomes a mutant, which starts moving towards the edge of the screen. Don't let it get there, because if it does it will take some energy from your shield - when you're shield gets to zero then you lose a life.

Avoid twitching the joystick up and down, because that's how you activate the smart bomb feature. Pushing up will nuke all the small neuter Microbes on the screen, the clutter left over from shooting the big ones - handy when your targets are obscured by the little ones. Pulling down will destroy all the mutants on the screen.

To finish each screen, you must blast all the large Microbes and mutants. This is easier said than done, because the big blobs reproduce very quickly, producing ever-growing clusters of targets that eventually become mutants that menace your existence. Cor, don't mad scientists make life difficult!

Sometimes, a mutant that's been shot will leave a capital 'F' or 'S'. Shooting the Fs increase firepower, giving faster shots and longer bursts. The Ss are smart-bomb tokens, to use on the later levels.

THE FUTURE OF SHAREWARE - YOU DECIDE

A lot of the programs on the Coverdisk are in fact shareware, and a lot of readers are still rather confused over what exactly that means. In essence, it's just a way of selling software - the difference is that you can try it out for a reasonable time before paying for it. Feel free to pass on copies of the games Coverdisk (NOT *SpectraColor Jr* though) to your friends, so then they can decide whether or not to pay.

The idea is that you try the program out for a few days (the maximum length of time is specified in each Readme document, although a week should be enough in most cases). If you like it and plan to use that program a lot, then you should send off your cash to the author - again, where you send it is specified in the Readme documents, although in the Case of *Microbes* it's the first thing that the program prints.

Now, if you like and use a shareware program and don't bother sending off

any money, nobody is going to chase you about it or tell you off. But remember that effectively you are stealing from programmers - and they are not known for being dumb.

If a programmer releases a really good shareware game or utility, and gets little or nothing for it, then the chances are that they won't bother doing it again. Which means that shareware dies, and you always end up paying for commercial software. Do you really want that?

Programmers are the same as other people, they need to earn a living. Programming is a subtle and intricate activity, and the most rewarding when you get things right. If you have no knowledge of how computer programs work, check out the *Easy AMOS* demo on this month's disk. Then decide for yourself if you want to try it for real or not - and whether the shareware fees that programmers ask for are reasonable or exorbitant.

AMOS HAS BECOME established as the best language for novice programmers on the Amiga, but there are still plenty of people who find it too difficult to get a grip on. Enter *Easy AMOS*, with some advanced features missing and a couple of extra, specially designed features for people starting from scratch. So if you've always wondered just what this programming lark is all about, this disk is the place to start!

Programs are best thought of as a list of instructions for the computer. It goes down the list, obeying the commands, perhaps jumping to a different part of the list at different times. But it always starts at the top and usually finishes towards the bottom.

Rather than just give you the demo, the programmer of the *AMOS* series, Francois Lionet, has included quite a few little sample programs for you to look at and muse over. None of them produce arcade-quality graphics or millions of sprites flying all over the place, but *AMOS* isn't about speed. It's about being easy to understand - much easier than machine code or C.

Also understand that this is just a demo. If you manage to write any programs of your own, then you won't be able to save them to disk. Also, the Help feature doesn't work, and neither do some of the others. It's just there to help make up your mind about whether or not *Easy AMOS* can help to teach you how to program the Amiga to do what you want it to do.

Finally, to stop an *Easy AMOS* program running, you have to press the Esc (short for Escape) key twice. Pressing it once puts you into Direct mode, from where

Easy AMOS demo

EUROPRESS/JAWX PAL ONLY

you can enter *Easy AMOS* command directly. For people who already know the Basic language on which *AMOS* (and so *Easy AMOS*) is based.

Oh yes, sometimes the Esc key doesn't work, in which case you should hold down the Ctrl key, then press C. Again, that puts you into Direct mode, so you should hit Esc to go back to the main editing area.

The main difference, by the way, between *AMOS* and *Easy AMOS* is that *AMOS* was designed to write arcade games using sprites with lots of frames of animation. To handle this simply, without writing lots of commands to change each sprite frame by frame, a separate language called *AMAL* (Amos Animation Language) was included. This gave a simple method of specifying sprites, which animation frames to use and the rate of change on a single line.

Due to *AMAL*'s inherent simplicity, a lot of people had immense trouble working with it, so it's been taken out of *Easy AMOS* (and so the demo as well). Instead, a number of options have been included to help you learn how to use the *AMOS* system - the most powerful of these, the Tutor function, has been included in the demo. It's best to learn to walk before you attempt to run. No pun intended.

CDTV OWNERS!

If you own a CDTV device, you're probably still in the shop wondering whether the disks work with your machine. Yes they do! If you have a floppy disk drive connected, of course. Both the *SpectraColor Jr* and *Easy AMOS* disks work fine, with one proviso.

Quick Money is designed for two players, and so you need a mouse and a joystick, or two mice, or two joysticks. However, you cannot connect these to a CDTV without a Game Brick device. Everything else causes no problems - but do remember to press the Joy/Mouse button after loading *Microbes* or *Croak!*.

The reason for this incompatibility seems (I'm not totally sure) the crunching program we used to compress the disk. Now we have a copy of *PowerPacker Professional 4*, that seems to have cured the problem. Our sincere apologies to all those frustrated CDTV owners - from next month we'll check for Kickstart 1.2 as well.

HOW TO LOAD PROGRAMS



The most difficult part of loading the example programs into *Easy AMOS* is getting to the Load button. Move the mouse pointer to the top of the screen, press the right mouse button and keep it held down. The usual menu options will be replaced by a different set. Move the mouse pointer to the Load button, and click the Left button. Let go of both mouse buttons and then a load requester will appear.



All of the example programs are kept in a drawer called EA. It should be the first drawer to appear (all drawers are marked with an asterisk, so it's labelled as *EA). Move the mouse pointer to it and double click with the left mouse button.



The contents of the EA drawer will appear. Move the mouse pointer down to the file called *Space Dodge.AMOS*. Then double click on it, again with the left mouse button - if you want to see a different example, just click on a different name. The file requester will disappear.

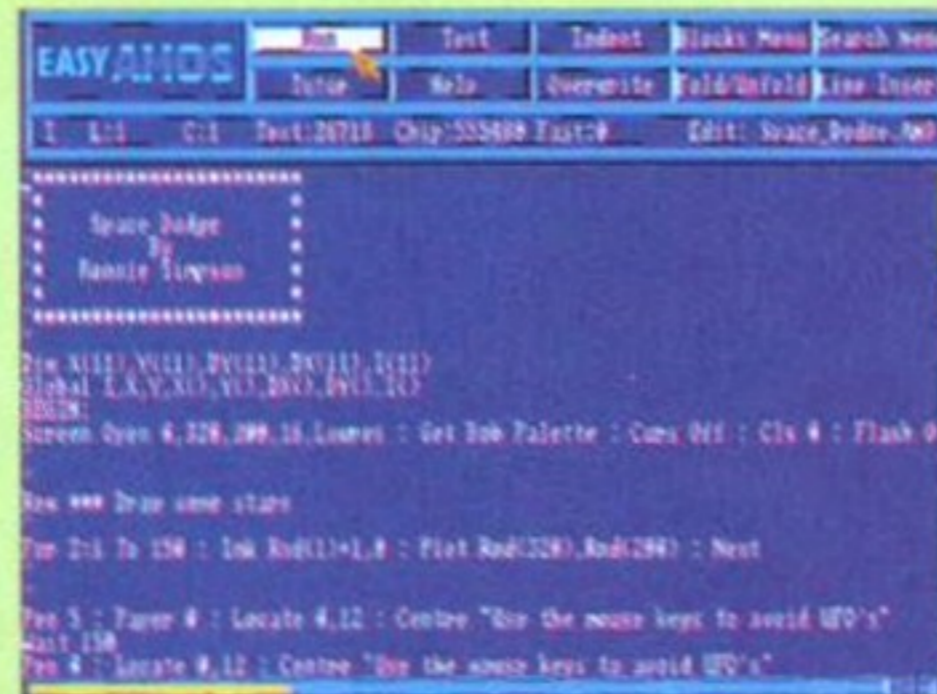

Once the example program has loaded, you will see a listing of it going down the screen. Simply move the mouse pointer to the button marked Run, and click with the left mouse button. The *Space Dodge* example program will then run.

THE TUTOR FUNCTION

The most useful ability of *Easy AMOS* is probably the Tutor. This lets you view the output of a program in a small window, and displays the commands while they are being executed. So you can view the program running, and see just how it's generating the screen display, and the commands used to play sounds as they are being played!

The traditional way of learning in Basic (which is more or less the language that *AMOS* is) was to type in program listings from magazines. Unfortunately, the growing size of computer systems' memory means that it's not really viable - imagine a computer magazine with a fifty page listing! People made many typing errors when typing too.

The Tutor function is designed to fill the gap left by the absence of computer listings magazines. To use it, load in one of the example programs as per the above instructions (they're all in a drawer called EA, remember) and click on the Tutor button towards the top centre of the screen. This will bring up a separate screen.



Here's the *AMOS* Tutor in action. The four play buttons, from left to right, do the following. The first one runs once Amos command each time it is clicked on with the left mouse button. The second runs a complete line. The third does a whole block of functions, while the fourth quits the Tutor and runs the program normally.

QUICK MONEY

BEN CAMPBELL ■ PAL/NTSC

This is a fairly easy, two-player, blasting game. Broadly speaking, the idea is to move your droid around the different mazes, shooting at everything, your opponent and the computer drones. Simple enough for most people.

Control is fairly simple, and can be either joystick or mouse for either player. You set the game up at the beginning, pressing the function keys to decide who plays with which type of controller. You can also choose between PAL (Europe, Australia and New Zealand where this game originates from) or NTSC (North America, parts of Latin America and Japan) video displays. Pressing the Esc key on this screen will quit the game.

Each player has a score and a shield. By shooting the drones, your score goes up. However, when a drone moves onto you (or your opponent shoots you) your shield goes down - when it reaches nothing, you're dead!

The good news is that the shield can be revitalised by trading in points scored for energy. You do this by moving over the square icon - there's one in each maze, although sometimes it's a bit too close to the icon with arrows on it for comfort. That's where the computer drones pop out of, you see. A lot of people find the split screen confusing - the playing area is split into two, and the different areas move independently. The trick is to watch your screen most of the time, taking a look at the other only player's occasionally.

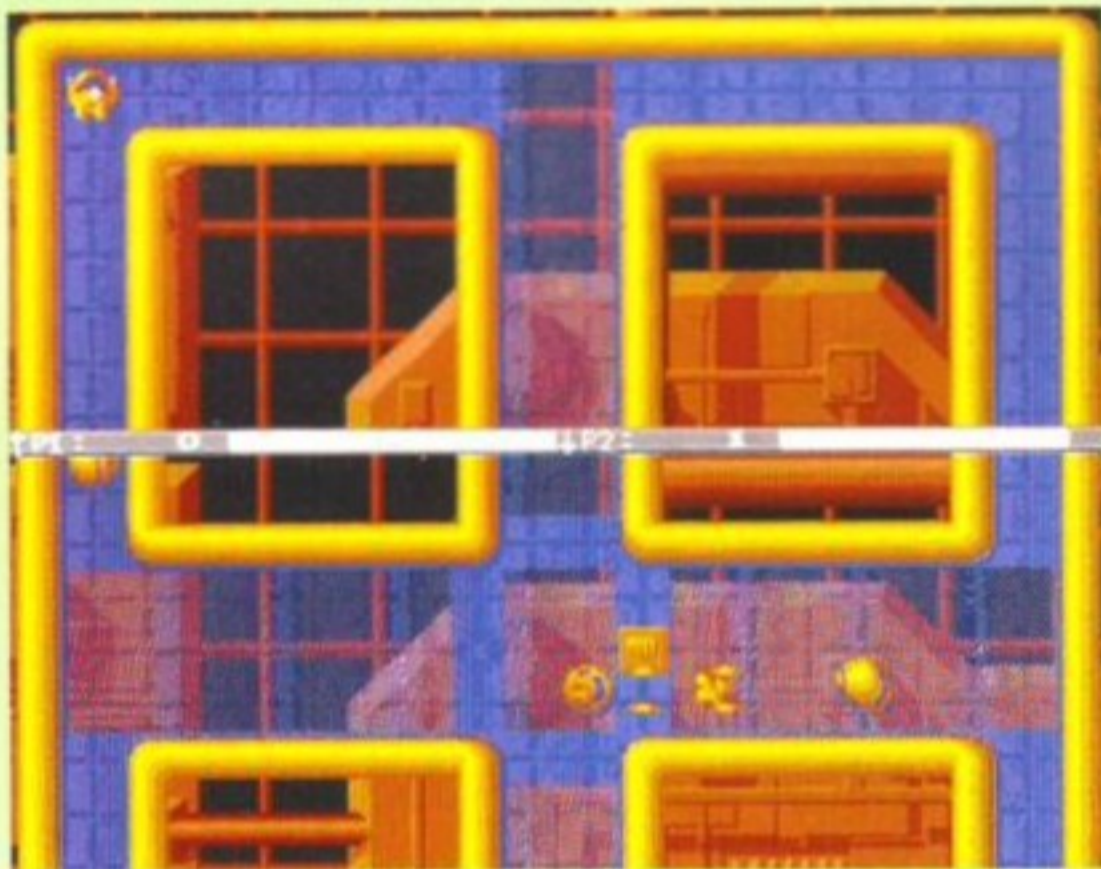

Playing *Quick Money* well relies on a bit of though as well as reflexes. It usually pays to keep half an eye on what the other guy is doing. If he's dead and you're behind on points, concentrate on blasting as many drones as you can to make up the difference.

CROAK!

SELWYN STEVENS ■ PAL ONLY

Some of you may recognise this game because it's a fairly close clone of an old arcade game called *Frogger*. You'd be hard pressed to find a *Frogger* machine that still works, so it's nice to see a version on the Amiga - all right, I admit we did put one on *Amiga Format 25's* Coverdisk, but this one has a number of extra features.

The idea is really, really simple. With a joystick, you have to hop a frog over a road and across a river, in order to reach the holes at the top of the screen. Each hole has to have a frog in it before you finish the level - the main difference between the levels is that the road traffic goes faster and there are fewer logs across the river. Also, a chicken clucks up and down the safe middle zone, making it not so safe.

As well as the logs floating down the river, an occasional family of turtles can be used to hop across. Be a bit wary of them though, because they have a tendency to dive at the most inconvenient times. Only hop onto a turtle if there's a log nearby to escape onto.

Oh yes, *Croak!* can be played in two-player mode, but only if you have got two joysticks. It's a straight race then to fill up the holes at the top of the screen - the second player has a yellow frog, so you don't get confused as to who's who on screen.



It's so very easy in theory, and so finicky in practice. Hopping your frog across the road and over the river, that is. It's so infuriating to get all the way across and then miss the hole!

HUNTER III

Neil Boffin ■ PAL/NTSC

Hunter III is a sample ripper. It has three main uses; it can scan memory for sound samples, to see if any have survived a reset (usually they do); it can scan memory to nick sounds out of programs that multitask with *Hunter III* (very few games multitask, but plenty of sound player programs like *MedPlayer* or *IntuitTracker* do); and it can also scan through disk files for samples, even ones crunched with *PowerPacker!*

Before you get it running, remember that it can only look for things that have already been running in the Amiga's memory. The best way to do this is either play a game before running the Coverdisk, or have a quick game of *Quick Money* and then quit out of it from the titles screen. Then double click on the *Hunter III* icon itself.

When running, the program has a control panel which is similar to that found on a tape recorder. You can fast forward, rewind, play and stop. It also displays information within little windows, for things like where in memory it starts playing from, how long it plays for (the length of a sample) and how fast it plays it - playing a sample slower makes it sound lower in tone, and faster raises the tone.

When you click in a box to type, remember to press the Del key to delete all the information that's already there - a mistake many people made when setting the page size on *Page Setter*.

Right, by now you've probably gone ahead and clicked on the play button, only to hear high-pitched screeching coming out of your computer. That's how normal computer programs and pictures sound when you play them. If you ever owned a computer that loaded programs from tape, you'll recognise the similarity.

Down to your first memory scan. Click on the box labelled start, delete what's there (by pressing the Del key) and enter a fairly low value - let's say 10,000. Click on the box marked length, delete what's there, and type in 450,000. The majority of Amiga's only have 512K of chip RAM for storing samples, and trying to get the computer to play an area of memory that doesn't exist will cause problems. Adjust the volume downwards, then click on the play button.

Screech, scream, burr, hummm... then you'll hear something recognisable, either a sound effect or instrument from the game. Then the howling will return.

Adjust the start position upwards, and decrease the length, then play again. You'll get less of the

computer noise and (hopefully) more of the sound sample. Keep adjusting the start and length until you can only hear the sound sample. Click on the save button and have a blank disk handy. Congratulations, you just did your first sample rip!

I could go on in this vein, explaining absolutely everything that

this program is capable of doing, but all the information is mostly contained in the Readme document on the Coverdisk anyway. Have a browse through that and keep playing with the program until you're happy with it. Need some samples from a PD demo or game? Now you can get them.

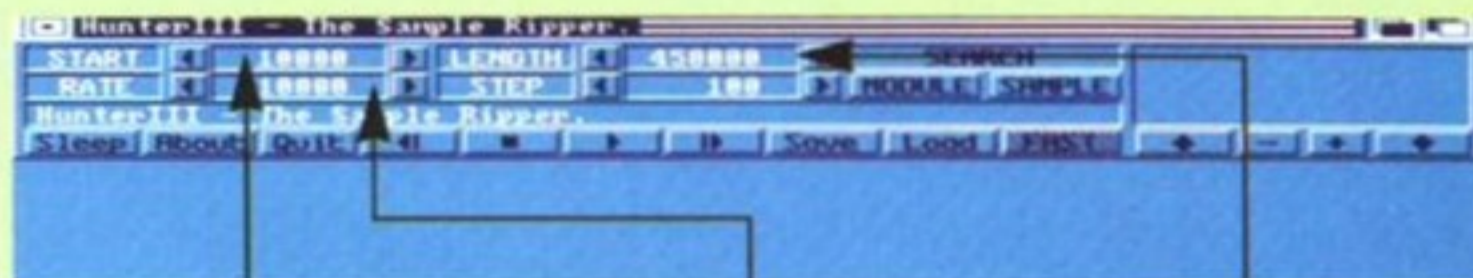

The Start value is important - it's where in memory the computer will attempt to play sounds from. Values down to 0 are fine, although you are unlikely to find any samples earlier than 10,000.

This is the number of samples the Amiga will play each second. If the length is 150,000, and the Rate is 10,000, then it will take 15 seconds to play that much memory. Rates over about 30,000 are pointless.

The Length is nearly as important as Start. If it's too big then you're computer will play samples from memory that don't exist (this can crash it) and if it's too small then you may miss sample data entirely.

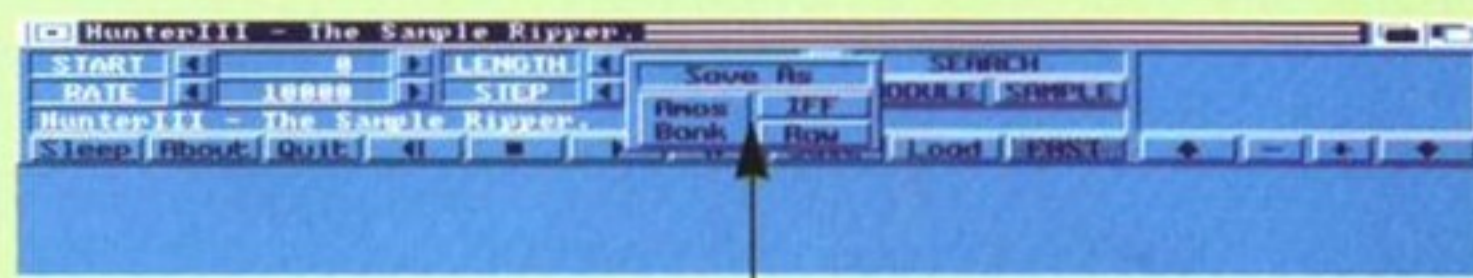

When you click on save, this requester box appears, asking if you want to save in IFF, RAW binary or AMOS bank format. If you're not sure which, IFF is the best all rounder, although RAW samples sound better. Click on 'Save As' to abort the save.

Using Your Coverdisk

1. Always write-protect your disk. Move the tab so a hole is showing.
2. Copy the Coverdisk and use the copy, not the original. This may sound like a complicated task, suitable only for techno buffs, but it's surprisingly simple to do, just follow the simple instructions for copying the disk which are given below.
3. Read the instructions when using the programs.

Backing up your Disk

There are two ways of making a copy of your disk, and this is the easy one. Don't be daunted by the fact that you need to use the Shell or CLI: it's actually a lot easier than you might think. Just follow these simple steps...



1 Load your Workbench disk. Open the disk, find the icon that says Shell or CLI and double-click on it.

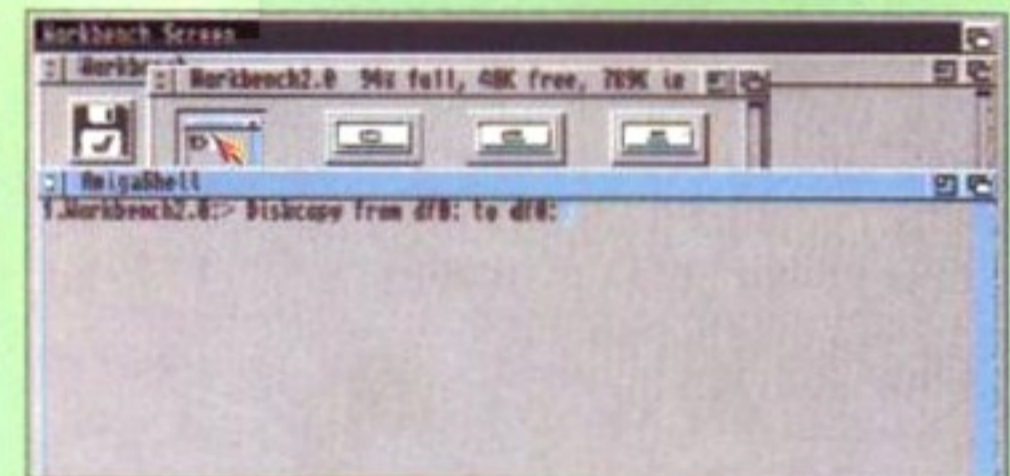

2 When the Shell window appears and the drive light is out, type in:
Diskcopy from DF0: to DF0:
and press the Return key.

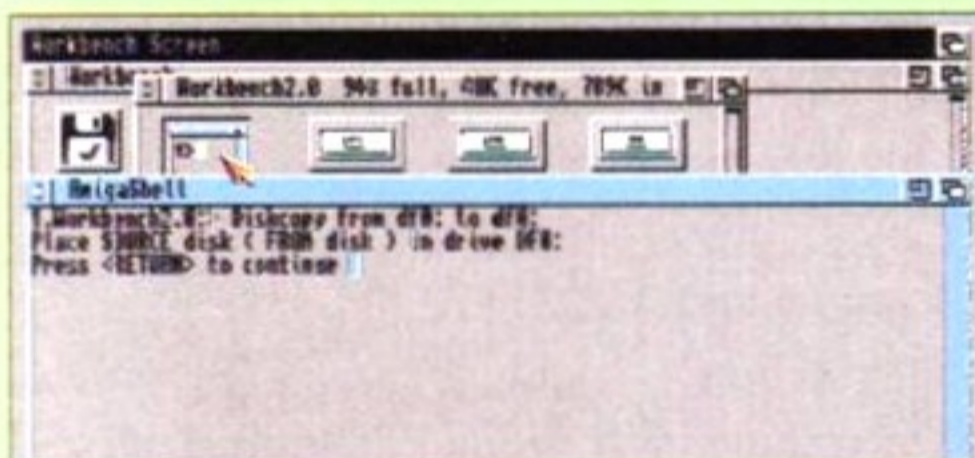

3. The Amiga will now ask you to insert the 'source' disk. It means the disk you want to copy, so put the Coverdisk in the drive and press the Return key.

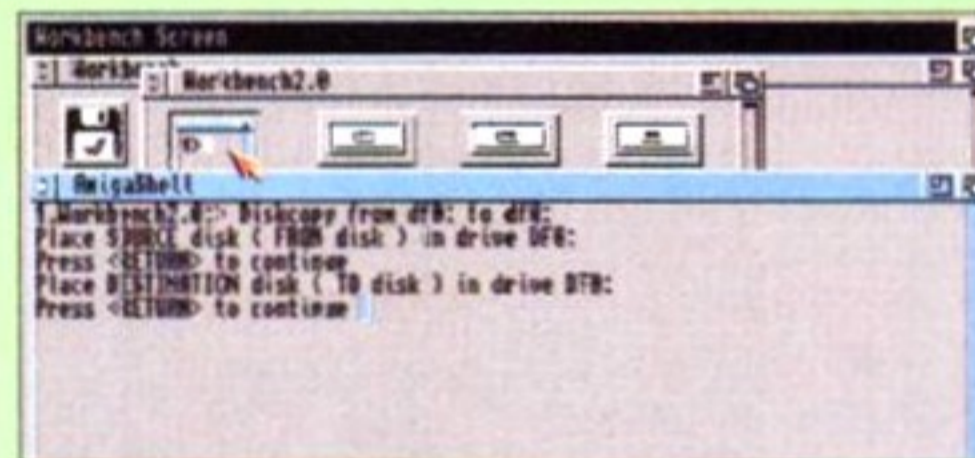

4. Wait for a while and it will read all the information off the Coverdisk, telling you how far it has got. Then it will ask you to insert the "Destination" disk. Put the disk you want to copy your Coverdisk onto in the drive and press the Return key. Note that the disk does not need to be formatted already.



5. Put the source disk and destination disk in a couple more times when the Amiga asks for them. When it says "Diskcopy Finished" just type in:
endcli
to get out of the Shell or CLI. You may have to put the Workbench disk in again. Now your copy is ready!

DISK PROBLEMS?

If you have a problem with the disk – and you're sure the disk is in full working order – then you may need a little help. If you ring us on any Tuesday, and ask to speak to Pat McDonald, he will do his best to help you. Please understand, giving this sort of advice is time-consuming and we are very busy people, so only call if you really have to and do be considerate if we can't talk to you just then. If the problem is particularly complex it is better to send it to us in written detail. It will then be dealt with in the Workbench pages of the magazine.

BE CAREFUL!

We have done our best to check that the programs on the **Amiga Format** Coverdisk are simple to use and have no known viruses. We cannot usually answer complex telephone queries on the software (see the Disk Problems? box) and we do not accept liability for any consequences of using the numerous programs that are on the disk.

COPYRIGHT

Unless it is specifically stated, the programs on the Coverdisks are not in the Public Domain and the copyright remains with the author of the program.

Because some of the programs on the Coverdisks are not PD, selling or distributing them without the author's specific permission is against the laws of copyright.

Disk not working?

We duplicate over 440,000 disks every month. Out of all those, obviously a few will be faulty. If the disk or any of the programs will not load or run properly, there may be a problem. Don't panic!

First try using the **DiskDoctor** utility on your Workbench disk to rescue it before sending it off for a replacement. In full details of **DiskDoctor** can be found in the user's manual that came with your machine.

However, if your Coverdisk is in fact faulty, you should send it back **INCLUDING A STAMPED, ADDRESSED ENVELOPE** for a free replacement within one month of the cover date to:

**Amiga Format June Disk
Disk Copy Labs
Unit A, Westmarch
London Road
Daventry
Northants
NN11 4SA**

Remember to include that stamped, addressed envelope!



**PGA TOUR® GOLF - NOW WITH
3 NEW KILLER COURSES
TO SINK YOUR TEES INTO.**

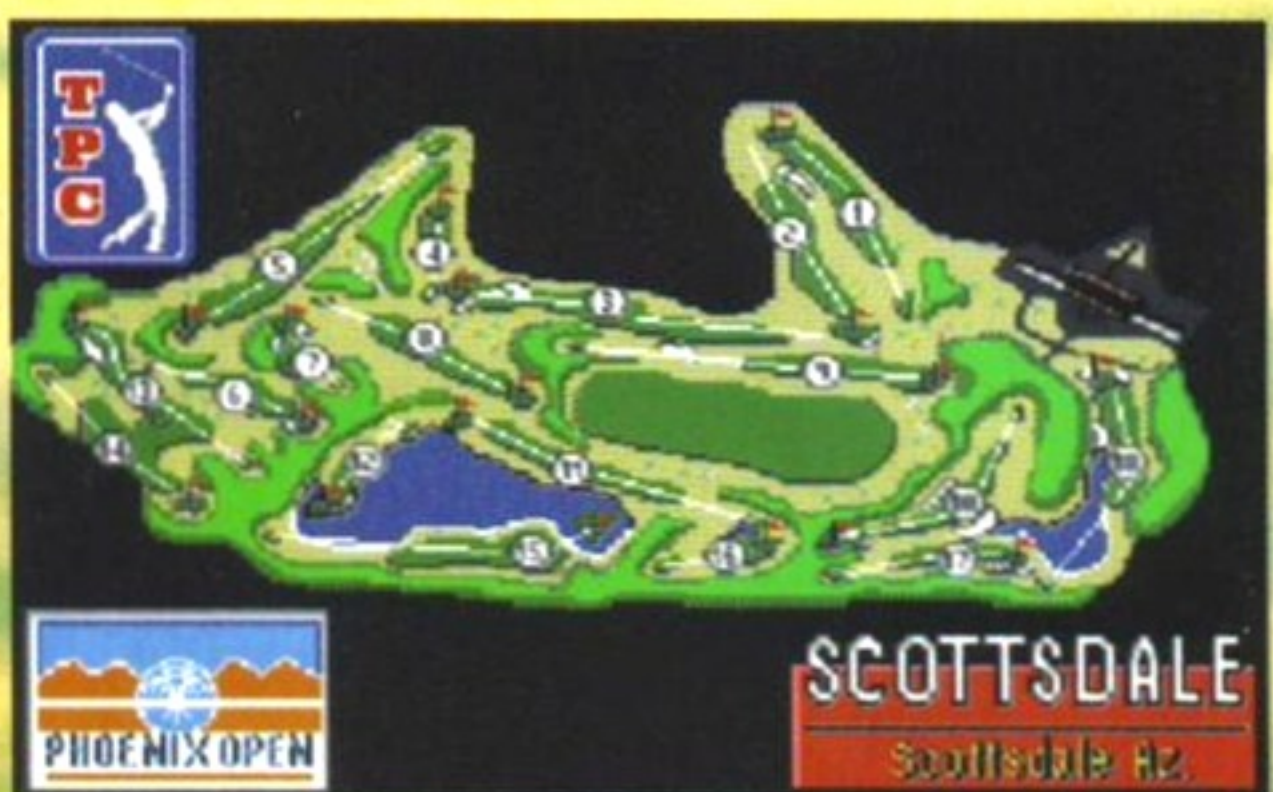

TOYS IN THE ATTIC EUROPE

Perhaps you were getting just a touch too big for your brogues because you were up there with pros like Azinger and Stadler out at Avenel, Sawgrass, Sterling Shores and PGA West Stadium?

Instead of retiring smugly to the 19th Hole for a few rounds of Scotch, it's time for a brand new challenge in the shape of three new tournaments: The Honda Classic, The Phoenix Open and The Federal Express St. Jude Classic.

Electronic Arts present three more authentic PGA TOUR courses - TPC at Eagle Trace, TPC at Southwind and TPC at Scottsdale.

Plus, you get all the features that have made **PGA TOUR Golf** one of the best selling computer golf programs ever: fly-by

course previews, hints from the pros, TV-style coverage and realistic crowd reactions that reflect your best shots.... and biggest duffs.

So don't putt around. Get your clubs out and prepare for three new 18-hole challenges.

You can find them in the new **PGA TOUR GOLF PLUS** edition, which also contains the PGA TOUR Golf program and the four original courses.

Or, if you already own the original PGA TOUR Golf program, find the three new courses in the **PGA TOUR Golf Tournament Course Disk**.

PGA TOUR GOLF PLUS Edition
Amiga £29.99 IBM/PC £34.99
PGA TOUR GOLF Tournament Course Disk
Amiga £14.99 IBM/PC £14.99

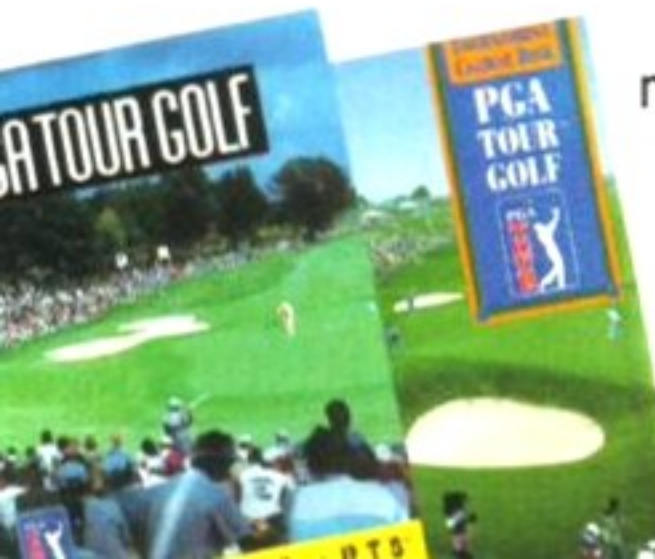

TPC, Tournament Players Club, The Honda Classic, The Phoenix Open, The Federal Express St. Jude Classic, and the PGA TOUR and their affiliated logos are registered trademarks.



Electronic Arts, Langley Business Centre, 11-49 Station Road, Langley, Berks SL3 8YN, Tel: 0753 549442, Fax: 0753 546672

The **AMIGA** Collection

FORMAT

No.3 RRP £60
Spectracolor Jr
from Oxix-Aegis**COMPLETE HAM PAINT PROGRAM!**

You might have Deluxe paint II or III, but can you paint using all 4,096 of the Amiga's colour at once? With this you can; featuring unique blend setter and 'wrap on shapes', it's amazing!

● A 500 Plus Compatible ● Requires 1 Mb ●

To the artist ...a son

Continuing the Amiga Format Collection, we bring you Spectracolor Jr – a full-featured HAM paint-and-animation package to add to your Amiga toolkit. **Maff Evans** highlights the key features of this powerful artistic program.

THOSE OF YOU who bought the Christmas issue of *Amiga Format* will no doubt have dabbled with the paint program given away on the cover. This month's Coverdisk contains more ammunition for the Amiga artist to add to their arsenal in the shape of *Spectracolor Jr*.

So why, when we've already given you a paint-and-animation program, have we included another Amiga art program in the *Amiga Format* Collection? Well, *Graphics Workshop* is all very well when you want to work in modes up to 64 colours, but what about HAM mode? What do you do when you want to create artwork and animation with up to 4,096 colours? This is where this month's addition to the *Amiga Format* Collection, *Spectracolor Jr*, comes into play. The program contains all the features you'd expect from a paint package, all specially constructed to allow you to work with all of the Amiga's 4,096 colours, as well as the ability to create animation pages to bring your HAM pictures to life. The program also contains some specialist functions which can only be used in HAM mode, and so will take a little getting used to. On the following pages we will try to give a rough outline of the various functions, explaining some of *Spectracolor*'s unique features along the way.

GETTING STARTED

Spectracolor Jr will work on a standard Amiga (even a 512K A500), but additional memory (at least 1Mb) is definitely recommended for creating animation frames or working in interlace mode.

Getting up and running is pretty straightforward. To load the program, power up your Amiga and insert the Coverdisk containing *Spectracolor Jr* into the internal drive. After a while, a Workbench screen will appear containing the disk icon. Double click on the icon to open the disk window, then double click on the *Spectracolor Jr* icon (the one with the paint palette, mouse and monitor) to load the program. A blank screen will appear with the *Spectracolor Jr* Fast Menu at the top. You're then ready to start painting.

In order to conserve memory, *Spectracolor* only loads the sections of the program that it needs at any one time. For this reason, we recommend that you leave the disk in the drive as much as possible. Only remove the disk when you want to load or save picture and animation files (or preferably use another drive), otherwise you will get nasty messages appearing telling you to replace the original disk. Not a disaster, but a little annoying when creating a masterpiece!

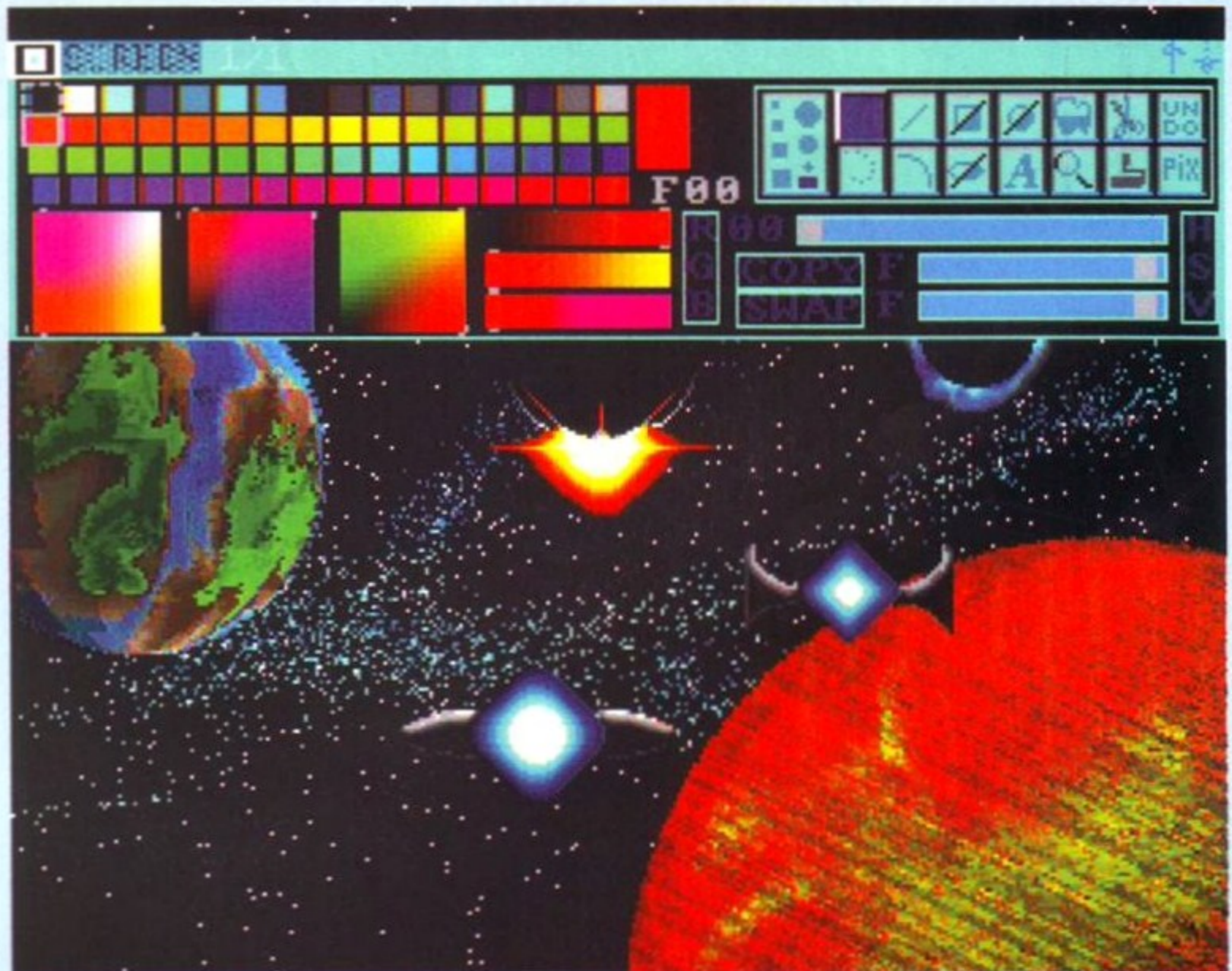

This picture was created by manipulating brushes using *Spectracolor Jr*'s impressive Wrap-on feature – and there's no restriction on the number of colours.

It doesn't stop there...

Once you've had chance to experiment, and discovered those artistic talents you never realised you had, on this month's Coverdisk, you'll have realised *Spectracolor Jr* is a very easy-to-use paint program. And if it's whetted your appetite, selecting from 4,026 possible HAM colours, it doesn't have to stop there. *Amiga Format* have negotiated a very special offer for readers who want to get hold of *Spectracolor*'s advanced features. The full featured upgrade includes the following innovations:

- Brush Wraps
- Advanced Paint Modes
- Air Brush
- Brush Animation – including curved path animation with fades and simple morphing.

But the upgrade doesn't stop there. You'll also receive a program disk, plus a sample tutorial disk and an in-depth 300-page manual that will take you through countless examples and techniques showing you precisely why *Spectracolor* is such an excellent paint-and-animation package. So to upgrade now send a cheque for £31.40 payable to Future Publishing Ltd, plus your *Spectracolor Jr* Coverdisk, to the following address; **Amiga Format, Spectracolor Offer, Future Publishing, Somerton, Somerset TA11 7BR.**

The Fast Menu

The Fast Menu holds all the main drawing and colour-editing controls. It can be turned off by selecting the Close gadget in the top-left corner or toggled on or off by clicking the right button in the top-right of the screen or by pressing F10 or Help.

TITLE BAR This holds information such as the current page and the drawing mode. You can move the Fast Menu by clicking on the title bar, holding the left mouse button or by dragging up or down. By dragging, whilst holding on the word SCREEN, you can move the entire screen up and down.

THE COLOUR PALETTE
This is where you select the colour with which to paint. The top row contains the Base Colours, which will be explained later. To select a foreground colour, click on the required colour in the palette with the left button. Use the right button in the same way when you select a background colour.



FOREGROUND/BACKGROUND COLOURS
The current foreground colour is shown in the left-hand box and the background colour is shown on its right. You can select colours by clicking in these boxes and then clicking on a colour in your picture with the relevant button.

BUILT-IN BRUSH BOX
You can select a built-in brush from here by clicking on it with the left button.

THE TOOL GADGETS
These buttons are used to access the various drawing tools. For an explanation on these, see the Tool Gadgets section.

EXTENDED FAST MENU
To open and close the Extended Fast Menu (including the colour editor), click on the two arrows at the right-hand end of the title bar. This is the section where all the colour editing functions are found (see the Setting Colours opposite for an explanation).

The Tools

These are the buttons to click on for the various drawing tools. You can also use key short-cuts, which are listed next to the icons. Use the left hand button in each mode to draw with the foreground colour and the right button for the background colour.

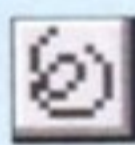

FREE DRAW TOOL (D)
This is the default tool and allows you to draw a freehand line with the current brush. Clicking a second time (or pressing D twice) allows you to draw a filled shape. By holding the Ctrl key while drawing, you can go back and edit parts of the line which aren't quite right.



DOTTED FREEHAND DRAW (S)
Allows you to draw a freehand dotted line. Clicking again (or pressing S twice) switches to the airbrush tool. To set the size of the airbrush, select it with the right-hand button, then drag the area to the required size.

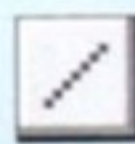

LINES (V)
This is used for drawing straight lines. Click on the start point and drag out the line, releasing the button to stamp it down. Clicking again (or pressing V twice) allows you to draw lines surrounding an area, which will be filled when you click on the start point.

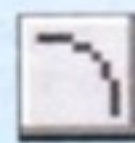

ARC (Q)
Works like the line tool, except you can bend the line to form a curve.

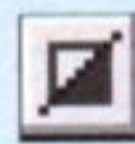

RECTANGLE (R)
Allows you to draw a rectangle. Click on the bottom section of the icon (or use Shift-R) to switch to filled rectangle mode.



ELLIPSE (E)
Allows you to draw an ellipse on screen. Click on the lower section of the icon (or use Shift-E) for a filled ellipse.



CIRCLE (C)
Allows you to draw a circle on screen. Click on the bottom half of the icon (or use Shift-C) for a filled circle.



TEXT (T)
Allows you to type text in the current font. Click on the icon with the right button to call up the Load Fonts requester.



FILL (F)
Fills an area of the screen with colour. The first mode is Background fill, which will fill until it hits another colour. Clicking again (or pressing F twice) selects Boundary Fill. To use this, you must next click on a section of the boundary to the area you want to fill. The program will now fill until it hits that colour.



MAGNIFY (M)
Opens a window containing a magnified view of the area that has been selected. On the window are tools to change the size of the window and the magnification which can also be changed using < and >.

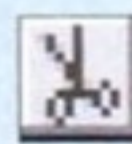

CUT (B)
This allows you to cut out an area of the screen to use as a brush. The first option is the scissors tool. This allows you to cut out a rectangular area. Clicking (or hitting B) twice selects lasso cut, which works in the same way as a filled freehand shape. Clicking (or hitting B) three times allows you to cut out a polygon area (in the same way as drawing a filled polygon).



BRUSH (SHIFT-B)
Restores the brush to the last one used.

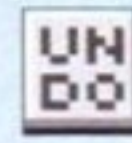

UNDO (U)
Undoes the last drawing operation.



PIX
Allows you to 'pixellise' areas by drawing with the brush. Use '0' and '-' on the keypad to change the level of pixellisation.

CONTROLLING SPECTRACOLOR JR

All the options and control functions in *Spectracolor Jr* can be accessed via the main control panel (called the Fast Menu) and from one of the six pull-down menus. Some functions open up further windows for special functions. These will be detailed later.

THE MENUS

The menu options are selected by using the right button with the pointer at the top of the screen. You can also use key short-cuts (listed in the menus) to select some options.

THE PROJECT MENU

Clear
Clears the screen to the current background colour.

Load
Calls up the file requester to load a picture. You can type in a filename or select it from the main window. You can select '*. *' to display all files or '*.PIC' to display only files with the extension .PIC.

Save
Saves your picture with the current filename.

Save As
Opens a requester similar to the Load requester for saving a picture.

Save Anim
Allows you to save a number of animation frames. You set the frames to save using FROM and TO as well as whether to save the anim as a continuous loop (some animation programs need this to be set).

Delete
Calls up a requester for deleting a file.

Print
Calls up a window for printing the current picture using the current Workbench printer prefs.

Setting Colours

COLOUR SELECTION SQUARES

These show cross-sections of a three-dimensional colour 'cube', with white dots showing the location of the current colour. You can select a colour to use from any square by clicking on it.

HSV SLIDERS

These are used to edit the hue (colour shade), saturation (amount of colour) and valence (brightness) of the currently selected colour.



THE SPREAD GADGETS

You can create a spread of colours using these. Select the first colour, click on RGB gadget or HSV gadget and set the target colour to create the spread. Note the subtle differences between an RGB spread and an HSV spread.

RGB SLIDERS

These allow you to edit the amounts of red, green and blue in a colour. The white dots show the current value of each slider, with the bar displaying the spread of shades currently available on each colour.

THE COPY GADGET

Allows you to copy the current colour to another register.

THE SWAP GADGET

Swaps the current colour with that of another register.

Fast Menu Calls up the Fast Menu

Base Colors

Calls a sub-menu allowing you to select where the 16 'Base Colours' (which *Spectracolor* uses for HAM calculations) should be taken from, along with functions for configuring the picture to use the new colours.

Alternate

Accesses a menu used for moving to, or creating, new screens to use as spare pages or animation frames. The command to play an animation is also found here.

Font

Calls up a menu for loading fonts, setting the type style or freeing memory used by a font.

Video

Displays the screen without any menus or windows. You can press I in this mode to turn interlace on and off, which is useful for recording animations to video.

About

Displays information on *Spectracolor*.

Quit exits the program.

THE PREFS MENU

Screen Mode

Sets the screen mode to use for painting.

Exact Color

Uses the current colour as it stands and affects adjacent pixels, rather than using the base colours to affect the current colour.

Keep Undo / Keep Brush

Allows you to use the brushes and Undo command from the Fast Menu. If memory is low, you may want to turn these off to save memory.

Fast Brush

Allows you to draw more freely with a cut-out brush. The function requires more memory than normal brushes and only works with Trans mode off.

Clear to First

Clears the screen to the first colour in the palette.

Load Prompting

Switches the 'Yes/No' panel which asks for size changes when loading on or off.

Coordinates

Toggles a coordinate display in the Fast Menu title bar.

Workbench

Allows you to open and close the Workbench.

Follow Mouse

Drawing functions follow the mouse path exactly).

Mouse Speed

Sets the speed of movement of the mouse pointer.

Screen Offset

Move the position of the screen display.

Save Prefs

Saves the current option settings in the Prefs menu.

THE BRUSH MENU

Load

Calls up a requester for loading a brush.

Lighting

The Luminosity window is used to set up lighting effects to use with the Wrap functions, emulating a light source for the 3D effect.

LUM ON/OFF

Switches the Luminosity function on or off.

DIRECTION

Allows you to move the light source point in an imaginary hemisphere around the subject.

INTENSITY

Adjusts the brightness of the light source.

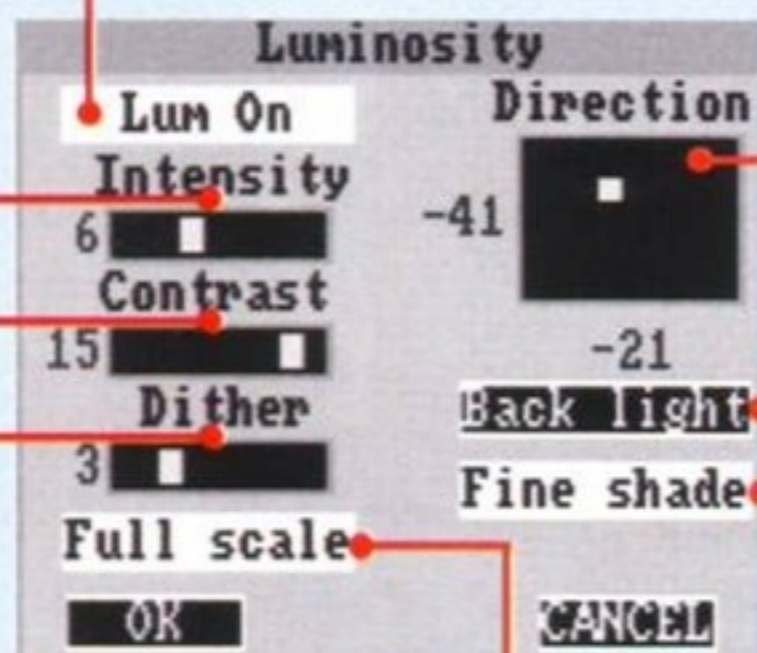

BACKLIGHT This sets whether the light source is in front or behind of the subject (the values in the direction panel change from 0-90 to 90-180).

CONTRAST

Adjusts the contrast between the light source and the subject.

FINE SHADE

Adds extra smoothing routines to the rendering process. This may not be useful on some objects.

DITHER

Sets the amount of dithering to be carried out when rendering a lit object.

FULL SCALE

Defines whether to use the whole range of shades across an object.

Continued overleaf

Save As

Calls up a requester for saving a brush.

Trans

Turns the brush's 'transparent background' option on or off.

Solid

Turns the brush into a silhouette in the current foreground colour.

Flip

Flips the current brush horizontally or vertically.

Resize

Accesses a menu containing options for changing the size of a brush.

Rotate

Allows you to change the angle of the brush.

Wrap On

This really is one of the most interesting and novel features of *Spectracolor Jr.* By using this sub-menu, you can wrap the current brush onto a number of shapes. All of these create a solid, 3D representation of your brush using lighting effects from the Luminosity function. All the functions are carried out by selecting the required shape and dragging the shape out to the required size, with the exception of the cube and contour functions.

The 3/4 cube allows you to wrap the brush around a cube while the *3 option places the brush on each face of the cube. Dragging the mouse in the cube function changes the size and orientation of the cube for optimum effect. The contour function creates a 3D contour map (which can be tilted) based on the brightness of various areas of the brush.

Special

This allows you to access a number of special brush manipulation functions, including brush bending, stretching and twisting (forming a spiral).

Tilt

Allows you to move and tilt your brush in 3D space. By selecting this function and dragging the brush around, you can change the pitch, roll, yaw and distance of the brush.

Lum

Brings up the Luminosity requester (see 'Lighting' section).

Remap

Restores the colours of your brush if its palette is different from the picture.

Free

Removes the brush and frees all of the memory that it previously took up.

THE SPECIAL MENU**Cycle Draw**

Allows you to draw with the colours cycling through the current palette between your selected foreground and background colours.

Stencil

This is used for creating and using 'masks' which protect areas of your picture. A stencil is defined in the

Blending Gradients

You can create gradient-fill effects to use in the Blend function in the Modes menu, creating horizontal blends, vertical blends or a combination of the two.

BAK This button, when set, carries out the blend using the normal colour definitions.

EXAMPLE BLEND WINDOW This shows a square illustrating the effects of the current blend settings.

DITHER Sets the amount of dither to use when rendering a gradient blend.

GRD This button renders a blend using a spread of colours between the foreground and background colours.

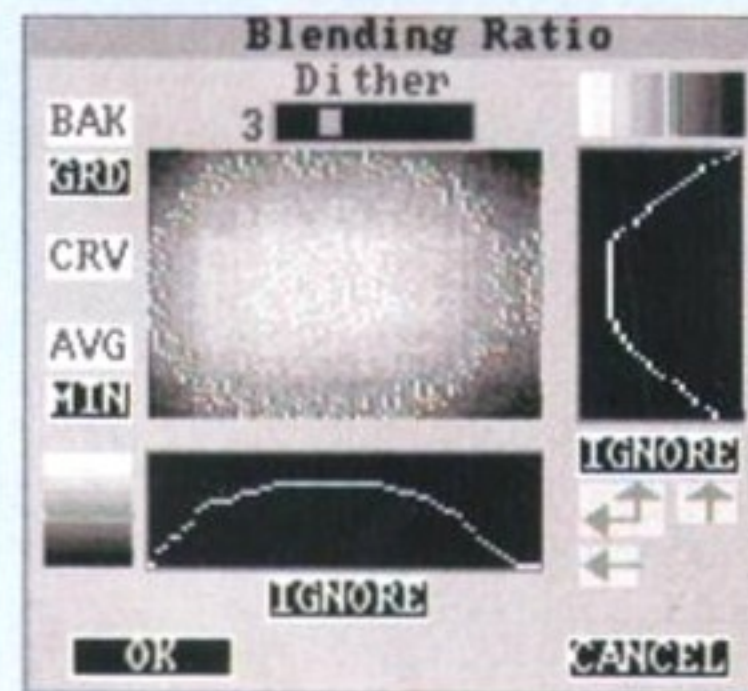

HORIZONTAL GRADIENT BOX You can draw a free-hand line here to define the shading to use in the horizontal element of your fill.

CRV Sets the blend to use a graduated curve when rendering a blend. When switched off, the blend will use a 'pyramid' effect using straight line gradients.

Swap and Copy Gadgets The arrow pointing horizontally and vertically swaps the curves in the two boxes, while the single arrows copy the other curve into the selected box.

AVG Sets the blend to use an average of the two axes' curves and the background.

VERTICAL GRADIENT BOX You can draw a free-hand line here to define the shading to use in the vertical element of your fill.

IGNORE GADGETS When these are selected, the blend function will only carry out a gradient blend in one axis.

MIN When this is selected, the lowest point shade of the two curves and background will be used for rendering.

same manner as drawing a filled freehand shape. You can invert a stencil to protect everything but the marked area.

Grid

Allows you to drag out a box defining the proportions of a guide grid. With a grid on, the mouse pointer will snap to the grid's corners.

Shadow

Contains options for adding shadows in the current background colour (complete with effects) as you draw. You can define the offset or use the Relative (in conjunction with the Define Base Size function) to create a shadow offset relative to the size of the drawn shape.

THE MODES MENU

There are two of these Modes menus, one for the background and one for the foreground. They are both the same and carry out the same functions (albeit independently) on each.

Normal

Draws normally in all functions.

Blend

Blends the current brush (including custom brushes, built-in brushes and filled shapes) with the background in all drawing operations.

Set

Opens the blend requester for defining gradients to use with the blend function (see Blending Gradients box for more information).

Add

Adds the value of colours in the current brush to background colours as you draw, creating new shades.

Subtract

Works in the same way as the Add function, except the values are subtracted.

Maximum

Compares the RGB values of pixels in a brush with those of the underlying background and changes the values to the maximum as you draw. For example, if a brush pixel contains a higher RGB value than the background pixel it covers, the background colour will change to that of the brush pixel.

Minimum

Works in a similar way to the Maximum tool, except that the minimum values are displayed.

Use H

Changes the hue of any underlying colours as you paint, effectively 'tinting' an area with a new colour.

Use H&S

This changes the hue as well as the saturation of underlying colours, much like laying translucent film over the background.

And / Or / Xor

Carries out binary calculations on pixels in the brush and pixels in the background to create new colours.

Source

These are the options to define where to get the pixels for the drawing operations.

Color is the default value, and allows drawing using the custom brush or palette colours.

Pattern allows you to set a fill pattern from a custom brush and affects BOTH foreground and background modes.

Panto allows you to introduce a second crosshair for a computerised pantograph effect, using the Set function to define the offset.



“BLACK CRYPT” – IF YOU LIKE YOUR DUNGEONS DRIPPING WITH MONSTERS.

The “Black Crypt”™ positively oozes with twenty five of the most hideous and despicably cunning monsters.

They await you in a dozen plague-ridden inter-connecting dungeons, on 20 spell binding levels.

The most heinous among them is the Dark Lord Estoroth, who, many centuries ago, had been banished from the land by four Guardians with awesome supernatural powers. In the process, the Guardians and their weaponry had been lost.

Now Estoroth is back, seeking a ghastly

revenge against a defenceless people.

Your task is to lead an intrepid band of adventurers to retrieve the mystical artifacts that may hold the power of the four Guardians and provide your only chance of saving the world from evil.

The “Black Crypt” is the most electrifying fully animated dungeon adventure, with exceptionally detailed rotating point-of-view perspective.

It features real-time combat and spell-casting, all in 64 colour extra half-brite Amiga graphics.

But be warned, you enter this breeding ground of evil at your own peril. And hopefully not on a full stomach.

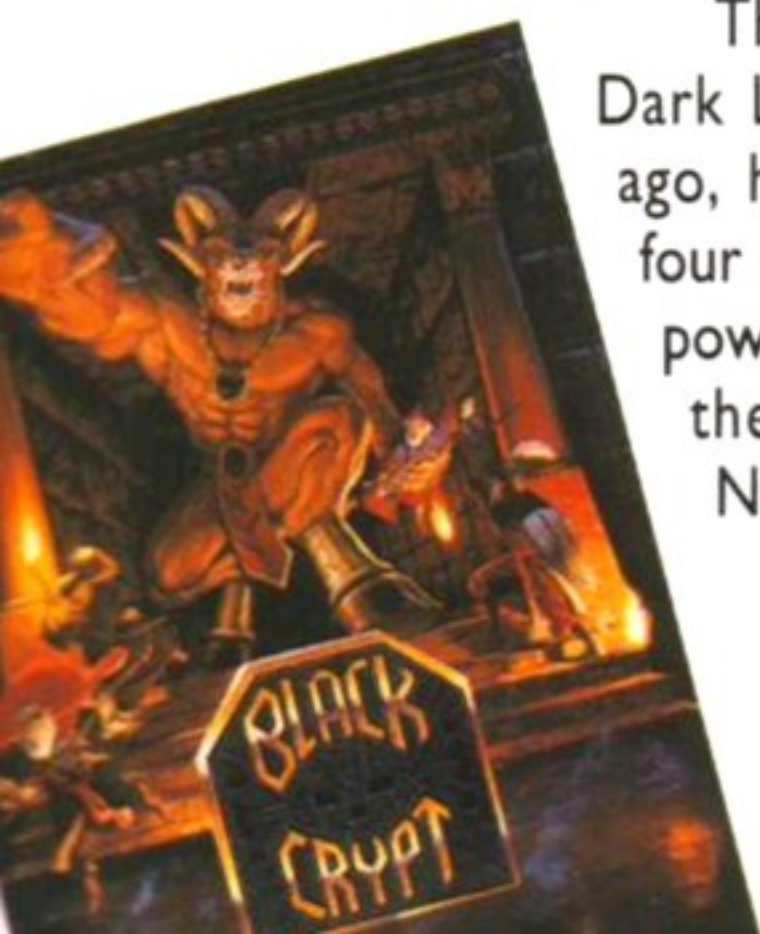

£25.99

Available on Amiga.

ELECTRONIC ARTS™

Electronic Arts, Langley Business Centre, 11-49 Station Road, Langley, Berks SL3 8YN,
Tel: 0753 549442, Fax: 0753 546672



Amiga Software --- Games marked (NOP) will not work on the AMIGA A500 PLUS.

2 HOT 2 HANDLE (OFF ROAD RACER, TOTAL RECAL, SHADOW WARRIOR)..... 19.49	DYNASTY WARS (NOP)..... 2.99	KLAX..... 7.99	RED ZONE..... 16.99
3D CONSTRUCTION KIT..... 33.99	E-MOTION..... 4.99	KNIGHTMARE..... 19.49	RISE OF THE DRAGON (1 MEG)..... 25.99
4 WHEEL DRIVE..... 16.99	ELF..... 16.49	KNIGHTS OF THE SKY (1 MEG)..... 22.99	ROBIN HOOD..... 16.99
(LOTUS ESPRIT TURBO, TEAM SUZUKI, TOYOTA CELICA, COMBO RACER)..... 19.49	ELITE..... 9.99	LEANDER..... 16.99	ROBOCOP 3..... 16.99
4D SPORTS BOXING..... 16.99	ELVIRA 2 JAWS OF CERBERUS (1 MEG)..... 22.99	LEATHER GODDESSES..... 8.99	RODLAND..... 16.99
4D SPORTS DRIVING..... 16.99	EPIC (COMING SOON)..... 16.99	LEGEND..... 19.99	ROGER RABBIT IN HARE RAISING HAVOC (HARD DRIVE REQUIRED) (DISNEY)..... 16.99
A10 TANK KILLER (1 MEG)..... 22.99	EXILE..... 16.49	LEISURE SUIT LARRY 2 (SIERRA)..... 12.99	ROLLING RONNY..... 16.49
A320 AIR-BUS..... 21.49	EYE OF THE BEHOLDER (SSI) (1 MEG)..... 19.99	LEISURE SUIT LARRY 5 (1 MEG)..... 25.99	RORKE'S DRIFT..... 15.99
ACTION MASTERS (F16 COMBAT PILOT, ITALY 1996, DOUBLE DRAGON 2, TURBO OUTRUN, WELLTRIS) (NOP)..... 18.99	EYE OF THE BEHOLDER 2..... 19.99	LEMMINGS..... 13.99	RUGBY WORLD CUP..... 12.99
ADVANTAGE TENNIS..... 16.99	F15 STRIKE EAGLE 2 (1 MEG)..... 11.99	LEMMINGS DATA DISK - OH NO!..... 13.99	SAMURAI: THE WAY OF THE WARRIOR..... 19.49
AFTERBURNER..... 7.99	F16 FALCON (NOP)..... 12.99	LIFE AND DEATH..... 16.99	SCRABBLE DE LUXE..... 9.99
AGONY..... 16.99	F18 INTERCEPTOR..... 8.99	LOMBARD RAC RALLY..... 7.99	SECRET OF MONKEY ISLAND (1 MEG)..... 19.99
AIR SEA SUPREMACY (GUNSHIP, SILENT SERVICE, P47, WINGS, CARRIER COMMAND)..... 19.99	F19 STEALTH FIGHTER..... 14.99	LORD OF THE RINGS..... 19.49	SECRET OF MONKEY ISLAND 2..... 19.99
AIR SUPPORT..... 16.99	F29 RETALIATOR..... 16.99	LOTUS TURBO CHALLENGE..... 8.99	SECRET OF THE SILVER BLADE (1 MEG)..... 19.99
AIR, LAND & SEA (688 ATTACK SUB, INDY 500, F18 INTERCEPTOR)..... 22.49	FACE OFF (NOP)..... 16.49	MAGIC POCKETS..... 16.99	SHADOW OF THE BEAST 2 WITH SHIRT..... 12.99
ALCATRAZ..... 15.99	FERRARI FORMULA 1..... 8.99	MAGNETIC SCROLLS VOL.1 (GUILD OF THIEVES, FISH, CORRUPTION)..... 19.99	SHADOW OF THE BEAST..... 6.99
ALIEN BREED (1 MEG)..... 16.49	FINAL BLOW (NOP)..... 16.99	MANCHESTER UNITED EUROPE..... 8.99	SHOWLANDS..... 19.49
ALIEN STORM..... 16.99	FINAL FIGHT (NOP)..... 16.99	MANIC MINER..... 9.99	SILENT SERVICE 2 (1 MEG) (NOP)..... 22.99
AMNIOS..... 9.99	FIRST SAMURAI - MEGA LO MANIA..... 19.99	MEGA LO MANIA - FIRST SAMURAI..... 19.99	SIM ANT..... 22.99
AMOS (GAMES CREATOR)..... 32.99	FISTS OF FURY (DYNAMITE DUX, NINJA WARRIORS, SHINOBI, DOUBLE DRAGON 2) (NOP)..... 9.99	MEGA TWINS..... 16.99	SIM CITY & POPULOUS..... 16.99
AMOS 3D (REQUIRES AMOS)..... 22.99	FIVE NATIONS RUGBY..... 16.99	MEGATRAVELLER 1 (1 MEG)..... 19.99	SIM CITY ANCIENT CITIES..... 11.99
AMOS COMPILER (REQUIRES AMOS)..... 19.99	FLAMES OF FREEDOM (MIDWINTER 2)..... 11.99	MERCENARY 3..... 16.99	SIM CITY FUTURE WORLDS..... 11.99
AMOS EASY (FIRST STEPS TO PROGRAMMING)..... 22.99	FLIGHT SIMULATOR 2..... 22.99	MERCHANT COLONY..... 18.99	SIM CITY TERRAIN EDITOR..... 11.99
ANOTHER WORLD..... 16.99	FLOOR 13..... 19.99	MICKEY'S CROSSWORD..... 3.99	SIMULCRA..... 16.99
ARKANOID 2..... 7.99	FORMULA 1 GRAND PRIX..... 22.99	PUZZLE MAKER (5-8 YRS) (DISNEY)..... 17.99	SKYFOX (NOP)..... 3.99
ARMALYTE..... 7.99	FULL CONTACT..... 9.49	MICROPROSE 3D GOLF..... 22.99	SMASH TV..... 16.99
ARMOUR-GEDDON..... 9.99	FUN SCHOOL 2 (2-6, 6-8 or 8+)..... 14.99	MIDWINTER..... 13.99	SPACE CRUSADE..... 16.99
AWESOME WITH SHIRT..... 15.99	FUN SCHOOL 3 (2-5, 5-7 or 7+)..... 16.99	MIGHT & MAGIC 2..... 6.99	SPACE QUEST 4 (1 MEG) (SIERRA)..... 25.99
BARBARIAN 2 (PSYGNOSIS)..... 16.99	FUN SCHOOL 4 (2-5, 5-7 or 7+)..... 16.99	MONOPOLY..... 16.99	SPECIAL FORCES..... 22.99
BAR'S TRILOGY..... 22.49	GATEWAY TO THE SAVAGE FRONTIER..... 19.99	MONSTER PACK 2 (KILLING GAME SHOW, AWESOME, BEAST 2)..... 9.99	SPINDIZZY 2..... 7.99
BATTLE COMMAND..... 16.99	GAUNTLET 2..... 7.99	MONTY PYTHON'S FLYING CIRCUS..... 8.99	SPIRIT OF EXCALIBUR..... 10.99
BATTLE ISLE (NOP)..... 19.99	GAUNTLET 3..... 16.99	MOONSHINE RACERS..... 12.99	STEVE DAVIS SNOOKER..... 5.99
BATTLE OF BRITAIN..... 19.99	GODS..... 16.99	MOONSTONE..... 19.49	STORM MASTER..... 19.49
BATTLECHESS 2..... 17.99	GOLDEN AXE..... 8.49	MYSTICAL..... 3.99	SUPER CARS (GBH)..... 6.99
BIG RUN..... 16.99	GOLF WORLD CLASS LEADERBOARD..... 7.99	NEBULUS 2..... 16.99	SUPER CARS 2 (NOP)..... 16.99
BIRDS OF PREY (1 MEG)..... 19.49	GRAHAM GOOCH WORLD CRICKET..... 18.49	NITRO..... 6.49	SUPER HANG ON..... 7.99
BLACK CRYPT..... 16.99	GUY SPY..... 19.49	NUCLEAR WAR..... 5.99	SUPER LEAGUE MANAGER..... 16.49
BLUE MAX..... 19.99	HARLEQUIN..... 16.99	OPERATION WOLF..... 7.99	SUPER SPACE INVADERS..... 16.49
BLUES BROTHERS..... 16.99	HARPOON..... 15.99	ORK..... 16.99	SUPREMACY..... 9.99
BONANZA BROS..... 16.99	HEAD OVER HEELS..... 7.99	PACMANIA..... 9.99	SWIV (NOP)..... 9.99
BREACH 2 (ENHANCED)..... 18.49	HEART OF CHINA (1 MEG)..... 22.99	PAPERBOY 2..... 16.99	SWORD OF SODAN..... 7.99
BUDOKAN..... 8.99	HEIMDALL (1 MEG)..... 17.99	PARASOL STARS..... 16.99	T.N.T. (HYDRA, SKULL & CROSSBONE, BADLANDS, STUN RUNNER, HARD DRIVIN 2)..... 16.49
CADAVER..... 9.99	HEROQUEST (GREMLIN)..... 16.99	PAW PAL (M/SCROLLS)..... 7.99	TEAM YANKEE..... 19.99
CADAVER LEVELS - THE PAY OFF..... 11.99	HILL STREET BLUES..... 15.99	PEN PAL WORD PROCESSOR..... 64.99	TERMINATOR 2..... 16.99
CAPTAIN PLANET..... 16.99	HITCH HIKERS GUIDE..... 8.99	PGA TOUR GOLF..... 19.49	TETRIS..... 13.99
CAPTIVE..... 6.99	HOLLYWOOD COLLECTION (ROBOCOP, GHOSTBUSTERS 2, INDIANA JONES ACTION, BATMAN THE MOVIE) (NOP)..... 9.99	PGA TOUR GOLF COURSE DISK..... 11.49	THE GAMES - SUMMER EDITION..... 7.99
CASTLES (1 MEG)..... 19.49	HOME ACCOUNTS 2..... 39.99	PINBALL DREAMS (1 MEG)..... 16.99	THE GODFATHER (1 MEG)..... 19.99
CELTIC LEGENDS..... 19.99	HOME ALONE..... 16.99	PIRATES (NOP)..... 16.49	THE MANAGER..... 16.99
CENTURION DEFENDER OF ROME..... 16.99	HOOK..... 16.99	PLAN 9 FROM OUTER SPACE..... 19.49	THE SIMPSONS..... 16.99
CHAMPIONS (MANCHESTER UTD, BOXING MANAGER, J.KHANN SQUASH)..... 12.99	HUNTER..... 19.49	PLAYER MANAGER..... 8.99	THUNDERHAWK..... 9.99
CHAMPIONS OF KRYNN (1 MEG)..... 19.99	HYBRIS..... 5.99	POOLS OF DARKNESS (1 MEG)..... 19.99	TIP OFF..... 16.49
CHAMPIONSHIP MANAGER..... 19.49	IAN BOTHAMS CRICKET..... 19.49	POPULOUS 2 (1 MEG)..... 19.49	TITUS THE FOX..... 16.99
CHART ATTACK (LOTUS ESPRIT, GHOULS-GHOSTS, JAMES POND, VENUS THE FLY TRAP) (NOP)..... 19.49	JK..... 7.99	POWER UP (CHASE H.Q., TURRICAN, X-OUT, ALTERED BEAST, RAINBOW ISLANDS) (NOP)..... 9.99	TOYOTA CELICA GT RALLY..... 7.99
CHRONOQUEST 2..... 7.99	INDIANA JONES ADVENTURE..... 9.99	POWERDRIFT (NOP)..... 3.99	TRIAD VOL 2 (MENACE, BAAL, TETRIS) (NOP)..... 8.99
CHUCK ROCK..... 16.49	INDIANAPOLIS 500..... 16.99	POWERMONGER..... 19.49	TURBO CUP (NOP)..... 3.99
CHUCKIE EGG..... 9.99	INDY HEAT..... 16.99	POWERMONGER WORLD WAR 1 DATA DISK..... 11.99	TURTLES 2..... 19.49
CHUCKIE EGG 2..... 9.99	INTERCEPTOR RENEGADE LEGION (SSI)..... 6.99	POWERWORKS (MAXIPLAN PLUS SPREADSHEET, KIND WORDS 2 WORD PROCESSOR, INFOFILE DATABASE)..... 44.99	TV SPORTS BASEBALL..... 19.99
CORPORATION PLUS MISSION DISK..... 11.99	INTERNATIONAL CHAMP ATHLETICS..... 15.99	PRINCE OF PERSIA (1 MEG)..... 7.99	ULTIMA 5..... 10.99
CORRUPTION (M/SCROLLS)..... 3.99	INTERNATIONAL SPORTS CHALLENGE..... 19.49	PRO TENNIS TOUR 2..... 16.99	ULTIMA 6 (1 MEG)..... 20.99
COVERT ACTION..... 22.99	INTERPHASE..... 2.99	PROJECT X (1 MEG)..... 16.99	UNIVERSAL MILITARY SIMULATOR 2 (1 MEG)..... 22.99
CRUISE FOR A CORPSE..... 19.99	IT CAME FROM THE DESERT (1 MEG)..... 10.99	PROTECT VERSION 4.3..... 39.99	UTOPIA..... 19.49
CURSE OF THE AZURE..... 19.99	JACK NICKLAUS GOLF..... 6.99	QUEST & GLORY (BLOODWYCH, MIDWINTER, CADAVER, BAT)..... 20.49	UTOPIA NEW WORLDS DATA DISK..... 11.49
BOND (1 MEG) (SSI)..... 19.99	JAGUAR XJ220 (1 MEG)..... 17.99	QUEST & GLORY (BLOODWYCH, MIDWINTER, CADAVER, BAT)..... 20.49	VENGEANCE OF EXCALIBUR..... 19.49
DAILY SPORTS COVER GIRL POKER..... 16.99	JAMES POND..... 7.49	RACE DRIVIN..... 16.49	VENUS THE FLY TRAP..... 7.49
DEATH KNIGHTS OF KRYNN (1 MEG)..... 19.99	JAMES POND 2 - ROBOCOD..... 16.99	RAILROAD TYCOON (1 MEG)..... 22.99	VROOM..... 16.99
DELUXE PAINT 3 (WITH ANIMATION)..... 34.99	JET SET WILLY..... 9.99	RAINBOW COLLECTION (BUBBLE BOBBLE, RAINBOW ISLANDS, NEW ZEALAND STORY)..... 9.99	WAR ZONE..... 9.99
DELUXE PAINT 4 (1 MEG) (HAM MODE & ANIMATION)..... 58.99	JIMMY WHITES SNOOKER..... 14.99	RBI BASEBALL 2 (NOP)..... 19.49	WHEELS OF FIRE (HARD DRIVIN, POWERDRIFT, CHASE H.Q., TURBO OUTRUN) (NOP)..... 8.99
DEUTEROS (NOP)..... 16.99	JINXTER (M/SCROLLS)..... 3.99	REALMS..... 9.99	WILD WEST WORLD..... 16.99
DICK TRACY ADVENTURE..... 19.49	JOHN MADDENS (U.S.) FOOTBALL..... 16.99	RED BARON (1 MEG)..... 22.99	WILLY BEAMISH..... 22.99
DISNEY ANIMATION STUDIO..... 49.99	KICK OFF + EXTRA TIME DISK..... 4.49		WINGS (1 MEG)..... 14.99
DOUBLE DOUBLE BILL (NOP)..... 22.99	KICK OFF 2 (1 MEG)..... 8.99		WOLFCHILD..... 12.99
DOUBLE DRAGON 3..... 16.99	KICK OFF 2 FINAL WHISTLE..... 9.49		WONDERLAND (1 MEG)..... 13.99
DRAGON WARS..... 13.99	KICK OFF 2 GIANTS OF EUROPE..... 7.99		WORDSWORTH WORD PROCESSOR (1 MEG)..... 79.99
DYNA BLASTERS..... 20.49	KICK OFF 2 RETURN TO EUROPE..... 7.99		WORLD CLASS RUGBY (AUDIOGENIC)..... 16.49
	KICK OFF 2 WINNING TACTICS..... 6.99		WWF WRESTLING..... 16.99
	KICK OFF 3..... 16.99		
	KID GLOVES 2..... 16.99		
	KIDSTYPE JUNIOR WORD PROCESSOR..... 15.99		
	KINGS QUEST 5 (1 MEG) (SIERRA)..... 25.99		

COMPETITION PRO 5000 (COLOURS MAY VARY) 8.99

Over 100,000 people have joined Special Reserve
The club with no obligation to buy
Tel. 0279 600204 for a free COLOUR catalogue

Special Reserve

Games Club



AMIGA A500 PLUS LEMMINGS PACK WITH LEMMINGS, THE SIMPSONS, CAPTAIN PLANET, 1 MEG RAM (BUILT-IN), MOUSE, TV MODULATOR, WORKBENCH 2.0.

FREE SPECIAL RESERVE MEMBERSHIP, FREE COMPETITION PRO 5000 JOYSTICK

349.99



AMIGA A500 PLUS CARTOON PACK WITH LEMMINGS, THE SIMPSONS, CAPTAIN PLANET, DELUXE PAINT 3, 1 MEG RAM (BUILT-IN), MOUSE, TV MODULATOR, WORKBENCH 2.0

FREE SPECIAL RESERVE MEMBERSHIP

369.99

NEWAMIGA 600 KICK OFF 2 PACK

WITH DELUXE PAINT 3, GAME DISK, BUILT-IN TV MODULATOR, 1 MEG RAM EXPANDABLE TO 2 MEG, IN-HOME SERVICE.

FREE KICK OFF 2, FREE COMPETITION PRO JOYSTICK FREE SPECIAL RESERVE MEMBERSHIP

399.99

NEWAMIGA 600 HD ROGER RABBIT

AS AMIGA 600 WITH INTERNAL 20 MEG HARD DRIVE. FREE ROGER RABBIT DISNEY GAME, FREE COMPETITION PRO JOYSTICK FREE SPECIAL RESERVE MEMBERSHIP

499.99



COMMODORE CDTV MACHINE WITH INFRA-RED CONTROL PAD, WELCOME DISK, HUTCHINSONS ENCYCLOPEDIA AND LEMMINGS

FREE SPECIAL RESERVE MEMBERSHIP

469.99



PHILIPS CM8833 MARK 2 COLOUR STEREO MONITOR FOR AMIGA OR ATARI ST FREE MONITOR LEAD FREE MEMBERSHIP

229.99

TV TUNER FOR PHILIPS CM8833 MKII MONITOR ONLY (TURNS THE MONITOR INTO A TV).....44.99

MONITOR LEAD AMIGA TO PHILIPS CM8833 II9.99



CANON BJ-10EX BUBBLE JET PRINTER 64 NOZZLE, 80 COLUMN, 83LQ CPS 2LQ/1 DRAFT FONT, 12 MONTH WARRANTY. A SMALL, PORTABLE PRINTER, VERY QUIET IN OPERATION YET GIVING OUTSTANDING PRINT QUALITY. FREE PRINTER LEAD FREE MEMBERSHIP

249.99

INK CARTRIDGE FOR BJ10EX.....20.99



CITIZEN SWIFT 9 PRINTER WITH COLOUR KIT 9 PIN, 80 COLUMN, 192CPS/48NLQ, 3LQ/1 DRAFT FONT, 24 MTH WARRANTY. A 9 PIN PRINTER WITH COLOUR FACILITY AND FULL PAPER HANDLING FUNCTIONS. FREE PRINTER LEAD FREE MEMBERSHIP FREE COLOUR KIT

199.99

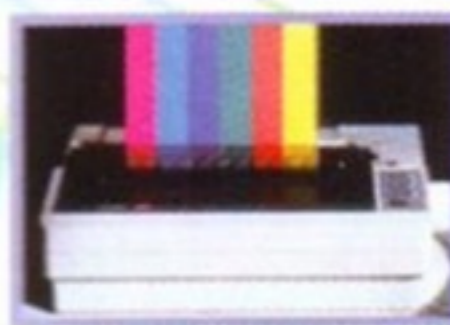

CITIZEN 224 PRINTER WITH COLOUR KIT. 24 PIN, 80 COLUMN, 192CPS/64LQ, 3LQ/1 DRAFT FONT, 24 MTH WARRANTY. 24 PIN LETTER QUALITY PRINTER WITH EXCELLENT GRAPHICS CAPABILITY (360X360 DPI). FREE PRINTER LEAD FREE MEMBERSHIP FREE COLOUR KIT

249.99



CITIZEN SWIFT 24E PRINTER WITH COLOUR KIT. 24 PIN, 80 COLUMN, 216CPS/72LQ, 6LQ/1 DRAFT FONT, 24 MTH WARRANTY. ADVANCED ON 224, HIGHER SPEED, MORE FONTS, LCD CONTROL PANEL FREE PRINTER LEAD FREE MEMBERSHIP FREE COLOUR KIT

279.99



CITIZEN 120D+ PRINTER 9 PIN, 80 COLUMN, 144 CPS/25NLQ, 2NLQ/1 DRAFT FONT, 24 MTH WARRANTY. HIGH QUALITY BLACK AND WHITE PRINTER. FREE PRINTER LEAD FREE MEMBERSHIP

134.99

PRINTER LEAD (PARALLEL)9.99
RIBBON FOR SWIFT 9 OR 120D+6.99
RIBBON FOR SWIFT 24 OR 2246.99
RIBBON (COLOUR) SWIFT 9, 24 OR 22415.99

GVP HD8+ 52 MEGABYTE AMIGA HARD DRIVE (SERIES II) WITH EXPANSION SLOTS TO UPGRADE AMIGA RAM TO 8 MEG 369.99



GVP HD8+ 120 MEGABYTE AMIGA HARD DRIVE (SERIES II) WITH EXPANSION SLOTS TO UPGRADE AMIGA RAM TO 8 MEG 529.99

GVP 2x1 MEG AMIGA RAM EXPANSION (SIMMS FIT IN GVP HARD DRIVE TO EXPAND AMIGA BY 2 MEG OR 4 MEG RAM)89.99

GVP 2x4 MEG AMIGA RAM EXPANSION (SIMMS FIT IN GVP HARD DRIVE TO EXPAND AMIGA TO 8 MEG RAM)379.99

COMMODORE A590 20 MEG HARD DRIVE FOR AMIGA (AUTOBOOT WITH KICKSTART, SOCKETS FOR 2 MEG OF RAM, SCSI INTERFACE FOR PERIPHERALS CONNECTION)284.99

512K AMIGA RAM WITH CLOCK (MICRO MEMORY)28.99
512K AMIGA RAM WITHOUT CLOCK (TECNOPLUS)24.99

A501 (WITH BART) AMIGA 512K RAM EXPANSION GENUINE ITEM WITH CLOCK FREE BART SIMPSON GAME 49.99



EXTERNAL 3.5" DISK DRIVE FOR AMIGA. SONY/CITIZEN DRIVE MECHANISM. QUIET, HIGH QUALITY, SLIM. 54.99

NAKSHA AMIGA/ST MOUSE WITH OPERATION STEALTH 24.99



SQUIK MOUSE FOR AMIGA/ST 15.99

SPECIAL RESERVE MOUSE MAT 4.99



CLEANING KIT FOR COMPUTERS (INCLUDES VACUUM) 19.99

TECNOPLUS REPLACEMENT AMIGA POWER SUPPLY (THE 4.5 AMP OUTPUT ALSO ENABLES AMIGAS TO RUN PERIPHERALS EFFICIENTLY) 39.99

TECNOPLUS AMIGA STARTER PACK WITH AMOS, PRINCE OF PERSIA, QUICKSHOT 131 DELUXE DIGITAL JOYSTICK, DUST COVER, MOUSE PAD, FILE-A-DISK RECORD SYSTEM, DISK CLEANER, 5 BLANK DISKS 39.99



AMIGA SOUND ENHANCER (BOOSTS SOUND) 34.99

ROCTEC EXTERNAL STEREO SPEAKERS (WITH BUILT IN AMPLIFIERS) FOR AMIGA, CDTV, ATARI ST AND PC34.99
DUST COVER FOR AMIGA OR ATARI ST (CLEAR PVC)4.99
DUST COVER FOR MONITOR (CLEAR PVC)5.99
DUST COVER FOR 80 COLUMN PRINTER (CLEAR PVC)5.99

AMIGA TO SCART LEAD (GIVES MONITOR QUALITY ON TV WITH SCART/RGB INPUT)9.99
HI-FI CONNECTION CABLE FOR AMIGA (CONNECT AMIGA TO STANDARD PHONO INPUT)3.99
RF LEAD FOR AMIGA/ST (STANDARD LEAD TO TELEVISION)3.99
TV RF INPUT SWITCH FOR AMIGA/ST (SWITCH BETWEEN TV AERIAL AND COMPUTER WITHOUT DISCONNECTING)3.99
POPULOUS/FALCON LEAD (NULL MODEM CABLE)7.99
FOUR PLAYER AMIGA/ATARI ST JOYSTICK ADAPTOR (FOR KICK OFF 2 ETC)8.99
JOYSTICK EXTENDER CABLE FOR AMIGA/ST (ALLOWS JOYSTICK TO BE UP TO 3 METRES FROM COMPUTER)6.99
ROBOSHIFT INTERFACE FOR AMIGA/ST (PLUGS MOUSE & JOYSTICK INTO ONE PORT)14.99
PORT EXTENSION ADAPTOR FOR AMIGA/ST (CHANGE JOYSTICKS WITHOUT NEEDING TO REACH BEHIND COMPUTER)5.99

3.5" DSDD GOLDSTAR DISK WITH LABEL59p each
PACK OF 50 GOLDSTAR 3.5" DSDD DISKS WITH LABELS24.99
3.5" DISK HEAD CLEANER4.99
DISK BOX 3.5" (10 CAPACITY)1.99



DELUXE DISK BOX 3.5" (80), LOCKABLE, DIVIDERS10.99

Goldstar
3.5" DS/DD DISK with LABEL
69p each or
24.99 for 50

Nintendo Super NES

NEW 149.99

+ CONTROLLER AND SUPER MARIO WORLD
FREE SECOND CONTROLLER
FREE STEREO LEAD
FREE NINTENDO MARIO GAME & WATCH
FREE SPECIAL RESERVE MEMBERSHIP
FREE £5.00 REPLAY VOUCHER
SEE ALSO GOLDSTAR TELEVISION/MONITOR



0279 600204
Open to 8pm Weekdays and to 5pm Weekends

ANNUAL MEMBERSHIP
UK £6.99 EEC £8.99 WORLD £10.99
We only supply members but you can order as you join.

The Special Reserve full colour club magazine **NRG** is sent to all members bi-monthly. **NRG** features full reviews of new games plus mini-reviews, all the gen on new products, the Special Reserve charts, Release Schedule of new games and hundreds of special offers. PLUS - EVERY ISSUE CONTAINS



£30 worth of money-off coupons to save even more money off our amazing prices. We sell games and accessories, all at amazing prices, for Megadrive, Master System, Game Gear, Super NES, Gameboy, NES, Lynx, Amiga, Atari ST, IBM PC, CDTV and IBM CD ROM.

Best Service, Best Prices, Biggest Selection
That's why over 100,000 people have joined Special Reserve.



159.99

Goldstar 14" Television/Monitor
WITH REMOTE CONTROL AND SCART INPUT

GIVES PIXEL-CLEAR PICTURE WHEN USED AS A MONITOR VIA THE SCART LEAD PROVIDED. AND IT'S A TELEVISION WITH REMOTE CONTROL. FREE SPECIAL RESERVE MEMBERSHIP FREE AMIGA TO GOLDSTAR SCART LEAD PLEASE CLEARLY STATE AMIGA LEAD REQUIRED

OR SAME PRICE WITH UK MEGADRIVE SCART LEAD OR FOR UK SUPER NES FROM EURO CONNECTOR

Inter-Mediates Ltd. Registered Office: 2 South Block, The Maltings, Sawbridgeworth, Herts CM21 9PG.
INEVITABLY, SOME GAMES MAY NOT YET BE RELEASED. PLEASE PHONE SALES ON 0279 600204 FOR LATEST RELEASE DATES AND STOCK AVAILABILITY.

WE ONLY SUPPLY MEMBERS BUT YOU CAN ORDER AS YOU JOIN. THERE IS A SURCHARGE OF 50p PER GAME ON TELEPHONED ORDERS. (PLEASE PRINT IN BLOCK CAPITALS)

AMFORM 20

Name _____

Address _____

Postcode _____

Telephone _____ Machine type _____

Enter membership number (if applicable) or Membership £6.99 UK, £8.99 EEC, £10.99 World

item _____

item _____

item _____

item _____

ALL PRICES INCLUDE UK POSTAGE & VAT £

Cheque/P.O./Access/Mastercard/Switch/Visa _____ Switch Issue No _____

Credit card expiry date _____ Signature _____

Cheques payable to: **SPECIAL RESERVE P.O. BOX 847, HARLOW, CM21 9PH**
Overseas Orders: EEC software orders - no extra charge
World software orders please add £1.00 per item.
Non-software items please add 10% EEC or 25% World.
Overseas orders must be paid by credit card.

Sensible

SOCCER

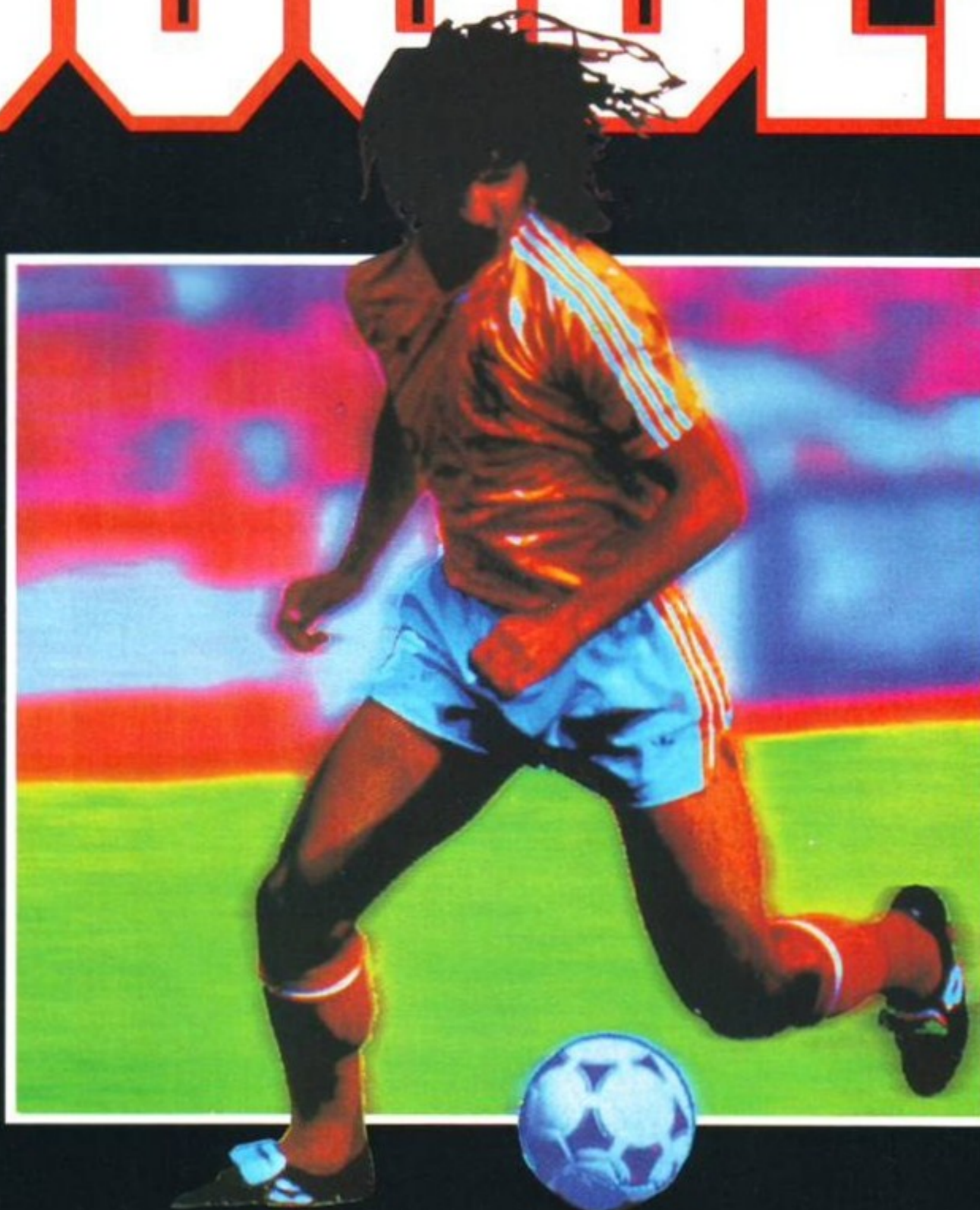

European Champions

- ★ 100 EUROPEAN TEAMS
- ★ DESIGN YOUR OWN CUP TOURNAMENT
- ★ 1 & 2 PLAYER ACTION
- ★ OVERHEAD KICKS, DIVING HEADERS, Etc.
- ★ SLICK, FAST, INTELLIGENT PASSING
- ★ SAVE UP TO 10 REPLAYS AS HIGHLIGHTS



- ★ SECOND DISC FULL OF CROWD SOUNDS
- ★ EUROPEAN CHAMPIONSHIP COMPETITION
- ★ AMAZINGLY DETAILED KITS
- ★ SUBS BENCH WITH MANAGER & PHYSIO
- ★ TACTICAL ADVICE ON OPPOSITE TEAM
- ★ NAMED SCORERS



Sensible
SOFTWARE

C1, Metropolitan Wharf, Wapping Wall, London E1 9SS © 1992 Sensible Software. Published by Renegade



A600 smart cards: an end to piracy?

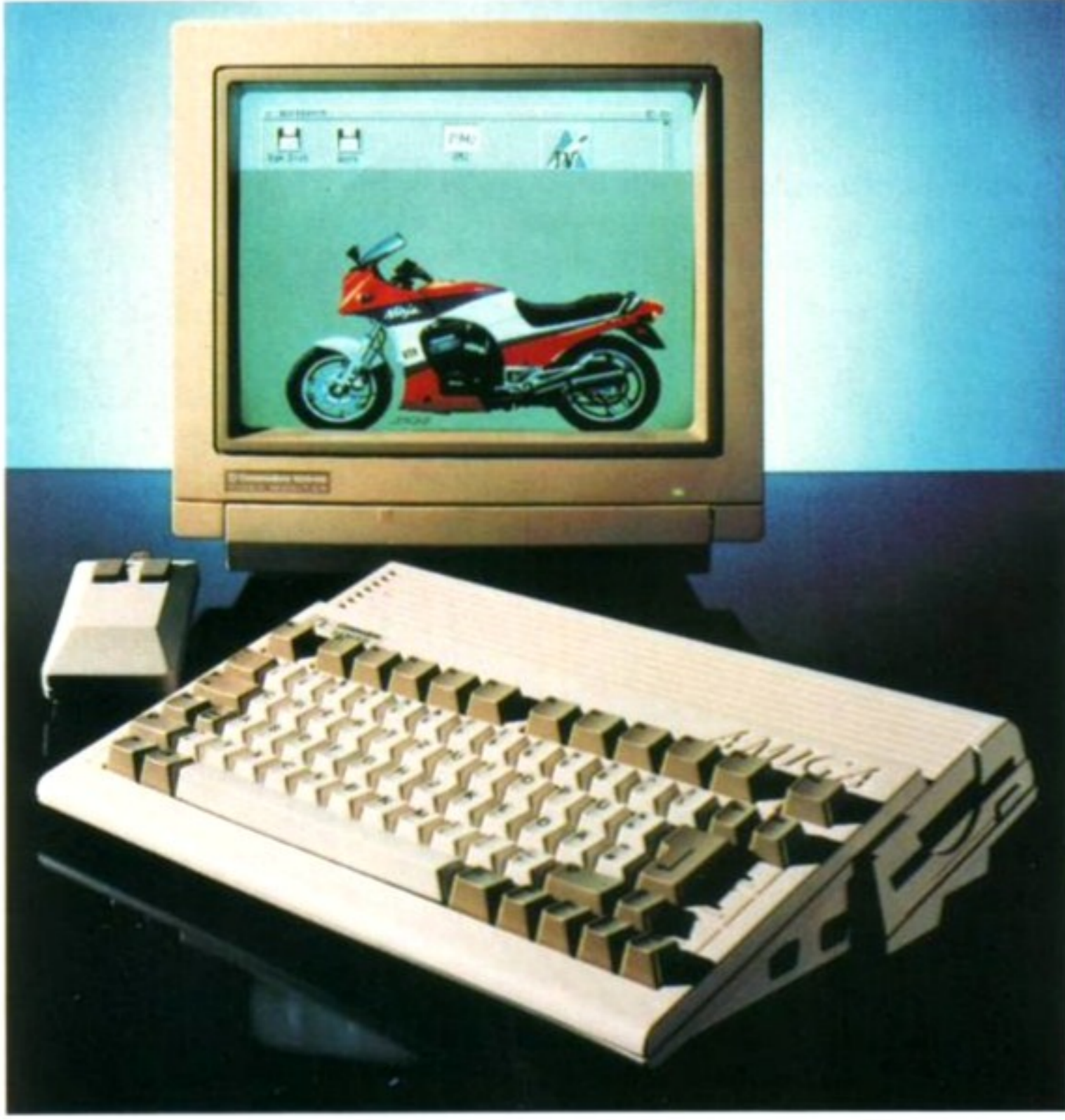

Another Amiga is about to be sprung on the public. The big software houses are complaining of lack of consultation and few are committing themselves to smart card development.

THE MOST INNOVATIVE feature of the new Amiga 600 is its cartridge capability. A ROM slot has been built into Commodore's latest creation with the hope that third-party companies will develop smart card software. The implications of this are an end to piracy and the possibility of huge games with no loading time. However, if the software industry doesn't support ROM cards, the A600 will become little more than a slightly shorter Amiga with a snappy case.

In time-honoured fashion, Commodore have largely chosen to just spring the A600 on the software industry. The American arm of the company were speaking directly to several companies (Renegade produced a smart card demo for

Commodore Germany), but even the largest of software houses are unsure if they will be producing special games.

Although US Gold don't produce many games themselves, they told **Amiga Format** that their affiliates (particularly the Americans) are very interested in smart card software. Access, Cineplay, Lucasfilm and SSI are all keen to get some software out on ROM. These companies' games will lend themselves particularly well to being placed on smart card because they are large, colourful games which use every byte of the Amiga's memory. US Gold's official line is that they're looking into the possibilities, but are waiting to see how well the machine takes off.

This 'wait-and-see' attitude is being echoed at Domark, "We'll see how it sells", Storm "Seems like a good idea, but we've got nothing planned", Ocean "We'll see how much penetration the machine gets before committing ourselves" and Virgin "We will produce software for it, but we haven't got anything planned at the moment". There are however, some encouraging noises coming from software developers like Bullfrog; Peter Molyneux is very keen on creating smart card software, but is very nonplussed by Commodore's attitude. He said, "We've been supporting the Amiga from the very beginning, so I find it frustrating when they don't let the developer know beforehand that a new machine is being launched". Peter is keen on getting games like *Populous 2* onto ROM because they are so hard pushed to fit extremely large games onto the Amiga.

Electronic Art's Simon Jeffreys echoes Peter Molyneux's sentiments. He feels that the machine has taken a lot of people by surprise. He revealed that EA are looking into the possibility of smart card software, but he believes the responsibility for its success or failure lays squarely at the software companies' doors. He said, "If it gets the backing of the (software) publishers then it will be a whole new era for the computer industry".

Similarly, the CodeMasters are interested in the possibilities. Richard Eddy is confident that their software will start coming out on smart card because, he said, "We are used to cartridge technology already". Richard feels it is the gamers who will be the ones to benefit from ROM-based games, because software could be so much more sophisticated.

It's not all fence sitting though. Richard Barclay at Core (developers of such brilliant games as *Heimdall* and *Thunderhawk*) said they definitely aren't looking into it. He attacks the 'wait-and-see' attitude of the software industry and says they have no plans to create smart card games.

Largely then, the entire Amiga software industry is waiting for someone else to make the first move. Their ambivalence isn't been helped by Commodore's dubious launch methods. If Commodore had tried placing a few machines with developers beforehand, the company could have had games all ready to show off, as it is, the ROM card slot on the A600 is likely to be used for little more than storing coinage.

Philips monitor warning



Philips monitors: not dangerous!

The last issue of **Amiga Format** carried an advertisement with a warning that 'grey imported' cheap Philips monitors could be dangerous. We asked Philips UK to set the record straight, and this is what they have told us.

"We'd like to make clear to your readers that, while the monitors are not designed for the British market, they do not pose a risk for users so long as the user ensures that a British power lead, correctly earthed, is used with the monitor.

"Purchasers of the grey-imported monitors, identifiable by the product codes 10G or 20G, may find that they lack a British power

lead and will have to ensure that they earth the monitor properly when changing the lead before use. They will also certainly miss out on Philips' one-year on-site warranty support and, of course, not receive the free *F-19* flight simulator which is included with every UK version of the CM8833 monitor.

"All genuine UK monitors have the product codes 05G, 55G or 65G and fully comply with either the British Safety Standards BS415 or BS7002, as well as being approved by the BEAB."

In other words, if you have a cheap grey import monitor it's not going to blow up on you, but you must be very careful about fitting a UK plug with the earth lead connected up and you cannot expect to get any user support from Philips. Clear?

CAD makes a comeback



After an absence computer aided design returns to the Amiga in the form of *XCad 2000* and *3000*.

New versions of the CAD (Computer Aided Design) modelling program *XCad* have been given a boost with a new distribution deal in the UK.

DMI (Digital Multimedia Inc), based in Middlesex, will be supplying the new versions of *XCad 2000* and *XCad 3000* from this month, as well as picking up distribution rights to Impulse's *Imagine 2* ray-tracing software, reviewed this month on Page 138.

CAD has been something of a neglected area on the Amiga for a couple of years, but it does actually offer an excellent alternative to structured drawing or 3D modelling for many kinds of illustration work, as well as providing anyone working for a living in landscape, architectural or industrial design a very good Amiga alternative.

The *XCad* program may find a niche as a good alternative to the PC-based industry standard program *AutoCAD* in professional use, as it saves *AutoCAD* format and is claimed to operate screen-drawing operations six times faster on a normal 1Mb Amiga than the PC program does on a fast 386 PC. Prices start from as little as £129 for the entry-level version of the software, *XCad 2000*.

DMI 0702 206165.

Animators, fame awaits!



If you're producing top-class animations like this for the Amiga, there's two chances for you to gain international recognition.



Eric Schwartz is just one of the many top names in animation who has already succeeded in the *Amiga World* competition.

International recognition is just around the corner for accomplished Amiga animators, with two more animation competitions currently looking for entries from around the world.

The UK's best-known animation competition has always been the one held by graphics-orientated Amiga distributors Amiga Centre Scotland to coincide with Edinburgh's international arts festival. However, we've recently been carrying news of a big competition taking place in Italy this month (too late for entries!) and there's now news of two more, in America and Sweden.

The American competition is a well-established event sponsored by the American magazine *Amiga World*. Winning entries are compiled into a videotape by the magazine, so you'll have to be happy to allow them to publish your work, but on the other hand there are prizes worth a total of \$20,000 up for grabs. The closing date for entries is October, so you've got plenty of time to get full details from *Amiga World* at 80 Elm Street, Peterborough, New Hampshire 03458, USA.

The Swedish alternative is on a far more limited scale, with entries constrained to running on a 1Mb Amiga 500 from a single floppy disk. Again winning entries will be published on a videotape, so one-off publishing rights must be granted. The competition has a US \$1,000 first prize and is organised by a group of enthusiasts called the TM Design anim.club, which you can join for a fee of US \$30 per year.

Full details from TM Design anim.club, Emausgatan 29 A, S-722 24 Västerås, Sweden.

CDTV Psycho follows up in special effects orgy



Psycho killers are still very vogue and On-line are hoping to make a killing with the sophisticated sequel.

Psycho Killer from committed CDTV developers On-line was one of the very first CDTV titles to become available, and it's already to get a sequel which has much promise.

Amiga Format was highly critical of the original game: although it was a brave attempt to combine gameplay with a movie-like approach that CDTV should suit so well, we felt that it was a little bit too much like a home video for comfort, with its many screens of digitised graphics shot on location in the home counties. However, it was very popular with buyers all the same.

Psycho Killer 2, by contrast, looks set to break innovative new ground. We've already had a sneak preview and it combines a similar commitment to real-world movie-film basis, but with much improved direction and atmosphere. It also takes the Amiga a step further as a full special-effects unit, many frames of animation having been adapted and manipulated to give some extraordinary and atmospheric effects. It could be the CDTV's first real step into Hollywood-style movie-games: keep an eye out for it soon. On-line 081-558 6114.

Education experts explore new ground

If you have ever considered buying educational software, you can scarcely have failed to come across the name *Fun School*, the series of educational programs which dominate educational software in the UK.

Now Europress Software, the manufacturers of *Fun School* and the beginners' programming languages *AMOS* and *Easy AMOS* (this month's Coverdisk), are set to explore a new approach to educational software.

Whereas the *Fun School* series have succeeded by a scattergun approach – aiming a pack of six simple educational games at a particular age group, but with no real cohesion on subject matter – the new disks will be targetted specifically at one subject and one age-group. One feature of *Fun School* remains: the disks will be dominated by a cartoon character to lend friendliness and accessibility to the approach. Introducing ADI the Alien, who is used as a frontman for the programs and to introduce a progress-monitoring system without too much pain on the user's part. Europress Software MD Chris Payne comments "ADI has so much personality that, during testing, young students happily spent long sessions working on the exercises". Sounds promising!

ADI will preside over a range of packages, starting with maths and English programs separately targetted at 11 and 12-year-olds, with the same for 13 and 14-year-olds to follow and French to come later this year. Europress Software 0625 859333.

CDTV full-motion video gets two new boosts

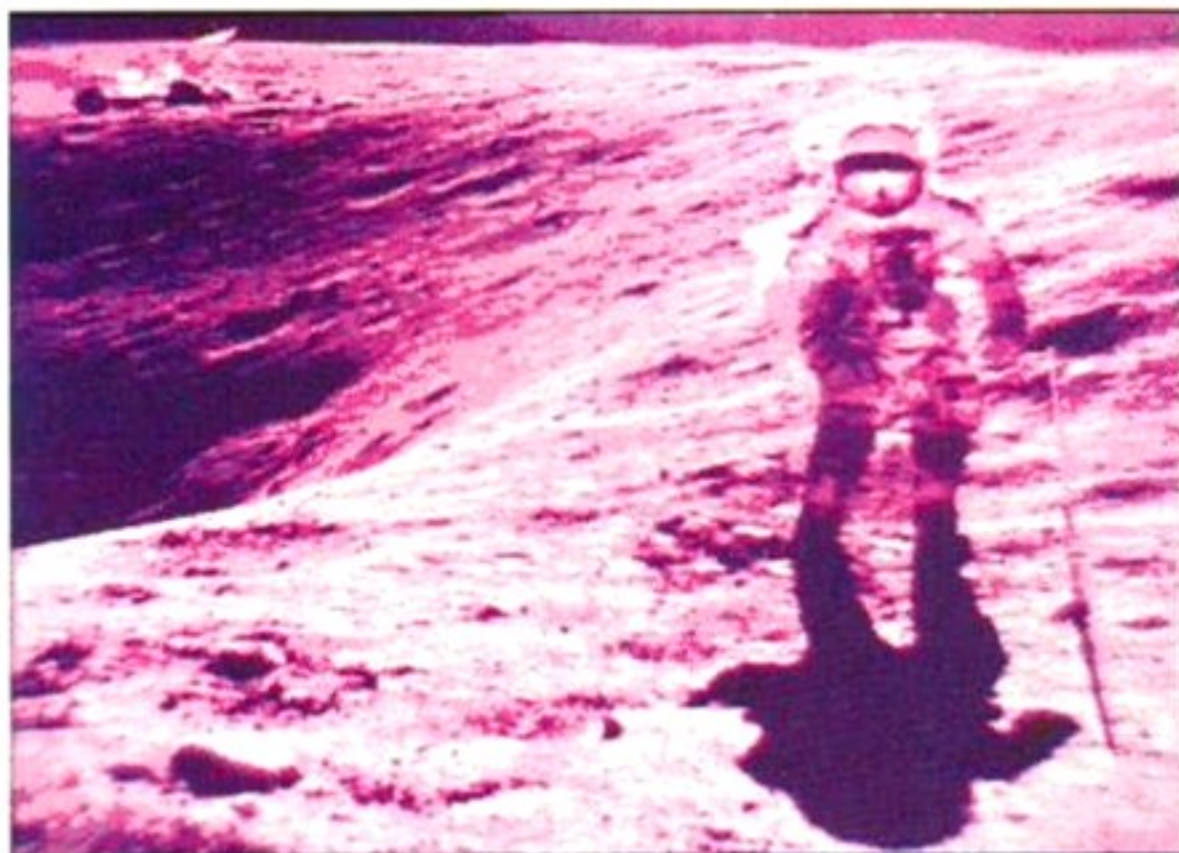

The usability of CDXL, the standard that allows partial-screen 'movies' like the NASA space disc for CDTV, is about to leap forward.

The CDXL standard that brings quarter-screen full-motion video to the CDTV has been given two boosts this month plus there's been an announcement of third-party software support for CDTV developers.

One could be all-important in the do-it-yourself line, as American software manufacturers ASDG have announced that their top image-processing program, the much-vaunted *Art Department Professional*, will be enhanced to give direct support for the CDXL standard.

This will be of particular significance to small developers especially in the USA, where the whole multimedia thing on the Amiga platform has much more in the way of application in business use. CDXL support is provided by an add-on module to the *Art Department*, which allows it to speedily access frames within a video sequence and help convert it into a suitable animation, even to the extent of adding sound. The CDXL add-on will only be available to registered developers.

Meanwhile, any CDTV developer who wishes to incorporate CDXL motion sequences but simply doesn't have the facilities will be glad to hear that Optonica are now providing a service to transfer video tape from any format into CDXL data, even providing a full-screen HAM background to the quarter-screen CDXL window.

Optonica will translate frame by frame from their professional video equipment, and return a CDTV version complete with synched audio if required. They also provide free link code for you to use in your application and a viewer program that allows the sequence to be displayed just as it will appear in the finished version.

All parties that are interested should write including their business card to Lee Gibson who can be reached at Optonica, 1 The Terrace, High Street, Lutterworth, LEICS LE17 6BA. Optonica are the originators of the *Simpatica* Amiga-to-video transfer system and leaders in the multimedia mass-storage development field: contact them for more details.

ASDG (America) 0101 608 273 6585

Optonica 0455 558282.

JEFF FAHEY

PIERCE BROSNAN

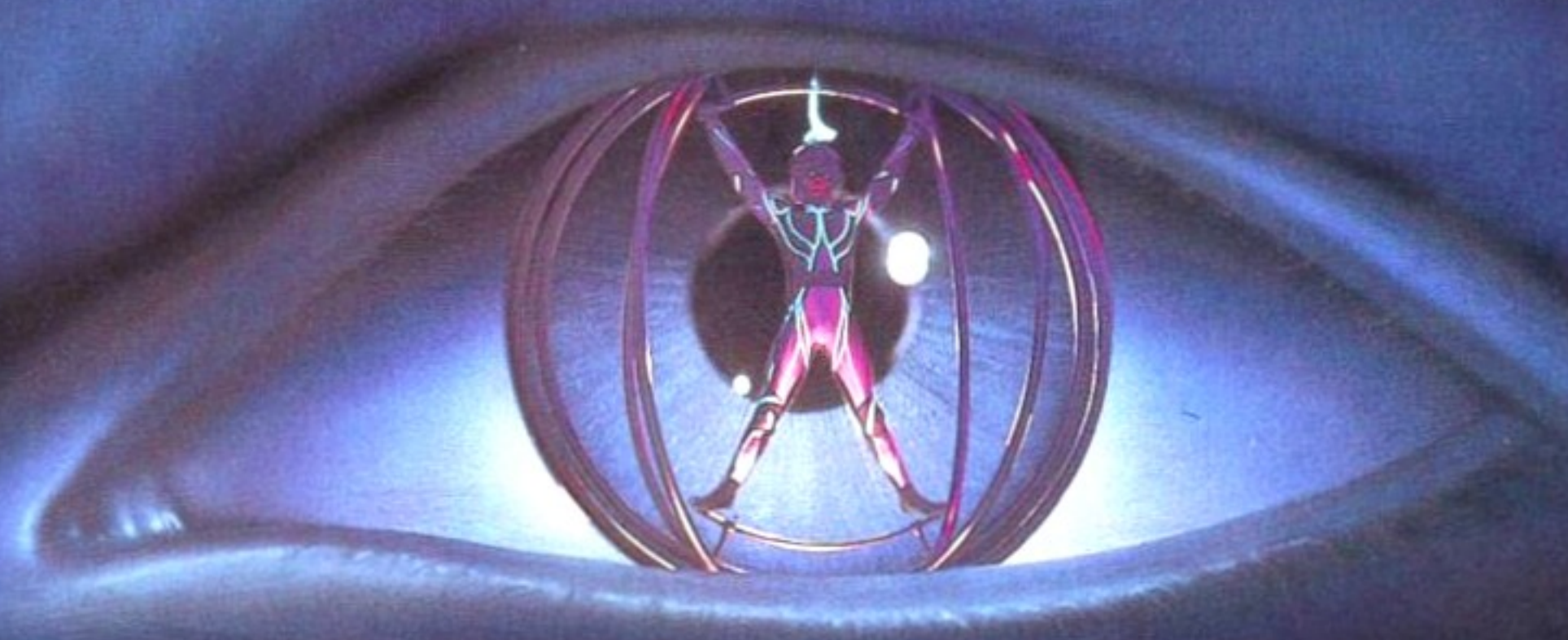

God Made Him Simple. Science Made Him A God.



THE S T E P H E N K I N G ' S LAWNMOWER MAN 15

ALLIED VISION LANE PRINGLE PRODUCTIONS IN ASSOCIATION WITH FUJI EIGHT CO. LTD. PRESENTS A BRETT LEONARD FILM
STARRING JEFF FAHEY AND PIERCE BROSNAN IN STEPHEN KING'S "THE LAWNMOWER MAN" JENNY WRIGHT GEOFFREY LEWIS
MUSIC COMPOSED BY DAN WYMAN EDITOR ALAN BAUMGARTEN PRODUCTION DESIGNER ALEX McDOWELL DIRECTOR OF PHOTOGRAPHY RUSSELL CARPENTER
ASSOCIATE PRODUCERS PETER McRAE MASAO TAKIYAMA CO PRODUCER MILTON SUBOTSKY EXECUTIVE PRODUCERS EDWARD SIMONS STEVE LANE CLIVE TURNER ROBERT PRINGLE
SCREENPLAY BY BRETT LEONARD AND GIMEL EVERETT BASED ON A SHORT STORY BY STEPHEN KING PRODUCED BY GIMEL EVERETT DIRECTED BY BRETT LEONARD

© 1998 Allied Vision Lane Pringle Productions. All Rights Reserved. Read the story in NIGHT SHIFT NEW ENGLISH LIBRARY Paperback FIRST INDEPENDENT A FIRST INDEPENDENT FILMS LTD RELEASE

THE UK'S 1st VIRTUAL REALITY FILM

FROM FRIDAY JUNE 5TH. **ODEON LEICESTER SQUARE** ACCESS/VISA/AMEX Bookings (071) 930 3232 24 hour information 0426 915683 (local call) **ODEON KENSINGTON** ACCESS/VISA/SWITCH Bookings (071) 371 3166 24 hour information 0426 914666 (local call)

ODEON SWISS COTTAGE ACCESS/VISA Bookings (071) 722 5905 24 hour information 0426 914058 (local call) **UCI 8 CINEMAS** WHITELYS OF SAFFORDHAM PROGRAMME INFORMATION (071) 792 3332 081 853 0053 **CAMDEN PARKWAY CINEMAS** Tel. 267-7034 **AND ALL OVER THE COUNTRY** CHECK LOCAL PRESS FOR DETAILS. DETAILS CORRECT AT TIME OF GOING TO PRESS

More Speed. More Memory.



Greater capacity - Greater capabilities.

The protar A 500 HD Series -
The ultimate Hard Disk Drive.
Your Amiga will have capabilities
beyond your wildest dreams.

protar A 500 HD.
Capacity 20 MB - 160 MB.
On-board-RAM Option up to 8 MB.
SCSI-Interface.
1 year replacement warranty.
2 years for Hard Disks with Cache.

Flexible capacity for professionals.
Made in Germany.

Request for further information at
protar Ltd. • Park House • Greenhill Crescent
Watford Business Park • Watford Herts WD1 8QU
Tel. 092 354 133/24 23 07 • Fax 092 321 20 46



Free educational catalogue offer

The largest supplier of educational software in the UK is offering to supply entirely free to **Amiga Format** readers their catalogue, which normally costs £1.

Rickitt Educational Media, based in Somerset, have been supplying educational software to schools and homes for a good many years and are real experts in the field. Their catalogue lists hundreds of titles, including almost every educational program available for the Amiga, and normally costs £1 from newsagents. It comes in full colour with screen-shots of many programs and descriptions to help you choose.

Parents, schools and colleges who would like to receive a copy of the catalogue simply contact Rickitt Educational Media by phone on 0460 57151 or by fax on 0460 53176, or in writing to Rickitt Educational Media, Ilton, Ilminster, Somerset, TA19 9HS.

Look for a book

There's an enormous range of books available nowadays to help you out with any area of Amiga use, from desktop video to programming, from 3D graphics to AmigaDOS and AREXX. But what do you do if your local WHSmith doesn't stock them?

One smart solution is to contact the UK's biggest supplier of computer books and ask for a copy of their catalogue. Computer Manuals, based in Birmingham, publish their *Booklist Magazine* four times a year and the Spring 1992 edition is just out. Give them a ring on 021-706 6000 and they'll be happy to put you on their mailing list.

The magazine contains enormous amounts of Amiga-related books as well as lots for other machines. There's even a whole stack of games-related titles which we haven't seen before, which could be fascinating if you're obsessed with the likes of *Populous*, *Railroad Tycoon*, *Sim City* or a number of flight sims.

V-Lab updated already!



This must be a first, a review of the product and news of the update in the same issue.

The intriguing new composite real-time digitiser *V-Lab*, reviewed in this very issue (Page 138, has already seen one software update: and a second is on its way!

Unfortunately we didn't have sufficient time to update our review, but the digitiser is already on sale with Version 1.2 of the software, which includes a number of enhancements, at no extra cost. Improvements include a substantially larger monitor window, speeded up for improved operation in 16 colours; colour correction features including gamma correction, brightness and saturation filters; new AREXX commands; and a choice when using *V-Lab* with the Amiga Centre Scotland's Harlequin 24-bit card of using Interlace or not.

Music maestro arrives at last!

We've been waiting for it for a long time now, but it seems that the new AD1012 sound card from California-based music specialists Sunrize is here at last.

The AD1012 is essentially a sampling system that operates at 12-bit resolution, allowing sampling rates of up to 100,000 samples a second and recording hours of audio direct to hard disk in real time. It also combines a SMPTE time-code system which will make it ideal for synchronising audio soundtrack with video images.

This kind of sampling power could make it the biggest thing to happen to Amiga audio in a good while. What's more, the card includes variable filters for input and output as well as an effects unit that works in real time, adding such touches as chorus, echo and flanging.

The card also comes with software by the name of Studio 16, which enables the user to cut, copy, paste and mix audio on the hard disk on all four tracks of the system. We're looking forward immensely to getting our hands on one of these, so look out for a review soon. Sunrize 0101 408 374 4962.



The Amiga's most serious music hardware ever, the AD1012, is about to appear.

GVP's easy A500 accelerator is go!

Great Valley Products, who claim to be the world's largest third-party manufacturer of hardware for the Amiga, have extremely ambitious plans to win Amiga 500 owners everywhere over to their A500 HD8+. The hard drive, consistently rated as our favourite by **Amiga Format**, is to be released in a new version that will include a 68030 accelerator and it should go on sale this month.

The great advantage of the system is that the accelerator is included in the hard drive unit and so does not require you to mess about with the main 68000 chip inside your Amiga. This means that it can be switched off, retaining the ability to run ordinary 68000 mode and so ensuring complete software compatibility.

Amiga 500 owners can now have a 68030-accelerated Amiga with 9Mb of RAM and a 100 Mb hard drive all in one compact unit that attaches to the edge connector. Short of a proper 24-bit card, there's little reason to upgrade to a larger Amiga.

GVP are also updating many of the other items in their range, with rumours of larger drives to be fitted to the HD8 series at no extra cost and also definite details of many improvements to their range of accelerators and accelerator combos. We'll bring you further details soon: GVP's official UK distributor is Silica on 081-309 1111 but the 68030-equipped HD8 is being advertised at a special offer price by Skegness dealer MCS (0754 610217): prices start at £699 for the 52 Mb hard drive version, £50 off list price.

Opus improved, Can Do can do more!

US niche-market software house Inovatronics have announced new versions of both their leading programs. *Directory Opus*, claimed to be the best-selling Amiga directory utility, has been tweaked especially to make more of Workbench 2 while the omnipotent multimedia manipulator *Can Do* is given a general all-round revamp.

Directory Opus is an **Amiga Format** favourite: it's one of those simple single-screen control program that gives you all the power of the CLI but at the click of a mouse button, and does a whole lot more besides.

In the new version 3.41 it's been given enhanced recognition of file types, more choice for customising the look and the operation and a number of enhancements for Workbench 2 users. Upgrades direct from the manufacturers cost \$7.50 plus \$6 (\$2 in the US) shipping and handling charge for anyone who's got the most recent version 3.22, or \$29.95 plus the extra charge for older versions.

Can Do is an astonishingly flexible program which tends to be ignored only because it can do too much. It's a powerful and easy way of building your own programs or productions, and in its new version 1.6 it includes direct support for the gameport, making even games a possibility, as well as featuring a number of other tweaks in response to user demand.

The full details can be obtained direct from Inovatronics in America on 0101 214 340 4991 but you could well be better off going through their distributor here in the UK distributor, who are none other than Checkmate Digital 071-923 0658.

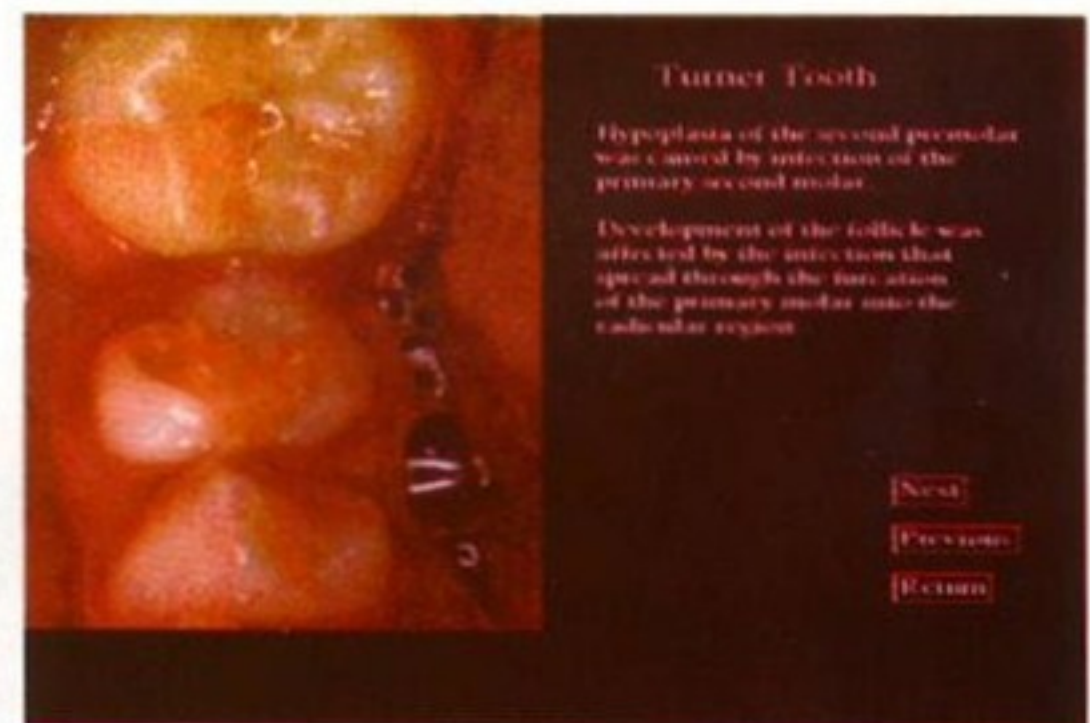

A number of major enhancements should help *Can Do!*, the extraordinarily flexible presentation program, make its mark.

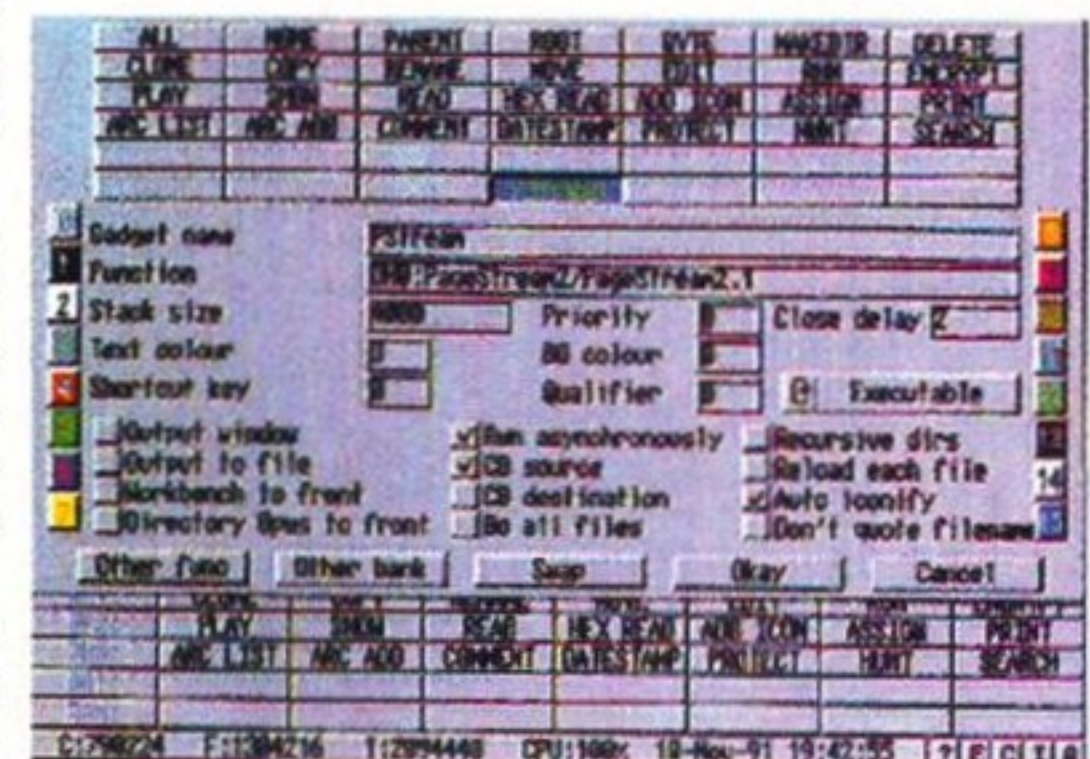

Top directory utility *Directory Opus* is also about to undergo a radical update with a number of enhancements for WB2.

Orders Taken Until

ZYDEC
GOLDSTAR
HEWLETT PACKARD
TOSHIBA
CANON
EPSON
MITSUBISHI
JVC
PANASONIC
DIGITA
SEGA
ABACUS
NAKSHA
GOLDEN IMAGE

NEW DELUXE PAINT III TUTOR VIDEO

Learn to get the best from NEW Deluxe Paint III. This video shows you how to design and execute your own Animations, Titles and so much more in a Step-by-Step, Easy-to-Follow way.

Subjects covered include:

- ★ Screen Painting
- ★ Zoom
- ★ Colours
- ★ Working with Text and Fonts
- ★ Stencils
- ★ Perspective
- ★ Animation
- ★ Video Titling etc, etc.



RUNNING TIME: NEARLY THREE HOURS!!

Superb Value At

ONLY £18.99 inc Post & Packing

"I was a little sceptical about the chances of taking a complete beginner to such artistic heights but I must admit to being wrong" *AMIGA COMPUTING, September 1991.*

DISCS...DISCS...

Phone for latest prices

FULLY GUARANTEED BULK DISKS
DOUBLE SIDED DOUBLE DENSITY 135 tpi
100% Certified - UNBRANDED
USUALLY SONY, TDK or MITSUBISHI etc
GUARANTEED AND SUPPLIED WITH LABELS
DO NOT CONFUSE WITH INFERIOR UNCERTIFIED
PLEASE PHONE FOR LATEST PRICES

20 DSDD	£8.99
50 DSDD	£20.99
100 DSDD	£38.00
200 DSDD	£72.00

Disk Boxes	
Flip Top Disk Holder Holds 12	99p
40 Disk Holder, Lockable, Top Quality, Anti-static, with Dividers & 2 Keys	£3.99
80 Disk Holder, Lockable, Top Quality, Anti-static, with Dividers & 2 Keys	£5.99

DISKS & DISK BOX OFFERS	
Pack of 20 in our top quality, lockable 40 disk holder	£12.99
Pack of 50 in our top quality, lockable 80 disk holder	£26.99

BRANDED DISKS	
10 x Commodore DSDD with labels	£9.99
10 x Sony MF-2DD with FREE Spell Book	£9.99
10 x Precision (by Dysan)	£8.99

Posso Box	
Drawer Type Box - Can be stacked horizontally or vertically - Holds 150 Disks	£16.45

Disk Labels	
Four Assorted Colours	
60 for	£1.00
200 for	£2.00

PRINTER RIBBON RE-INK

Simply open your plastic ribbon case, spray over the ribbon, replace the lid and leave for 24 hours.
BETTER THAN A NEW RIBBON
Guaranteed - Restores dozens of ribbons to new for just...£11.99

DISK DRIVES

K.C.S. Power PC Board - Fits into Ram Exp. Slot under computer. Does not invalidate warranty	£199.99
Adaptor for 1500/2000	£64.99
CUMANA CAX354 1Mb 3.5" Single disk drive - Enable/disable switch - Thru port - Power ex Amiga	£52.99
POWER PC880B DRIVE incorporates Anti-click Board, Blitz Back up system software and built in Virus blocker	£67.99
REPLACEMENT A500 Internal disk drive, fully compatible and with full instructions	£41.99
MEMORY EXPANSIONS & SYSTEM UPGRADES	
512K RAM Expansions with Clock and On/Off Switch	£23.99
1Mb MODULE FOR A500 PLUS Gives 2Mb Chip Memory	£44.99
ROM SHARERS	
Switching from Keyboard	£34.99
or 2 positions Toggle switch	£19.99
KICKSTART ROMS	
V1.3 Kickstart Rom	£29.99
V2.04 Kickstart Rom	£49.99
High Res Denise Chip	£39.99

AMIGA 1500/2000 PERIPHERALS

GVP 52Mb Fast Access Hard Drive with 8Mb RAM board	£274.99
GVP 120Mb Fast Access Hard Drive with 8Mb RAM board	£449.99
GVP - 2Mb SIMMS for above	£64.99
Fitted FREE if required.	
COMMODORE A2300 Internal Genlock	£99.99
A2088 XT Bridgeboard with 360k 5.25" Floppy Disk Drive	£129.99
A2286 AT Bridgeboard with 1.2Mb 5.25" Floppy Disk Drive	£329.99

AMIGA's

OUR LOWEST AMIGA PRICES EVER!!!
ALL OUR AMIGA PRICES INCLUDE
FREE NEXT WORKING DAY DELIVERY

AMIGA A500 PLUS ONE MEG CARTOON CLASSICS PACK
Latest pack from Commodore featuring: Kickstart V2 & Workbench V2.04, built in 1 Meg RAM, TV Modulator & Mouse, plus Lemmings, Simpsons, Captain Planet and Deluxe Paint III.
Our best price including Next day delivery...£339.99

NEW AMIGA A600 NEW COMPACT DESIGN
Kickstart/Workbench 2.05 internal 3.5" Disk Drive & IDE Hard Disk Controller, built in TV Modulator, Composite Video Output, Smart Card Slot, 2 joystick/Mouse ports. FREE ability to use memory cards of 0.5Mb to 4Mb. Introductory price including one year on-site maintenance for in-home service and Deluxe Paint III and free game...£384.99

NEW AMIGA A600 HD
Similar to above but with built in 20Mb Hard Drive, introductory price including one year on-site maintenance for in-house service...£479.99

CARTOON CLASSICS SOFTWARE ONLY PACK
Lemmings, The Simpsons, Captain Planet and Deluxe Paint III...Only £59.99

ESSENTIAL ACCESSORIES PACK
Top quality 40 disk holder, 10 best quality disks with labels, quality mouse mat, mouse holder, tailored monogrammed dust cover. Special price...£21.99

Extra special price if bought with any Amiga...£19.99
Ring for details and latest quote

AMIGA 1500/2000
12 months on-site warranty available on all new Amiga 1500/2000 systems...Only £59.99

AMIGA 1500 STARTER PACK
Amiga 1500 Dual drive with 1Mb RAM, Mouse, Manuals and Amiga DOS. The Works - Platinum Edition, Deluxe Paint III, Home Accounts, Elf, Toki and Puzznic.
Total RRP £699.99...Audition Price £549.99

AMIGA 1500 STARTER PACK
Plus 1084S Stereo Colour Monitor
Total RRP £959...Audition Price £774.99

AMIGA 1500 STARTER PACK
Amiga 1500 Dual drive with 1Mb RAM, Mouse, Manuals and Amiga DOS. The Works - Platinum Edition, Deluxe Paint III, Home Accounts, Elf, Toki and Puzznic 1.3 Workbench Model (Upgradeable)...**Special Audition Price of £499.99**

AMIGA 2000
1 meg RAM, Dual 3.5" Drives, Kickstart/Workbench 2.04. Fitted with 40Mb Hard Drive **SPECIAL PRICE including NEXT DAY DELIVERY...£689.99**

C.D.T.V
Complete with Hutchins Encyclopaedia, Lemmings and Welcome CD Disk...£449.99
C.D.T.V Keyboard...£49.99
C.D.T.V External Amiga Disk Drive...£79.99

AMIGA 2000 PLUS MS-DOS XT EMULATION
Amiga 2000 Dual drive with Commodore A2088 XT Bridgeboard and 5.25" MS-DOS Floppy Drive.
Total RRP £1229...Audition Price £699.99

AMIGA 2000 PLUS MS-DOS AT EMULATION
Amiga 2000 Dual drive with Commodore A2286 AT Bridgeboard and 5.25" MS-DOS Floppy Drive.
Total RRP £1449...Audition Price £899.99

AMIGA 2000 PVP VIDEO PRESENTATION SYSTEM
Amiga 2000 Dual Drive with 52Mb Quantum Fast Access Hard Drive SCSI High Speed Controller, A2300 Internal Genlock, Deluxe Paint III, Scala Presentation Software, Video Cables and presentation video.
Total RRP £1299...Audition Price £1049.99

Commodore 2300 Internal Genlock...£99.99

AMIGA 500 HARD DRIVES

GVP 52Mb Hard Drive Plus 8Mb RAM Board	£349.99
GVP 105Mb Hard Drive Plus 8Mb RAM Board	£459.99
GVP COMBO 40Mhz Accelerator Plus 52Mb Hard Drive Plus 8Mb RAM Board, all in one case	£689.99
GVP 2Mb Simms for above	£64.99
Fitted FREE if required	

PRINTERS

We are CITIZEN SUPER DEALERS and Authorised to offer their Full 2 Years Guarantee on all CITIZEN Products. This Guarantee covers all parts and labour including Print Head. We will also give, on request, a FREE drivers disk to enable you to use your Citizen printer to be perfectly matched to your Amiga.

PLUS WE ARE ADDING FREE OF CHARGE OUR OWN PRINTER STARTER KIT WORTH £30 WITH EVERY CITIZEN PRINTER.

CONSISTING OF:

- ★ 200 Sheets Quality Paper
 - ★ 200 Sheets Continuous Paper
 - ★ 200 Tractor Feed Address Labels
 - ★ 2 Metre Amiga Printer Cable
 - ★ Special Citizen/Amiga drivers disk to match your Amiga perfectly to the Swift Colour Printers.
- With this kit your printer is ready to go - no more to buy - just plug in.

PANASONIC KXP 1124i

Very high quality 24 pin printer with 7 letter quality fonts and 1 Super Letter Quality font. Easy to use liquid Crystal Panel. Special Price including FREE Starter Kit...£249.99

PANASONIC KXP 1170

High quality 9 pin printer with 6 near letter quality fonts and single or tractor feed paper option and paper track. Special price including FREE Starter Kit...£149.99

NEW STAR LC24/20

Versatile low cost 24 pin letter quality printer - 10 fonts, easy to use liquid crystal display. Special price including FREE Starter Kit...£229.99

CITIZEN SWIFT 9

Colour High Spec. 9 Pin with 4 Fonts and 240x240 dpi graphics...R.R.P £325
Starter Kit...R.R.P £30
Total Value...£355

Audition Special Deal with FREE Starter Kit...£209.99 PLUS FREE NEXT WORKING DAY DELIVERY!!!
and full 2 year guarantee, you save £145

CITIZEN 224

Colour High Spec. lowest cost 24 Pin colour printer on the market
24 Pin for Perfect Quality text and 360 x 360 dpi Graphics...R.R.P £360
Starter Kit...R.R.P £30
Total Value...£390

Audition Special Deal with FREE Starter Kit...£259.99 PLUS FREE NEXT WORKING DAY DELIVERY!!!
and full 2 year guarantee, you save £203

CITIZEN SWIFT 24E

Colour High Spec. 24 Pin Perfect Quality text and 360x360 dpi graphics...R.R.P £475
Starter Kit...R.R.P £30
Total Value...£505

Audition Special Deal with FREE Starter Kit...£299.99 PLUS FREE NEXT WORKING DAY DELIVERY!!!
and full 2 year guarantee, you save £203

NEW THE NEW CITIZEN PROJET INKJET PRINTER

Laser quality without the cost, 3 built in fonts and auto sheet feeder for high speed near silent printing with superb quality...R.R.P £585
Audition Special Deal with 500 sheets of quality paper...£399.99 PLUS FREE NEXT WORKING DAY DELIVERY!!!
and full 2 year guarantee, you save £182

GENUINE CITIZEN ACCESSORIES

Including all ribbons, stands etc, Memory upgrades etc. Details on request.

STAR PRINTERS

STAR LC20 Mono 9 Pin Mono Printer - reliable and good quality printer - 3 fonts. An ideal first printer.
Audition Special Deal with FREE Starter Kit...£139.99 PLUS FREE NEXT WORKING DAY DELIVERY!!!

STAR LC200 Colour 9 Pin Colour Printer 8 fonts.
Audition Special Deal with FREE Starter Kit...£199.99 PLUS FREE NEXT WORKING DAY DELIVERY!!!

STAR LC24/200 Mono 24 Pin Mono Printer 10 fonts.
Audition Special Deal with FREE Starter Kit...£239.99 PLUS FREE NEXT WORKING DAY DELIVERY!!!

STAR LC24/200 Colour 24 Pin Colour Printer 10 fonts.
Audition Special Deal with FREE Starter Kit...£269.99 PLUS FREE NEXT WORKING DAY DELIVERY!!!

INKJET PRINTERS

CANON BJ10E Portable Bubble Jet Printer with 3 fonts, Cable etc	£229.99
CANON BJ10E Ink cassette	£17.99
CANON BJ300 Bubble Jet Printer, Single Sheet and Tractor Feed	£499.99
CANON BJ300 Ink cassette	£13.99
Just in	
Special Price	
COMMODORE MPS1270 Ink Jet Printer	£129.99
PANASONIC KXP1170 High Quality 9 Pin Printer	£149.99

12.00 Midnight

We have now moved to a 1000 Sq ft Superstore, packed with Computer Hardware and Software and invite all our customers and friends old and new to pay us a visit. Make a day of it, in one of Englands loveliest Old Towns

AMIGA BOOK SPECIALS

Amiga Advanced Systems Prog Guide	£29.95
Amiga Applications	£16.95
Amiga Assembly Language Program	£12.95
Amiga BASIC Inside & Out	£18.95
Amiga C for Beginners	£17.95
Amiga Companion	£16.95
Amiga Desktop Video Power*	£24.95
Amiga Desktop Video Guide	£16.95
Amiga Desktop Video Workbook*	£29.95
Desktop Video Production	£13.95
Amiga DOS a Dabhand Guide	£14.95
Amiga DOS Inside & Out	
Revised Edition with Disk	£23.95
Amiga DOS Manual - 3rd Edition	£18.95
Amiga DOS Reference Guide 2nd Edition	£5.95
Amiga DOS Reference Guide 3rd Edition	£17.95
Amiga DOS Quick Reference	£8.95
Amiga Graphics Inside & Out	£29.95
Amiga Machine Language	£14.95
Amiga Printers Inside & Out	£28.95
Amiga Programmers Guide	£16.95
Amiga Programmers Handbook Vol 1	£23.95
Amiga Programmers Handbook Vol 2	£22.95
Amiga 3D Graphics Programming in BASIC	£16.95
Advanced Amiga BASIC	£16.95
Becoming An Amiga Artist	£16.95
The Best Amiga Tricks and Tips*	£24.95
Elementary Amiga BASIC	£14.95
First Book of the Amiga	£16.95
Second Book of the Amiga	£16.95
Get the Most Out of Your Amiga Vol 2	£9.95
Get the Most Out of Your Amiga Vol 2*	£13.95
Screen Play	£9.95
Screen Play 2	£9.95
Inside the Amiga with C	£19.95
Inside Amiga Graphics	£16.95
Kids and the Amiga - 2nd Edition	£14.95
Making Music on the Amiga*	£29.95
Mapping the Amiga	£19.95
Mastering Amiga DOS 2 - Volume 1*	£21.95
Mastering Amiga DOS 2 - Volume 2	£17.95
Using Deluxe Paint - Second Edition	£18.95
Programming the 68000	£22.95
68000 Assembly Language Prog	£21.95
MC68000 Programmers Reference Man	£8.95
Amiga C: A Dabhand Guide	£14.95
Learning to Fly with Flight Sim	£12.95
Amiga for Beginners -	
New version W/B 1/3 & 2.0	£12.95
New version W/B 1/3 & 2.0	£12.95
Using AREXX on the Amiga Plus*	£29.95
More Amiga Tricks & Tips	£18.45
GPA Basic Interpreter with Disk	£19.99
Learning C: Programming Graphics on the Amiga	£16.95
Amiga ROM Kernel Ref Manual	
3rd Edition Includes and Autodocs	£34.95
Amiga ROM Kernel Ref Manual	
3rd Edition Devicos	£32.95
Amiga ROM Kernel Ref Manual 3rd Edition Libs	£31.95
Amiga Hardware Reference Manual - 2nd Edition	£10.00
Amiga Hardware Reference Manual - 3rd Edition	£25.95
Computer Viruses & Data Protect	£16.95
Mastering Amiga Beginners*	£19.95
C: A Dabhand Guide	£14.95

* = with FREE DISK

SOFTWARE SPECIALS

ProWrite Word Processor	£49.95
Infofile Database	£29.95
Amiga Logo and Talking Turtle	£14.99
Music Mouse	£14.99
Rombo RGB Colour Splitter	£59.95
Online Fonts	£99.99
Deluxe Print II	£34.95
Captain Planet	£4.99
Deluxe Paint III	£19.99
Photon Paint	£9.99
Lets Spell at Home	£9.99
Photon Paint II	£24.99
GFA Basic Interpreter	£24.99
TV Show/TV Text... Video Titler and Special Effects	
R.R.P £159.99	SPECIAL PRICE £49.99
Amiga Vision... Presentation and Multimedia Software	
R.R.P £111.99	SPECIAL PRICE £49.99

SERIOUS SOFTWARE

Wordworth v1.1 from Digita	£74.99
Scala 500	£89.99
Scala (Needs) 1.5Mb Ram & Hard Drive	£169.99
Show Maker	£174.99
Professional Page 2	£169.99
Prowrite 3	£87.99
Gold Disk Office	£63.99
Pen Pal	£54.99
GB Route Plus	£59.95
Design Works	£57.99
Quarterback	£46.99
Quarterback Tools	£59.99
Home Accounts	£19.99
Home Accounts 2	£36.99
X-Back Up Pro	£35.99
Mavis Beacon Teaches Typing	£19.99
Pagesetter II	£46.95
Amos	£32.49
Amos Compiler	£19.49
Amos 3D	£21.49
Easy Amos	£39.99
Turob Print Pro	£44.99

EDUCATIONAL SOFTWARE

Fun School 2 - Under 6	£12.45
Fun School 2 - 6-8 Years	£12.45
Fun School 2 - 8 and Over	£12.45
Fun School 3 - Under 5	£15.45
Fun School 3 - 5-7 Years	£15.45
Fun School 3 - 7 and Over	£15.45
Fun School 4 - Under 5	£16.45
Fun School 4 - 5-7 Years	£16.45
Fun School 4 - 7 and Over	£16.45

KOSMOS

Answer Back Junior	£14.45
Answer Back Senior	£14.45
Fact File 500 - 20th Cent. History	£7.95
Fact File 500 - General Science	£7.95
Fact File - Spelling	£7.95
Fact File - Sport	£7.95
Fact File - Arithmetic	£7.95
Fact File - Association Football	£7.95
The French Mistress	£14.45
The Italian Tutor	£14.45
The German Master	£14.45
The Spanish Tutor	£14.45
Maths Adventure	£19.99

L.C.L.

Micro English (GCSE)	£18.95
Micro French (GCSE)	£18.95
Micro Maths (GCSE)	£18.95
Mega Maths (A Level)	£18.95
Primary Maths (3-12)	£18.95
Reading & Writing (3-8)	£17.95

MISC

BBC Emulator	£35.99
Amiga Logo	£14.99
Better Maths (12-16) GCSE	£16.99
Better Spelling (8-Adult)	£16.99
Mavis Beacon Teaches Typing	£19.99
Lets Spell at Home-SPECIAL	£9.99
Fact File 500 - Know England	£7.95
Fact File 500 - English Word	£7.95
Fact File 500 - Natural History	£7.95
Fact File 500 - World Geography	£7.95
Fact File 500 - First Aid	£7.95

DUST COVERS

Top Quality Amiga Colour Dust Covers. Tailored, Monogrammed and with Bound Edges. Protect Your Investment

Amiga Keyboard	£4.99
Citizen 120D Printer	£4.99
Citizen Swift 9/24/124D	£4.99
Commodore Monitor	£4.99
Philips Monitor Mk II	£4.99
Amiga 1500 Two Part Cover	£8.99
Star LC10 Printer	£4.99
Star LC200 Printer	£4.99
Star LC24/200 Printer	£4.99

EXCLUSIVE

THE AMIGA TUTOR VIDEO

For new and not so new Amiga users - shows in clear graphic detail all you need to know to become proficient in using the Amiga.

Subjects covered include:

- ★ Setting Up and Connections
- ★ The Workbench Fully Explained
- ★ How to Customise the Workbench
- ★ Copying, Renaming and Formatting Disks
- ★ The Notepad, Fonts, Saving and Printing
- ★ Clock, Sizing and Moving Icons
- ★ Pull Down Menus and Scrolling Windows
- ★ CLI Directory Structure
- ★ Editing the Start-Up Sequence
- ★ Printer Set-Up and Preferences etc, etc.



Don't struggle with the manuals - watch as we show you HOW - all for the cost of a game.

1000's Sold... Available only from AUDITION

ONLY £19.99 inc Post & Packing

"Excellent... A great help... Sensibly it teaches... you about the most practical areas - the ones you will need. Range of topics covered is wide and, above all, practical... Put together by people who know a fair amount about the Amiga" *AMIGA FORMAT, January 1991.*

"Excellent... Simple answer to many tricky problems... I found the video excellent. May even teach an old dog a few new tricks... Certainly for anyone taking their first Amiga steps it's well worth the asking price. If only such a thing was available in my formative years" *AMIGA COMPUTING, February 1991.*

MONITORS

Philips CM8833 Mk II Colour Monitor, High Resolution, Twin Speaker Stereo complete with all Leads and One Year on-site Warranty with FREE F19 Stealth Fighter Simulator £229.99

NEW Commodore 1085 SD2 Stereo Colour Monitor £229.99

Goldstar Colour 40 Channel Monitor/TV with full remote control and includes Amiga Scart Leads £179.99

Please note that all our monitors are official UK specifications. We do not sell grey imports of any kind

MONITOR SPECIAL

Philips 15" TV Monitor, FST Screen, 40 Program Memory, Eurocart Connector & Leads

2000 Character Fine Picture Resolution

Sleep Timer, Auto Programming

2 Year Guarantee and with Full Remote Control

For Superb TV Picture and all leads included for use as Amiga Monitor £199.99

Genuine Philips Tilt & Swivel Monitor Stands £16.99

NEW Commodore 1085 Stereo Monitor £229.99

JOYSTICKS

QUICKSHOT Python Turbo III	£9.49
QUICKSHOT 3 MicroSwitched QS137F	£9.99
QUICKSHOT DIGITAL APACHE 1 QS131	£7.49
QUICKSHOT FLIGHTGRIP 1 QS129F	£9.49
QUICKSHOT GAME CON. QS128F	£14.99
SIGMA RAY Autofire	£13.49
POWER PLAY BLACK	£9.99
COMPETITION PRO 5000 Multi Col	£11.99
COMPETITION PRO COMBAT Slo/Mo	£12.99
KONIX Speedking Auto	£12.49
ZIPSTICK Superpro Auto	£12.99
QUICKJOY SV-129 FOOT PEDAL	£24.95
VOLTMACE DELTA 3A Analogue. Ideal for Flight Simulators	£14.95
GRAVIS CLEAR	£36.99
TROJAN LIGHT PEN	£39.99

AUDITION COMPUTER SERVICES

Telephone direct to our mail order hotline. All major credit cards accepted. Quote your number and expiry date. Same day despatch.

Send all forms of payment made payable to Audition Computer Services. With your order please send your name, address and daytime telephone number. Along with your detailed order requirements. Goods will be sent by post, free of charge immediately after cheque clearance

Next day delivery available for small additional charge, please phone for details

Dept AMF, 35 Broad St, Stamford, Lincs, PE9 1PJ.

Tel: 0780 55888 Shop Hours 0780 720531 Out of Hours

Switch Cards Welcome



COMMODORE ATARI CITIZEN STAR AMSTRAD CUMANA PHILIPS GOLDEN IMAGE NAKSHA ABACUS SEGA PANASONIC JVC

Most people who own an Amiga are very impressed with the machine, but less than satisfied with the results they obtain. It often seems that, before you can get any worthwhile results out of it, you have to spend months learning how to use creative tools like Deluxe Paint.

Make it easy on yourself

AMIGA FORMAT

26

JUNE 1992

THE INTRODUCTION OF the Amiga has brought about a revolution, in terms of the capabilities of the machine. Brilliant sound, lovely graphics, and with Workbench 2 a really usable and friendly machine. But a computer is useless without people who can get the best out of it, and that's where you come in.

Most people who own an Amiga are very impressed with what the machine can do, but less than satisfied with the results that they obtain. It often seems that, before you can get any worthwhile results out of it, you have to spend months learning how to use creative tools like *Deluxe Paint* before you start producing anything that looks impressive. Which is a shame, because you are the people in control of the Amiga's future – what you use the machine for today helps shape what you can use it for tomorrow.

That's where this feature comes in. Too often, people don't realise the shortcuts, back alleys and outright cheating methods and they get bogged down in detail, wasting time by doing everything by hand. There's nothing wrong with high standards – but you want to see quick results in order to gain confidence.

Of course, the average quality of work done on the Amiga is climbing all the time, especially with products like *VistaPro 2* (reviewed on Page 150). Nobody can pretend that using an Amiga is a piece of cake from day one. Hopefully though, by reading these pages you'll gain a few insights into getting better results faster than you ever dreamed possible, whether you're into graphics, music, desktop publishing or general Amiga usage.

So what exactly do we mean by cheating? The exact methods vary with what you are trying to do, but the general principles are; find an existing picture, sound, font or piece of clip art, used before by somebody else; edit it to taste; and include it in your own work. There can be legal problems with this if the original designer doesn't like what you're doing, so we'll explain clearly exactly how far you can bend the rules. But never, never rip somebody off word for word and line for line; always add



something of your own, otherwise you'll be rumbled straight away.

Finally, a word of caution. Don't think that you can cheat and get away with it for ever. We're not about encouraging people to cheat as a daily routine. If in years to come you develop your Amiga work into a fully-fledged career, don't think that you can rip people's ideas off without being found out. The higher the profile and prestige you have, the less you can cheat – but everybody who gets anywhere cheats somewhere along the line. And don't you believe otherwise.

You didn't seriously think that every single Amiga graphic was drawn from scratch, did you? Of course not! But very, very few people can draw without reference to source materials of some kind. It's very difficult to draw anything without a model or picture of it in front of you. But making your life easier can go much, much deeper than that.

Let's say that you want a picture of, for example, a person walking along, viewed from the side. You could draw it by hand. But with an Amiga, there are lots of different approaches – none of which is the 'right' one.

THE LEGAL ANGLES

Strictly speaking, you are not allowed to digitise anything with a copyright message on it, so source material for digitising is limited to any images you've recorded yourself using a camera (video or film) or sounds you've done yourself. In addition, all promotional material (advertising such as trailers for forthcoming programs) are Public Domain, and can be used freely.

Now, you can go outside of this (especially if what you are doing is for your own private use) but do be aware of the ramifications. Most bodies are not bothered about using the odd image or font, but strictly speaking you should get the written permission of the copyright owner before releasing your work.

The best approach is to use common sense. Do your work first and complete it, and before you release it to public view, send a copy (don't assume the copyright holder will have an Amiga) to the copyright holder, crediting the use of their image or whatever and asking for their permission to release your work. Be persistent and polite, and nine times out of 10 they will say yes.

The problem is that, due to the nature of the Amiga, people have been ripping off copyright left right and centre, and so newcomers assume that it's permissible. Just because a law is largely unenforceable with regards to a computer doesn't mean it's a null law. So always get copyright permission before using other people's work, if you want to be sure that no legal suits will arise in future. You could be the test case...



The picture below was produced with the aid of some *Real Things* coloured animbrushes. Notice how the zebras are all copies of the same shape. It's amazing what you can do with *Deluxe Paint* and some clip art.



You could do a video of someone walking along, and then digitise each frame from the video into a separate IFF picture. Or you could buy the *Real Things Humans* pack, which has a ready made colour IFF Anim brush, ready to stamp down onto a background. Or you could take single picture prints, and scan them in with a hand scanner.

Sure, it takes some know how and perhaps some expenditure. But we're not talking lots of cash, and this feature has been designed to help you spend money wisely.

Understand that there is a huge amount of material that is easily obtained already – you don't have to spend a fortune on hardware to start using other people's pictures and sounds, and that's because of the system known as the Public Domain.

The PD, as it's usually called, is a huge pool of programs and files donated by Amiga enthusiasts for the use of Amiga enthusiasts. Now, I'm not going to say it's free, because it isn't. It is, however, the cheapest way of getting some data to play with.

The PD is maintained by companies called libraries. These vary in size from one person operating out of their living room up to fairly large groups like 17 Bit, who got so big they managed to form their own software house,

Team 17. But that's a different story. PD libraries are in business to collect programs and data disks, old and new, to redistribute to whoever asks for them for a small fee to cover postage and copying charges – typically just one or two pounds.

The PD libraries always have catalogues, sometimes printed but mostly on a disk. It's usually much easier to browse through a disk catalogue – for instance, you just ask it for all the disks with DTP in the description, and it will give you a list. Bearing in mind that some PD libraries have literally thousands of disks, it can be very time consuming to go through a list on paper.

If you want to cheat hardest, there is another option too. Say that you have a game or a PD demo, which has a picture or a sound sample on it. Now you most probably won't be able to load the data straight from the floppy disk, because it will almost certainly be embedded in the program. By using a utility called a ripper though, you can scan through

leagues ahead, because what they do is so flexible and adaptable to different people's needs.

However, Zero-G are now providing ready made sound samples, Genisoft can offer ready made clip art as can Digita International and, most importantly, Agfa releasing a range of Compugraphic outline fonts on the Amiga are all pointing towards a huge growth area, which has been built up on the efforts of PD enthusiasts in the early years.

Often, you'll come across an image or hear a sound and think "I could make use of that". The Amiga has unrivalled capacity for using real-world images, but understand that the basic machine can only display pictures and play sounds – if you want to read them into the machine, you will require some additional hardware gadgets.

The reason for this is that the Amiga is a computer, and computers only understand numbers (digital information) whereas real world information is stored in relative terms (analogue information). Such hardware converters are classed as analogue to digital converters, or digitisers for short. Three main types exist; the video digitiser, for grabbing pictures from a video recorder or camcorder; the sound digitiser, usually called a sampler, for converting sounds from a microphone, CD or music tape; and the scanner, for reading in flat pictures and other printed material.

Obviously, exactly how much of this real world material you use determines how much you have to spend. If you just want to get into the game, for instance sequencing sampled sounds, then a PD utility like *ProTracker 2* (reviewed on Page 159) or *OctaMed* and a couple of PD sample disks will do the job. If you have a huge stack of CDs and want to grab individual sounds, then a sound sampler cartridge is a must.

A word of caution. Remember that digital representations of the real world are very large in computer terms. Don't think that you can happily use lots of interlaced, overscan, larger than normal colour images on a 1Mb Amiga. If you have such a machine (and most people do) it's a good idea to use images with fewer colours or short sound samples, to get around memory limitations.

The thing to remember is that although a standard 1Mb Amiga can play songs and show pictures, to edit or create such productions, you will face some limitations. Nonetheless, it's well worth seeing just what the basic machine can do – and for that, all you need is a copy of *Deluxe Paint*, a bit of clip art perhaps, and some time to see how to rearrange and use material done by somebody else.

The good thing about the Amiga is the standardisation of data formats – in other words, if you take a picture done with *SpectraColor Jr* from this month's disk, you can load it into any other HAM (4,096 colour) paint program.

If you work with short sound samples and pictures with just a few colours, compatibility is even better. So start thinking, not about how you do things (we'll get to that later) but about what you want to do: general graphics work, sound and music, or DTP.

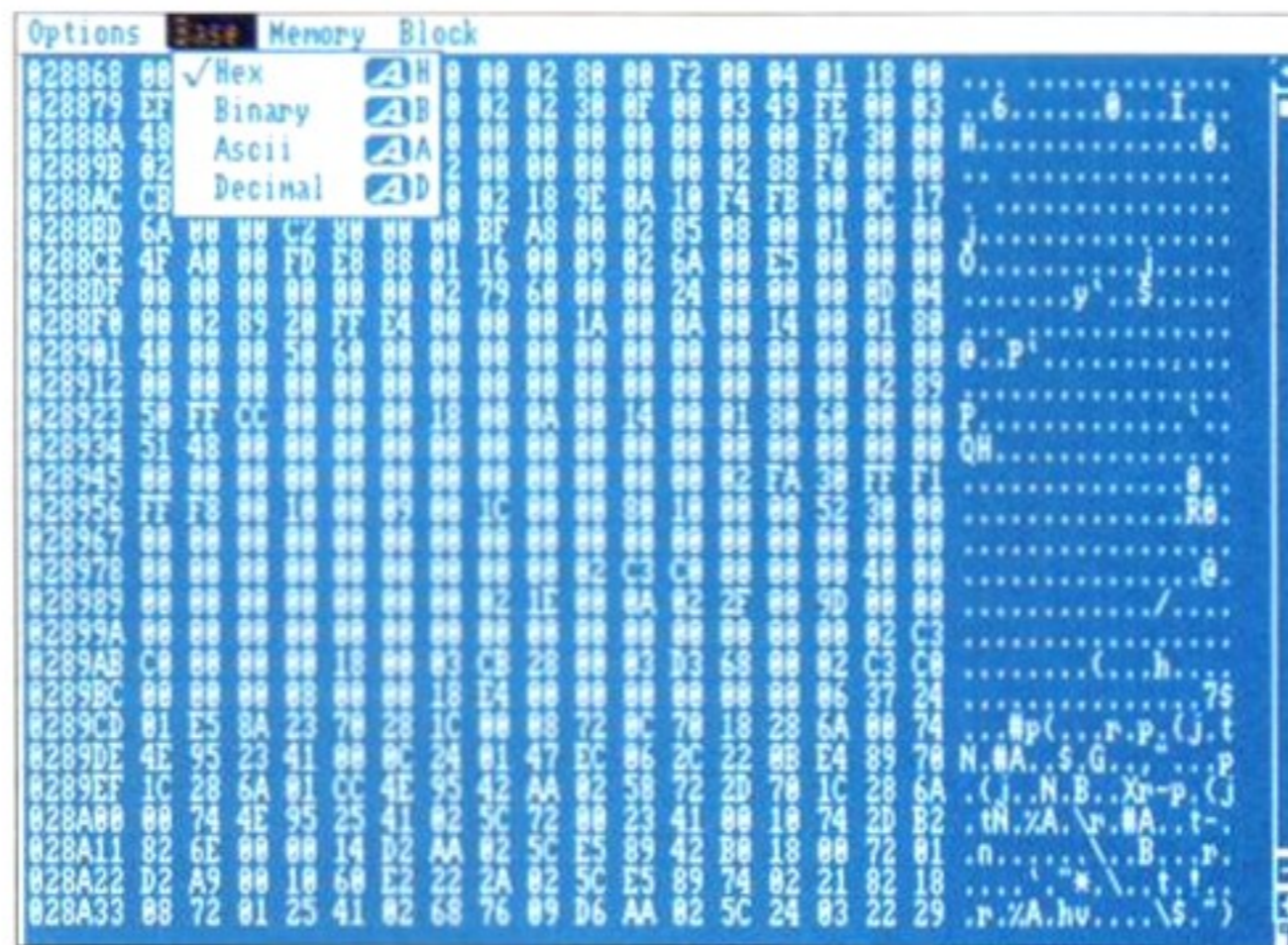

What's this a picture of? Well, in case you didn't know, this is how the Amiga views data like sound samples, clip art, and fonts – it's really just large sets of hexadecimal numbers.

the Amiga's memory, and take out what you can find. More on rippers later.

A growing amount of companies are realising the huge potential of selling clip art, samples and fonts for use in existing software. After all, it's much easier to set up data disks than it is to write software.

Notable players in this area are *Real Things*, who release animbrushes for use with *Deluxe Paint* or similar paint-and-animation facilities. In the cheating stakes, they are

Graphics

There's an awful lot more you can do with pictures than just twiddle around in Deluxe Paint, and it can be easy to get amazing results...

GETTING IT

For the budding "cheater" there's a huge amount of graphical stuff, just begging to be copied over to your Amiga. There are two basic places where you'll find graphics to cheat with. The first is on paper: literally tons of artwork is available for you to scan in and retouch. Magazines and newspapers are full of the stuff and if you pick the right images you won't break any copyright laws. If you're not intending to reproduce "borrowed" images exactly, or pass them off as your own, you can find useable pictures everywhere: adverts, flyers, posters, books, and even junk mail. To transfer them into your Amiga, you'll need access to a scanner (either a flatbed or a handheld machine) and some controller software which is usually the Amiga-specific part.



This is as good as you can get on an Amiga without buying a 24-bit graphics card. This image is from Nik Williams Pictureware library – he uses the quite cheap DigiView Gold digitiser and a Sony M7 broadcast quality camera (list price about £30,000!)

The second (and most appealing) place to find images is video. Almost all cinema trailers and promotional videos are public domain, so these are the places to grab images of your fave characters like the Terminator or Robocop. You can also grab from TV, the best sources being adverts, news bulletins and sports programs – avoid films. By far the best option is to digitise your own work, but to do this you'll need access to a video camera or camcorder. This way you can be far more creative, without transgressing any copyright laws, and produce more interesting results. This is usually because you can set up shots the way you want them to look on your Amiga, and your "actors" can be instructed to stand, move or wobble about as required.



If you try digitising from video material with lots of lighting changes, movement, and an irregular sound track (music videos and sports programs are the worst) you'll see results like this. Blurred, far too much red, and video scan lines breaking up the picture. Avoid this sort of material!

TWEAKING IT

Once you've grabbed an image, whether it's a scan or a video-grab, chances are you'll need to tweak it a bit to make it useable. Virtually all hand-scanners digitise in black and white, using half-tones (tiny dotted patterns in varying densities) or grey scales (colour tones represented in 16 shades of grey). It's pretty likely that you'll want the finished Amiga image to be full-coloured, so you'll need an art package (like *DPaint*) to re-colour it. It's easier to colourize grey-scale images (especially in HAM mode, though it can take a while) than half-tone monochrome images (which can be hell to work with if there's a lot of tonal variation). With scans, you may find you have to resize the image to fit onto the Amiga screen; they may be scrollable in *DPaint*, but that's not much use if you're concocting a stand-alone demo.

Re-sizing is also best done with *DPaint*'s size function (and you can use the left Amiga key to keep the aspect ratio of the image the same while you size it).



This picture, by our very own Maff Evans using *Deluxe Paint IV*, started life as a black and white scan of King Tut. Using a custom palette to turn the grey scales into colour is very time consuming.

With video images (which can be either colour or monochrome) there is generally less work to do, but unlike scans, video-grabs often have unnecessary background details which you may want to cut out. This kind of work is also best done in an art package like *DPaint*. It's possible that you may need to reduce the number of palette colours used by colour video-grabs, especially if you intend to combine various video-grabs on the same screen. The background to foreground (BG>>FG) command is the easiest way of doing this, as it frees up palette slots.

PROBLEMS



This is a slightly retouched picture of *Pixmate* in action. *Pixmate* is an image processor, and is dead handy for taking HAM images down to use less colours or just finding the outlines in pictures.

Monochrome half-tone scans are best avoided because they don't contain any real colour information. The half-tone dot patterns give the illusion of shades, but only because some areas are more dense than others. Consequently, if you alter one of the two colours, you just get a new overall shade rather than a coloured area. To colourize a half-tone image you effectively have to re-draw a new image over the top of the old one – which is nearly (but not quite) as difficult as drawing the thing from scratch. Stick to grey-scale images if possible. While most monochrome video-grabs use simple grey-scales, colour ones are often in HAM mode. Working in HAM can be a nightmare, partly because the memory required is large, and partly because the amount of colours used in the image means that there's an awful lot of tweaking to do if you want to make changes. If your digitizer expects you to use separate red, green and blue filters when digitising colour pictures (like the Rombo VIDI-Amiga), you will also require an RGB splitter to separate the primary colours in video signals – the digitizer's software should put them back together in the finished image. Real-time colour digitizers like the Marcam Frame Grabber 2 don't need splitters because they are designed to cope with composite video signals.

Do be aware that you are not necessarily limited to pictures produced on the Amiga. Using the excellent *CrossDos v4*, you can exchange files with the IBM PC type of computers. IBM PCs don't use IFFs – they use either PCX, GIF, or one of a number of other formats. There are plenty of PD utilities that will translate PCX or GIF images into IFF for use on the the Amiga – and there is plenty of PC PD clip art available in such formats. If you're not sure about this different file business, take a look at the In-depth Explanation box, contained within the Answerfile section on Page 203. That should make things a bit clearer for beginners.

FROM THE PROGRAMMERS WHO GAVE YOU RAINBOW ISLANDS...

FIRE & ICE

THE DARING ADVENTURES OF COOL COYOTE



AMIGA VERSION SHOWN

- With all the levels, power-ups, bonuses, features, hidden secrets and multiples that you'd expect from award-winning Graftgold •

"BEAUTIFUL AND EVOCATIVE...STANDS UP PROUD AMONGST THE BEST OF PLATFORM GAMES." Amiga Power

"THE BEST PLATFORMER SINCE RAINBOW ISLANDS." The One 92%

"A MUST BUY." 90% CU Amiga Screenstar



The Digita range...

Home Accounts2®

An advanced version of Home Accounts, which is limited only by the capacity of your computer. Sophisticated reporting with graphics, and special options such as VAT and loan calculation facilities. Equally suitable for businesses, clubs and charities (ST and Amiga). **£54.99**



Home Accounts

Ideal for home users who want a simple low-cost way to plan and manage home finances. **£29.99**

DGCalc

This fast, simple spreadsheet includes many advanced features, including a windowing facility, so that you can look at different parts of the spreadsheet at the same time. **£39.99**



Mailshot Plus

If you ever need to send out mailings or print labels, this program is for you. Animated labels appear on-screen as a continuous sheet, allowing you to scroll backwards and forwards. You can search, sort and detect duplicate labels, print side by side and much more. **£49.99**

DGBase

If you're looking for fast access to information, and the ability to create customised reports, then this relational database is for you (ST). **£49.99**



Day-By-Day

An excellent way to get organised. You'll be reminded of birthdays, meetings and appointments. It includes month/week/day planners and automatic reminders of overdue events. **£29.99**

Personal Tax Planner

Plan your own tax with ease. This simple program will calculate your income tax liability, allowing you to perform instant 'what-if' calculations and produce pertinent facts about your tax position. A professional version is also available for accountants and financial advisers. **£49.99**



E-Type

Transform your computer into a typewriter. Because text is printed instantly, you can line up your form, press return and space a few times to move to the correct place, and then start typing. Ideal for filling in forms and envelopes. **£39.99**

System 3

A suite of programs which perform all the basic functions for a small business. They may be used independently or integrated and include Cashflow Controller, Stock Control and Invoicing and Statements. **£59.99**



System 3e

Like System 3, but with extended capacity for customer accounts and stock items. **£79.99**

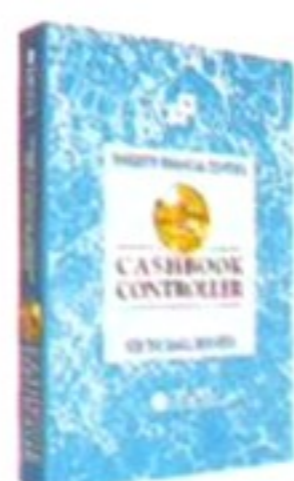

Cashbook Controller

Take the drudgery out of book keeping as this program will replace your cash and petty cash books. In addition to recording cash, bank and VAT transactions, you can enter credit sales and purchases, and for all these entries the program will automatically complete double entry routines, to ensure your records are always in balance. **£59.99**

Final Accounts

Using the information created with Cashbook Controller, this program will produce a complete set of accounts, including Trial Balance, Trading and Profit and Loss Account, Balance Sheet, as well as useful accounting ratios. **£39.99**



Cashbook Combo

A money-saving combination pack containing Cashbook Controller and Final Accounts. **£79.99**



Wordworth®

The graphical nature of Wordworth makes producing documents faster and easier. With the enhanced printing fonts, Collins Spelling Checker and Thesaurus, no other word processor comes close (Amiga). **£129.99**

The Digita range is available for Commodore Amiga, Atari ST and IBM PC unless stated otherwise, and every program comes with a seven day money-back guarantee.

The only way to really appreciate Digita software is to use it. Phone 0395 270273 for more information, or write to Digita, FREEPOST, Exmouth EX8 2YZ. All prices include VAT, postage and packaging.

DIGITA®
INTERNATIONAL
software that's right™

The Digita range is available to the trade through Columbus, Gem, HB Marketing, IBD, Lazer, Leisuresoft, Precision and SDL.

Sound and Music

GETTING IT

For creating music on the Amiga, there are two areas that need to be taken considered: the music sequence and the sounds used to play it. For the main part, music sequences tend to be written by users themselves, but there is another option. MIDI users can buy disks containing sequences of famous tunes, from modern hits to classic oldies. These are supplied in MIDI File Format, which can be read by most MIDI sequencer programs. Pretty much the best range of Amiga MIDI disks is available from Trycho Tunes (marketed by Zone, the UK distributors for Dr T's Software).

As for sounds, well this covers a much wider range of possibilities. Synth users can use patch editor programs (such as Dr T's *X-oR*) to load up pre-prepared disks of sounds and dump them onto your synth. Those without MIDI equipment will have to rely on Amiga samples. Sure, you can create sounds just using the Amiga's synthesis capabilities, but try creating vocals this way – you won't get far! Disks full of samples are available from Sample CD company Time and Space and Gajits (who brought us *Sequencer One*), although for the most part getting your own is a much more flexible system. A number of sampling packages are available (ranging from around £30 to over £200) and with a decent sampler, you can grab some interesting sounds from CDs, videos or the real world (using a microphone). Again, you can get extra help by buying CDs full of samples ready for you to grab – saving you the trouble of finding someone who's willing to set up a drum kit next to your Amiga to sample a snare drum!



If you don't have the confidence (or the back catalogue) to sample your own sounds, then sample disk series (such as this one from Time and Space) could be just the thing.

TWEAKING IT

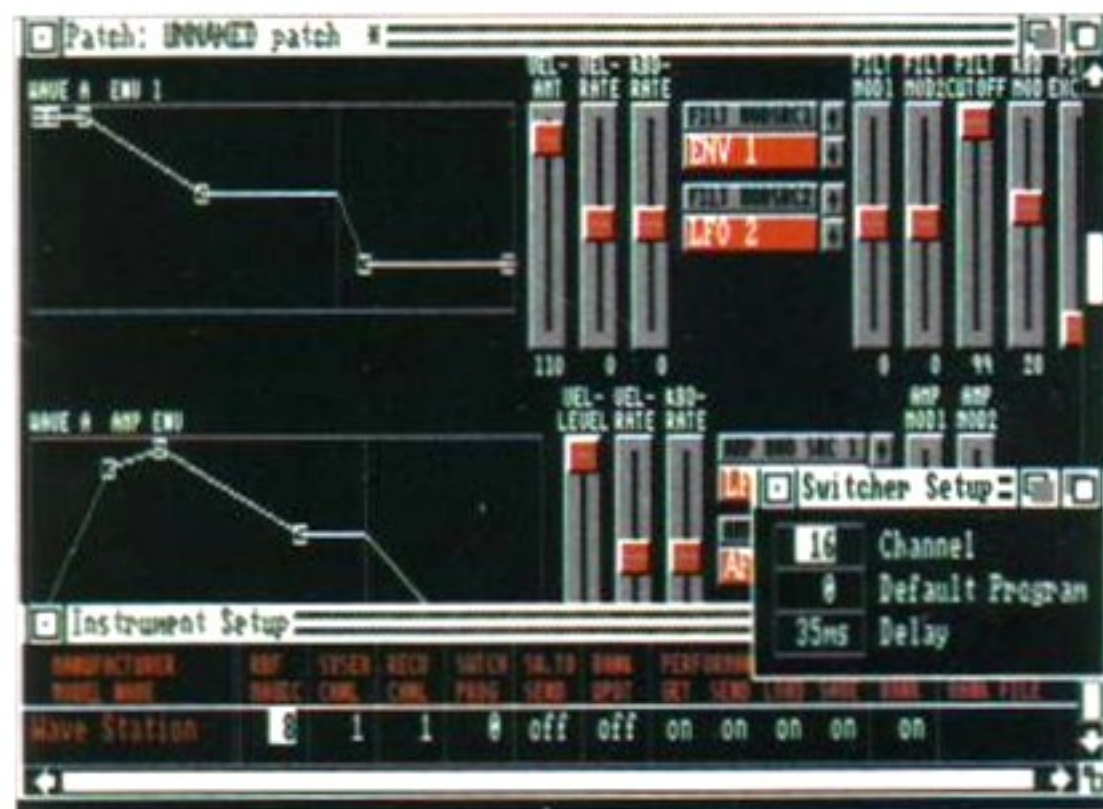

Users of MIDI equipment can upload, edit and store sounds to use on synths via their Amiga using a patch editor/librarian package such as Dr T's *X-oR*.

samples, you must make sure that the sound can be played in the required range, and that percussion sounds are correctly configured to play in the right place.

Another point to watch for is editing the sounds themselves to get them to fit a particular song. Drum loops supplied on sample disks may have to be edited slightly so that they loop properly and instrument sounds may have to be re-tuned so that everything plays in the correct key. *Audio Engineer Plus* (and *Audiomaster IV*) have special capabilities for changing the length of a sound without changing its pitch (and vice versa), which makes tuning instruments and arranging the timing of drum loops incredibly easy. In the main, samples supplied on disk will already be set up, requiring you to simply edit the right start, end and loop positions, but some more care is needed when sampling sounds yourself from different sources. Using sample CDs is fairly simple, since the sounds and loops will be separated individually and most of them will have been tuned already. In this case, all you'll have to do is record the sound you want, trim off any excess before and after the sound and set up a loop (if one is needed). For other sound sources (such as video) you will have to take more care when isolating and cutting out the required section of sound, but this comes with a little experience.

The easy ways in music are incredibly easy, because so much has been done for you...

PROBLEMS

Using sound and sequence files supplied ready-made on disk shouldn't cause too many problems, since they will be (for the most part) be saved in the right format for the majority of programs. Unfortunately, not all sequencers have the ability to load in Standard MIDI File Format sequences. The option to do this is usual called IMPORT MIDI (or LOAD MIDI FILE) and can access two types of sequence. File Format 0 reads sequences that have all the data on one track, whereas File Format 1 can recognise data on a number of tracks. Make sure that you select the right type for the file, otherwise the data could come out rather... well... oddly to say the least!



If you're serious about sampling on the Amiga, then the latest version of *Audio Engineer* is pretty much the bee's knees. It does cost a lot, but for your money you get the best editing facilities and sound quality possible.

To use Amiga samples, the main point to make sure of is that they are of the right format to fit the sequence. Most sequencers will accept IFF samples, but some programs need them saved into a specific format (see this month's Answer File on Page 203 for an explanation of various file formats). For example, *Sonix* has to have the waveform stored in multi-octave format before it will play over the full range of notes, as well as each sound having to be passed through the sound-editing page and resaved to get the sound shaping and editing controls working on an instrument. To save confusion (and aggravation later on), make sure that the correct sample format is set when you save a sound (including whether it should loop or not), so that you can load it into your sequencer. This involves careful studying of the sequencer instructions (and a little experimentation) so be patient!

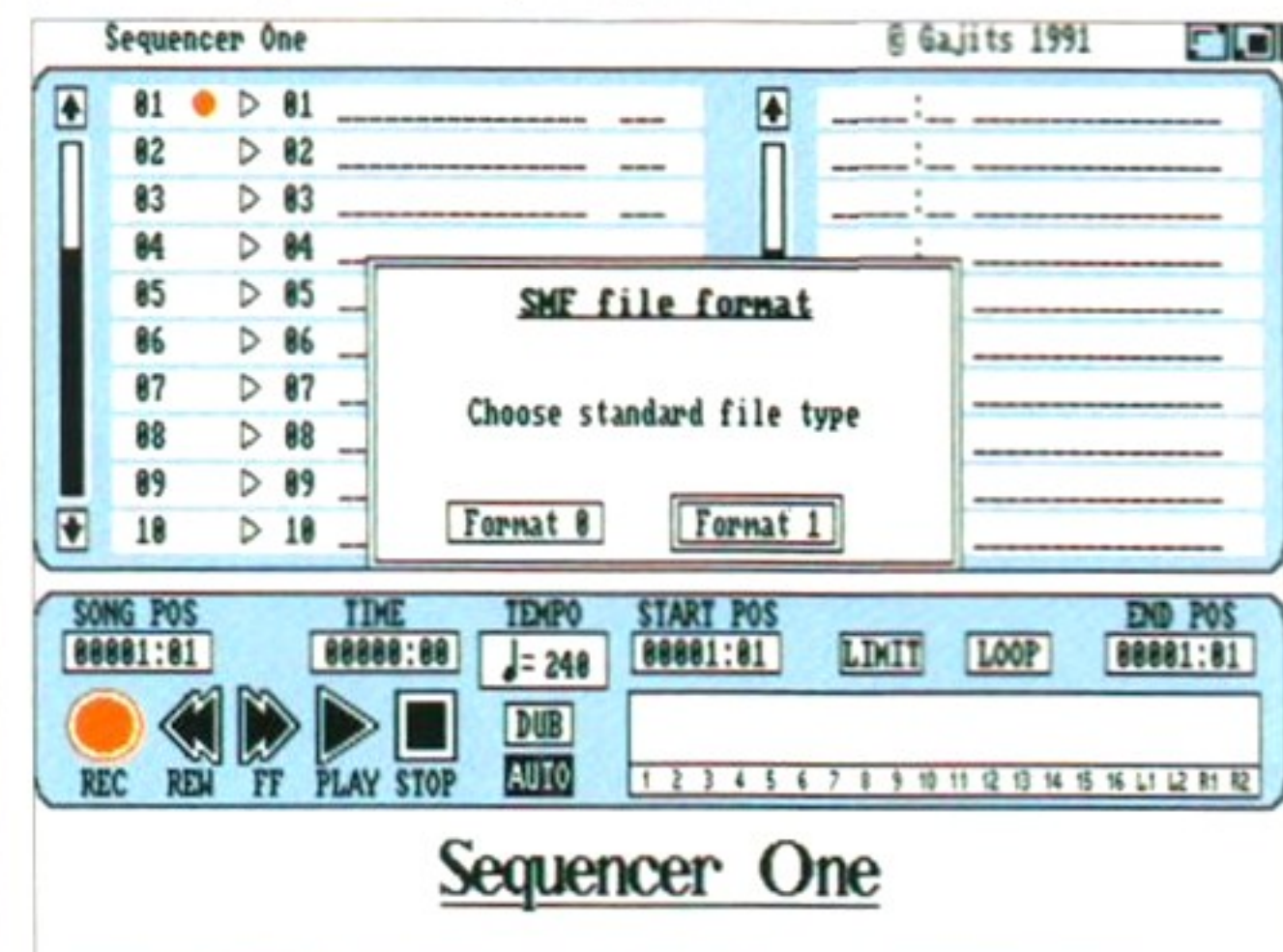

When loading pre-prepared sequences in Standard MIDI File Format, you have to make sure that you load in the correct file-type, otherwise things could go disastrously wrong with the tune!

Desktop Publishing

GETTING IT

Getting source materials is pretty easy for DTP. You're looking for extra fonts (the typefaces used to print letters on pages) and clip art (small pictures, similar to logos, that give the eye a rest). There are two types of each, called bitmapped and proportional.

Bitmapped fonts and clip art are by far the most common. Bitmaps are true computer graphics, consisting of little blocks of colour (pixels). Bitmapped computer graphics on the Amiga have a standard file format, called IFF. The trouble with bitmaps is, when you make them bigger in size, the pixels look bigger, and you end up with horrible angular text and blocky pictures. This effect is generally referred to as "the jaggies". They are not a problem when you use fonts and clip art that are



Here are a few sample proportional colour pictures from Genisoft. They are done with the *Professional Draw* program, and you cannot use them unless your DTP system can import proportional pictures from that program.

small on the page. Proportional fonts and clip art are made up of solid lines, arcs and angles. They are resolution independent, which means that it really doesn't matter what size you use them at because they always print free of "the jaggies". Although jaggie free print outs are much preferable to bitmaps, the range of what you can get is somewhat limited at the moment.

The best source for bitmap fonts is the Public Domain – many libraries have sets of fonts to use in DTP systems. However, if you want a certain font (for instance the widely used Times – you're looking at it now) then it's better to buy a commercial font pack. Contacts given at the end of the feature on Page 36.



Digit International's new *Wordworth* clip art disks are simple two-colour brushes, in IFF format so they would be "jaggy" at a large size – but they can be used with virtually any Amiga DTP or graphics program.

HOW TO MAKE THE MOST OF IT

DTP is quite similar to other areas, in that to make the most of material you have to keep a record of it. When you get a new font, print it out and keep a record of just what it looks like – the same goes for pictures. All right, so if you have a hard disk to store the all on then you can copy everything on to that. But plenty of people can't justify the cost, and when planning a page it's so much easier (and cheaper) to have a loose-leaf folder to ruffle through. It's simpler than depending on unlabelled floppy disks.

Bitmapped graphics are comprehensively covered in the graphics section, so check there. Proportional graphics come in three different formats which are not compatible – Aegis Draw (pretty rare in the UK), ProDraw clips and Encapsulated Post Script (usually just called EPSs). It isn't currently possible to transfer pictures between the three formats. So if your DTP program can't read in the picture, tough.



FontGrabber is an unusual editor, because it doesn't actually let you edit bitmap fonts! You can however load and save them as IFF pictures, for editing in a paint program like *Deluxe Paint*.

Fonts are somewhat more tricky. Any font you encounter should be copied to the fonts (or CGFonts, for Compugraphic Fonts) drawer on the disk you start up with. That's typically the DTP program you're using, although for people with a hard disk it's to the drawer fonts (or CGFonts) of the system directory, usually known as DH0:

The reason for this is simple to understand, although actually doing it requires a fair amount of CLI/Shell knowledge. Having the fonts on the disk you boot from means that they are available when you start work.

SOLVING PROBLEMS



Bulletin boards often have large amounts of PD clip art, fonts and sound samples for download – but 01 for Amiga also has a number of specialist font utilities for download too!

There are five different kinds of proportional font usable on Amiga DTP systems, although in the computing world there are several more variants. The main types are Agfa Compugraphic (the fonts on Workbench 2 are of this type), Adobe Postscript types 1 and 3, and Soft Logik's own *PageStream* fonts. The only difference between type 1 and 3 PostScript fonts is that type 1 are encrypted – however, Adobe recently released the specification, which means that it is now legal to create your own Adobe fonts.

Agfa Compugraphic fonts are machine specific, and cannot be

transferred between computer systems – you cannot use IBM PC CG fonts on the Amiga. Also, the Compugraphic format is a closed system, that is you cannot design your own fonts in this form without Agfa's permission. However, there is a utility on *Professional Page* called Font Manager, which can convert Adobe Postscript 1 fonts into Compugraphic form. The only alternative way of getting new CG Fonts is to buy them.

Postscript fonts are easier to work with, in that they do not change between machines. Mac Postscript fonts are especially easy to get going on the Amiga, but there are problems with IBM PC Postscript fonts. Specifically along with the actual font file you need another file with the same name but with .AFM (Adobe Font Metric, which contains the relative sizes and kerning of the font). IBM PCs use .PFM files for the measurement information, and so you need a PD utility called PFM2AFM. The only place I know of that has it is the 01 For Amiga bulletin board.

Beware of having a font collection that is too large. Fonts take up memory space, and are loaded in addition to the DTP program you are using. It slows down loading the main program, and when using fonts with paint packages it can take ages to read all the fonts in.

Active Cheating

HOW THE HARDWARE WORKS

A description of how cheating devices operate is in order. Sound samplers are the simplest to use. Simply connect a hi-fi or ghetto blaster headphone socket to the sampler, play your music and hit the record button on the sampling software. You can plug a microphone into the sampler, and record live sounds like splashes, thuds and similar effects.

Hand scanners are nearly as simple, although in our experience there is always some difficulty in setting them up. The Sharp JX range of colour scanners are a different kettle of fish, being easy to set up and having half-decent manuals and software that doesn't crash. Because scans grab large amounts of memory, it's not surprising that they are a bit cantankerous – but for reading in flat images to your Amiga, they are the best (and a must for DTP enthusiasts).

Video digitisers tend to be the worst offenders for getting decent results. This is down to the quality of videos that are used to grab pictures from. Commercial video releases are usually



One of the great bugbears of the Amiga is that, when you want to use your sampler/scanner/digitiser, you have to unplug your printer. And vice versa naturally.

degraded, to give an acceptable picture on a TV but a poor video signal for copying or digitising. The best results are obtained from material that you've recorded yourself, or from a video camera.

The quality of your source material is just as important for scanners and samplers. Try to sample from CDs, rather than tapes or vinyl.

Images to be scanned have to be perfectly flat, with high contrast – blurred, subtle images digitise badly. Don't blame the hardware if your source material is of naff quality!

RIPPERS

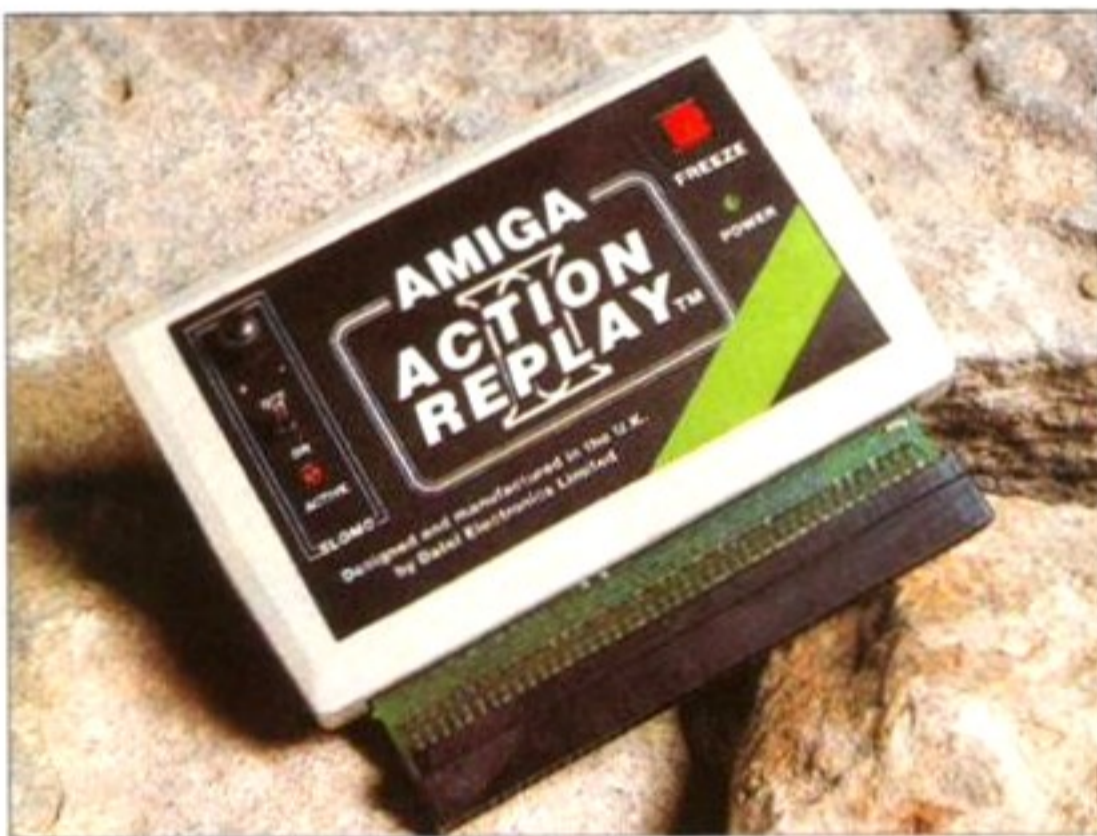

We still haven't managed to get our grubby mitts on a mark III Action Replay, but we were suitably impressed with the mark II – it really is the best ripper cartridge you can get for the Amiga.

One very important point about the Public Domain is its incestuous nature. Everybody copies everybody else's fonts, images and sounds, even if they are embedded within PD demos which are not written onto disks using the standard Workbench format. How is this possible?

The reason relies largely on the Amiga's specific design. Whenever you reset the machine, by pressing the Ctrl key and the two Amiga keys that are either side of the space-bar, the machine stops running the program in memory and sets itself up to load in a new disk.

However, it doesn't actually

clean out what is contained in its memory (RAM).

Within the PD are dozens of programs called rippers, which can look through memory and find the bits of sound and pictures that were running when the machine was reset. There are also hardware devices to do this, but I'll talk about them in a minute. Check out the *Hunter III* ripper on this Coverdisk to see exactly what they can do.

With the advent of sampler technology, few people really care about breach of copyright of sound. Images are a different case – if you use a ripper for this, you must change the material gained or get accused of blatant plagiarism. If everybody did it, then nothing original would ever be created again – but the present moderate use of rippers is probably beneficial in the long term.

The Datel Action Replay III is the ultimate in rippers. It's a hardware device that plugs into the left-hand side of an A500, or inside an A1500/A2000. You can scan memory for samples and grab pictures with it as software is running. Some software looks for it and won't run with it connected. Furthermore, a lot of software clears itself from memory during a reset, making it fool-proof against software rippers too. Cheating can be a real time waster occasionally...

SPENDING MONEY WISELY

Before you splash out on loads of hardware, get a list of priorities together and decide whether you have the resources to cope. For a sampler to be worthwhile you do need either a fairly good music collection or lots of live sounds to digitise. If you're into DTP then a scanner is a must, but if you're just beginning then buy some PD clip art first, to see what results you can expect.

Video digitisers are difficult to judge, because unless you have a video camera or a large stack of videos with decent signal quality, then they just aren't worth it. Also remember that only framegrabbers can digitise a picture from moving video, otherwise the frame has to be paused – how good is the freeze-frame on your video recorder?



If you're really, really strapped for cash, the Datel Digitizer II is the best budget buy at only £89.95. Available for A500, A1500/A2000 and Plus machines, you get reasonable results at a price that's right. Easy to use too.

On video cameras; Rombo's Vidi Amiga, Newtek's DigiView Gold and Datel's digitiser work quite well with mono (black-and-white) video cameras, using a set of colour filters. However, you'll need a tripod as well, to hold the camera steady when swapping between filters, and the subject image has to be completely still.

The best resources you can have are some local friends who share the same interests. If your mate's got a decent video camera, and you buy a digitiser, then perhaps you can develop a useful digitising system without spending an arm and a leg. PD swapping becomes a possibility – you don't need to go to a library if you know someone who already has a copy of a PD disk!



A hand scanner will give you the best raw material to start work on. OK, so most people can only afford a black-and-white one (if that) – but it's easier to get good results than with a digitiser.

CALLERS WELCOME AT OUR BRANCHES OPEN 9-5.30, MONDAY TO SATURDAY

PRICES SLASHED!!!
AMIGAS FROM

WANT MORE GAMES OR OTHER EXTRAS?
JUST ASK & WE GUARANTEE TO BEAT THE COMPETITION WITH THE BEST PACK AT THE BEST PRICE!

ST ALBANS SUNDAYS
10.00AM - 4.30PM

Hobbyte

COMPUTING ESTABLISHED 8 YEARS

10 MARKET PLACE ST. ALBANS
HERTS AL3 5DG TEL (0727) 56005/41396
THE GALLERY ARNDALE CENTRE LUTON,
BEDS LU1 2PG TEL (0582) 457195/411281

HOW TO USE THIS AD
For the first time ever, you can choose your own Amiga and software combination, and still benefit from the huge savings only available from package deals.
Want an A500 with 1500 software? No problem!
Like an A1500 without games? It's up to you!
All we ask is that you choose at least 1 software pack when you order your hardware (optional on CDTV or A3000)

AMIGA 500 1.3
Full UK spec., inc. mouse, power supply, all leads & manuals, etc.

	ALONE	WITH MONITOR
512K	279.00	478.00
1MB	299.00	498.00

AMIGA 3000
25MHZ, 100MB HD, 4MB Fast RAM, 2MB chip RAM

- SCALA • Deluxe Paint IV • Amigavision

ALONE	3289.00
WITH PHILIPS 7CM 3279	3539.00

AMIGA 600
1MB, WB 2.05, 3.5 FD + Smart Card Interface, with DeluxePaint III

A600	EPOA
A600 HD	EPOA

STARTER PACK I

	VALUE/RRP
• 10 Blank Discs + 80 capacity lockable disc box	26.98
• Mouse Mat	4.99
• Virus Killer Disk	4.99
• DPaint III or Home Accounts	79.99
TOTAL VALUE	116.95
WITH AMIGA/CDTV SEPARATELY	17.99 / 24.99

STARTER PACK II

	MAX VALUE/RRP
• Astra 10 games pack or 1/2MB RAM exp (1.3)	229.78
• G.F.A. Basic	50.00
• Photon Paint II or Back to the Future II (1.3)	89.95
• Holiday Accommodation*	
TOTAL VALUE	369.73
WITH AMIGA/CDTV SEPARATELY	17.99 / 34.99

*While stocks last, entitles 2 people to stay up to 16 nights in over 250 hotels in Great Britain, S.Ireland and France. All you have to pay for is breakfast and dinner.

NO OTHER DEALER CAN BEAT OUR CREDENTIALS

- 8+ years experience in Commodore product and here to stay
- Commodore trained staff are friendly and helpful and are parents, multimedia, educational, games, programming or technical specialists (usually more than one!)
- Open 9-6 pm Monday to Saturday and 10.00 am to 4.30 pm Sundays for convenient shopping.
- Callers welcome for advice and demonstration at our 1600+ sq ft High St, Town Centre branches
- Next day delivery for most orders received by 5 pm; express 7 am-9 am and Saturday services available
- Hardware carefully handled and delivered safely and reliably by caged, insured, top name courier service
- Free 30 day, next day courier collection and delivery of NEW replacement.
- Hotline support and in-house engineers
- Extended warranty available on many products
- Upgrade and trade in offers to keep you up to date
- Exceptional after sales service

COMMODORE PREMIER DEALER
Hobbyte proudly announce this highest CBM accolade, awarded to only the top few dozen CBM dealers offering the best in expertise and support. All Amigas full UK versions.

AMIGA 500 PLUS
Full UK spec., inc. mouse, power supply, leads & manuals, etc. inc. updated Agnus & Denise chips for better screen resolution to 1280x512, Kickstart & Workbench 2.04, expandable to 2MB CHIP memory & battery clock

	ALONE	WITH MONITOR
1MB	309.00	509.00
2MB	349.00	549.00

Zydec external drive with on/off & daisy chain port **ADD 48.00**
PC880B external drive with built-in anti-click & back-up device **ADD 68.00**

CARTOON CLASSICS GAMES PACK EXTRA (1MB REQUIRED)

	VALUE/RRP
• Cartoon Classics Games: Lemmings	25.99
The Simpsons	24.99
Captain Planet	25.99
• Deluxe Paint III with animation	79.99
• 3 Disc Home Pack including Word Processor, Spreadsheet, Database or PD Games compilation	9.99
TOTAL VALUE	161.96
WITH AMIGA/CDTV SEPARATELY	15.99 / 34.99

1500 PACK (CAN BE USED WITH A500, 1MB AND A500+)

	VALUE/RRP	
• The Works Platinum, word processor, spreadsheet, database	169.95	
• Deluxe Paint III with animation	79.99	
• Get the most out of your Amiga book	9.95	
• Hobbyte 50 Programme PD Greats Pack II	39.95	
EITHER	OR	
• Sim City	• Puzznic	24.99
• Populous	• Toki	24.99
• Their Finest Hour	• Digital Home Accounts	29.99
• Battlechess	• Elf	29.99
TOTAL VALUE	424.79	
WITH AMIGA/CDTV SEPARATELY	49.99 / 69.99	

SPECIAL: Also with Cartoon Classics Games ADD 12.99

WHAT THE CUSTOMERS SAY

... "extremely courteous and rapid response to my problem" ... "I will not hesitate to recommend you to my colleagues."
Dr Darrel Maddy - Slough

"Thank you for dealing so promptly with my requests." ... "I was reluctant about ordering my computer mail order. However I have been very pleased with my dealings with Hobbyte - you are to be commended for your customer service."
Trevor Patterson - Bangor

"We have dealt with many of the leading computer suppliers, in the past, but the service you provided was second to none."
E W Bailey - Preston

... "Thank you for everyone's good service" ... "it arrived at 7.20am the next morning."
David J Thomas - Wolverhampton

"I was very impressed with the service I received in the first instance, I really appreciated how quickly you managed to get the printer despatched from your Luton branch for me."
J S Cozadinos - Amersham

AMIGA 1500/2000
Full UK spec. with 1MB RAM, mouse, expansion as 2000, leads, manuals. New including Kickstart & Workbench 2.04. Hard disc configuration inc. the high performance GVP II controller card, EXPANDABLE TO 8MB. Fast reliable 52MB + 105MB Quantum Drives are used.

	ALONE	WITH 8833	WITH 7CM + FFXFER
Dual Drive	495.00	695.00	859.00
DD+GVP+20MB HD	699.00	899.00	1065.00
DD+GVP+52MB HD	785.00	985.00	1149.00
DD+GVP+105MB HD	925.00	1125.00	1289.00

Per extra 2MB fitted to GVP **ADD 60.00**

CDTV
The ultimate CD interactive multi media machine with an Amiga inside!

- CDTV with CD ROM drive
- Hutchinsons Encyclopaedia CD
- Lemmings CD
- Welcome CD + tutorial
- Disc Caddy
- Remote control unit

ALONE	439.99
--------------	--------

ALSO: With keyboard and black matching disc drive to allow access to whole range of Amiga disc based software **549.00**
SPECIAL: Also with up to £90 worth of CD titles of your choice! **ADD 60.00**

THE HOT LOT PACK (1MB REQUIRED)

	VALUE/RRP
• Cartoon Classics Games: Lemmings	25.99
The Simpsons	24.99
Captain Planet	25.99
• Deluxe Paint III with animation	79.99
• 10 GREAT individually packaged games, previous RRP's up to 39.99 each, phone to choose from current list, or leave it to us! Children's games available.	269.82
• 50 Programme Hobbyte PD Great Packs II	39.99
• Dust Cover + mouse mat	9.98
• 10 Blank Discs + 80 Capacity Disc Box	26.98
• Microswitch turbo joystick	9.99
TOTAL VALUE	513.72
WITH AMIGA SEPARATELY	59.99 / 79.99

SPECIAL: ALSO 10 extra great games ADD 25.00

PROFESSIONAL FAMILY PACK (1MB REQUIRED)

	VALUE/RRP
• Cartoon Classics Games: Lemmings	25.99
The Simpsons	24.99
Captain Planet	25.99
• Deluxe Paint III with animation	79.99
• The Works Platinum Word Processor, Spreadsheet and Database	169.99
• Their Finest Hour, Flight Simulator	29.99
OR Back to the Future and Postman Pat (1.3 only)	
OR Digital Home Accounts	
• Virus Killer Disk	4.99
• 50 Programme Hobbyte PD Greats Pack II	39.99
• Hobbyte Infant, Junior (specify) or Secondary Educational Pack	19.99
• 10 Blank Discs + 80 Capacity lockable disc box	26.98
• Mouse Mat + Dust Cover	9.98
• Turbo Microswitch Joystick	9.99
TOTAL VALUE	468.86
WITH AMIGA/CDTV SEPARATELY	79.99 / 99.99

SPECIAL: Also with Star LC 200 9 PIN Colour Printer and Starter Pack ADD 185.00
Also with Citizen 224+24 Pin Colour Printer and Starter Pack ADD 245.00

TRAMPY'S PACK 2-6 YEARS

AT LEAST 57 EDUCATIONAL/FUN FILLED GAMES!

	VALUE/RRP
The Shoe People - 6 colourful and entertaining games featuring Trampy and friends to encourage early number reading and pre-reading skills. With Shoe People music.	29.99
Shapes and Colours - Bobby the Clown entertains and lays down the foundation for maths and writing in 6 colourful animated games.	9.99
Fun School 2, 3 or 4 - the "Fun School" suite have won just about every award going. 5 or 6 wonderful animated games.	24.99
OR Picture Book: 4 colourful and amusing games from a company masterminded by the design and project manager of the award winning Fun School 2. With lower case keyboard overlay and "raspberry", crowd cheers and animal noises that will delight young children.	
Deluxe Paint II/Photon Point II or Elf or Puzznic	89.99
Hobbyte Infant Educational PD Pack, containing 10 fun while you learn games	19.99
Hobbyte 30 Easy Children's Games Pack	19.99
10 Blank Discs, Disc Box, Joystick, Mouse Mat	26.96
TOTAL VALUE	221.90
WITH AMIGA/CDTV SEPARATELY	49.99 69.99

ABSOLUTE BEGINNERS PACK 3-9 YEARS

	VALUE/RRP
Fun School 2, under 6 years, 6-8 years or 8+ years	19.99
Fun School 3 or 4, specify, under 5 years, 5 to 7 years or 7+ years.	
12 stunning UK educational games with beautiful pictures, exciting animation and music that helps to develop number, word and other skills. Up to 6 skill levels. Conform to National Curriculum requirements.	24.99
Postman Pat (1.3 only), OR Edd the Duck (7+ years) OR Matched Pairs OR Blinky's Scary School	14.99
Hobbyte Infant or Junior (specify) Educational Pack, featuring up to 12 "Learn while you play" games	19.99
Hobbyte 30 Easy Children's Games, 10 pack disc including Train Set and other top entertaining PD titles	19.99
10 Blank Discs	6.99
Joystick	9.99
Deluxe Paint II/Photon Point II or Elf or Puzznic	89.99
TOTAL VALUE	206.92
WITH AMIGA/CDTV SEPARATELY	49.99 69.99
SPECIAL: Also with Cartoon Classics Games and Dpaint III instead of Dpaint II/Photon Point II (1MB req.)	
VALUE	80.00
ADD	14.99

THOMAS'S PACK 3-9 YEARS

	VALUE/RRP
Thomas the Tank Engine's Fun with Words 6 separate easy to use learning programmes with animation and sound, selectable lower or upper case letters and 4 levels. Reward sequences feature your child's name. Includes free word and picture sight cards.	23.99
Fun School 2, 3 or 4 - the "Fun School" suite have won just about every award going. 5 or 6 wonderful animated games.	24.99
OR Picture Book: 4 colourful and amusing games from a company masterminded by the design and project manager of the award winning Fun School 2. With lower case keyboard overlay and "raspberry", crowd cheers and animal noises that will delight young children.	24.99
Postman Pat, Snap, Snakes and Ladders and Ludo (1.3 only) OR Edd the Duck OR Matched Pairs OR Blinky's Scary School.	19.99
Deluxe Paint II/Photon Point II or Elf or Puzznic	89.99
Hobbyte Junior Educational PD Pack, containing 10 fun while you learn games.	19.99
Hobbyte 30 Easy Children's Games Pack	19.99
10 Blank Discs, Disc Box, Joystick, Mouse Mat	26.96
TOTAL VALUE	225.90
WITH AMIGA/CDTV SEPARATELY	49.99 69.99
SPECIAL: Also with Cartoon Classics Games and Dpaint III instead of Dpaint II/Photon Point II (1MB req.)	
VALUE	80.00
ADD	14.99

GOLDBLOCKS PACK 5-11 YEARS

	VALUE/RRP
The Three Bears - A colourful educational and entertaining adventure loosely based on the traditional story. (Improves reading skills and develops imaginative and logical thought)	22.95
Money Matters - Four graphically brilliant and educationally sound games with coins keyboard overlay, top reviews	24.99
Postman Pat (1.3 only), OR Edd the Duck (7+ years) OR Matched Pairs OR Blinky's Scary School	14.99
Hobbyte Infant or Junior (specify) Educational Pack, featuring up to 12 "Learn while you play" games	19.99
Hobbyte 30 Easy Children's Games, 10 pack disc including Train Set and other top entertaining PD titles	19.99
10 Blank Discs	6.99
Joystick	9.99
Deluxe Paint II/Photon Point II or Elf or Puzznic	89.99
Mouse mat	
TOTAL VALUE	224.86
WITH AMIGA/CDTV SEPARATELY	49.99 69.99

FAMOUS FIVE PACK 7-15 YEARS

	VALUE/RRP
Join Enid Blyton's Famous Five to solve the mystery of Treasure Island in this educational interactive adventure	24.99
Spellbound - 5 exciting arcade type games to develop logic, memory and spelling skills or any Fun School	25.99
Target maths, suite of 4 fun programmes aimed at specific National Curriculum targets or Maths Adventure: This adventure through time allows pupils to revise and check their progress in National Curriculum maths	25.99
Sim City - Educational game award winner and Populous OR Elf - travel as Cornelius the Elf and Puzznic - addictive puzzle game	49.98
Hobbyte Junior or Secondary Educational PD Pack, featuring up to 12 "Learn while you play" games	19.99
Hobbyte 50 programme PD Greats II Pack	39.99
Joystick	9.99
TOTAL VALUE	196.92
WITH AMIGA/CDTV SEPARATELY	59.99 79.99
SPECIAL: Also with 10 great individually packaged games RRP's up to £39.99, phone to choose from current list, or leave it to us! Children's games available plus Joystick	
VALUE	£279.81
ADD	£34.99

CLASS OF THE 90'S FIRST STEPS (1MB REQUIRED)

	VALUE/RRP
Pro Write 2.5	99.99
Deluxe Paint II or Photon Point II	89.99
Deluxe Print II - Create labels, cards, posters etc	49.99
Infofile Database	49.99
Music - Mouse music creator using mouse	29.95
Logo + Talking Turtle - Educational prog. languages	49.95
Let's spell at home - fun learning	19.95
BBC Emulator	39.95
Resource File	
Intro Video	4.99
Hobbyte 30 Easy Children's Games, 10 disc pack inc. Train Set and other top entertaining PD titles	19.99
Hobbyte Junior or Secondary Educational pack featuring up to 12 "Learn while you play" games	19.99
Joystick, mouse mat, 10 blank discs	21.97
TOTAL VALUE	496.70
WITH AMIGA/CDTV SEPARATELY	139.99 179.99
SPECIAL: Also with Star LC 200 9 PIN Colour Printer and Starter Pack	
ADD	185.00
Also with Citizen 224+24 Pin Colour Printer and Starter Pack	
ADD	245.00

ACCESSORIES

Blitz virus protector + backup device for any external drive	23.99
A520 Modulator	26.99
A500 Deluxe control centre	44.99
Competition Pro Joystick	11.95
Competition Pro Star Joystick	13.95
CDTV Keyboard	44.95

FLOPPY DRIVES

New A570 CD-ROM Drive	POA
Zydec 3.5 external drive, daisychain + on/off	48.95
Cumana CAX 354 3.5 external drive, beige	52.99
CDTV external 3.5 drive, black	59.99
PC 880B with anti click + Blitz back up and virus protector	69.95
Dual drive as PC 880B	115.95

MONITORS/TVS/ACCESSORIES

CBM 1084/1085SDI monitor + leads	225.99
Philips 8833 MK II monitor and leads	219.99
Goldstar TV/Monitor, with remote control + leads black	188.99
CBM 1960 High res monitor + flicker fixer for 1500/2000	549.99
Tilt + swivel stand for Philips 8833	12.99
Philips 7CM3279 Hi-res SVGA .28dp for 3000 inc. tilt & swivel	259.99
As above, plus flicker fixer for A1500/2000	369.99

HARD DRIVES

New A570 CD ROM Drive	POA
New GVP 530 Drive	POA
A590 20MB HD	269.99
A590 20MB HD + 2MB	325.99
A590 52MB HD	399.99
A500 GVPII 52MB HD, exp to 8MB	358.99
A500 GVPII 10MB HD, exp to 8MB	525.99
A1500/2000 GVP II controller, exp to 8MB + Quantum 52MB HD	285.99
A1500/2000 GVP II cont., exp to 8MB + Quantum 105 MB HD	475.99
Per extra 2MB fitted to above	62.99

A500 TRADE-IN

Up to £175.00 trade-in allowance, extra for peripherals and accessories. Trade in your A500 for a brand new A600/A1500/2000/3000, CDTV or even a PC.

SCANNERS

Naksha 400 dpi 32 greyscale + Datascan software	87.99
Power Hand Scanner, 400 dpi, 64 greyscale, Powerscan software	97.99
Sharp JX100 A6 Scanner + scanlab software, supports 4096 cols, up to 18 bit	595.95
Sharp JX-300 A4 Scanner + s/w, up to 24 bit	POA

EXPANSION

A500 512K RAM exp + clock	21.99	CBM A501 the official	
1MB exp for A600	POA	512K RAM expansion	39.99
1.5 MB exp for A500	74.99	A500 plus 1MB upgrade	43.99

1.3 to Plus Upgrade. Chip fitting and board upgrade available, by our qualified engineers. POA

EMULATION

KCS Powerboard	188.99	AT Bridgeboard for	
GVP PC Emulator	265.99	1500/2000	329.99
AT Once	178.99	386 SX Bridgeboard for	
		1500/2000	429.99

DISCS

10 Blank DS/DD discs in box	6.99
50 Blank DS/DD discs	17.99
50 Blank DS/HD discs	27.99

NO DEPOSIT CREDIT FACILITIES

Credit terms at 34.8% APR (variable) can be arranged for purchases over £150, subject to status. Competitive leasing schemes are also available for businesses, including sole traders and partnerships. Just telephone for written details and application form.

PRINTERS

	WITH STARTER PACK	ALONE	WITH STARTER PACK
Citizen 120+D	112.95		
Star LC20	124.95		
Star LC200 col	172.95		
Citizen Swift 9	178.95		
Star LC 24-10	178.95		
Star LC 24-200	216.95		
Star LC 24-200 col	256.95		
Citizen 124D	176.95		
Citizen 224	211.95		
Citizen 224+col	236.95		
Citizen Swift 24e	246.95		
Citizen Swift 24e col	266.95		
Star XB 24/200	376.95		
Star XB 24/250	456.95		
HP Deskjet	346.95		
HP Deskjet col	576.95		
HP Paintjet	526.95		
BJ10e Bubblejet port.	226.95		

STARTER PACK: 500 Sheets A4 or continuous paper, Amiga to printer lead & Universal Printer Stand

ORDERING: TELESALES NO: (0727) 56005

Next day delivery for credit card orders placed before 4.30pm subject to availability. Alternatively send cheque, postal order, bankers draft or official order (PLCs, Education and Government bodies only) to; Dept. AUI, Hobbyte Computer Centre, 10 Market Place, St. Albans, Herts AL3 5DG. Please allow 7 working days for cheque clearance. Subject to availability, despatch is normally within 24 hours of receipt of cleared payment. Prices are correct at time of going to press, however, we are sometimes forced to change them, either up or down. Please check before ordering.

DELIVERY CHARGES: UK MAINLAND (NOT HIGHLANDS)
Small consumables & software items Despatched by post, please check charges when ordering
Other items, except lasers Next day courier service, £10 per box
Offshore and Highlands Normal rate plus £20 + VAT per box
IN ADDITION WE OFFER THE FOLLOWING EXPRESS SERVICES:
Saturday deliveries Normal rate plus £15 + VAT per box
7am to 9am next day Normal rate plus £10 + VAT per box
Am next day Normal rate plus £5 + VAT per box

Amiga prices, except where stated are inc. VAT. E.&O.E.

• PHILIPS APPOINTED DEALER • HP AUTHORISED DEALER • CITIZEN DEALER PLUS •

TELE-ORDER (0727) 56005

Contacts

Audio Engineer Plus – £204.30

HB Marketing, 0753 686000

Audiomaster IV – £75

HB Marketing, 0753 686000

Stereo Master – £29.99

Amiga Format Mail Order (see page 182)

Studio 16 – NA

Sunrise Industries. No UK distributor at time of press

Technosound Turbo – £29.95

Amiga Format Mail Order (see Page 182)

Sequencer One Samples – £9.95 each £39.95 full set

Amiga Format Mail Order (see Page 184)

Zero-G Data File CD – £49.95 per CD

Zero-G Data File Amiga – £29.95

Time and Space, 0442 870681

Trycho Tunes – £7.95 per song

Zone Distribution, 071-738 5444

Dr T's X-oR – £219

Zone Distribution, 071-738 5444

Action Replay III/A500 Video Digitiser II

Datel Electronics, 0782 744707

Pandaal Hand Scanners

Pandaal Ltd, 0234 843355

Sharp JX100/JX300 Colour Scanners

Sharp Electronics, 0345 125387 (Dealers)
061-205 2454 (End User Support)

Vidi RGB/Complete Colour Solution

Rombo Ltd, 0506 414631

Marcam PAL Framegrabber 2

Marcam Ltd, 0604 790466

Genisoft ProDraw Clip Art/FontGrabber/DigiView Gold/Audio Engineer Plus

HB Marketing, 0753 686000

Professional Colour Clip Art

Nik Williams Broadcast Pictureware, 0792 470503

Professional 24 Bit Systems

Amiga Centre Scotland, 089 687583

Professional Amiga DTP Advice

The DTP Bureau, 0602 420528

Public Domain Bulletin Board

01 For Amiga, 071-377 1358, 8 Data, 1 Stop, No Parity, All baud rates (Don't call without a modem!)

Public Domain Clipart and Fonts

Too many people to mention here – check out the adverts around PD Update on Page 159.

Public Domain demos and Rippers

The best suppliers are 17 Bit Software, 0924 366982

Real Things AnimBrushes

RGB Studios, 0825 732666

Wordworth IFF Clip Art

Budget Scanners



Without a doubt, the Pandaal scanner pictured here is the best of the black-and-white type of scanner.

is that all hand scanners are black-and-white only – you cannot scan colour images with them. You can, however, get 16 shades of grey, so you can use colour images to scan from. Just don't expect the images you see on screen to be in anything other than black and white!

There are a few makes of hand scanners, from manufacturers like Datel and Golden Image, but the best one you can buy without a doubt is the PanDAAL. Scans look crisp and the moire patterns you sometimes get with the other makes are much reduced.

Of course, the PanDAAL scanner does cost more than the others, and if you're really squeezed for cash then the Datel one will do. But Pandaal's offering was clearly the best in the last round up of scanners that we did (Issues 22 and 23), and the fact is that PanDAAL are in the final stages of releasing a new, even better version that should settle the matter once and for all.

One very important point to remember

Budget Samplers



The grand daddy of sound samplers, Master Sound, is the same basic design as more modern types.

a slicker, more modern appearance and a whole host of special effects to mess around with.

If you do plump for a cheaper sampling package, it shouldn't limit you too much in the long term. You can always upgrade your software to something like Audiomaster (currently at version four), which is a version of the Audio Engineer Plus program which can be used on a number of different sampler types.

In the lower end of the sampler market, there are a few of options available, but for ease of use and decent results, you need to choose carefully. The two most frequently used (and most impressive at the price) are New Dimensions' Technosound Turbo and Microdeal's successor to Master Sound, Stereo Master. Both of these systems cost less than £40 and give pretty good results for the money. Technosound is aimed more towards the beginner, with a friendly colourful display and all manner of helpful hints and tutorials to get you going. Stereo Master is more for those who have some experience with samples, presenting the user with a

Budget Digitisers



You get the best quality pictures with DigiView Gold, unless you want to splash out loadsamoney.

The best one to get is Rombo's Vidi RGB, which is designed to work with Vidi Amiga and the VidiChrome colour software, but will work with other types. However, if you are using a digitiser in this manner, you must be grabbing from an unchanging video signal, either a video recorder on pause or a colour video camera pointing at an unmoving subject. The quality of pictures that you get depends roughly on how expensive your video equipment is.

There are three digitisers to look out for. The Datel Video Digitiser II is the cheapest, and provides quite acceptable results. Vidi Amiga has more comprehensive software, and can easily be setup to record a set of images in quick succession. Newtek's DigiView Gold produces the best pictures (the software routines for decoding video must have been written by a genius). However, it is much slower at producing pictures.

Whichever you buy, none of them will grab colour images. You can buy a separate box called an RGB splitter. This splits a colour video signal into the different red, green and blue parts.

High-end Scanners



The Sharp JX100 is the best colour scanner which can be fitted to any Amiga. Bit small though.

When it comes to scanning in colour, you are at present limited to the Sharp JX range of scanners. A shame, but the quality you get from them is truly excellent. The JX100 will work with any Amiga, although at least 4Mbs of RAM is recommended – colour scans take up lots of memory. The driver software for the Sharp scanners was written by ASDG, the same people who produced *Art Department*, and is very simple to use.

However, the JX100 can only scan images of A5 size, which is a bit on the small size. To get A4 size, you need to get Professional Scan Lab II, which can only be fitted to A1500s, A2000s or A3000s.

ProScanLab II costs in the region of £3,000, but you do get a Sharp JX300 flat-bed scanner thrown in for that price. This can scan at 24-bit colour resolution, giving a palette of 16 million colours. 4 or 5Mbs of RAM is recommended, and even then you're pushing it a bit. Currently that's the limit for Amiga scanning – although Epson are releasing something similar.

High-end Samplers



The top end of the Amiga samplers market is pretty much dominated by *Audio Engineer Plus*.

At the top end of the Amiga samplers market, there is only really one option – Ramscan's *Audio Engineer Plus*. Weighing in at just over £200, this package contains the best sampling hardware available (with individual input gain controls, printer pass through and superb sampling quality) along with software that boasts some near-professional features, such as four times oversampling, an adjustable digital filter and time-stretch and pitch conversion capabilities. The system is extremely easy to use, but offers superb samples for you to use in music packages or your own programs.

For 2000 users that want to make use of some serious sampling applications, Sunrize's Studio 16 is a rather impressive system. The program is designed to make use of a special digitising board that fits inside the 2000, which brings the Amiga's sound capabilities up to full 16-bit digital audio. The system can be triggered via MIDI and effectively turns your 2000 into a dedicated sampler (something like Akai's S950 and S1000 studio samplers).

High-end Digitisers



The Marcam frame grabber has manual controls, excellent software, but a price tag of £500.

If you want to grab colour video images from a moving video, then a framegrabber is what you want. The best all round variant is the Marcam, which is a European licence of the popular American Progressive Peripherals and Software product.

The Marcam is very clever, in that you can use it with any 1Mb Amiga, and you can actually view the video you are grabbing from as it is playing. This is achieved by a couple of cables hooked up between your computer, the framegrabber and your monitor.

There is a better framegrabber available now, called *VLab* (it's reviewed on Page 130). However, the trouble with *VLab* is that it needs

Kickstart 2 and will only work in an A1500, A2000 or A3000. It's much easier to setup and use than the Marcam effort, although the preview option isn't so good. Still, it's results that count, and *VLab* certainly packs a punch in this area.

If you're video professional working with Y/C systems, then the people to speak to are Amiga Centre Scotland. There is a choice of Y/C digitisers. They're usually built into 24 video cards.

Getting Organised

First a public service announcement – this phrase originates with the armed forces, so it's a bit on the rude side – people of a gentle disposition should skip to the next paragraph. "The Rule of Ps" are the wisest advice for any undertaking; Prior Planning Prevents Piss Poor Performance.

Hopefully, you should have some good ideas by now about how to improve what you do with your Amiga. But before you start anything, always have a plan on paper – not just a few scribbled notes. Revise your plans, thinking around problems before they happen. Think long term as well as short term, building up a number of finished projects to show to prospective employers.

In the past, the Amiga has been pretty much ignored (rather unfairly, might we add) in the professional field (whether in music, graphics and animation or DTP), in favour of machines such as the DTP standard Apple Macintosh, the animation favoured PC and the music-studio stalwart the Atari ST.

However, these days things are starting to change. The relatively low cost of the Amiga, along with its wide user base and extensive range of extremely impressive applications is starting to attract notice from all walks of life. Graphics and animation are taking off thanks to the advent of True-Colour cards and easy-to-use art systems, music software is appearing to beat the ST (not to mention bands like Urban Shakedown creating entire singles using only the Amiga's sound capabilities) and friendly (yet powerful) DTP systems are making it possible for anyone to be a publisher.

The next few years (judging by *Amiga Format*'s performance and Commodore's sales figures) are going to see a helluva lot of people who can use the Amiga well, as well as a wider range of designing, animating and composing systems appearing to strengthen the Amiga's position as a powerful all-round machine. Hopefully this will result in Amigas being a commonplace sight, not just as a prop on the telly and in films but on the street, in shops – throughout normal life.

The Nineties will see an explosion in what the experts call "Multimedia". These are computer-based information systems, displaying images, playing sounds and displaying normal text. This is the Amiga's natural area, what it does the best. But for it to be a major player in this area will take the artists, designers and writers who can use the machine – and that's where you come in. Multimedia won't depend so much on programmers, but on creative types who are happy working with computers.

Who do you think will design the Multimedia CDs for CDTV and the CD-ROM drive? You will! What you must remember is that there are no experts in this area, no ready source of experienced talent. It will take new people with new skills to make it possible – people like you, maybe. After all, everyone has to start somewhere, and seeing as you're reading *Amiga Format*, you already have the nexus of a potentially powerful system for almost anything you could possibly create.

Hopefully, this feature has given you some idea as to how you can get started in creating some wonderful artistic creations on your machine, whether you're making letterheads or putting together a magazine, creating a slideshow or creating a video-ready animation, writing a piece of demo music or cutting a hit album, there is a wide range of devices, programs and sources for you to pillage to achieve your goals. The existence of ready-made files for you to use means that even the most hesitant beginner can be given a helping hand into any creative field on the Amiga, so why not give it a go for yourself?

Right, we've told you where to get the tools and given you an idea of where to go for some files to get you started. You've got the machine, the gadgets are available, the opportunity for fresh talent is there and the real world is ready for the taking. All it takes now is a little bit of practice and you could end up a household name (well... in time, maybe). So just go out there and do it! You could find fame and fortune and have a lot of fun along the way!

Next month's *Sega Power* (the magazine with bags of Plymouth Argyle) makes hay while the sun shines in the six yard box! There are some wicked FREE earphones on the front too!

BRITAIN'S BEST-SELLING SEGA MAGAZINE!

SEGA POWER

NOT APPROVED BY SEGA UK!
JUNE 1992
ISSUE 31 £2.50

Er... quite remarkable! Tecmagik's Master System football game! Er, Brian...

179
MEGA DRIVE GAMES
REVIEWED & RATED!

168
MASTER SYSTEM GAMES
REVIEWED & RATED!

30
GAME GEAR GAMES
REVIEWED & RATED!

40
GAMES TIPPED IN OUR
14 PAGE TIP BONANZA!

HEAD IT IN!

European Club Soccer hits your Mega Drive!

FREE!
Crank up the volume with these **SEGA POWER EARPHONES**
Fully enjoy the stereo sound of your Mega Drive and Game Gear with these excellent earphones!

No stereo earphones?

Ask your newsagent!

SONIC VERSUS MARIO

Who's the best game character in the whole world?

WIN 4 season tickets to see Arsenal, Liverpool, Man Utd, Spurs...! PLUS 5 full soccer strips!

Future PUBLISHING
Your guarantee of value

06
9 4770961 271993

BRILLIANT
EARPHONES
FREE
WITH THE JUNE
ISSUE!

June issue on sale on Thursday 7 May. We've booked it to be sunny, so you'll get a tan on the way to the newsagents too.

Pukka!

POWER COMPUTING

GVP Series 2 HD (A500)



Up to 8MB Fast RAM on board

52QMB 0MB	£369	105QMB 0MB	£479
52QMB 2MB	£419	105QMB 2MB	£529
52QMB 4MB	£469	105QMB 4MB	£579
52QMB 8MB	£599	105QMB 8MB	£719

GVP A530 Turbo HD (A500)

40MHz 68030EC accelerator
Optional 68882 maths co-processor
Up to 8MB 32-bit Fast RAM on board
68882 Upgrade kit £239
52MB 0MB £729 105MB 0MB £869 240MB 0MB £1069

GVP Series 2 HD

Up to 8MB Simm RAM on board
Supports external SCSI devices
For A1500/A2000
Bare £199

52QMB 0MB	£279	105QMB 0MB	£479
52QMB 2MB	£339	105QMB 2MB	£539
52QMB 4MB	£399	105QMB 4MB	£599
52QMB 8MB	£469	105QMB 8MB	£749

GVP G-Force

68030 Accelerator board
68882 Maths co-processor
25MHz 1MB RAM £579
40MHz 4MB RAM £949
50MHz 4MB RAM £1349
Hard drive mount kit £35

GVP A2000 RAM Expansion

0MB £92 2MB £129 4MB £179 6MB £239 8MB £299

GVP

Sound Sampler

High quality 8-bit sampler
Sample up to 51,000 samples/sec
Works on any Amiga £55

Magneto Optical Hard Disk



New style case with built-in power supply
High power cooling fan
SCSI ID switch for instant ID switch
25-way & 50-way SCSI ports (one may used as thru'port)
Compatible with all major SCSI controllers
Up to 128MB on each removable cartridge
Compatible in speed with many hard disks
128MB HD (internal fitting) £999
128MB HD (external cased) £1199
128MB 3 1/2" optical cartridge £39.95 each
SCSI controller card for A1500/A2000 £199
Compatible with Amiga, PC, Mac. A SCSI controller is required on the Amiga and PC.

Progressive Peripherals 68040 Accelerator Board

25MHz Motorola 68040
Built-in maths co-processor
Expandable up to 32MB of RAM
Software compatible with 68000 processors
0MB RAM £1449 16MB RAM £2109
4MB RAM £1569 32MB RAM £2525
8MB RAM £1689

Nexus Hard Card

Up to 8MB RAM on board
For A1500/2000
Bare £199
52QMB 0MB £279 105QMB 0MB £479
52QMB 2MB £339 105QMB 2MB £539
52QMB 4MB £399 105QMB 4MB £599
52QMB 8MB £469 105QMB 8MB £749

Kickstart ROM Switch



The Power Kickstart ROM Switch fits into any A500 or A500+ and can be fitted with up to three Kickstart ROM's and can be enabled when you switch on your Amiga.
This gives you all the benefits of the new versions of Kickstart while still being able to use your old games and software.
Kickstart ROM switch (Bare) £17.95
Kickstart ROM switch with 2.04 £59.95

Chips

256K x 4DRAM £4.50 4MB x 8Simm £150
1MB x 1DRAM £3.95 1MB x 8Simm £30
8372 Fatter Agnus £39 1 x 4 Zip £19.95
A3000 Static column RAM £22
Simm 32 x 1MB-60 £65 (suitable for GVP A530)
Simm 32 x 4MB-60 £234 (suitable for GVP A530)
2.04 Kickstart (chip only) £39.95
2.04 Kickstart ROM chip, Workbench software
Install disk 2.04
Font disk & extras disk £99.95
With ROM share £115

Avideo 24

24-bit graphics for the A500
768 x 580 quality resolution
16.8 million colour frame buffer
Small easy to fit circuit board
Overlay Amiga graphics & animations
Fully genlockable
Runs on a standard A500 (1MB of chip RAM)
Comes with 24-bit paint package
Allows picture in picture £599 (includes TV Paint)

Rembrandt

24-bit colour
16 million colours
A1500/A2000 £1500

Bare SCSI Hard Drive

52 Quantum £199 105 Quantum £299

Send your order to Power Computing Ltd, Unit 8 Railton Road, Woburn Road Industrial Estate, Kempston, Bedford MK42 7PN
Ring your credit card order through on **0234 843388 (10 lines)** or Fax **0234 840234**. Technical helpline **0234 841882**

All prices include VAT, delivery and are subject to change. Specifications are subject to change without notice. Next day delivery £4.50 (U.K. mainland only), all trademarks acknowledged



MAIN SCREEN



THE SPECIAL EFFECTS CONTROL PANEL

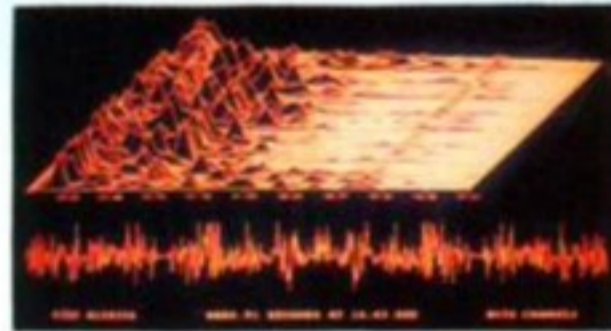

3D DISPLAY OF SAMPLE FREQUENCIES (FFT)



STEREO OSCILLOSCOPES



STEREO SPECTRUM ANALYZERS

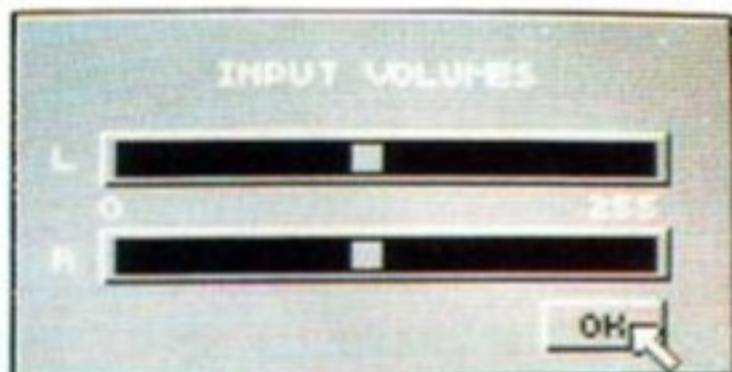
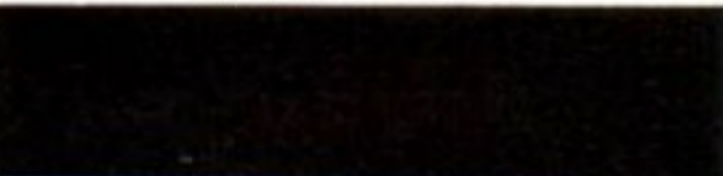

DIGITAL INPUT VOLUME CONTROL



© COPYRIGHT 1991
ALL RIGHTS RESERVED



ADVANCED MIDI AMIGA SAMPLER TWO

AMAS 2 for the AMIGA

Following in the footsteps of one of the best sound samplers ever produced comes the innovative AMAS 2. With even more features than the original Amas which was featured in the Paula Abdul music video "Cold Hearted" this package is high in professionalism but low in price. Amas 2's new digital input controls allow you to adjust the input level of your sounds from the software suite by precise adjustment rather than by messy analogue controls as you would find on other samplers. By purchasing this state of the art product which combines a quality sampler with the expertise of over 10 years of software programming, you are purchasing a top quality product in the knowledge that it is not only compatible with existing Microdeal products but will also be with future ones.

What is AMAS 2

Amas 2 is a high quality sound sampler and midi interface for the Amiga range of computers. The sampler cartridge in its stylish wedge shaped box enclosed in this package plugs into the printer and serial ports at the rear of the computer and allows you to analyze the sounds coming in, change the way they sound by using the real time special effects or record sounds all using devices such as Personal Cassette players, Compact Disc Players etc. Once in the computer AMAS 2's unique editor will enable you to edit the sound in practically any way you can imagine and even add some special effects to the sounds. Once you have the sound sample how you want it, you may incorporate it into your own programs or use Amas 2's unique MIDI playback controls for replaying the sample from a MIDI keyboard or similar.

The Sampling Software

- Every feature you would expect to find in a professional editing suite including:
- Real time record/play ghost markers
 - Cut or Delete selected sample area
 - Mix sample with full or half volume
 - Shrink in by 25%/50%/75% by drag or wipe
 - Fade in/out with selectable degree of fade
 - Filter sample with soft/medium/hard filter
 - Selectable trigger volumes
 - Record frequency from 3.0 to 55.9 Khz
 - Full editing and control facility for left/right channels
 - Software selectable left and right digital input volume controls (255 levels)
 - Playback volumes
 - Decrease volume
 - Increase volume
 - Bounce sample
 - Raste sample
 - Trigger recording
 - Clear left/right samples
 - Loop sample

The Special Effects Software

- For the first time ever you can emulate special sound effects in real time just like the sound labs can for film studios, normally the hardware to produce these effects would cost many times more than this package. Features on the FX menu include:
- Built in real time special effects including Echo, Reverb, Ramp, Pitch up/down, Stereo bounce, Multi echo, Chorus, Phaser, Reverse and Pitch bend.
 - Fully programmable special effects so that customised effects can be recalled.
 - Samples can be re-played back through the special effects menu.

The Analytical Software

- A whole host of pro-type analytical functions include:
- 3D display of sample frequencies (Fast fourier transform)
 - 3D display also includes 2D envelope display plus sample information.
 - Built in Stereo spectrum analyzer
 - Stereo Oscilloscopes with trigger markers

The MIDI software

- Easily accessible from pull down menus the new MIDI software suite allows you to trigger samples using either and external MIDI keyboard or the Amigas keyboard. Just look at these features:
- Selectable MIDI channels
 - Multiple MIDI keyboard splits
 - 2 voice polyphonic (Stereo)
 - Load/Save sample set (with settings/splits).
 - Up to 18 Stereo or Mono samples can be mapped onto the keyboard

Other innovative features

- We know this product is years ahead of its time and these additional features justify our boast:
- New style stereo cartridge.
 - Microphone included in package
 - Produces stand alone executable sample files
 - PAL/NTSC full screen display
 - Fully multi tasking
 - Can create workbench icons
 - Saves in IFF/Raw/Instrument1/3/5 Octave
 - Save customised settings

AMIGA

A.M.A.S ORDER FORM

AMIGA

A.M.A.S IS £99.95 Post & Packing £1 (All prices inc V.A.T.)

BY PHONE
WITH
CREDIT CARDS



(0726) 68020



BY POST

With cheque, Postal Order or Credit Cards.

Name...
Address

Postcode.....

Credit Card Type.....Expiry Date.....
Number

Please allow 28 days for delivery

SEND TO: Microdeal PO BOX 68 St Austell Cornwall England PL25 4YB

THE POLITICAL CREW

The sun is here, the blossom is falling from the trees, bunnies are dancing in the fields and the latest swarm of aliens face megadeath from the newly-arrived, sideways-scrolling shoot-em-up. Yes all the essential ingredients for the summer months are here, well one out of four ain't bad.

But before school's out for summer it's the dreaded Screenplay end-of-term test. Sadly the mere thought of examinations is enough to send a shiver down the spine of all but the most gifted of pupils. The fear of failure can ruin a person's life. And none of our lot have the skills required to fill in an unemployment form these days, and a quick check on their school records shows an even sadder state of affairs. But take heart; if they made it – so can you.

Screenplay

Spring is in the air, the Bank Hols are coming thick and fast, but sadly an atmosphere of gloom has descended on the world. Why? It's exam time, that's why. So if you're one of the unlucky bods who faces a summer of studying – forget it, read Screenplay. If you're past the exam-taking point of your life, scoff and laugh at all the poor students, then read on.

NEIL JACKSON

Best exam: Work Avoidance (A level)
Worst exam: Physical Exertion (B-TEC)
Revision material: *Eye of the Beholder 2*

ED RICKETTS

Best exam: Eating (Master's Degree)
Worst exam: Cycling Proficiency (Grade 3)
Revision material: *Project X*

JAMES LEACH

Best exam: Applied comedy (O level)
Worst exam: Keeping a straight face in assembly (CSE)
Revision material: *Battle Isle*

TIM SMITH

Best Exam: Home-brewing (Bass)
Worst exam: Drinking 20 pints and keeping it down (Twyford)
Revision material: A hang-over

MAFF EVANS

Best Exam: Welly-throwing (GCSE)
Worst exam: Finger-painting (RSA)
Revision material: *Monkey Island*

NEIL WEST

Best Exam: Attracting Girls (Advanced)
Worst exam: Coping with Rejection (Pitman)
Revision material: The latest copy of *Amiga Format*



PAGE 50 Flunked school? Join the army. Learn to drive a tank and make tea in billy-cans.



PAGE 54 Is the beauty still in the *Eye of the Beholder 2*? The *Ultima-te* role-play model.



PAGE 66 If you had a family like the Addams, would you really want to rescue them?



PAGE 76 If you mess around in chemistry, sooner or later *Project X* will appear.

ANDY HUTCHINSON

Best Exam: Stilt-walking (B. Smart)
Worst exam: Marital Arts (2nd Dan Black Bed)
Revision material: *Formula One Grand Prix*

EVA HOUGH

Best exam: Rugby (County Championships)
Worst exam: Piano-smashing (300 metres)
Revision material: *Might & Magic 3*

CHRIS LLOYD

Best Exam: Hairdressing (Sassoon)
Worst exam: Art of Zen (Krisna)
Revision material: *Deliverance*

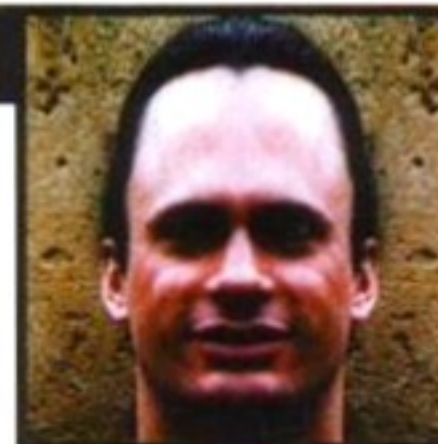
JON PILLAR

Best Exam: Computer Fraud (HMP)
Worst exam: Accounts Management (City & Guilds)
Revision material: *Easy AMOS (?)*



Here's another crop of goodies just waiting for the nuts and bolts to be banged together. **Neil Jackson** takes a look at the latest...

WORK IN PROGRESS



Coktel Vision's South American jaunt, *Inca*, looks set to be both aesthetically and musically pleasing. All you jazz, blues and classical connoisseurs will just absolutely love it, darlings.

Gallic software house, **Coktel Vision**, have announced plans for a stunning new game *Inca*. At the moment the project exists only on the PC, as a CD-ROM game, but Coktel Vision hope to create an Amiga version early next year. *Inca* is a mythical quest set in South America, which uses both 3D real-time animation and digitised graphics. There's also a professionally-written musical score which uses a host of styles including jazz, blues and classical. Initial demos of *Inca* look spellbinding, watch this space.

Also from the Coktel Vision stable, but a lot less gorgeous, is *Bargon Attack*. Its twee plot revolves around a computer game – called *Bargon Attack* – which actually comes to life. It seems that for every Bargon (strange, green, alien-type thingies) you shoot in the game, a real Bargon appears on earth. You then hack and slash your way through Paris, defeating a full-scale invasion. Yes, well...

Slightly more down-to-earth (or rather slightly-above-it) is **MicroProse's** forthcoming simulation, *Harrier*. Planned for November, *Harrier* is destined to be the usual high-quality, no-stoned-left-untuned, technician's-dream of a simulation. You get the opportunity to fly the legendary VTOL super-jet in three different forms: the radar-equipped AV8B, the night attack GR7 and a special easy-peasy MicroProse version. With the addition of fellow wingmen who have their own flying characteristics, *Harrier* could be something of a high-flier.

Meanwhile, back in the fantasy world, those chaps at **SSI** are working on yet another role-playing adventure. Featuring a brand new RPG system, *Midnight Sons* is reckoned to take graphic role-play to new heights. Complete with full-screen smooth scrolling and highly-detailed cinematic animation, the system enables you to just point-and-click in combat. In the game, you control four characters and a robot on their quest to rescue a group of kidnapped diplomats from the far-distant planet of Monsoon.

Last month we told you about the new software house, **Mirage** and their *Lemmings*-basher, *Humans*. This month, they've just announced another game to come from the *Humans* team, **Imagitec**, in September. Called *Gadget Twins*, this platform arcade is a cartoon-style caper, where you (and a friend, if you wish) control a pair of crazy brothers who retrieve a stolen magic gem for the King of Gadget Land, using yo-yos, boxing gloves and hammers. Hopefully, the gameplay is better than the plot, but we shall see.

Jonafon Woss would love this next game, also from **Mirage**. *Dwagons* (as it is sickeningly known) is a fairy-tale adventure which uses a split-screen to combine gameplay graphics and scrolling text. You control two dragons, Snort and Snarl, (who obviously suffer from the annoying Woss-like speech impediment, but don't have a TV show) in their quest to retrieve the magic Talisman of Power from the Evil Lord Flame. Hang on. This all sounds a bit familiar really, doesn't it. Aha! Closer inspection reveals that *Dwagons* is another game from Mirage's pet developers, Imagitec. Hardly surprising, really. ➔

Coming

Ashes of Empire

Mirage Expected: May

In last month's *Amiga Format*, we reported that Mirage were attempting to secure the rights for a program called *Ashes of Empire*. At that stage, it was all hush-hush, as the deal was still incomplete. Since then, Mirage have managed to tie up all the loose ends, and *Ashes of Empire* is definitely on its way. So what's it all about? Well, it's the brainchild of Mike Singleton, creator of *Midwinter* and *Flames of Freedom*, and it's based on the recent events in the Soviet Union and Eastern Bloc countries.

Set in a totalitarian empire which is falling apart, it is full of topics like economic decline, old-fashioned industrial nightmares and human rights problems. You control five republics and 40 provinces, and it's your job to bring peace, economic stability and democracy by securing the trust of the population. If you mess it up, the world could find itself in the depths of full-scale nuclear war.

Carrying on from where *Flames of Freedom* left off, *Ashes of Empire* uses elaborate 3D technology to bring you snow-capped mountains, forests, deserts and a host of other environments to deal with. Expanding on the character interaction of *Flames of Freedom*, *Ashes of Empire* features no less than 9,000 separate characters for you to meet and converse with. And the most important ones move around from province-to-province, so you have to chase around to find them.

Mirage hope to bring you the finished game sometime this summer, but in the meantime look out for an in-depth, Next Big Thing? preview in *Amiga Format*, as soon as playable demos emerge.



More advanced than the *Flames of Freedom*, *Ashes of Empire's* outside view features - trees!



With 9,000 characters to interact with, you'll end up with laryngitis before you finish the game.

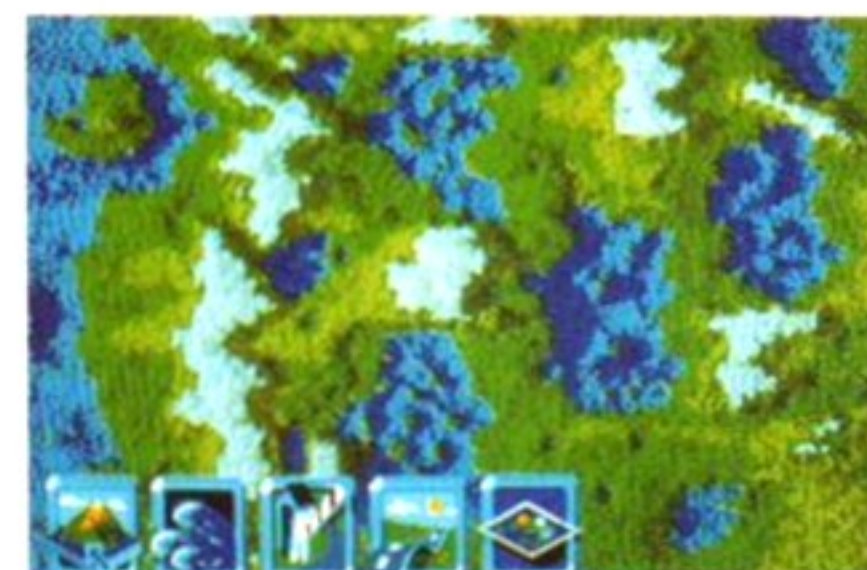

Like its predecessors, *Ashes of Empire* uses a fractal map to help you find your way about.

Lawnmower Man

The Sales Curve Expected: Spring '93

Who'd have thought virtual reality would be responsible for reviving a flagging British film industry? Steven King's strange tale about a gardening-obsessed psychopath in a computer-generated environment, *The Lawnmower Man*, is currently creating huge box-office success in the USA and is soon to be launched in the UK.

The film is a British-made, low-budget affair which has surpassed everyone's expectations. Even better news is the fact that The Sales Curve (proprietors of the Storm label) have picked up the licence for *Lawnmower Man*, and are desperately working on computer-game ideas to coincide with the UK video release. At this stage, they're considering

an arcade and a role-playing adventure, but they're still not sure of quite how to approach the subject of 'teledildonics'.



Coming to a garden centre near you in '93.

Attractions

Shuttle

Virgin Expected: Summer



Virgin's *Shuttle* gives beginners the chance to fly their own space shuttle. Created by Vektor Grafix of *Killing Cloud* and *Bomber* fame, it is the simulation to end all simulations. The entire sequence, from the seven-hour roll along the launchpad road, to the five-hour countdown before lift-off, is all here.

Reach for the Skies

Virgin Expected: Autumn



Rowan Software, creators of *Falcon*, take to the air again with this World War II simulation. You get to play two different roles: pilot and controller. In pilot mode, you intercept German bombers and defend blighty. As a controller, you manage an entire campaign, both in the air and on the ground. Watch the skies this autumn.

Dojo Dan

Europress Expected: July



Europress Software hope to release this action arcade game. A 20-stage mix of puzzles, action and end-of-level guardians, *Dojo Dan* is touted as a console-beater. It certainly has the shallow plot you'd expect from a console game: a mythical land, an evil warlord and hordes of nasties.

Crazy Cars 3

Titus Expected: June



Tired of being the good guy in dozens of cops 'n' crooks chases? Why not sit up and look forward to Titus' long-announced illegal US ace race. After a lot of reshaping, *Crazy Cars III* should finally make it to your screens next month - and it certainly looks fast. Can it challenge *Vroom's* current pole position?

The Bane of Cosmic Forge

US Gold Expected: June



Newcomers to US Gold's team of US developers, Sir-Tech, are putting the finishing touches to their role-playing game. It follows the trends set by *EOTB*, but has an increased potential for spell-casting, it allows 462 possible spell combinations and experience points, plus it includes action and combat sequences.

The Perfect General

UBISoft Expected: June



A cross between *Battle Isles* and almost every Impressions game, here's an unashamed war-game. You play a general who's responsible for directing and applying your military forces in order to gain or hold towns and villages. Definitely one for budding military strategists.

➡ The world (or at least Europe) is in the midst of football craziness - with the FA Cup Final just gone, and the European Championships happening over the next few weeks. US Gold's eyes will be on one player in particular - Gary Lineker, he of the



Not the most inspirational-looking footie game, but that doesn't seem to stop the footie-crazy punters.

amazing feet and winning smile. Why? Because *Kixx*, US Gold's low-price label are rushing to release a compilation of four footie-games which all carry the Lineker seal of approval. Inside their *Lineker Collection*, you'll find such unforgettable classics as *Italy 1990*, *Hot Shot*, *Footballer of the Year 2* and *International Soccer Challenge*. But that's not what our man Gary is really after - he wants the special European Championship wall chart which enables him to follow his progress all the way to the final.

But at the other end of the pitch, *Elite* are charging in with a free kick. They, however seem to be attempting an own goal. How? Remember the coin-op machine of two years ago, *World Cup '90*? Well, *Elite* have at last managed to convert it to the Amiga, but in a fit of sensible marketing, have decided to rename it *European Championship 1992*. Highlights include a stalker who runs across the pitch and gets arrested, and an absent-minded player who has a habit of running into the goal posts and knocking himself out. Strange, but true.

Back in the real world, news has just reached us that *Cannon Fodder*, *Sensible Software's* game without a publisher we previewed in issue 33, has now been signed to Virgin. Look out for this lesson in military madness sometime in the Autumn. *Virgin* have also picked up the rights to *Pool*, the latest idea from brainbox Archer MacLean, of *Jimmy White's Whirlwind Snooker* fame. In theory it's an easy conversion, but Archer has a few more tricks and japes up his sleeves in time for a summer release.



Well we heard it through the grapevine, that the US animation team responsible for these guys are behind a US Gold release. What a wonderful world it will be eh?

Late-breaking news from US Gold, is that of a link-up with American software house, *Cineplay Interactive*. Their first release is an amazing new game called *Free DC* - a futuristic story about a human zoo, set in Washington DC. The really stunning part of the game is the use of full-motion digitised video, combined with Claymation characters (created by the California Raisins team) and recorded speech. *Free DC*, due sometime in June, took no less than 45 people four years to write, and also resulted in a fully-blown, Amiga-based animation suite - which US Gold intend to release very shortly. More news, as it comes in...

Mail order specialists since 1983, Dimension Computers offer a huge range of PC's and peripherals from the World's leading manufacturers at substantial savings.

ALL PRICES INCLUDE VAT

DIMENSION COMPUTERS *ltd.*

DIMENSION HOUSE,
HIGH STREET,
LEICESTER LE1 4FP.

Open: Monday – Friday
9.30am – 5.30pm
Open: Saturday
9.00am – 5.30pm

THE MIDLANDS' LARGEST COMPUTER DEALER

AMIGA

500 + Computer
Commodore mouse
TV modulator
Power supply
Workbench 2.04 disk
Workbench extras disk
Workbench fonts disk
Manuals
Connecting leads



17
GAMES
17
UTILITIES

PLUS: JOYSTICK (may be swapped for a dust cover or 40 cap. disk box), mouse mat AND a pack of the very best public domain shareware games and utilities (worth over £35), compiled exclusively for us to enable you to gain the most from your machine.

SPECIAL PRICE £349.00



Commodore CDTV
Lemmings, Hutchinsons
Encyclopedia control pad **£459.00**
As above, plus
external 3 1/2" disk drive **£499.00**
As pack 2 plus stereo
speakers, internal amplifier ... **£529.00**
KEYBOARD £49.95

BUSINESS SOFTWARE

Mavis Beacon Typing **£29.99**
Pen Pal **£74.99**
Kindwords 2 **£44.99**
Infofile **£44.99**
Deluxe Paint 4 **£84.99**
Mr Backup Pro **£27.99**

PHONE FOR COMPLETE RANGE

AMIGA 1500 BUNDLE

Includes:
DELUXE PAINT III
PLATINUM THE WORKS
HOME ACCOUNTS – DIGITA
LEISURE SOFTWARE
£549.00

MEMORY EXPANSION

ZYDEC 512K + CLOCK **£29.95**
ZYDEC 512K NO CLOCK **£24.95**
A500 + 1Mb Expansion **£52.99**
MEMORY CHIPS FOR H/DRIVES:
256K x 4 drams **£9.99**
1Mb x 9 simms **£49.99**

PRINTERS

Panasonic

Canon

SEIKOSHA

star
COMPUTER PRINTERS

1170 £139.99	BJ10EX £233.99	SP2400 £139.99	LC200 COLOUR £186.99	FR10 £229.99
1124i £218.99	BJ300 £351.99	SP1900+ £104.99	LC24/200 £215.99	FR15 £325.99
1123 £176.99	BJ330 £452.99	SL92 £182.99	LC24/200 COLOUR £264.99	ZA200 £316.99
1624 £374.99	LBP4 Plus LASER £750.99	SP2415 £222.99	LC20 £128.99	ZA250 £410.99
P4450i LASER £1227.99	LBP8 Plus LASER £1256.99	LT20 (under laptop) £257.99	LC15 £227.99	XB24/200 £386.99
P4420 LASER £771.99	Mk III LASER £1209.99	OP104 LASER £668.99	LC24/10 £193.99	XB24/250 £464.99
4455 LASER £1761.99			LC24/15 £386.99	Starlaser 4 LASER £692.99
				Starlaser 8 LASER £1079.99
				Starscript 4 LASER £1009.99
				Starscript 8 LASER £1455.99
				Starjet SJ-48 £222.99

MIRACLE

Piano Teaching System incs. Professional Keyboard designed to work with your Nintendo, IBM PC & Compatible computer or Commodore/Amiga

£289.99

MONITORS MONITOR TV's

GOLDSTAR MONITOR/TV
14" remote control TV 40 programme memory capability full function on screen display **£179.00**
PHILIPS 8833 MK II (inc lead) **£219.00**

ALL PRICES ARE SUBJECT TO CHANGE WITHOUT NOTICE.
ALL ITEMS SUBJECT TO AVAILABILITY.
ADD £8.22 PER BOX CARRIAGE AND PACKING ON ANY ORDER.
GOODS ARE NORMALLY DESPATCHED WITHIN 2 WORKING DAYS OF CLEARED PAYMENT BY OVERNIGHT COURIER.
PLEASE ALLOW 7 WORKING DAYS FOR CHEQUE CLEARANCE.

DRIVES

SUPRA H/Drive 52 Mb + utilities **£339.00**
EXTERNAL 3 1/2", long length lead, on/off switch, thru-port **£59.99**
EXTERNAL 3 1/2" replacement drive **£69.00**

ESSENTIAL ITEMS

QTEC MOUSE **£19.99**
ZYFi STEREO SPEAKERS **£39.95**
DELUXE WORKSTATION (A500) **£49.99**

SALES &
ENQUIRY DESK

0533 517479 / 621874

FAX ENQUIRIES
0533 511638

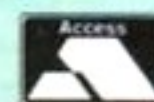

POWER COMPUTING

Commodore A600



The new compact A600 from Commodore
 Built-in TV modulator
 Workbench & Kickstart 2
 Enhanced chip set
 1MB of chip RAM
 IDE hard disk controller built-in
 Credit card size RAM & ROM slot
 A600 £399
 A600 with 20MB £499
 A600 with 40MB £639
 A600 with 80MB £739

Commodore A500+

Amiga 500+, 2MB RAM £339
 A1500, A3000 also available £POA
 Monitors and printers also available £POA

Miscellaneous



10 Maxell disks, optical mouse, Zipstick £45
 Power Mouse £15
 Optical Mouse £29.95
 Replacement optical mouse mat £9.95
 A500 Plastic dust cover £9
 Maxell multi colour branded disks (Box of ten) £9.95
 Floppy disks bulk £POA

Blitz Amiga

Back up disks at lightning speed
 Stops all external drives from clicking
 Contains anti-virus from being written into the bootblocker £25

New PC880B

Now with X-Copy Professional!

Power Computing have teamed up with Cachet of Germany to bring you the ultimate in disk backup systems.

The new **PC880B** disk drive can be used directly with the X-Copy Professional 'Cyclone' software without any extra cables or interfaces. This gives you the the power and reliability of the proven 'Cyclone' backup software with the convenience of the **PC880B** floppy drive.

So now you can have two backup systems 'Blitz' and 'Cyclone' available at the touch of a button! And the **PC880B** still has our unique switchable anti-virus mode, preventing all write accesses to the bootblock of your floppy disks!

If you all ready own a **PC880B**, and the Cyclone copier, a hardware upgrade is available to take your drive up to the latest specification.

New PC880B with Blitz & X-Copy £99.95
New PC880B (Cyclone compatible) £79.95*
 Cyclone hardware upgrade for existing PC880B owners £15.00

*This drive is available only to REGISTERED owners of X-Copy Professional. You must provide proof of purchase of X-Copy Professional.

PC880 Disk drive £49.95
PC881 A500 Internal drive £40.00
PC882 A2000 Internal drive £45
A500 Internal anti-click board £9.95

Special upgrade offer!

If you consider your scanner system to be inferior to the Power Scanner, we will happily upgrade your software and interface for only £49.95 (Power Scanner is compatible with most scanning heads.)



PC501+ RAM Card

Our RAM board is designed specially for the new A500+ computer and comes with 1MB of RAM on board to expand your memory to 2MB of chip RAM. Plug in and go operation (fits into trapdoor). Gives you a total of 2MB of chip RAM £49
 32 chip RAM card £39.95

8MB for any A500



Plugs into side slot
 Fully auto config
 Full thru'port
 Expand 2MB-8MB
 2MB £129 4MB £189
 8MB £299 1 x 4Zip £19.95

2MB for any A500

Economy 2MB RAM externally cased
 16-Chip (1 x 1 DIP)
 No thru'port £99.95

1.5MB RAM Board

Plugs easily into your Amiga
 Fully supports 1MB chip RAM
 Fully compatible with Fatter Agnus £79
 (Kickstart 1.3 and above, not compatible with A500+)
 (Your Amiga needs to be opened, this may effect your warranty)

1MB with Thru'port

Expand your A500's memory to a total of 2MB without disposing of your existing 512K upgrade. Works with 1MB of chip RAM, simple internal fitting. £49.95 (512K RAM must be 4 chip type, or not exceeding 9cm in length) (Your Amiga needs to be opened, this may effect your warranty)

A500 RAM Card

512K RAM expansion with battery backed clock and a free disk packed with useful software (4 chip RAM) £29
 512K RAM card without clock £24
 16 chip RAM card with clock £24
 16 chip RAM card without clock £19 (A500+ compatible)

Aries RAM A1500/A2000

2MB £129 4MB £169 6MB £209 8MB £249

Send your order to Power Computing Ltd, Unit 8 Railton Road, Woburn Road Industrial Estate, Kempston, Bedford MK42 7PN
 Ring your credit card order through on **0234 843388 (10 lines)** or Fax on **0234 840234**. Technical helpline **0234 841882**

All prices include VAT, delivery and are subject to change. Specifications are subject to change without notice. Next day delivery £4.50 (U.K. mainland only), all trademarks acknowledged

STARBLASTER



**Soccer Will Never
Be The Same Again**



Available on the Amiga (one meg only)
and Atari St from mid May 1992
Rage Software unit 21 Edward Pavilion
Albert Dock Liverpool L3 4AA.
Telephone: 051-707 2280 Fax: 051-709 2621



Every picture tells a story. At Palace, they are going just one stage further by telling their stories with live-action digitised pictures. **Neil Jackson** pays them a visit to check up on the plot.

Hyde and Sleek Adventures

Fact one: film studios are organised chaos, and Palace Software's hastily-prepared set-up is no exception. Lamps and cables litter the downbeat spare office which is being used for filming *Jekyll and Hyde*. In an adjoining room, actors and actresses jostle for changing-room space amid row upon row of shelves containing a collector's dream of Victoriana.

Fact two: this is normal. Behind the camera is one thing; the view on the silver screen is another, never would you think that such quality could come from such disorder. In this instance though, the silver screen is where you'll see this masterpiece. Instead, your

"Our aim is CD. We're making a version for disk and an enhanced one for CD. We're keeping all the rushes (the un-edited video footage) because where we use two or three frames on a disk version, we could use the full 50 on CD."
- Tom Lisney, Art Director.



"*Jekyll and Hyde* is not an adventure or role-playing. It's somewhere between the two. There are similar elements and goals, but the emphasis is on character interaction." - Peter Stone, Producer.



Scriptwriter Chantal Riches worked out every possible case of what could happen to each character. Every emotion had to be provided: angry, sad, happy, lustful - the list is endless.

I'm an actor

To cope with such varied emotion, Palace used professional actors and actresses, from *Coronation Street*, *Minder* and TV ads. During filming, each character actor goes through the different expressions and movements that will be used in the digitised artwork. The live-action sequences are shot on broadcast-quality High-band U-matic video for the best possible results. Even then only one frame in 12 is good enough to use in the next stage: digitising. This is done in monochrome using 16 shades of grey. Each image is recoloured, some stay 16 shades, while others are expanded to 256 colours. When you consider there are 60 to 70 locations in the game, plus 22 characters, that's a heck of a lot of work.

The finished images are combined with the AI routines and scrolling text windows which do the story-telling. Still pictures are used to show which characters have arrived on the scene or are interacting with one another. You control your character using a dynamic menuing system which lists your options and enables you to build sentences from verbs and nouns. According to Peter (it provides a wealth of possible responses. You can even embark on a campaign of blackmail and violence if you so desire - but beware of the consequences. Other characters may have less-than-subtle ways of dealing with you.

Jekyll and Hyde could be the most exciting project we've seen for ages, and it's breaking ground many software houses have shied away from: live-action interactivity. Peter doesn't expect to see the game coming together before autumn, so there's plenty of time for things to change and problems to surface. But leaving the studio at the end of filming, I couldn't help thinking the most difficult part of the project was behind them. ☺

BEFORE AND AFTER BUTLER



Ben Bazell plays Parkin, butler to Dr Lanyon, the rival scientist who's out to steal Jekyll's secret potion. Ben's first major part as an actor was as Rocky in the original stage version of the *Rocky Horror Show*. He went on to become a regular presenter for BBC TV's *Play School* programme for young children and later toured the USA, Canada, Europe and Japan as part of the English Shakespeare Company. He has appeared in British TV dramas such as *The Bill* and *Van Der Valk*.

QUIET ON THE SET PLEASE



Being both an exercise in programming and film-making, *Jekyll and Hyde* requires more than the usual 'programmer, artist and musician' to make it take shape. There are no less than nine full-time workers on the project (and

this doesn't include all the actors, assistants and helpers that pitch in daily to help things along).

Amiga is where Palace hope to run their film - except, it won't be a film. Palace's producer Peter Stone, explains: "We got the idea after *Demoniak*. That was an attempt to convey pure fiction in a real-time world with scripted characters, using accepted techniques. The user interface was all-text but for most people that was unacceptable and too experimental. It worked, but it wasn't a huge success.

"The next stage was to make it almost entirely graphical. We spent nine months experimenting with digitised live action using a Rombo VIDI-Amiga system." And it worked well enough to warrant the filming of *Jekyll and Hyde* - an ambitious game where you choose the character you want to become.

Choose a personality

Peter explains how it works: "Each character has their own objective. But you don't have to be the mad scientist, Dr Jekyll - you could play Inspector Harris, the policeman investigating Hyde, or Dr Lanyon, a rival scientist who's trying to steal Jekyll's secret formula. You affect the 'world' with actions and decisions you choose to make. There is artificial intelligence for each character (which took programmer Chris Stangroom four years to perfect), so their responses change depending on what you do."

The trouble with so many possible actions and reactions is it means there must be many more graphic images to represent them. This makes filming a nightmare in story-boarding.

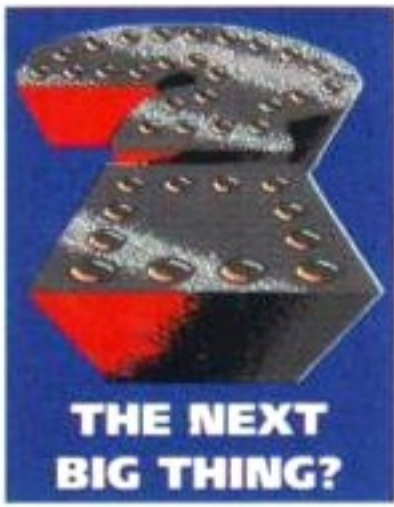

"You've got to experiment!" is Graham Taylor's mantra. And it appears he could be right, that is if *Striker's* revolutionary approach to software soccer pays dividends. **Trenton Webb** keeps score.

Everyone in the universe has played *Kick Off* and all their close relatives own a copy of *Kick Off 2*. So Rage Software seem at a disadvantage before the ball is even kicked, in their bid to redefine footie on the Amiga. Just think, they'd have to come up with a whole new look and playing style, all while embracing those *Kick Off* features that have already become standard. Luckily, that's what they seem to have done.

Striker looks and feels different. Its isometric 3D perspective scrolls the pitch face on, from goalmouth to goalmouth. So *Striker* actually looks like football and not a planning map for *Desert Storm*. Other games tried to use isometric styles – *Emlyn Hughes* and *Manchester United Europe* – but none have worked.

With aftertouch you can really get that keeper diving. Welly it netwards then lean the stick around to send that ball curving away from the keeper.



Striker

AMIGA FORMAT

48

JUNE 1992



The players are smart enough to form a wall when free kicks are taken near the box. But come on ref, that is never 10 yards, I mean play the game!

mainly because they showed the pitch from the side. Both end and side views work equally well in the centre of the pitch, but the perpendicular approach falls foul in the 18-yard box. Seen from the side the goals appear small, and shooting on an angle is desperately dependent on luck. *Striker* though, takes you head on into the goalmouth.

MAKE WAY FOR THE PROPHETS OF RAGE!

Software authors have caught the East European disease of late. Gone are the days when a few monolithic software houses ruled the gaming world, now smaller independent outfits are springing up all over the shop. Rage are one of these new breed of coder/publisher combos.

While their name is new, they are most definitely not beginners, having worked on some of the biggest titles ever seen on the Amiga. As Special FX they put together *Midnight Resistance*, *The*



Untouchables, *Robocop 2*, *Hudson Hawk* and the film tie-in that gave movie licences a good name – *Batman*. If nothing else this proves Rage can turn even average material (à la *Hudson Hawk*) into cracking games, so hopes must be high for what they can do with one of the world's greatest sports!

Bringing the wind of change to games software?



If in doubt take him out! Never let an opponent get this close without attempting to take his knees off. It may be cheating but it's effective!

Large sprites and straight-on goals are all well and good but for a sports sim to work, fast and accurate control is required. Rage have that nailed down too. Control is intuitive, with a fair whack of aftertouch thrown in for experienced goal wagglers. Power is easily regulated and is accurate enough to leave you with absolutely no excuse for missing that open goal.

And accuracy is vital. Here the height of a ball really counts. You can see if a player really has a chance to head a ball or if the keeper can be chipped. This adds greater depth to play as Barnes-like crosses from the wing are possible. Wright-esque defensive headers are vital and Rush-style goal dives are absolutely essential.

The lad done well

Gaining this control is surprisingly easy, even joystick dyslexics will manage to trap, dribble and bend the ball. Learning how quickly the rest of the team move off the ball, though, takes time. Currently players from the same team get twitchy if too many group around the ball, but fixing that will be a tweak to an already finely tuned game engine.



If you choose a sweeper system and find that it is a) effective or b) produces attractive flowing football, then drop it. Remember we are British.

Free-kicks and set pieces fall apart with both traditional isometric footie blasts and overhead scrollers, because of the difficulties in guessing where the ball will end up. Their relative lack of perspective robs players of essential visual clues. Here *Striker* aims to play another 'gamer friendly' masterstroke, as all set-piece play is accompanied with a neat white line that shows the flight path of the ball. Naturally, this gives the trick-shot game away in two-player mode, but it makes set pieces a useful part of the offensive armoury!

Referee!

Added to these novel tweaks, are all the regular extras: action replays, pitch radar, hordes of teams, authentic crowd noise and a huge tournament. So *Striker* looks to have a real shot at top footie honours, but it has a few preliminary matches to win first. At the moment goalies are prone to odd moments of Grobbalar madness and it still has that 'pinball' feel. But the tournament to see who's tops has yet to begin, and as the England manager is keen on saying "now is the perfect time to experiment".

5 GAME PACK



KWIK SNAX

"An ideal game for those who want to have fun"

Amiga Action

PRINCE OF THE YOLKFOLK

"Looks like the best Dizzy adventure yet"

Games-X

BUBBLE DIZZY

"A pure arcade game...Top fun"

Amiga Power

PANIC DIZZY

"A manic test of arcade reflexes"

David Darling

SPELLBOUND DIZZY

"The biggest Dizzy adventure yet"

Games-X

"Five top games smashing onto your screens bringing 100% fun and guaranteed playability! Drive yourself dizzy with three of Dizzy's action-packed arcade games and two brand-new arcade-adventures - the best two Dizzy games ever! All this fun, all this action, all this for £24.99!

Five times the fun of any other games pack!" Richard Darling.

© 1992 Codemasters Limited, PO Box 6, Leamington Spa, Warwickshire CV32 0SH. Tel: 0926 814132.

AMIGA £24.99
ATARI ST £24.99



The bloke who invented tanks must have been a total nutter. Think about it – cooped up in a tin box, with someone lobbing explosives at you. If that doesn't scare you, step this way. Have we got a surprise for you.

Imagine the problems you'd have banged up in four of the flippin' things. *Pacific Islands'* multi-tasking view may look like hard work, but in practice it only requires twice the concentration you'd need to control two tanks, and that's easy, innit?

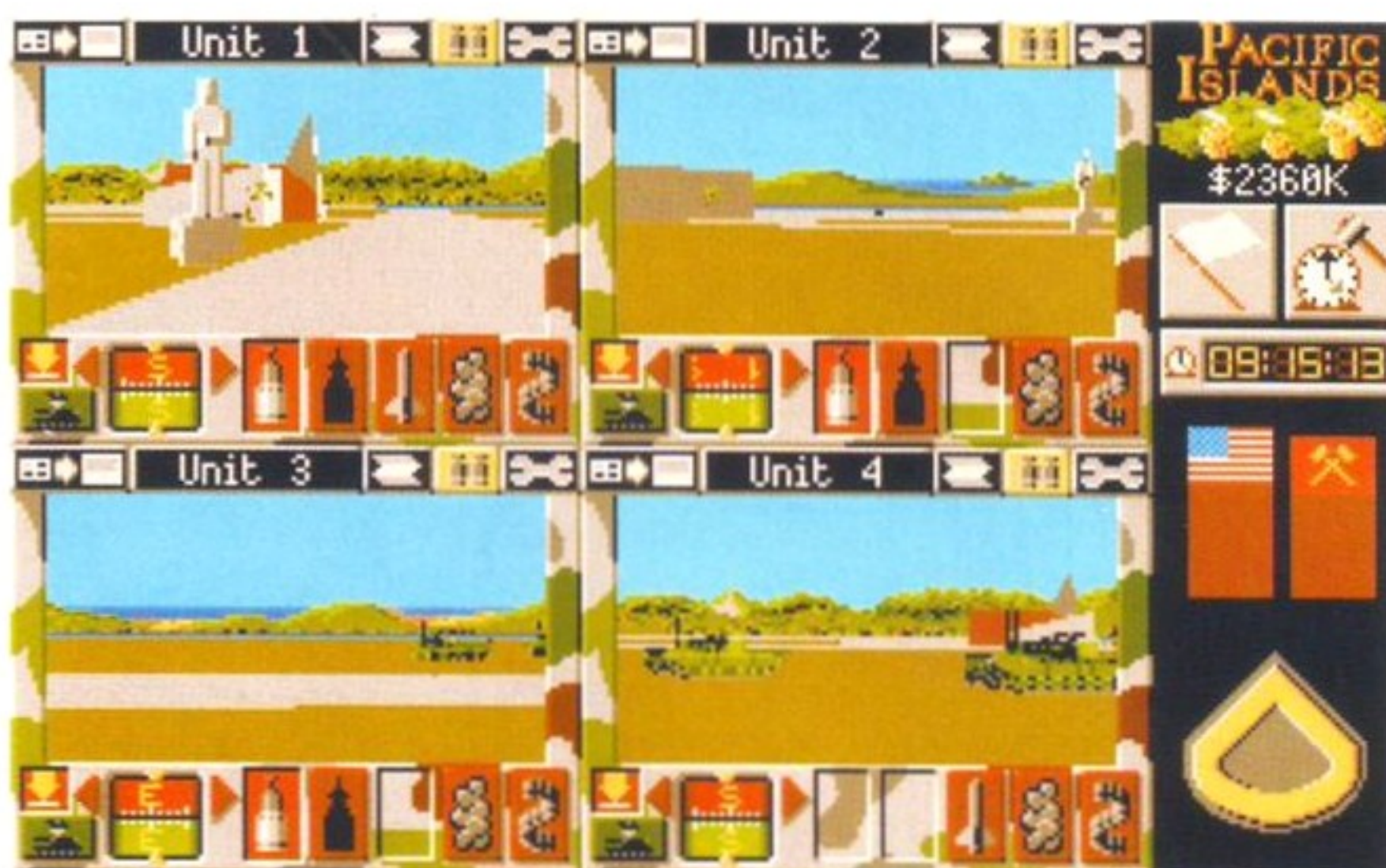

Pacific Islands

AMIGA FORMAT

50

JUNE 1992



View One: right down the barrel. With your engine-smoke on and laser-guided shells, you go about your dirty work. Using the zoom mode, your superior range stops you being the one who's on the receiving end, for a while.

The Yankees are at war again, but this time it's a bit different. As always, they're fighting Soviet tanks but the Russians aren't involved because they're busy deciding who owns their army. Instead, you're fighting North Koreans because they've just invaded the Yama Yama islands. Why North Koreans? Because they're the nearest, and the Batley Townswomen's Guild (Armoured Division) are too busy fighting insurgency in Peckham. As far as Empire are concerned, it doesn't matter who you're up against – just accept the fact that they're not very nice, OK?

Specific requirements

Your task is to liberate the archipelagos and drive out the occupying army. You have up to four units (and four vehicles) under your control, with the option to replenish your forces in between battles. The method of control is similar to Empire's earlier *Team Yankee* but with a few enhancements. As before, each unit has three displays: a map, a status display and a turret view. You switch between displays using Workbench-style window controls in the top corner. You can view a single unit's displays at full-screen size or all four units together at quarter-size. This lets you keep track of everything, but you need to be able to multi-task your brain to do this effectively.

The chief difference to *Team Yankee* is



View Two: when it's time to start moving. Whether you're charging or hiding, the navigation map is your ticket to ride. A single click guides you. You can also use it to spot enemies or zoom right in to see each tank in each of your four units.

the emphasis on management of the whole campaign. Depending on your success in battle, the amount of damage to innocent villages and the speed of your campaign, you receive a variable supply of cash. It's up to you to spend it wisely and guarantee a constant supply.

You decide whether and when to rest your troops to get morale back, or repair damaged tanks. Both actions waste time and allow your opponent to lick its wounds and repair its own damage, making it tougher in the next battle.



View Three: assessing your damage. If you've taken a few hits, the bars warn you that your tanks are breaking, or your troops are about to wet themselves. Between missions you can try to rebuild your armour and mend broken spirits.

The longer you take to wipe them out, the less popular the war is "back home" and the less cash you get. But sometimes losing time can work to your advantage, especially if you're deliberately advancing the clock so you can use the cover of darkness on your next mission. You're the one who has to make the financial, as well as tactical, decisions on the campaign trail. Be prepared to play the same missions over a few times before you get the balance right.



For safety's sake, use your engine smoke. It covers you from enemy fire, and lets you know which tanks are yours. It's easy to mess up in the fog of war – but you should be the only one making it.





At first glance, *Pacific Islands* is a daunting prospect. It's hard enough to concentrate on one tank group without having to contend with four at once. But a few tactics can make the difference between success and abject failure.

Your first action should always be to read the mission details thoroughly. Occasionally there are clues as to the most likely places you'll be ambushed. More often than not, the direct route is the one the enemy expects you to follow and they'll be waiting near it, usually in the cover of trees. So think about using a longer route which enables you to approach the target

There is a tendency towards frustration at the beginning, but *Pacific Islands* has plenty of staying power. Five islands, make up a total of 21 individual battles (each lasting around 40 minutes). It takes several attempts (and probably about 10 hours) to complete just the five battles on the first island. Even when you've liberated it, you could still have problems later on if you've messed up your tactics or spent too much. Those of you looking for a quick *Battlezone*-style shoot-out are likely to end up tugging your hair out in handfuls – *Pacific Islands* is a test of tactical skill first and reflexes last, but both are indispensable.

Let's talk about tactics

Every mission requires thought and planning, and usually at least two attempts to get it right. The first time you play through the battles you're likely to suffer a few surprises. After a couple of attempts, you can generally predict where the enemy is likely to ambush you, or where their weakest points are. To prepare you, there's a training ground and it's worth

from behind or the sides. You're less likely to get japped on the way.

Often this tactic takes you across the enemy's line of sight, so use a smoke barrage to block the gaps between forests where you're exposed. You have to time the barrage so that it coincides with your arrival. If in doubt, call it in a tiny bit later than you think you need to; You can always make your units wait in the trees until the smoke appears, but if they arrive too late, the enemy will have seen the

smoke and already be charging over to find you. Sometimes you can save yourself a bit of work by using the artillery HE barrage to destroy secondary targets. Call the strike in right at the start of the mission to improve the chances of killing off the target and getting the best from an enemy morale-drop. You should make sure you visit the target yourself, just to make sure it's been totally wiped out and finish it off if it hasn't. Using artillery for static targets like radar installations and fuel dumps is usually more successful than using it against enemy tanks, purely because it's difficult to predict where they'll be. Beware of using

using this (even if you think you're the best general since Stormin' Norman), just to get used to the strength of each of your ammunition types. High-Explosive Anti Tank (HEAT) shells are great for popping tanks, but not so good at piercing thick factory walls where sleeved SABOT rounds are more effective.

By far the best weapon is the guided missile, but this has two strings attached that are

“Speed is high and so is the detail. It's easy to forget the 'virtual' part of this virtual reality.”

worth considering: you need to be stationary to fire missiles, and the missile-firers are the weakest units of all. This means that you really have to prepare properly when launching a missile attack. Testing it all on the training ground in total safety means that you won't suffer a frustrating demise in the real heat of the action.

DESERT ISLAND RISKS

Your guide to tricks, tracks and tank tactics

artillery on targets in villages – you may knock out a factory, but you'll probably destroy a church and several innocent houses as well, with a resulting drop in your budget due to excess collateral damage.

Using engine smoke and infra-red battle-sights is paramount in daytime battles. Most enemy tanks don't have any infra-red capability, so you can be reasonably bold when you mount an assault. Another tactic worth employing is driving your units along the tree-line (the 100-metre perimeter of forests) wherever possible. Enemy units are much less likely to see your green hardware if it's on a green background until you start firing in earnest.

There are many targets that are neither primary nor secondary objectives, but they can help you gain an overall advantage. You must concentrate on the key targets or you won't win the battles, but destroying ancillaries like enemy communications radars and military command posts helps your war effort overall. The enemy also uses many fast-but-small scout units which spot you at long range and then warn their reinforcements to advance. If you deal with these quickly, they can't relay information back to their support troops and your chance of surprise is greater.

From a player's point-of-view, it's an uphill struggle, but one that's worth going up. Because you have to work so hard to complete each mission, it's rewarding when you succeed. Part of this is due to atmosphere – the blend of sprite tanks and forests with vector-drawn buildings and roads gives you the best of both worlds. Frame update speed is high, and so is the detail. It's easy to forget the 'virtual' part of this virtual reality.

Sound effects also play a major part in the game, and not just for atmosphere. Knowing when you're under fire is vital and the sound effects make it deadly clear. When you hear shells around you for the first time, you're bound to panic trying to locate the unfortunate unit and then the attacker. War poet, Wilfred Owen, summed it all up by describing this moment as “an ecstasy of fumbling” – if you've ever wondered what that meant, play *Pacific Islands*. Frighteningly realistic, playing is like juggling with smouldering dynamite. Lose your cool once, and you're dead.

Neil Jackson



All the tough targets are heavily defended through *Pacific Islands* and radar installations (like this pile used to be) are no exception. They're worth taking a few risks for, but don't come close up to destroy them until the shelling dies down. Or you'll die.

Pacific Islands Empire ■ £29.99

- A fantastic mix of game-styles: sprites, vectors, action and tactics all rub shoulders without problems.
- Realistic enough to know that you'll never want to be a tank commander in the next Gulf War.
- Hours of fun and frustration.
- Plenty of appeal for both strategists and arcaders.

GOLD 93%

WeServe of Hampshire Established 7 years

High quality products. Full technical support.

High quality products. Full technical support.

<p>NEW Amiga Workstation /Expansion System Monitor stand with shelf for drives etc. Strong metal construction made from 14SWG steel epoxy coated Amiga colour. Special price £27.50</p>	<p>Midi Interface 4 channel Midi Interface for Amiga £29 Dr. T's Midi Music Software (not suitable for A500+) £9.95</p>	<p>Hard Disks Supra 500XP 52M for A500 £329 Commodore A590 20M Hard Disk for A500 £249 GVP Series 2 52M for A500 £369 GVP Series 2 105M for A500 £469 GVP Series 2 52M for A1500 £279 1M Simm Suitable for GVP Hard Disks etc. £29.90 per 1Mb £29.90</p>	<p>Floppy Drives Cumana CAX354 The most reliable drive you can buy 1M external £52 While stocks last</p>
<p>New Price Citizen 224 24pin Colour* Enhanced 24pin printer, *optional colour with easy to use control panel 2 year warranty. Price with cable & paper Mono £215 Colour £234 Amiga printer driver £5.00</p>	<p>New Price HP Deskjet Colour 300dpi colour inkjet printer. Colour laser quality at 1/10 of the cost. 3 year warranty. Price with cable & paper £559</p>	<p>Commodore A1011 1M external £56 While stocks last</p>	<p>Commodore A1011 1M external £56 While stocks last</p>
<p>All Citizen printers have 2 year warranty</p>	<p>Deskjet 500 HP 300dpi Inkjet printer. Laser quality at dot matrix price. 3 year warranty. With cable & paper £359</p>	<p>Commodore 1084SD 14" Colour Monitor with cable dot pitch 0.42mm £229 While stocks last</p>	<p>Roctec RocLite RF382C 1M external £56</p>
<p>Swift 24E Enhanced 24pin. Colour printer with cable & paper £269</p>	<p>Printer Drivers Citizen Swift Colour 5.00 Canon BJ-10e 4.95 Deskjet 500 Colour 9.95</p>	<p>1M Simm Suitable for GVP Hard Disks etc. £29.90 per 1Mb £29.90</p>	<p>GVP Series 2 120M Hard Disk for A1500 £419</p>
<p>Citizen Swift 9 with cable & paper Mono £175 Colour £194</p>	<p>Printer Dust Covers most types in stock from £4.70 inc VAT</p>	<p>Commodore 1085SD 14" Colour Monitor with cable dot pitch 0.52mm £199</p>	<p>A2286 Bridgeboard CBM 286 Bridgeboard for A1500 £319</p>
<p>Citizen 120D + with cable & paper £119</p>	<p>Canon BJ-10ex 360dpi Inkjet printer with cable & paper £235</p>	<p>Commodore 1084SD 14" Colour Monitor with cable dot pitch 0.42mm £229 While stocks last</p>	<p>Amiga 1500 with full software pack £499</p>
<p>Panasonic KXP1123 Probably the best 24pin mono printer available. With cable & paper £179</p>	<p>Star SJ-48 360dpi Inkjet printer with cable & paper £229</p>	<p>Philips CM8833 MK2 Colour monitor with cable £219 UK. 240V with 13A mains lead</p>	<p>1/2 Meg Ram + Clock £24.95</p>
<p>Panasonic/Epson KXP1170 9pin 134 KXP1124i 24pin 227 Epson LX400 9pin 135 Epson LQ450 24pin 222 Epson LQ570 24pin 265 Epson EPL-4100 Laser.. 680 Epson EPL-8100 Laser.. 1115 Prices include VAT cable & paper</p>	<p>Star LC20 Mono 9pin 129 LC200 Colour 9pin 189 LC2420 Mono 24pin 195 LC24200 Mono 24pin 219 LC24200 Colour 24pin .. 269 Prices include VAT cable & paper</p>	<p>Protar Visto 14CM 14" Colour Monitor with cable £199</p>	<p>A500 PLUS Cartoon Classics full software pack £319</p>
<p>Naksha Mouse for Atari ST & Amiga with house & mat £21.50</p>	<p>Rocgen Plus Genlock with RBG switcher £129</p>	<p>Accessories Joystick/Mouse twin extension 4.70 3M Joystick/Mouse lead 3.75 A500 Printer cable 7.95 Modulator/Disk Extension 10.95 23way Plug or socket 2.95 A500 Dust Cover 4.70 A501 1/2M Memory + Clock 29.00 Mouse Mat (thick soft type) .. 4.95 Mouse House 2.95 1M internal 3.5" drive 57.50 A500 replacement PSU 39.00 1/2Meg Ram NO Clock 23.90 Delta 3AS Analogue Joystick 15.90</p>	<p>SONY DISKETTES SONY branded (lifetime warranty) (100% certified error free) 10x 3.5" DS/DD 135tpi 7.50 50x 3.5" DS/DD 135tpi 32.30 100x3.5" DS/DD 135tpi 59.93 250x3.5" DS/DD 135tpi 141.00 1kx 3.5" DS/DD 135tpi 540.50</p>
<p>Squik Mouse for Atari ST & Amiga £13.90</p>	<p>Kickstart Upgrades Commodore 2.04 full upgrade 79.00 Kickstart ROM only v2.04 41.50 Kickstart ROM only v1.3 29.00 Phoenix Rom sharer 24.95 VXL30 25MHz Accelerator ..239.00 Fatter Angus custom chip 37.50 A590 or Supra Hard disk PSU 49.00</p>	<p>Accessories Joystick/Mouse twin extension 4.70 3M Joystick/Mouse lead 3.75 A500 Printer cable 7.95 Modulator/Disk Extension 10.95 23way Plug or socket 2.95 A500 Dust Cover 4.70 A501 1/2M Memory + Clock 29.00 Mouse Mat (thick soft type) .. 4.95 Mouse House 2.95 1M internal 3.5" drive 57.50 A500 replacement PSU 39.00 1/2Meg Ram NO Clock 23.90 Delta 3AS Analogue Joystick 15.90</p>	<p>DISKETTES SONY / DYSAN bulk (lifetime warranty) (100% certified error free) 10x 3.5" DS/DD 135tpi 5.95 50x 3.5" DS/DD 135tpi 21.86 100x3.5" DS/DD 135tpi 39.60 250x3.5" DS/DD 135tpi 94.88 1kx 3.5" DS/DD 135tpi 353.68 40 x 3.5" Disk box with lock 5.49 100 x 3.5" Disk box with lock .. 7.50 Carriage on 50+ disks £3.53</p>
	<p>Naksha Scanner 200 to 400dpi. 105mm width with express-IT software New Price £99</p>	<p>WeServe Larger items delivered by Securicor</p>	<p>Phone for our 60 page catalogue EDUCATIONAL AND GOVERNMENT ORDERS WELCOME All products have a 30 day money back & 12 month warranty. Prices are subject to variation without prior notification. Established 7 years. 3 minutes from M27 Junction 11. Free parking. Open 9 to 5.30 Monday to Friday & 9 to 5 Saturday Postage 94p or £3.53 Securicor £6.46 (£5.50 + VAT)</p> <p>Amiga/Format Dept. 40-42 West Street Portchester Hants PO16 9UW Tel: 0705 325354</p>

Visit our Showrooms. See before you buy.

Visit our Showrooms. See before you buy.

JUN 92

Five years and a million fashions ago, a white-suited punter landed on our screens. Larry Laffer, nerd incarnate, and hapless pursuer of female attention. Al Lowe's touchingly obnoxious anti-hero, forever in search of censored action, spawned a whole series of highly-suggestive graphic adventures. Now Sierra have brought him back with an all-mouse interface and Nineties backdrops. Will he recapture our glands?

At 40, Larry Laffer boasts little more than \$94, his breath spray and an insatiable appetite for romance. Starting at the seediest hangout in town, Lefty's Bar, he works his way through dark alleys, garish discos and dubious hotels in search of first love. He becomes intimately acquainted with the ups and (more frequently) downs of life, leaving a trail of broken hearts, windows, or bones in his wake. More often than not, however, he finds himself the victim of impossible circumstances. It is up to you to solve the plethora of puzzles, so that Larry-turned-hero can embrace the (current) girl of his dreams in the end.

By far the most original and, although hidden beneath a layer of innuendoes, wittiest of the quartet, *Larry 1* has now been shaped up to meet today's standards. Keyboard commands have been replaced by an icon bar along the top of the screen. Current modes are shown by the shape of the cursor and changed by right mouse clicks (look, walk, manipulate, etc), actions performed by left mouse clicks directed at specific objects, people or locations. While friends of the keyboard will deplore the loss of language, others might welcome the straightforward interface.

A literal creep

Sporting a jaunty gait, Larry strides up to the counter – except that, in fact, he doesn't. He rather creeps up to his destination, waddles across the room and exits it so slowly you

A new-look Larry in an old-style game, and yet he's still a total jerk. Some things never change. Sierra attempt to breathe new life into an old idea with the remake of *Leisure Suit Larry 1*.



Ever tried reversing the charges when you're phoning the number on those little cards people leave in phone-booths? Try it. Works every time.



Like all singles bars, the drinks are expensive and the company is cheap. But still Larry has a hard time making an impression – except on the floor.



Leisure Suit Larry 1

might be tempted to, say, mow the lawn, format a few disks or ring up a friend in the meantime. Maybe even do all three if you're installing it on anything less than an A3000.

Willy

The graphics have been directly converted from the PC – and downgraded to 32 colours. A drab, fuzzy scenery is the outcome, with some objects barely discernible. Clear, if placative surfaces (as in the older adventures) and marked lines (as in *Willy Beamish*) would definitely have helped the player. As it were, you are left to admire the bizarre perspectives, wondering what the locations would look like if properly redrawn.

If fuzziness is the future of graphics, what lies in wait for your ears? Certainly, the sound effects (mostly the ones accompanying the lesser dealings of life) are all there. But without a Roland sound card the music comes out thin, monotonous and uninspired.

Larry comes on four disks and a technical manual, a handful of beginners' tips and three lewdly suggestive (copy protection) leaflets.



All the best thinkers used to do this sort of thing. Socrates had a permanent ring around his bottom, and Jean-Paul Sartre couldn't begin to make sense unless he'd been on the throne for an hour or two. Maybe it's got something to do with the proximity of the writing paper.

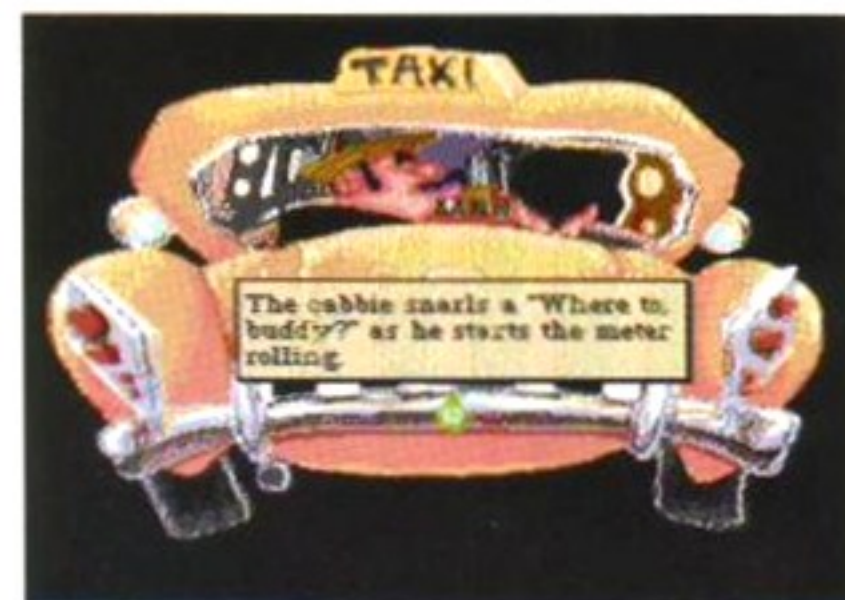

I've got me a car and it seats about 20 and we're heading on down to the Loveshack, baby.

You need two drives or (highly recommended) a hard drive and at least one meg. Even so, the pleasure of playing departs with the first waiting sessions. Instead of setting a role model for modern classics, Sierra prove that sloppy, off-hand conversions from the PC can actually do a game more harm than good. The first version of Al Lowe's classic is far more fun. When will they learn to take the trouble of proper reprogramming that is worthy of the Amiga?

If you can't lay hands on an 'old' *Larry 1* and are dying to live the legend, bring along a bulging purse and a huge thermos of coffee. At least the story has lost none of its appeal. Still, unless your machine boasts a turbo card or a 3000 label, don't even begin to worry about hormonal overdoses...

Eva Hoogh

Leisure Suit Larry 1 Sierra ■ £39.99

- The original: Larry's lamentable lovesickness makes for loads of fun.
- Abysmal graphics.
- Bearable movement, loading time and full animation only with turbo card or an A3000.
- Tinny music.

AMIGA
Verdict 53%
FORMAT



It's that time again, folks. The sequel that the world has been begging for has finally arrived. Now's your chance to plunge yourself deep into monster-related magical trouble all over again, in...

Eye of the Beholder 2

The Legend of Darkmoon



There we were, having a break, and a rummage through our backpacks, and out jumps a Mantisman. These insectoid muties may only be armed with tiny daggers, but they don't half move.

When you think of fantasy role-playing games on the Amiga, the name which springs to mind is *Eye of the Beholder* – US Gold's massive hit from a year or so ago. According to many, this was the benchmark against which all successive fantasy games would be measured. But now US Gold are following in their own footsteps by launching *The Legend of Darkmoon*, part two of the *Eye of the Beholder* story. As a sequel to the best, you'd expect a multitude of enhancements and new ideas. Read on to find out just how far you can take a good idea.

By now almost all games-playing Amiga owners should be aware of *Eye of the Beholder*. If not, drop this mag now and grab a



We're not saying what these pod-like things are, cos that'll spoil it. Let's just say it's perfectly safe to run up and bash them, perhaps.

copy or you'll have missed out on a truly classic piece of software. The old *EOB* (as it was known) set the pace for in-game atmosphere, tension, plot and brain-stretching. Since then, though, many games (*Knightmare*, *Captive* and *Black Crypt* to name a few) have attempted to create the same level of excitement but all have fallen short of the mark. Perhaps this was due to the TSR-approved Advanced Dungeons and Dragons rules, complete with tried-and-tested spells and familiar monsters. Certainly part of its success was due to the atmospheric sound effects and gorgeous graphics which really helped to put you deep in the dungeons.

Auld acquaintances not forgotten

The Legend of Darkmoon attempts to pick up where *Eye of the Beholder* left off. Indeed, you

can transfer your original *EOB* party of adventurers over to the new game, complete with all their baggage. This is preferable to generating a new set of team-members because your old crew are likely to be more highly qualified than a batch of newcomers. Consequently they'll last longer when the fighting gets really tough (around level four). With an old team, you can storm through the first levels (which

ing or attacking the monster, but don't let looks fool you. Sometimes even good people are vile, vicious enemies underneath.

Real-people power

The Legend of Darkmoon also features some enhancements, but for my money there aren't enough. There are many more short 'cameos' which improve the story-telling aspect of the *EOB* system, but in fairness, they're not much more than the picture-and-words gimmick of old graphic adventures. One particularly useful enhancement is the new 'awareness' of your own party-members. Now, when you pass a secret door or a hidden switch, one of your crew informs you (usually in cryptic terms) in another passage of text at the bottom of the screen. This helps improve rapport with your party. You start to think of them as individuals, which is a boon to role-players. But don't push it – if you walk past the trigger square too many times, the messages repeat, making your characters seem a bit fake after a while. At least you're less likely to miss the important, secret bits of the game, and the messages don't give too much of the game away too easily.

Beyond this, *The Legend of Darkmoon* is pretty much the same as *Eye of the Beholder*. The graphics are different, but they are in the

"The Legend of Darkmoon is every bit as good as its predecessor (and a bit better in many places)."

include a forest and the catacombs of Temple Darkmoon). Some monsters, like the wolves in the woods, vanish after a single good thwack.

But don't think *The Legend of Darkmoon* is easy – soon things get a good deal harder and you may not even be sure who you should be hitting. One or two of the monsters you meet may not seem evil or harmful at first. Usually, these suspicious cases cause a special encounter screen to be displayed. This shows a different view of the character you encounter and a brief passage of text explains what's happening. You usually have the choice of aid-



Skeletal warriors return from Waterdeep to haunt you in *Darkmoon*, and they're every bit as tough as they were last time. Immune to magic and relentless in their attacks, they can turn even the hardest party into a pile of blood and guts if they surround you.



Laugh while you learn with



ADI



Exploring English, Maths and French will never be the same again thanks to ADI, the lovable extra-terrestrial who comes crashing into your computer. He will entertain you with his funny remarks, whistly voice and weird facial expressions. He'll congratulate you when you do well and cajole you when you make those silly mistakes.

With one for each school year the packages accurately follow the guidelines of the National Curriculum, drawing on the talents of some of the most gifted teachers in the country. As a result ADI ideally complements what students are learning in school.

Available June 25th:

English 11/12 Improve your knowledge of pronouns, verbs, adverbs, spelling, use of capital letters, synonyms, opposites and prefixes/suffixes.

English 12/13 Make the most of dictionaries and reference books; construct adverbs; learn to proof read; link sentences and punctuate sentences.

Maths 11/12 Covers geometry, algebra, statistics, line and rotational symmetry, quadrilaterals, number operations and other fundamental concepts.

Maths 12/13 Calculate angles, area and volume; add, subtract, multiply and divide fractions; perform mental calculations; and manipulate directed numbers

...yet each pack costs just £25.99!

Available in the autumn:

Maths and English for 13/14 and 14/15, plus French 11/12, 12/13, 13/14, 14/15.

Join the ADI family today!

EUROPRESS
SOFTWARE

Europa House, Adlington Park,
Macclesfield SK10 4NP
Telephone: 0625 859333



On sale at all good software retailers including Boots, Virgin and WH Smith.



A secret passage? Nah, you wouldn't know a secret passage from a hole in the ground. Well looky here. Would you believe it? It's a hole in the ground. Shush! It's a secret. Damn! What a giveaway.



This tranquil town is under threat - something nasty is going down at Temple Darkmoon and the big cheese wants you to root it out. Like a fool, you're bound to think you can do it, an' all.

same style, and the sound effects are the same, even down to the twang of the bow and arrow. Magical stone portals can be found, just as they could in *EOB*, and they work in exactly the same way, and use the same graphic effects. The animation for the monsters is the same two- or three-frame jerky affair, even though many of the monsters are different AD&D beasts. The hideous floating Beholder (the star of *EOB*) makes plenty of appearances and is by no means the toughest creature you have to deal with.

Party till you drop

All in all, *The Legend of Darkmoon* is every bit as good as its predecessor (and a bit better in many places), but it's not quite the kickin', radically-different mega-game it could be. Pretty soon, the novelty wears off, and you're just playing the same old *EOB*, but with a different plot. OK, so the plot is bigger and better and the puzzles are harder and more time-

consuming, but you can't help feeling you've been here before. Even so, if you were impressed by *EOB*, you're bound to be impressed by *Legend of Darkmoon*. If you only buy one role-playing game this year, make sure it's this one, because despite a lack of significant improvements, it's still the best. For more radical changes, you'll have to wait until next year - SSI and US Gold are planning *EOB3* and they're mumbling things like "auto-mapping" and "party-member interaction". Oh, and by the way, angelic-looking priests are not always what they seem. Nuff said...

Neil Jackson

The Legend of Darkmoon SSI/US Gold ■ £35.99

- Strong storyline provides excellent entertainment that'll last for days.
- Tried-and-tested gameplay, with enhanced characters and descriptive interludes.
- Tricky puzzle encounters make this a true-to-form, Dungeons-and-Dragons bash.
- Familiar controls but no real improvements.
- Still the best of the bunch.

AMIGA
GOLD 91%
FORMAT



If you go down to the woods today, you're sure of a big surprise. You know what it's like when your dog gets hold of your teddy, don't you?

"THE BEST RPG/ADVENTURE GAME OF THE YEAR,* JUST GOT BETTER...!!"

300,000 years ago, the Ancients ruled the galaxy, and then destroyed themselves in a suicidal war, leaving only ruined cities and devastated planets. Even today, the ruins of the Ancients are puzzling; mysterious and dazzling artifacts are still unearthed at various ancient sites throughout the Spinward Marches.

Now one of the ancient sites has mysteriously sprung to life, running amok and threatening to destroy an entire world. Millions will perish if the ancient site isn't stopped. Ancient sites spread across a dozen worlds, hold clues, and even ancient artifacts that may neutralise the destructive site.

But ultimately, you'll need to find the legendary Ancient leader who has been reportedly dead for 300,000 years!

Only you can discover if the legend of the Ancient one is true as you play Traveller like you've never played it before in Megatraveller 2; Quest for the Ancients.



Now, the best RPG/Adventure game of the year just got better!!

The game begins as you and your party set out to stop the slime producing Ancient sites on Rhyllanor. There are 127 detailed worlds to explore with hundreds of cities and millions of square miles.

You can travel from planet to planet aboard commercial starships, or one of your characters may own his own ship. Explore hundreds of locations including

cities, data terminals, starships with deck plans, gambling casinos, stores and shops, taverns, trade and commerce outlets, vehicle rental locations, character recruitment centres, crashed and abandoned ships and Ancient sites.

At each of the Ancient sites, you can discover artifacts and relics that can help the crisis situation on Rhyllanor. By helping the situation, you will receive very significant rewards, which will help you to buy passage, or even acquire your own ship so that you can continue your quest.

Throughout your adventure, you will be pursued by agents of the secret organisation.

As well as a main plot, there are dozens of sub-plots on the various worlds, and even aboard starships, to keep you and your party busy.

You will be confronted with interesting adventures filled with mystery, danger and intrigue.

Megatraveller 2: Quest for the Ancients is a unique and innovative role-playing adventure that goes leaps and bounds beyond Megatraveller 1.

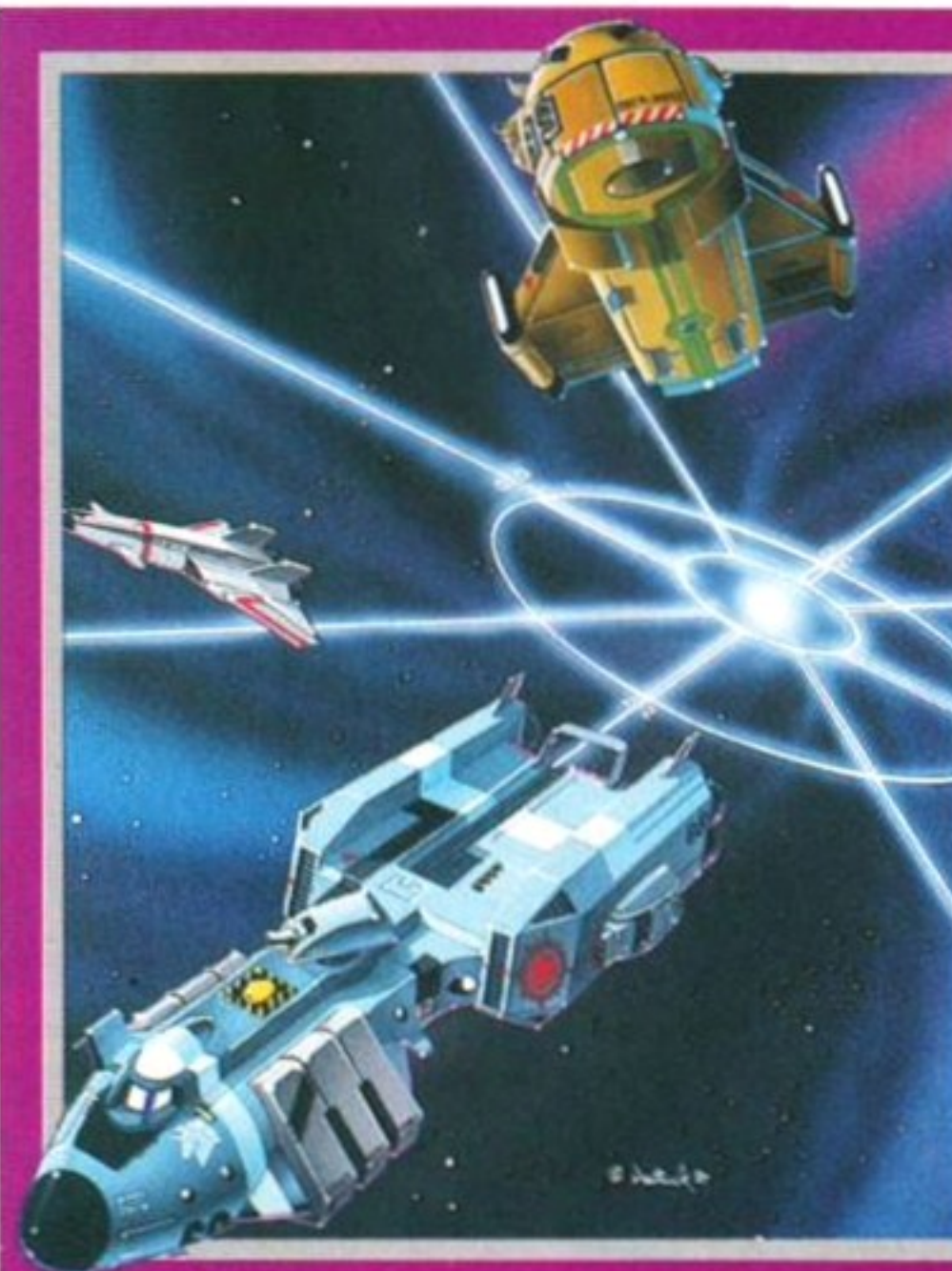

MEGATRAVELLER 2 QUEST FOR THE ANCIENTS

The game features the most advanced and comprehensive character generation system ever developed as well as the most intuitive combat system for ground and space conflicts. The overhead perspective is equally unique, showing your entire party from a perspective that realistically represents a large, modern city.

Megatraveller 2 features a much more graphic-intensive presentation than Megatraveller 1. An enhanced trade and commerce system is implemented in Megatraveller 2. The new economic system is much more realistic and benefits from the substantial increase in worlds.

Megatraveller 2 uses the PAL system: you are the leader of the party, and the others act as your friends. You can give orders, but acting intelligently based on the skills and the characteristics they possess, they may not follow your instructions if they believe that

different actions on their parts will ultimately help you in a more effective way.

There are hundreds of NPC's to meet, converse and trade with during your adventure.

Overall, Megatraveller 2: Quest for the Ancients is an all new game with exciting advanced features.

The sheer size and scope of the game with over 127 different worlds to explore will keep you playing time and time again. This together with the superb graphics and animated sequences and the revolutionary PAL role-playing system, make for the most exciting adventure yet seen on a Home Computer.

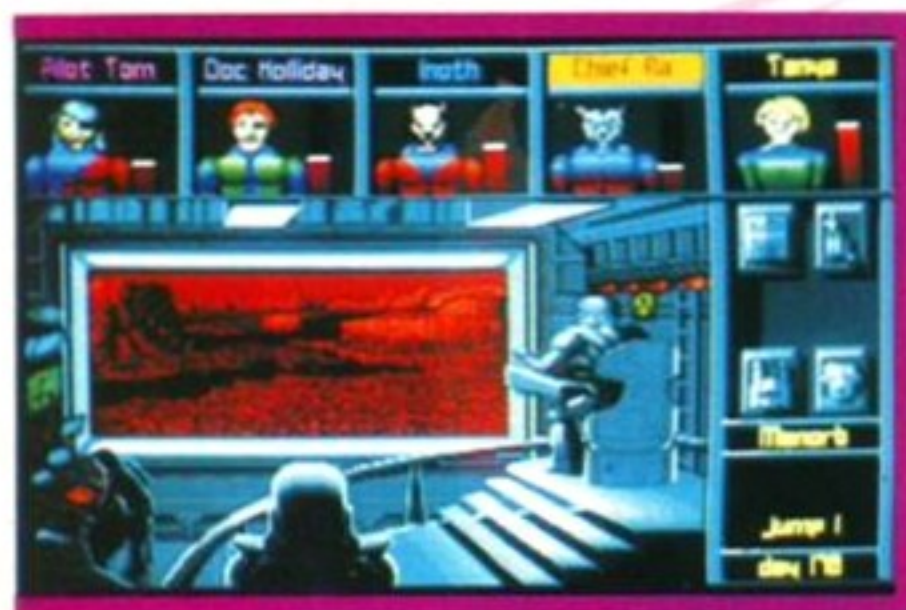

For years, Traveller was the undisputed champion of science fiction role playing. A game of unprecedented magnitude, there was no aspect of spacefaring adventure that Traveller didn't handle, and handle exquisitely. Then along came Megatraveller, a complete redesign of the original Traveller that stands as one of the most remarkable gaming achievements of the last decade.

Superbly designed, Megatraveller was quoted as the pinnacle of science fiction role-playing.



RELEASE DETAILS
AVAILABLE ON: IBM PC & COMPATIBLES,
ATARI ST AND CBM AMIGA

Warfare has often been the base for video games, even as far back as Taito's coin-op *Commando* and US Gold's *Beach Head* series on the C64 back in the Eighties. Most battlefield games involving infantry have tended to fall into two categories – the straight shoot-em-up with the player gunning down everything in sight, or the tactical strategy game approach with all the moves being planned on maps. MicroProse have taken a slightly different view, combining strategic elements with shoot-em-up action, to come up with *Special Forces*.

The gameplay is based on a team of elite soldiers, who must take on a series of special missions for the government. The 16 missions are set in four terrains – tropical forests, deserts, arctic areas and temperate zones. Each terrain refers to an overall mission, with four main objectives to be carried out.

Each member of your team can be individually kitted out with weaponry to suit the mission and their fighting specialities.



Special Forces

After selecting your four-man team and mission, you can kit out each member with a selection of weaponry, including automatic weapons, rifles, handguns, grenades, rocket-launchers and laser target designators. Some missions require a certain amount of particular weapons (such as explosives for destroying bridges, or target designators for a planned air strike), but to begin with you just have to make sure that you've got enough firepower to blast anyone that comes in your way.

The missions themselves are carried out by operating two main screens - the warzone view and the scaled terrain map. The warzone view is the main game screen, where you control movement and firing as well as selecting weaponry, planting explosives and collecting objects. The scaled terrain map is where the tactical side comes in. As well as moving team members around the map, you can set formations and waypoints to designate the movement patterns of each soldier. This helps to keep your team moving as a coherent unit, making it easier to attack installations and protect your team members.

At the end of each mission, you are given a report of how well you did, along with a list of members lost or killed in action. If any of your team go MIA (missing in action) you have to re-enter the area and try to rescue them from the enemy troops. After a successful mission, you are given the choice of promoting or decorating any team members, as a reward for exceptional performance in the field.

Tactical neural implant

The method of control in the combat sections of *Special Forces* tries to make you use your brain to work out the tactics, and it would indeed have made the game something rather special... if it worked properly! Unfortunately, when one of your team hits an obstacle or notices an enemy that he can take out, he will wander off from the rest of the team. This wouldn't be too bad if he could find his way



At the end of each mission, surviving members can be rewarded with medals or promotions.

back, but more often than not, you have to locate him on the map and steer him back to the rest of the group yourself. When the rest of the team does behave itself, the gameplay takes another twist, mainly due to the fact that you don't have to actually do any fighting for yourself - the rest of the team do it for you.

Force or farce

This is all very well when you're handling mission objectives, but it makes the levels less challenging when in a fire-fight. Admittedly, you could take on the game at the higher levels to make locating your objectives and battling the enemy a little more challenging, but this doesn't really make the rest of the game run any more smoothly and the feeling of involvement isn't raised by much of a degree.

You can define your battle tactics using the Scaled Terrain Map, setting formations and waypoints for squad members.



A night mission in the Temperate zone calls for the use of hi-tech night-vision goggles.

Special Forces is a brave attempt to try and create something new in the field of combat simulations, but there are just too many problems to make it a classic. The graphics and presentation are quite involved and nicely designed, but where it falls down is in the gameplay itself. There are too many fiddly sections to make the game an enjoyable arcade game and not enough depth to allow it to stand up as a strategy game. A near miss, but at this price it's a miss all the same.

Maff Evans

Special Forces
MicroProse ■ £34.99

- Nicely drawn and varied combat graphics spanning four types of terrain.
- Some annoying control quirks and a few long delays make controlling your team difficult at times.
- An attempt at tactical play has been included but it's still a little shallow for serious strategists.
- Could prove an involving game for children, but won't hold much interest for the hardened combat freak, especially at 35 quid.

AMIGA
Verdict **79%**
 FORMATE

Amiga Peripherals at Perfect Prices...

AMIGA 600 RANGE...

'The new addition'

That's right the Amiga Family has just grown! Not only can you purchase the A500 Plus Cartoon Classics Pack, but now, you have a choice of two innovative Amiga 600 models too... with or without a Hard Disk Drive built-in!

Both models carry Commodore's comprehensive new 'In-Home' Warranty Plan, unrivalled by any other home computer. There's a telephone Help Line to assist you with those minor problems, and on the rare occasion of something more serious, you'll be pleased to know that an engineer will make a call to your home to affect a speedy repair or even replace the unit completely!

How's that for your total 'peace of mind'?



AMIGA 600 AMIGA 600-HD

3.5" Floppy Disk Drive & Free Software.

3.5" Floppy Disk Drive & 20Mb. Hard Drive.

Because the 600 range is so new... the details given have all yet to be finalised completely. By the time this magazine is on sale we are likely to be in the position of confirming with more detail.

Specifications as we know at the time of going to press: New Compact Design, Kickstart/Workbench 2.05, 3.5" Internal 880K Floppy Disk Drive, Built-in TV Modulator, 20Mb. Hard Disk Drive [2.5" fitted to A600-HD model only], 1Mb RAM as standard with an option to upgrade very simply to 2Mb. with RAM expansion in 'trapdoor', 2 Joystick/Mouse ports, Full Colour Composite Video output, 'Smart Card' slot [allows games on ROM to be loaded instantly... no more waiting! And... possible future upgrade port [eg. RAM cards etc], 4096 Colours, Stereo Sound, Standard Parallel and Serial ports for printers etc.

GIVE US A CALL NOW FOR A GREAT NEW DEAL ON A GREAT NEW AMIGA!

A670 CD-ROM DRIVE...

Available Soon!

Allows you to load and play CDTV software on the new Amiga 600 and 600-HD computers. New Interactive Multimedia on your new Amiga!!!

Plus... you can play your favourite music CD Discs [and CD+G discs] too!



Give us a call soon for further news about the equivalent planned CD-ROM drives for Amiga 500 and Plus computers.

AMIGA A500 PLUS PACK...



AMIGA 1Mb 500 PLUS CARTOON CLASSIC PACKAGE INCLUDING ALL THE FOLLOWING...

NEW Amiga 500 PLUS Keyboard with 1Mb RAM and a 1Mb 3.5" Disk Drive, Mouse, TV Modulator, Leads, Manuals, Workbench Disks/Manuals etc. and featuring... 4096 Colours, Digital Stereo Sound, Multi Tasking, Speech Synthesis and more!

THE SIMPSONS
CAPTAIN PLANET
LEMMINGS
DELUXE PAINT III

LOWEST EVER PHONE NOW!

BUT ONLY WHILST LIMITED STOCKS LAST!

star	No. Pins	DPI	SPEED	No. Fonts	Columns	
LC 20 Mono	9	240	150/38	8	4	80 £139.99
LC 200 Colour	9	240	185/40	8	16	80 £199.99
LC 24-20 Mono	24	360	230/75	10	16	80 £209.99
LC 24-200 Mono	24	360	220/55	10	7	80 £229.99
LC 24-200 Colour	24	360	220/55	10	30	80 £269.99
XB 24-200 Col	24	360	275/80	18	29	80 £379.99
XB 24-250 Col	24	360	275/80	18	76	136 £454.99

CITIZEN	No. Pins	DPI	SPEED	No. Fonts	Columns	
120D+ Mono	9	240	120/25	2	4	80 £139.99
SWIFT 9 Mono	9	240	160/40	4	8	80 £189.99
SWIFT 9 Colour	9	240	160/40	4	8	80 £219.99
224 Mono	24	360	160/53	4	8	80 £219.99
224 Colour	24	360	160/53	4	8	80 £249.99
SWIFT 24E Mono	24	360	180/60	7	8	80 £279.99
SWIFT 24E Colour	24	360	180/60	7	8	80 £279.99

star	OTHER TYPES OF PRINTERS	CITIZEN
STAR SJ 48 STARJET PRINTER		£239.99
Near silent Inkjet Printer similar to BJ10e but with Epson LQ/IBM Proprietary emulations. 360dpi. 100cps. 28K Buffer.		£269.99
CITIZEN PN48 NOTEBOOK PRINTER		£749.99
STAR LASERPRINTER 4		£1069.99
STAR LASERPRINTER 4 STARSRIPT		£1069.99
Postscript compatible laser printer... Brilliant Quality Print!		

star	GENUINE RIBBONS	CITIZEN
Star LC10/20	£4.75	£19.95
Star LC200	£6.49	£29.95
Star LC 24/200	£6.99	£32.99
Star XB Printers	£4.99	£22.95
120D+/Swift9	£4.99	£22.95
124D/Swift24	-	£16.45
Swift9/24/224/24E	-	£76.95

star	GENUINE ACCESSORIES	CITIZEN
Printer	LC10/20/200	LC24-200
Sht Feeder	£69.99	£69.99
Buffer U/G	N/A	£32.99
Font Cards	N/A	£27.99
120D+ Cut Sheet Feeder	£74.99	£74.99
124D, Swift 9/24 Semi-auto Sht. Feeder	£44.99	£44.99
124D, Swift 9/24 Auto-Sheet Feeder	£94.99	£94.99
124D, Swift 9/24 Printer Stand	£24.99	£24.99
124D, Swift 24 - 32K RAM Expansion	£13.99	£13.99
Font Cards Swift 24 (6 Different Sorts)	£39.99	£39.99

CITIZEN	CITIZEN STARTER PACK
200 - Sheets of Continuous Paper, 5 - Continuous Envelopes, 100 - Cont. Address Labels, 1 - Amiga/Atari ST Printer Driver 3.5" Diskette	£9.99
	when purchased with a Citizen Printer (£17.95 if purchased separately)

PRINTER FREEBIES...

WHEN YOU BUY YOUR PRINTER FROM MERLIN, YOU ALSO GET ITEMS WE THINK ARE ESSENTIAL... ABSOLUTELY FREE! CHECK OUR COMPETITORS' OFFERS & MAKE SURE YOU GET THE SAME WHEN COMPARING PRICES!

WITH EVERY PRINTER (EXCEPT THOSE MARKED WITH AN (♦)) YOU WILL GET THE FOLLOWING INCLUDED FREE OF CHARGE...

QUALITY DUST COVER
2 PART PRINTER STAND
LEAD TO YOUR AMIGA

(printers marked [v] get all the same FREE items EXCEPT a dust cover)

GVP Hard Disk Drives, Memory Upgrades & Accessories

GVP's Amiga hard drives have a reputation for quality and reliability with an excellent specification. Simply plugs into your Amiga A500 or 500 Plus side port. GVP Hard Drives can be supplied unpopulated or populated to 2Mb, 4Mb, or 8Mb using a combination of plug-in SIMMS memory chips.

- * AMIGA A500 GVP HARD DRIVES...
 - GVP 52Mb. Std Unpop. NEW LOW... £344.99
 - GVP 105Mb. Std Unpop. NEW LOW... £474.99
 - GVP 120Mb. Std Unpop. NEW LOW... £724.99
- * AMIGA A1500 GVP HARD DRIVES [Internal]
 - GVP 52Mb. Std Unpop. NEW LOW... £284.99
 - GVP 120Mb. Std Unpop. NEW LOW... £414.99
 - GVP 240Mb. Std Unpop. NEW LOW... £634.99
 - GVP 420Mb. Std Unpop. NEW LOW... £1164.99

GVP HARD DRIVES POPULATION [RAM u/g]

- Population to 2Mb (2x1Mb SIMMS) £69.99
- Population to 4Mb (4x1Mb SIMMS) £139.98
- Population to 8Mb (2x4Mb SIMMS) £299.99

GVP PC EMULATOR FOR AMIGA's

Fits internal mini-slot of GVP Series II Hard Drives. Includes 16MHz 286 CPU and is compatible with MS DOS 3.2 or later. Runs lots of DOS applications software including Windows... £269.99

GVP DIGITAL SOUND STUDIO

Fits the Amiga A500/1500/2000/3000 range. High quality 8-bit sampler with stereo inputs & variable recording level. Up to 51000 samples/sec in stereo. Plugs into the Amigas parallel port. Special effects include echo, mix, re-sample, filter, and more! 4-Track sequencing & Midi support. Save in IFF, RAW or SONIX formats. Create SoundTracker files or stand alone song files to play separately from DSS. Full 150 page user manual. £59.99

GVP 1500/2000 ACCELERATORS

These accelerator boards fit the Amiga 1500/2000 range.

- G-Force 030-25MHz + 1Mb £579.99
- G-Force 030-40MHz + 4Mb £949.99
- G-Force 030-50MHz + 4Mb £1349.99

AMIGA SUNDRIES

- MOUSE MAT High quality, save your mouse from dirt! £3.95
- DUST COVER HIGH QUALITY vinyl covers for hardware... £5.95
- Amiga keyboard, printers, monitors etc. etc. each
- DISK STORAGE BOXES High quality, smoked perspex lid fully lockable, complete with dividers in two capacities... £6.99
- 40 CAPACITY 3.5" Disks £4.99
- 80 CAPACITY 3.5" Disks £6.99
- DISK LIBRARY CASES Plastic case for 10 disks, 3.5" £0.99
- PRINTER STANDS 2 Part plastic, paper fits under. £9.99
- MERLIN WIZARD STICK Great quality microswitched joystick, robust & longlife, superb control. Other joysticks to be had! £9.99
- AMIGA 500 CONTROL CENTRES From £19.95
- Metal stands for K/Board, Monitor, 2 Disk Drives.
- NAKSHA SCANNER The one you've been waiting for! £109.99
- NAKSHA MOUSE+Free Operation Stealth while stocks last £29.99
- SQUIK MOUSE Budget priced... but GREAT quality £16.95
- AMIGA SOFTWARE... Games, Educational and Business software is always available at discounted prices please phone & ask for prices.
- AMIGA BOOKS... Covering everything Amiga! Phone for details
- PEN PAL W.P. £79.99 (or just £59.99 if bought with h/w)
- WORDWORTH... W.P. packed with features £99.99
- SUPERBASE PERSONAL 2... Brilliant Database at a VERY SPECIAL PRICE only from Merlin... £29.99

PLUS LOTS OF OTHER ACCESSORIES TOO MANY TO LIST!!!

REMEMBER...

The computer equipment at REALLY competitive prices.



Commodore AMIGA 1500's

BRAND NEW 1500 Pack - Ideal for both home and business!!!

Central Processing Unit (CPU) - 1Mb. RAM, 2 x 3.5" Floppy Disk Drives, 8 Expansion Slots to take all Amiga 2000 Peripherals. Keyboard and Mouse... With Numeric Key Pad, 4 Cursor Keys, 2 Button Amiga Mouse.

Plus some great New Software: THE WORKS PLATINUM EDITION: Word Processor, Spreadsheet, & Database. DELUXE PAINT III - 'Web Animation'. HOME ACCOUNTS - Easy Banking & home finance organizer. ELF - A Game of Magic. SUPER!!! PUZZNIK - Addictive puzzle game!!! TOKI - 300 screens of animated fun! GET THE MOST OUT OF YOUR AMIGA! Brilliant reference book for your Amiga.

NEW VERSION WITH ROM 2.04

- AMIGA 1500 CPU KEYBOARD (As detailed) £549.99
- AMIGA 1500 (As detailed) + 1084S Monitor £814.99
- AMIGA 1500 (As detailed) + CM8833-II £779.99

PHILIPS CM8833-II COLOUR MONITOR

14" Stereo Colour Monitor with Green Screen Switch AND... Wide 120dots/cm dot pitch maintenance Great Value... £234.99

Monitor Dust Cover £5.95
AV7300 TV Tuner £79.95
Cable Monitor Stand £12.95

PHILIPS Tri-Swivel Stands...
• CM8833 MkII £14.95
• CM8833 MkII £14.95

FREE... Dust Cover and Lead to your Amiga... from Merlin

PHILIPS TELEVISION MONITORS

A great alternative to a dedicated monitor that allows you to watch TV programmes too!

BRAND NEW PHILIPS RANGE OF TV SETS WITH ALMOST MONITOR QUALITY OF OUTPUT TOO! CHOOSE FROM THREE MODELS... All with superb quality reproduction when used as a monitor or TV! 2000 Character High Definition FST specifically designed for use as both a high quality TV and a monitor. Full two year warranty!!!

- PHILIPS 3312 - 15" remote control with sleep timer £239.95
- PHILIPS 2331 - 15" spec as 3312 but with Teletext £279.95
- PHILIPS 2341 - 17" version of the 2331 with Teletext £339.95

Take £10 off if bought with other hardware

OTHER TV'S AND MONITORS

All of the monitors and TV monitors below are supplied with the necessary leads to your Amiga. Remember dedicated monitors give a better quality output from your computer but TV Monitors are far better than normal domestic TV sets.

- COMMODORE 1084S COLOUR MONITOR £269.99
- PROSTAR 'VISTO' MONITOR, Based on Philips' CM8833 £279.99
- GOLDSTAR TV MONITOR, A real alternative to dedicated monitors which gives you normal TV as well!!! £199.99

AMIGA SECOND DISK DRIVES

INCREASE YOUR AMIGAS PERFORMANCE...

- MERLIN 3.5" DISK DRIVE 3.5" Second Disk Drive, Enable/Disable Switch, Slim Design, 800K Formatted Capacity. No external power supply is needed. Through-port. THIS IS ONE OF OUR BEST SELLERS! £56.99
- ROCKLITE 3.5" DISK DRIVE, ULTRA SLIM & LIGHT. Ivory to match your Amiga - CDTV compatible too! £64.99
- COMMODORE 1011 3.5" 2nd DRIVE £79.99
- CUMANA 3.5" CAX 354 DRIVE Enable/Disable switch, Throughport, Extra Long Cable. £79.99

AMIGA UPGRADES

Increase the power of your Amiga quickly & easily!

- 1Mb. Memory Upgrade for Amiga A500 Plus £44.99
- Simply fits in the trapdoor of your Amiga [Just £30.99 with an Amiga ROM SHARER FOR ALL 500'S AND PLUS AMIGAS £22.99
- Requires fitting internally and hence invalidates Amiga warranties. Allows you to use either of the following ROM chip sets to change o/s.
- Version 1.3 Chips £29.99
- Commodore A501 0.5Mb. RAM Upgrade for A500 Amigas £49.99
- TecnoPlus 0.5Mb. RAM Upgrade for A500 [1.3] Amigas £49.99
- Commodore Version 2 Kickstart/Workbench Upgrade Pack £79.99
- with Workbench Extras/Fonts disks & Manuals

MERLIN EXPRESS LIMITED
DEPT. UNIT C7, THE ROPEWALK IND. CENTRE,
STATION ROAD, ILKESTON, DERBYSHIRE. DE7 5HX.

SWITCH VISA

0602 441442

The Amiga Format Collection Power up!

If you're enjoying using one of the fabulous **Amiga Format Collection** programs, there's no need to stop there! Get even more value and even more use by investing a small sum in one of these remarkable upgrade offers!

Spectracolor Jr to Spectracolor

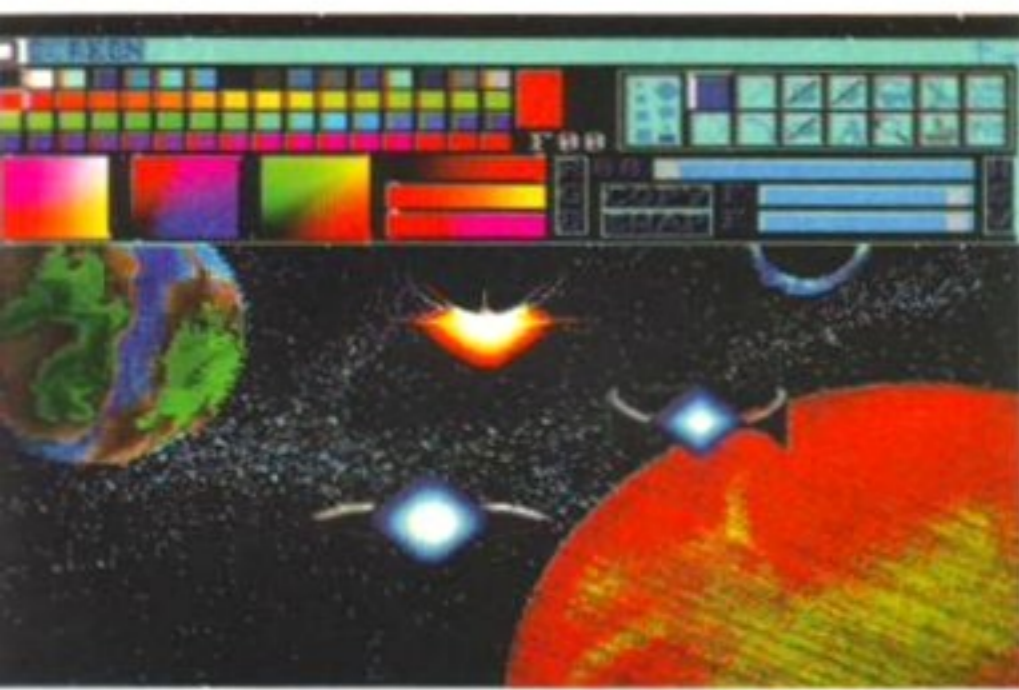

£29.99*

Once you've had chance to experiment, and discovered artistic talents you never realised you had, with this month's Coverdisk, you'll believe that *Spectracolor Jr* is a very easy-to-use paint program. And if it's whetted your appetite, selecting from 4,096 possible HAM colours, it doesn't have to stop there. **Amiga Format** have negotiated a very special offer for readers who want to get hold of *Spectracolor's* advanced features. The full featured upgrade includes the following innovations:

BRUSH WRAPS • ADVANCED PAINT MODES • AIR BRUSH • BRUSH ANIMATION – INCLUDING CURVED PATH ANIMATION WITH FADES AND SIMPLE MORPHING.

But the upgrade doesn't stop there. You'll receive a program disk, plus a sample tutorial disk and an in-depth 300-page manual that will take you through countless examples and techniques showing you precisely why *Spectracolor* is such an excellent paint-and-animation package.

PageSetter 1.2 to PageSetter 2



£49.99*

Once you've begun to master the art of DTP, you may want to take a step up towards the big league! *PageSetter 2* is Gold Disk's simple step on but provides considerably more power than its younger brother, because it's written in full assembly language for speed and efficiency. It includes many more powerful features, but never fear that you will be left in the dark because it comes with a full manual. Features include:

USES COMPUGRAPHIC OUTLINE FONTS FOR PROFESSIONAL TYPE • ON-PAGE TEXT EDITING • VARIABLE FONT FILL PATTERNS • IFF AND CLIP PICTURE SUPPORT

**ORDER DIRECT FROM OUR
MAIL ORDER HOTLINE BY
DIALLING 0458 74011 TODAY!**

*PLUS £1.45 TO COVER POSTAGE AND PACKING

More Merlin Magic...



A NEW MEDIA REVOLUTION...

You get... THE NEW CDTV PLAYER with full infra red remote control plus leads to TV and audio system and an introductory "welcome disc" plus Lemmings and Hitchhiker's Encyclopedia all on Compact Disc!!!

...BUT THEN MERLIN WILL INCLUDE ABSOLUTELY FREE OF CHARGE EITHER... An 88 Key QWERTY Keyboard Worth £49.95! OR A 3.5" Floppy Disk Drive Worth £59.95!

Only... **£499.99**

A range of CDTV accessories are now coming on line, please phone to check availability.

CDTV KEYBOARD	88 Key QWERTY, plugs into the CDTV.	£49.95
CDTV MOUSE	Two way infrared remote control, includes battery saver feature.	£39.95
CDTV TRACKBALL	Infrared remote control with sockets for two standard joysticks or standard mouse.	£79.95
CDTV 3.5" DRIVE	Allows loading of compatible Amiga software. Rack mountable. 880K capacity.	£99.95
ROCLITE 3.5" DRIVE	CDTV compatible in matching black.	£67.95



Makes 'child's play of programming your video and satellite

- Switches on your video automatically at the right time
 - Sets the TV or satellite channel to record
 - Sets the start time of the programme
 - Sets the length of recording required
 - Records the programme then shuts your system down
- ALL THIS FROM TYPING IN JUST ONE SET OF NUMBERS! [You know those funny little numbers you've seen in TV Times and most national newspapers and TV guides].
- Pre-Set up to 14 different programmes to record
 - VideoPlus is supplied with... *All for just...* Batteries fitted (and the unit set to the correct time, date etc) **£59.99**
 - Full user manuals and instructions.
 - Watch & Wipe tutorial Video with Michaela Strachan.

MERLIN SORCERORS PACKS

AMIGA STARTER PACK	Mouse Mat, Dust Cover, Ten Blank Disks in a Plastic Library Case, Good Quality Joystick...	£19.99
AMIGA 10 GAMES PACK	Datascorn, Dungeon Quest, E-Motion, Kid Gloves, Grand Monster Slam, Powerplay, RVF Honda, Shuffle Pack Cafe, Microprose Soccer and Tower of Babel	£24.99
AMIGA 15 GAMES PACK	As above but also... Skidoo, Casino Roulette, Saint & Greaviss, 20000 Leagues and Table Tennis	£34.99
COMPENDIUM SIX EDUCATIONAL PACK	For 4-12 year old children. Kids Type, Calendar Quiz, Weather Watcher, Words & Numbers, Game Set & Match and What is it? Where is it?	£29.99

NOTE: the above prices are based on purchasing WITH an Amiga



Great quality Amiga Hard Drives from the Protar range and backed by either a 1 year or 2 year REPLACEMENT warranty direct from the manufacturers!

A500 HD20	£279	A500 HD100DC*	£599
A500 HD40	£349	A500 HD160DC*	£939
A500 HD50	£369	Memory Upgrades...	
A500 HD50DC*	£399	1Mb	£58, 2Mb, £116
A500 HD80	£599	4Mb	£248, 8Mb, £496

(* = 2 Year Replacement!)

FREE ENTRY INTO THE MERLIN EURO DISNEY PRIZE DRAW

With each hardware purchase you will receive a FREE ENTRY form* for our Euro Disney Holiday Competition.

*Full Details available on written request to Merlin Express Ltd. Please include a SAE.

Euro Disney ©Euro Disney is the Copyright of The Walt Disney Corporation

ORDERING

Just telephone our 24 Hour Order Hotline using your Access/Visa or Switch Cards, or send a cheque/postal order with your requirement details, delivery address & daytime telephone number (cheques need clearance unless issued by a Bank Building Society for you)

DELIVERY

Small items are despatched by post to all UK Mainland addresses for a nominal fee, unless otherwise discussed. Hardware is despatched by courier service (up to 25kg) as follows: NEXT WORKING DAY... add £7.50 to order, TWO WORKING DAYS... add £6, or for SPECIAL SATURDAY DELIVERY... add just £12 (Please note courier service applies to MOST UK Mainland addresses)

WARRANTY

Hardware proving faulty within 30 days will be exchanged for NEW (subject to condition etc). After 30 days and within 12 months from purchase, faults will be rectified by the relevant manufacturers' repair agent and returned to you by courier. Software and small items carry various warranties, just ask for details

COLLECTION

Merlin Express Limited are predominantly a mail order company, but we always welcome customers to our trade/collection counter who wish to pick up goods from us. Why not pay as a visit, we'll be pleased to help you with your enquiries

BFPO & EXPORT

Merlin are happy to supply BFPO and export markets for which VAT is normally deductible. Delivery charges vary from UK rates and, as products carry UK warranties only, faulty items are to be returned to Merlin by customers & re-delivery charges will apply

PLEASE NOTE...

Whilst every effort is made to ensure information in this advert is correct, you should always confirm any offers, prices, availability etc, prior to placing your order. We endeavour to supply goods as shown and will ONLY change details should it be made necessary by our suppliers etc. As our advertising is booked so far in advance Merlin therefore reserve the right to alter product specs, withdraw any product/offers/service or update prices (and that can be up OR down) without prior notice. Merlin guarantee never to supply anything that has been subject to change without you, the customer, being informed of and agreeing that change. Please ALWAYS confirm details PRIOR to placing your order. All our currently advertised offers supersede previously advertised offers and goods are NOT supplied on a trial basis. EA0E

VALUE ADDED TAX

All of Merlin's listed prices are inclusive of VAT at 17.5% (please check that other companies do the same when comparing prices). If goods are for export or BFPO addresses they will normally exempt VAT. To calculate the price simply divide the price shown by 1.175. (Advertised price of £235.00 - Divide by 1.175 to give an EX-VAT price of £200.00 sterling)



MERLIN EXPRESS LIMITED
DEPT. AMF, UNIT C7, ROPEWALK INDUSTRIAL CENTRE,
STATION ROAD, ILKESTON, DERBYSHIRE. DE7 5HX.



24 HOUR ORDER LINE ☎ 0602 441442 ☎

BCS SUMMER SALE

LOOKING FOR DISKS & BOXES
LOOK NO FURTHER

DISKS ! DISKS ! DISKS !

100% CERTIFIED ERROR FREE

50	3.5" DS/DD	£22.50
100	3.5" DS/DD	£37.00
150	3.5" DS/DD	£52.50
200	3.5" DS/DD	£69.00
400	3.5" DS/DD	£138.00
500	3.5" DS/DD	£165.00
1000	+ Call for spot price	

All prices include VAT / free labels
& free delivery

DISKS + 100 CAP LOCKABLE BOXES

100% CERTIFIED ERROR FREE

50	3.5" DS/DD + 100 cap box	£25.50
100	3.5" DS/DD + 100 cap box	£40.50
150	3.5" DS/DD + 100 cap box	£56.50
200	3.5" DS/DD + 2 100 cap boxes	£74.00
400	3.5" DS/DD + 4 100 cap boxes	£147.00
500	3.5" DS/DD + 5 100 cap boxes	£174.00
1000	3.5" DS/DD + 10 100 cap boxes	£ call

All prices include VAT / free labels

3.5" DELUXE LOCKABLE BOXES

40 Capacity	£4.10
100 Capacity	£4.50

3.5" STACKABLE BOXES

60 Capacity Lockable	£10.00
80 Capacity Banx Lockable Box	£8.95
150 Capacity Posso Box	£15.00

3.5"/5.25" 10 CAPACITY BOX £1.00

5.25" 50 Cap Lockable	£5.10
5.25" 100 Cap Lockable	£5.90
5.25" 70 Cap Posso Box	£16.50

NEW A600 £369

NEW A600 PLUS 20Mb HD £459

DISKS + BANX STORAGE BOXES

100% CERTIFIED ERROR FREE

50	3.5" DS/DD + 80 Cap Banx Box	£31.00
100	3.5" DS/DD + 80 Cap Banx Box	£45.00
150	3.5" DS/DD + 2 x 80 Cap Banx Boxes	£68.00
200	3.5" DS/DD + 2 x 80 Cap Banx Boxes	£85.00
500	3.5" DS/DD + 5 x 80 Cap Banx Boxes	£199.00

All prices include VAT/ Free labels & free delivery

A500 PLUS 1Mb CARTOON CLASSIC PACK £335

Philips CM8833 Mk II Colour Monitor
UK Spec, lead + F19 Flight Simulator +
1 year on-site warranty
ONLY £228

CDTV
£445

PRINTER STAND
£6

HIGH DENSITY 3.5" DISK 60P EACH
(OR 100 3.5" DS/HD FOR £61 INCL. P & P /
LABELS/VAT)

5.25" DS/DD Disks21p each
5.25" DS/HD Disks39p each

AMIGA EXT CUMANA DRIVE £58

14" MONITOR STAND (TILT & SWIVEL) £10.00

AMIGA 1500 ONLY £575

ACCESSORIES

1/2 Meg Upgrade	£27.00
1/2 Meg Upgrade + Clock	£29.00
1000 Labels (coloured)	£8.00
1000 Tractor Labels (white)	£10.00
Amiga Mouse	£14.00
Mouse Mat	£2.75
Mouse Holder	£2.50
1MB Upgrade (A500P)	£55.00
Amiga Dust Cover	£5.00

JOYSTICKS

Zipstick	£11.50
Stingray Joystick	£13.50
Cheetah 125+	£7.50
Cheetah Star Probe	£10.00
JetFighter	£12.50
Topstar	£21.00
Manta Ray	£13.50
Black Cruiser	£10.00

LOOK COLOUR PRINTERS

Star LC-200	£205.00
Star LC-24 200	£265.00

Prices incl. VAT/lead

GVP 52 Mb HD £359

**BEWARE, BEWARE, DUE TO MASSIVE DISK SHORTAGES STOCKS ARE SHORT IN THE U.K. B.C.S. HAS STOCK .
DON'T DELAY ORDER TODAY !**

All prices include VAT. Add £4 P&P / add £8 2 day / £10 next day
Call in or send cheques / postal orders to:

BCS Ltd., 349 Ditchling Road, Brighton, East Sussex BN1 6JJ

ORDER HOTLINE:

Tel 0273 506269 or 0831 279084

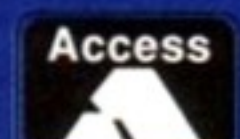

All offers subject to availability. Prices may change without notice.

Ever since the two guys from Andromeda discovered and pounced upon galactic dustman Roger Wilco, he hasn't had a minute to himself. Dragged from his mortally-safe and boring freighter-cleaning routine into conspiracies beyond Captain Kirk's wildest imagination, Roger now just wants to wind down. Hoping to use his fourth graphic adventure to return to his home planet, Xenon, for a foam bath and some good company, Roger finds his plans thwarted yet again. Sierra's cult game designers Mark Crowe and Scott Murphy relentlessly thrust him into an odyssey through time and space...

Into the time warp

A year after its spectacular appearance on the PC, *Space Quest IV: Roger Wilco and the*

Not quite the Millennium Falcon, Wilco's craft is a bit of a bucket. It flies, as you'd expect, but the headlamp aim is a bit off. You can never find a good space-garage when you need one.



Space Quest IV: Roger Wilco and the Time Rippers



Loitering on street corners has never been a good idea, and things are no different in the future. The best advice here is: run, run and run again!

Time Rippers is now ready to land on the Amiga. Keyboard fans have succumbed to the admittedly easy-to-use, point-and-click interface. Few will miss the sparkingly witty exchanges with the parser. An icon bar across the top of the screen shows all the possible modes and menus, chosen by right mouse clicks and executed by left ones. You can walk, talk, examine or manipulate objects. The inventory is pictorial, too, unlike the smug messages you get after meeting your untimely demise – gently hinting at what might have convinced fate to turn at the doorstep.

Where does our involuntary hero set out, then? On his way home to *Xenon*, arch-rival and ultimate baddie Vohaul (of earlier sequels' fame) has unsuspecting Roger caught and, very nearly executed. Only nearly, as members of a resistance force are at hand to wrest our hero from the killers' iron grip. With encouraging comments, they shove him through a time rip – straight into *Space Quest XII: Vohaul's Revenge II*. *Xenon* seems to have taken too much of a megablast sometime in the future. Eerie ruins and paranoid androids welcome Roger to (or, the in case of the androids, out of) this brave new world. Soon, however, entrances to the glitzy underworld

are found. A fast and furious race against time, the infamous Sequel Police and a lot of ill-mannered aliens ensues. Will you be able to rescue Roger from the unforgiving Vohaul? Will the pink rabbit be caught and the latex babes of Estros successfully visited?

Almost certainly so. While the beautifully absurd encounters, puzzles and cross-references send science fiction fans whooping, they will all too soon find that they have solved it all. The past, the future and, more specifically, Roger's life and sanity do not even take beginners long to restore. Hardly a headache is caused by the trials and tribulations of our hero. While the story amuses, but leaves seasoned players dissatisfied, the listless conversion of sound and graphics does injustice to the Amiga. Admittedly, metallic minimalism has a certain sci-fi appeal that might be lost on, say, a *Larry* or *King's Quest* player. Still, there is no excuse. What could decent reprogramming have done to the

Monolith Burger Bar scenes or to the irritably well-stocked software shop (look at some of the games, you'll crack up!). As it were, you'd better turn down the volume, ignore the dreary backdrops and indistinguishable objects as far as possible and get on with the game.

Unlike lovesick Larry, Roger Wilco definitely has all our sympathy. Watch the poor chap stumble from one acid trap into the next huntress poised to strike – girls must simply fall for this innocent (if slightly prone to swaggering) blonde dummy. Yet they must be strong-willed to put up with his deficiencies...

So you want to be a hero

Grit your teeth and hang on to your mouse... or fall asleep while Roger drags himself across the screen. Seven disks provide you with lots of installation time to study the technical manual and the more colourful *Space Piston* magazine. Beginners' tips and something close to Infocom humour temporarily distract from the simple, if wickedly-funny game itself. Asking £35 for an absurdly fat package with less game than even two years ago is simply asking a bit too much. Surely, Sierra can do better than that?

Eva Hoogh

For *Space Quest IV*, Sierra have adopted Monet-style impressionist artwork - a bit odd for sci-fi really.

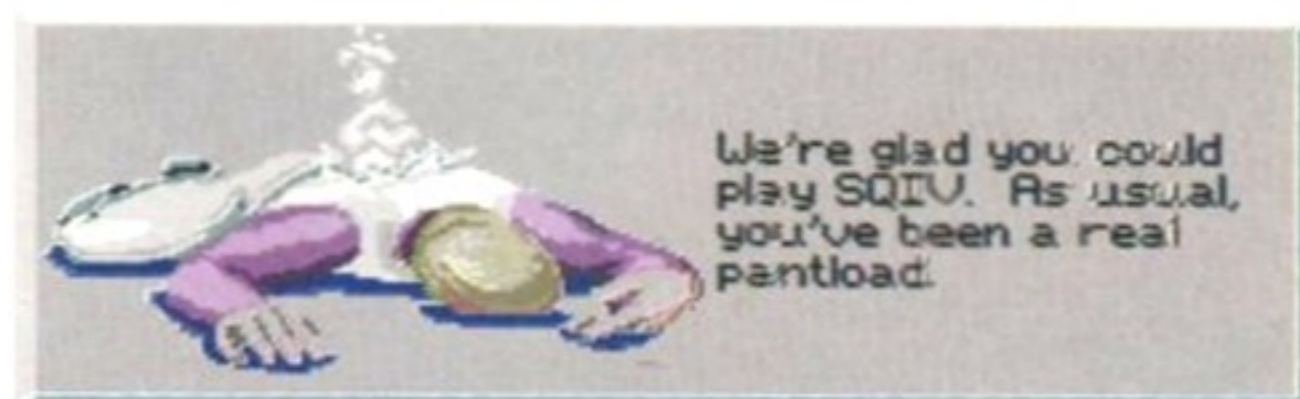

Space Quest IV Sierra ■ £34.99

- Wonderfully warped humour.
- Drab, indistinct graphics.
- Music? Yes, it exists.
- Unacceptably slow motion and reduced animation without a turbo card or an A3000.



48%



No sooner do you leave the peaceful and prosperous town of Phlan than some cat named Lord Bane wipes it out. Life's like that in the rough-and-tumble world of adventuring. It's a laugh though eh? Er, well not if they happen to visit your town it isn't.



This charming lady with the sales technique will obligingly sell you some serious maiming, mashing and generally nasty bits of magic equipment. There are some pretty portraits of characters along the way - all taken from '1,001 Middle Earth Cameos'.



Don't fancy the look of your head? Change it for another. All your character's piccies can be edited and fiddled with, it helps if you can instantly recognise the different members. They are all still crap though.

The world of middle earth, with its gods, legends and magic is a rich and imaginative one. But this game manages to miss out all that and goes straight in for a boring marathon session of fiddly fights. It's a game format as old as the hills and it really should stay there.

A few years ago you might have got away with it, now it just looks very amateur. The graphics add nothing to the atmosphere either. The characters are simple blocky affairs, some of the still pictures are good but otherwise it's not much to look at. Nothing much to listen to either, the whole game is played in silence. Unless you are an AD&D nut and relish the idea of anything that uses the official rules then this effort is a poor introduction to role-player games. Will Lord Bane bring evil and destruction to the land or will the brave adventurers prevail? Couldn't really care less.

Christopher Lloyd

AMIGA FORMAT

Pools of Darkness



62

JUNE 1992

It's a cult thing this *Dungeon and Dragons* lark. Pretending to be some muscle bound axe-wielding bod or a berobed caster of spells and joining like-minded idiots in a group bonding session and ridding middle earth of slimy things and other ethnic groups you disagree with. *Pools of Darkness* is the fourth instalment of such shenanigans and uses the official *Advanced Dungeons and Dragons* rule system. You create and guide six player-characters around Moonsea getting beaten up by strange new monsters. It's a vast game on three disks that needs one meg and is a definite pain in the wrist from all the disk swaps if you haven't got a hard drive to install it on.

The plot from hell

The plot? Well you'd never guess but some evil, nasty, really very mean guy is hell bent on a bit of subjugation and revenge because well, he's just that kind of guy. Luckily there's a group of hardy brave adventurers for whom the idea of a body-mangling match with the forces of darkness holds no fear.

The first step is creating your party. You can import characters from the previous *Secret of the Silver Blades* or generate new ones. They start off tough with heaps of magic weapons. This is high level adventuring - not a Kobold in sight. You can adjust the character graphics, however they all end up looking crap.

You start off in this peaceful city of Phlan. Where you can wander around the town in terrible 3D graphics. If these get too much you can swap to a map mode that thoughtfully leaves out the locations of the doors making it pointless. After a spot of spell memorising and shopping the adventure proper begins.

The ultimate goal is to defeat the three henchmen of Lord Bane, by teaming up with other characters, finding objects and killing - there's a lot of this. In fact the game soon turns into a constant round of battles. The puzzle solving and character interaction is very limited. It's just bash-hack-slash, collect goodies, recuperate and wander off in search of more bashings.

Heroic failure

The game is fought in a series of rounds, you give orders to each of your chaps in turn. They can fire bows, cast spells or just slash about with the old cold steel. The results are figured out and your fighter collapses in a heap or not as the case may be. These sections don't exactly inspire, which is a great pity since it's the largest part of the game. There are no sound effects at all - not even the odd sampled gurgle to add a little something. It's not easy either, great mobs of assorted nasties attack from all sides, so be prepared for a few embarrassing 'party wipeout' situations. Luckily you can save your progress in-between duels.

The main combat screen where all the heavy stuff happens. "Right lads you lot run forward screaming and waving your choppers about and I'll stand around and try to look really hard, OK?" The punch-ups get seriously death-like early on, using each of the character's abilities to the full is the key to successful monster pummelling.



Pools of Darkness

SSI/TSR ■ £30.99

- Tied down by the terrible D&D rule system, using all the restrictive bits and none of the atmosphere.
- Little puzzling and character interaction leaves endless rounds of combat.
- So cringingly full of cliches that it's almost too painful.
- Vast game world will keep you exploring and fighting for quite a while, if you can keep up the interest.
- Doesn't stretch the Amiga's capabilities at all, where does that megabyte go?

Verdict 53%

VOTED THE WORST MOVIE OF ALL TIME...



Screen shots from PC version



WHERE THE STRANGEST THINGS HAPPEN !!

Plan 9 From Outer Space ©1992 Wade Williams Productions, Licensed by Alter Ego Productions

Gremlin Graphics Software Ltd., Carver House, 2-4 Carver Street, Sheffield S1 4FS.



Break new ground in interactive entertainment when you enter the world of Plan 9. You are the private investigator who must assist the legendary **Bela Lugosi**, the original **Vampira** and the totally forgettable **Tor Johnson**, to recover six missing film reels and rebuild the cult movie classic. CONTAINS ACTUAL FILM FOOTAGE TO SPLICE AND EDIT.

IT'S GOT TO BE THE STRANGEST GAME EVER JOE !

YEAH MAC... ...AND... ...SOMEBODY IS RESPONSIBLE

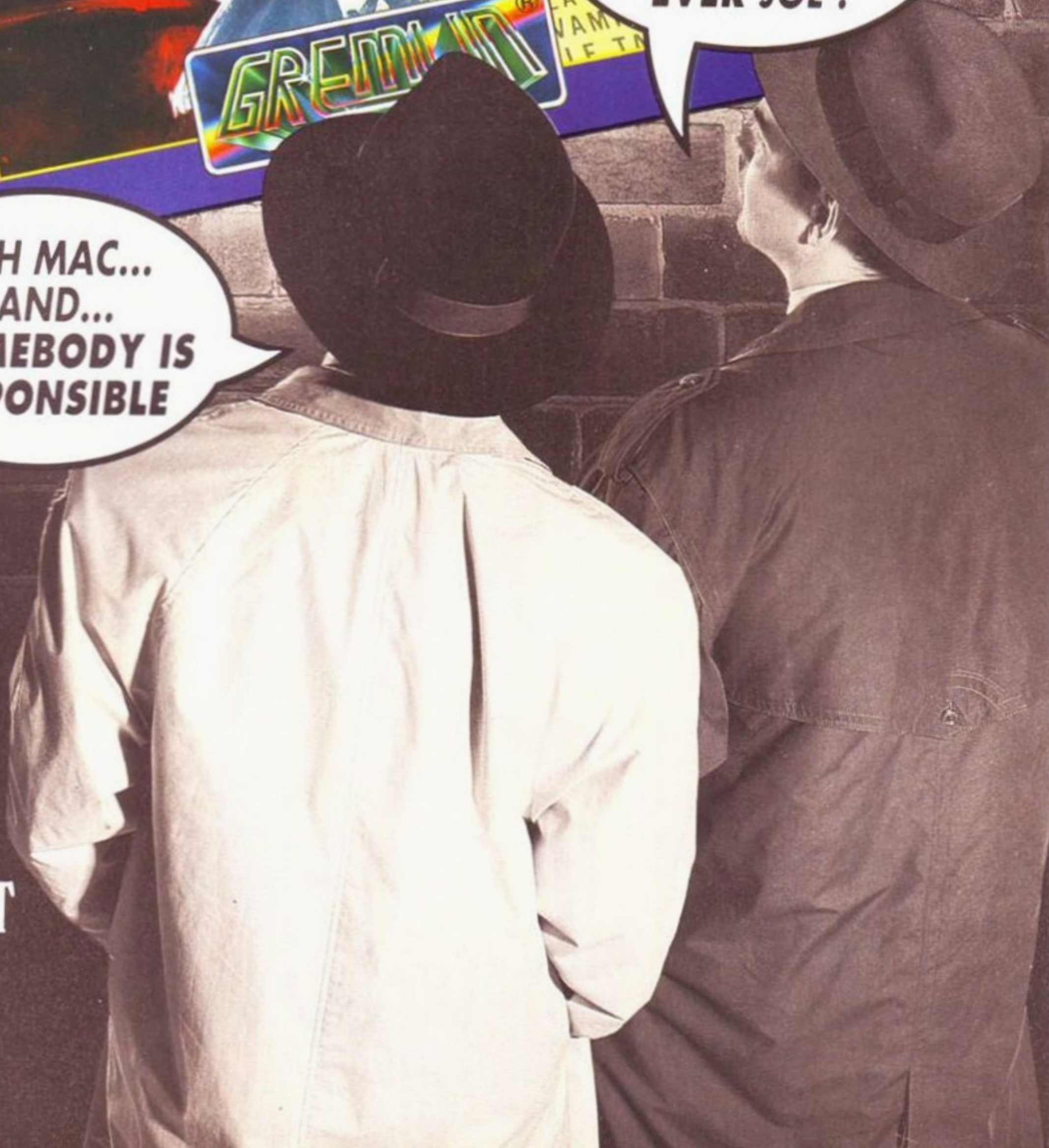

0530 411485

ASHCOM

DESIGN & DEVELOPMENTS LIMITED

0530 411485



PRESENTS
MAC II
BACK-UP



FOR ONLY

£39.95
INC. VAT & P&P

THE MOST POWERFUL SOFTWARE BACKUP SYSTEM EVER PRODUCED FOR THE A500/A500 PLUS
THERE IS NO SOFTWARE YET PRODUCED THAT CANNOT BE BACKED UP USING THE MAC II SYSTEM

FEATURES: ● The most comprehensive back-up utility ever! ● Menu driven options which make it easy to use ● backs up other formats: IBM, Atari etc.
● Quick and easy to install (second drive required) ● Also available for A1500/A2000

ORDER MACII BACK-UP NOW AND YOU WILL NEVER HAVE TO PURCHASE ANOTHER BACK-UP UTILITY AGAIN

ADDAX - ADDHARD

THE ULTIMATE RAM EXPANSION
AMIGA A500/A500PLUS

COMPLETE HARD DRIVE SYSTEM FOR THE
AMIGA A500/A500PLUS

FEATURES

- EXTERNAL FITTING
- JUST PLUGS IN!!!
- AUTO-CONFIGURE FOR 2Mb-4Mb-8Mb
- BUS THROUGH PORT
- ULTRA LOW POWER
- NO EXT PSU REQUIRED
- FULLY BUFFERED ADDR AND DATA BUS
- ZERO WAIT STATES
- GURU FREE!!!
- SLIMLINE CASE
- STYLED TO THE AMIGA
- HIGH DENSITY DRAM
- LATEST TECHNOLOGY
- ALLOWS CREATION OF LARGE & FAST RAM DISKS

WILL NOT INVALIDATE
COMMODORE WARRANTY

**JUST PLUG IN &
AWAY YOU GO!**

- SIMPLE! -



AVAILABLE FOR 1.3/2.04 AMIGA A500 - PLEASE SPECIFY IN ORDERING

OUTSTANDING FEATURES

- VERY HIGH SPEED
- SMALL SLIMLINE UNIT
- VERY LOW NOISE
- NO EXT PSU REQUIRED
- BUS THROUGH PORT
- AUTOBOOT 1.3/2.04
- COLOUR MATCHED
- STYLED TO THE AMIGA
- FACTORY SET
- EASY TO INSTALL!!
- EASY TO USE!!
- WILL NOT INVALIDATE WARRANTY

**HIGH QUALITY
LOW PRICES!**

AX502	2MB	EXP	£119
AX504	4MB	EXP	£175
AX508	8MB	EXP	£289
AX508U	0MB		£79

AX508 RANGE - EASY TO UPGRADE - USES 1MEG*4 ZIP's

ADDHARD45	45MB	£265
ADDHARD70	70MB	£325
ADDHARD105	105MB	£375
ADDHARD205	205MB	£549

ALL HARD DRIVES ARE INC OF VAT & NEXT DAY COURIER

**TAKE YOUR A500 PLUS UP TO 2MB
DESIGNED FOR THE AMIGA A500+ £39**

1.3/2.04 ROM SHARER - ONLY £19.95

KICKSTART ROM 1.3 £34.94 2.04 CALL

**AUTOMATIC MOUSE/
JOYSTICK SWITCHER £14.95 NEW**

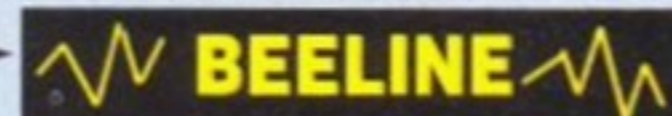

HIGH QUALITY STEREO SAMPLER - FOR THE AMIGA
WORKS WITH ALL KNOWN SAMPLING SOFTWARE
INCLUDES FULL DISK OF SAMPLING SOFTWARE!

£34

CHIP's & SIMM's - 4MEG*9-80NS SIMM £99 1MEG*9-80NS SIMM £29 256K*4 £4 256K*1 £1 SQUIK MOUSE £14.95 ROCTEC EXT SLIMLINE DRIVE £59.95
1 YEAR WARRANTY ON ALL PRODUCTS. ALL PRICES INCLUDE VAT & P/P. ORDERS NORMALLY DESPATCHED IN 24HRS. REGISTERED COMMODORE DEVELOPER.
FOR FURTHER INFORMATION ON ANY PRODUCT PLEASE TELEPHONE OR SEND A S.A.E. TO THE FOLLOWING ADDRESS. TRADE ENQUIRIES WELCOME.

Only from ASHCOM, DEPT AF6, 10 The Green, Ashby-De-La-Zouch, Leicestershire LE6 5JU

MON-FRI 9.00-5.30

Telephone: (0530) 411485 (24hrs) Fax: (0530) 414433

SAT 9.30-4.00

AMIGA

POWER

**MAY ISSUE
OUT NOW!**

INSIDE WE RATE THE

1000

BEST

GAMES

EVER!

THE
MOST
COMPLETE
LISTING
YET!

SPECIAL
30
PAGE FEATURE



AND NEXT MONTH...

REVIEWED: JOHN BARNES, ADDAMS FAMILY, MYTH
AND MORE! ALL THE NEW SOCCER GAMES PREVIEWED!
AND! 2 MORE DISKS, INCLUDING BRILL LEGEND DEMO!

BRITAIN'S
BEST-SELLING
AMIGA GAMES
MAGAZINE



Gomez is being chased by a particularly vicious tree. Baddies don't come much more scheming and blood-thirsty than this, gore fans, so I think it's time to venture inside.

find them. Explore all the big levels (each level is found behind a door in the hallway of Addams Mansion, so you can decide which to negotiate first *Robocod* style), locate and rescue all of the family and your job's done.

Gomez can run and jump, killing his enemies (and there are lots of them) by bouncing on their heads (maybe he's wearing crampons or something – use your imagination). Each level is divided into sub levels by secret passageways, tunnels, underwater sequences and so forth, hence mapping is essential to success. Another useful aid is the assortment of power-ups you find littered about the mansion.

Fish

If the game layout smells a bit fishy (that was a poor *Robocod* gag, sorry) then the power-ups reek of *Sonic The Hedgehog*: power-sneakers to speed-up our little Gomez; sparkling invincibility clouds and dollar icons to collect and then trade for extra lives. Gomez can also collect a flying fez (enabling him to go up, down,

Lurch is playing the piano. As more members of the family are rescued and congregate in the piano room, his tune develops. It's just like the end of the *Sound of Music* in reverse.



loop-the-loop and defy the ground for a few precious seconds) and heart icons to replenish his meagre energy reserves.

The game area is huge, the obstacles that you'll encounter are well thought-out (your success is down to skill, not just blind fire-button pummelling luck) and Gomez moves as smoothly as a ghost.

There's not that much variation in terms of gameplay between the levels and the backgrounds would have added atmosphere, but apart from these niggles *Addams Family* is a good game. There's nothing earth-shattering, ground-breaking or gob-smacking, and despite the obvious similarities, *Addams Family* isn't quite in the same league as *Robocod*. But I enjoyed it, and I'm sure you will too. Let's hear it for good ol' fashioned gameplay.

Neil West

AMIGA FORMAT

66

JUNE 1992

Addams Family

A few months ago, while the *Addams Family* film was mopping up the last of the profits on a tour of the provinces, this cutesie platform explore-em-up was well down the road to completion and had some of the most beautiful background graphics you ever did see. What we have here, however, is the finished version – with no gorgeous backdrops. Have Ocean gone mad? Is graphical devolution the hip thing for programmers to get into these days? Besides, games sell off the back of groovy screenshots don't they?

Well yes, a sexy-looking still from a game can often push a punter's cash till-wards. But Ocean have made a brave move and decided that it's gameplay that counts. Are all the other softies listening?

Eating cakes as opposed to having (!) them

What you can't see on paper (so you'll have to take my word for) is the slick character animation and fast-moving sprites. Gomez (our principle boy) is superbly controllable and scuttles around his *Robocod*-meets-Freddy Kruger world with panache. As a result, *Addams Family* is real fun and has great 'feel'. Ocean felt this level of gameplay was worth the graphical costs, and made the sacrifice.

Keeping faithful to the film's storyline, Uncle Fester has been kidnapped by the evil Abigail Craven (along with most of the other members of the family) and it's your job to



Oh dear, it's all gone horribly wrong. The spiked pendulum of doom got the better of our moustached marvel just as he was down to his last life heart. Lucky he's still got a couple more lives, really.

Now that black, Gomez-sized hole sort of affair at the bottom of the tree trunk is what we (in the trade) would call a secret doorway. Be assured that the rest of them aren't so easily spotted...



Addams Family Ocean ■ £25.99

- *Robocod*-esque characterisation, animation and level design works well.
- Huge play area (with bags of secret rooms and hidden passages) to explore, with a handy password system for skipping levels.
- Gomez leaps, skids and scuttles around his world with dreamy controllability.
- There's even a groovy soundtrack!

AMIGA
Verdict 78%
FORMAT

“It’s clear from this evidence...”

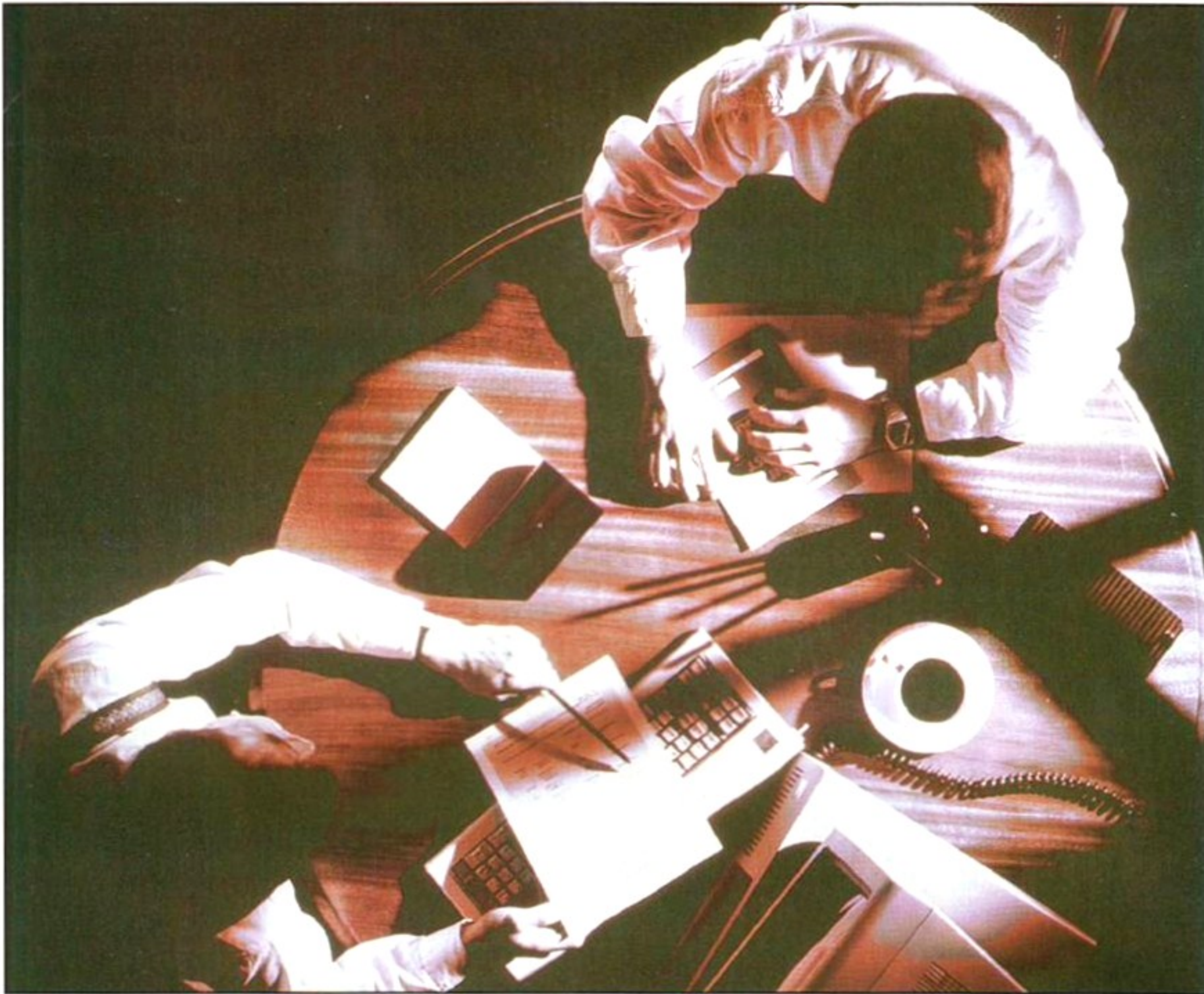

*...that we should be
playing Sid Meier’s Covert Action.”*

*Use your skills in deduction to foil terrorists, spies and
criminals around the world.*

MICRO PROSE™
SIMULATION • SOFTWARE

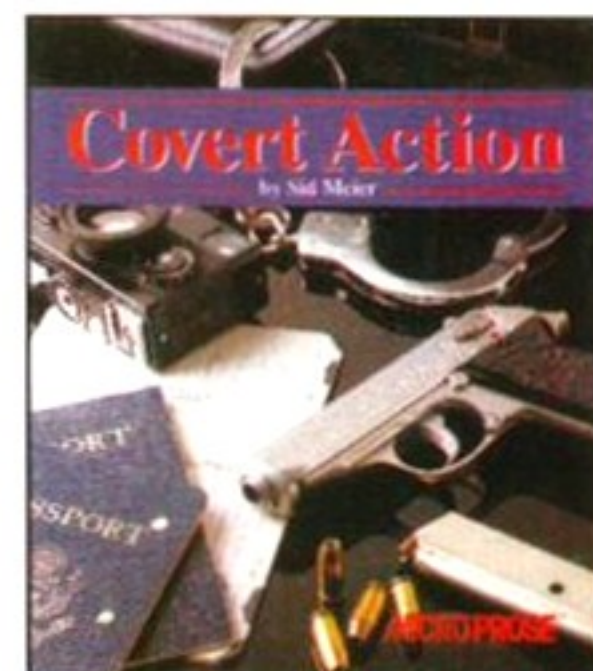

Covert Action, for your IBM PC compatibles, Commodore Amiga and Atari ST
from the creators of **Railroad Tycoon** and **Civilization**. MicroProse Ltd. Unit 1,
Hampton Road Industrial Estate, Tetbury, Glos. GL8 8DA. Tel: 0666 504 326

PACK ONE

HOME BUSINESS PACK (P)
This 8 disk pack contains Wordprocessor, Database, Spreadsheet, Amiga Spell, Memo pad, Inventory, etc. etc.
A MUST FOR HOME ACCOUNTS!

- £12.00 -

PACK TWO

DEMO PACK (10 Disks), Budbrain 1 (2 disks), Budbrain 2, Scoopex "Mental Hangover", Palace "Pulling the Trigger", Quartex "Substance", Phenomena "Interspace", Decay "Simpsons Demo"
GREAT STARTER PACK

- £12.00 -

DEJA VU LICENCEWARE

This is Licenceware and costs £3.50 per disk

- LPD 02 ARC ANGEL'S MATHS - Educational (P)
- LPD 03 GALLEONS - Sailing ship combat game (1MB) (P)
- LPD 05 JUNGLE BUNGLER - Childrens adventure. Icon driven-Totally superb! (1MB) (P)
- LPD 08 WORK & PLAY - 3 Great educational games for kids - Very Good! (1 MB) (P)
- LPD 10 WORD FACTORY - Great spelling game for kids! (P)
- LPD 11 GO GETTER - Super quality Board game (1 MB) (P)
- LPD 14 PLAY IT SAFE - Excellent program for teaching safety to young children (1 MB) (P)
- LPD 15 ARC ANGEL'S SHAPES - Remember Fuzzy Felt? (1 MB) (P)
- LPD 17 DOGFIGHT II - Aerial combat for up to 8 players (1 MB) (P)
- LPD 19 X-IT-50 - Very good puzzle game (P)
- LPD 20 WORDY - Good word processor - simple to use
- LPD 21 QUINGO - Quiz game which plays bingo! (1 MB)
- LPD 22 LC10 FONTS - includes font creator (P)
- LPD 23 E.S.F. - recommended game! (P)
- LPD 24 SHINING WAY OF KUNG FU - super quality Beat-em-up game on 2 Disks (1 MB) (P)
- LPD 26 C.Y.A.D. - Brilliant puzzle game! (1 MB) (P)
- LPD 27 FLOWER POWER - Good kids game (1 MB) (P)
- LPD 28 BIG TOP FUN - Top quality educational game (1 MB) (P)
- LPD 32 HARD DRIVE MENU
- LPD 33 ADVENTURE TOOLKIT - create your own adventures (1 MB) (P)
- LPD 34 INVOICE PRINTER - Excellent utility! (P)
- LPD 35 T-TECDRAW - Produce & print technical drawings (1 MB) (P)
- LPD 37 ROCKET MATHS - Good educational game (1 MB) (P)
- LPD 39 MAGIC FOREST II - Addictive platform game (1 MB) (P)
- LPD 44 FORMULA ONE - Highly recommended game (1 MB) (P)
- LPD 45 MUSIC BOX - Music tutor for age 7+ (1 MB) (P)
- LPD 46 MAGPIE CLIPART - Over 300 original images (P)
- LPD 47 DIRTY CASH - the best Fruit machine (1 MB) (P)
- LPD 50 MAGPIE CLIPART 2 - more original pictures! (1 MB) (P)
- LPD 51 MAGICAL YOUNG ARTIST - Super colouring book for youngsters, over 30 pictures! (P)
- LPD 52 LC24 FONTS DISK (P)
- LPD 53 MAGPIE CLIPART 3 (P)
- LPD 54 MAGPIE CLIPART 4 (P)
- LPD 57 KIDS CLIPART 1 - Lots of line-drawn images (P)
- LPD 59 PREHISTORIC FUN PACK - Dinosaur games and puzzles - recommended (1 MB) (P)
- LPD 60 TECHNO-SNAIL - Platform game (1 MB) (P)
- LPD 62 REVOLUTION - Fun game for 4 players (1 MB) (P)
- LPD 63 MAGIC FOREST III - Another good platform game (1 MB) (P)
- LPD 65 POWER PLANNER - Personal organiser (P)
- LPD 66 HOTEL MANAGER - Board game a la monopoly (1 MB) (P)
- LPD 68 VIRUS BUSTER v2.1 - Very user friendly (1 MB) (P)
- LPD 70 PAINT BOX - Another for the kiddies (P)
- LPD 71 BATTLE CARS - Racing game - commercial quality - highly recommended (1 MB) (P)
- LPD 72 MONSTER ISLAND- R.P.G. for children (P)
- LPD 75 VIDEO LAB - Video titling package (P)
- LPD 76 TEC MAZE - For puzzle solvers (1 MB) (P)
- LPD 77 POWERBASE v2.1 - Very professional (1 MB) (P)
- LPD 79 MUSIC ENGINE - Plays music created in MED, Soundtracker, etc. (1 MB) (P)
- LPD 81 POOLS PRO - Predict pools wins (P)
- LPD 82 COLOURING BOOK 2 - Long awaited sequel (1 MB) (P)
- LPD 84 GUESS WHO? - Hangman using digitised pictures of famous people (1 MB) (P)
- LPD 85 MAGIC WASSOCKS - Amusing platform game (1 MB) (P)
- LPD 86 NCOMMAND v2.03 - Adds workbench 2 like displays to AMOS programs - very impressive (1 MB) (P)

UTILITIES

- PDU 10 Worprocessing & Databasing (P)
- PDU 16 Air Tunnel simulation (P)
- PDU 31 Fish # 143 RIM Database (P)
- PDU 32 Fish # 144 Analytic S/sheet (P)
- PDU 43 Fish # 203 Assembler & C (P)
- PDU 51 Fish # 219 Astronomy program

- ✓ **VIRUS FREE**
- ✓ **24 HOURS DESPATCH**
- ✓ **FIRST CLASS DELIVERY**

CATALOGUE DISK

Our latest update contains details of our 2500 disk collection. It also has some FREE games on it. This is one of the most professional disks you will see. Please send 3 First Class stamps to receive your copy. Alternatively, you can have one FREE with your first order.



PACK THREE

MUSIC PACK (10 DISKS), Vision Music Masters, Crusaders "Bacteria Music", Crack Music Disk, Jetset Overload Music, RAF Megamix No 1, Flash digital Concert No 6, Flashing Bytes "Sweet Songs 1", Alcatraz "Panic voices", Crusaders Micro Concert, Archaos Music Disk.

- £12.00 -

PACK FIVE

MUSIC MAKERS (P)
MED 3.20, Pro Tracker, Star Trekker v1.2, 3-Songs Disks 4-Instrument Disks
A MUST FOR HOME MUSICIANS,

- £12.00 -

- PDU 72 SID v1.06 (File transfer util) (P)
- PDU 80 Fonts & Surfaces (P)
- PDU 81 Disksave v1.3 (P)
- PDU 99 Ham Radio Utilities (5 disks) (P)
- PDU 101 Menu Maker
- PDU 102 Label Designer (P)
- PDU 103 Icon Maker (P)
- PDU 104 Icon Mania (P)
- PDU 105 Crossword creator (P)
- PDU 151 Fixdisk (P)
- PDU 164 Games music creator (P)
- PDU 169 Quick-Base (Database) (P)
- PDU 186 Falcon Boothblock creator (P)
- PDU 207 Perfect Sound v1.93 (P)
- PDU 262 MED modules (P)
- PDU 358 Tetracopy (P)
- PDU 359 Genealogy (create Family Trees) (P)
- PDU 366 IBM Emulator (P)
- PDU 367 Atari ST Emulator (English version) (P)
- PDU 368 Spectrum Emulator v1.2 (P)
- PDU 369 Fish # 379 C64 Emulator
- PDU 370 Flexibase (Database) (P)
- PDU 371 Nuke v1.3b (Saddam killer) (P)
- PDU 374 Quick-Draw v1.2 (P)
- PDU 377 M-CAD (Design program) (P)
- PDU 378 Transformer v3.3 (IBM Em)
- PDU 381 C-Light (Ray Trace Utility) (P)
- PDU 380 TEXT PLUS v3.0en (Edit Crunched Files) (P)
- PDU 375 MED v3.20 (With MIDI) (P)
- PDU 382 MESSYSID II (P)
- PDU 383 SPECTRAPAINT v3.2
- PDU 384 DISKMASTER v3.2
- PDU 385 ELECTROCAD v1.4 (P)
- PDU 386 AMIGAFOX v1.1 (English Version DTP) (P)
- PDU 387 WINDOWSIBENCH v1.0 (2 Disks)
- PDU 388 600 BUSINESS LETTERS (P)
- PDU 389 B-BASE II (Excellent, Fast Database)
- PDU 390 TEXT ENGINE v3.0 (Incl. Text wrap and spell check) (P)
- PDU 391 FORMS REALLY UNLIMITED (P)
- PDU 398 AMIBASE PROFESSIONAL II (Database) (P)
- PDU 399 D-COPY (v2.0, v1.0 with Docs) (P)
- PDU 400 NEW SUPERKILLERS (V.C v5.37, Boot-X v4.30) (P)
- PDU 402 GOLF RECORDER v1.0
- PDU 403 NORTH'C (2 Disks) (P)
- PDU 404 HAMLAB v0.91 (IFF Converter) (P)
- PDU 405 AMP1.2 (Amigaspell, X-spell, U-Edit, UES) (P)
- PDU 407 OPTI UTILITIES # 1 (P)
- PDU 408 OPTI UTILITIES # 2 (P)
- PDU 409 GELIGNITE FONTS (Professional Fonts) (P)
- PDU 410 SUPERSOUND II (P)
- PDU 411 IMPLORDER v4.0 (P)
- PDU 412 HARD DRIVE UTILITIES (P)
- PDU 413 PROFESSIONAL D-COPY v3.0

RED SECTOR INC.

- PDU 401 RSI Demo Maker
- PDU 364 RSI Utilities Disk # 1
- PDU 392 RSI Utilities Disk # 2
- PDU 393 RSI Vector Object Editor
- PDU 372 RSI Vectorballs Editor
- PDU 394 RSI Font Editor
- PDU 365 TSB Vector Designer
- PDU 395 RSI Modules # 1, 2 & 3
- PDU 395/6/7 RSI Modules # 1, 2 & 3

PACK SEVEN

GAMES PACK
This NEW 12 Disk pack contains: Operation Lemming, Star Trek, Drip Llamatron, Moria Sealance, Cluedo, Monopoly, Seven Tiles, Pac Man, Battleships. PLUS LOADS MORE (A500+ Option available)

- £15.00 -

SUPER SOUND II

This new sampling software by K.B.E. knocks spots off the competition. This is a full featured P.D. version and is exclusive to P.D. Direct.
A SUPERB PROGRAM FOR ONLY

- £1.75 -

ANIMATIONS

- PDA 10 Exploding Head Animation
- PDA 12 Star Trek # 2 (Agatron) (P)
- PDA 13 Star Trek # 17 (Agatron)
- PDA 14 Puggs in Space
- PDA 15 Moonwalker
- PDA 18 Miller Lite Advert (P)
- PDA 42 Dragons Lair Demo
- PDA 54 NASA Graphics
- PDA 68 Walker Demo # 1 (1 Meg) (P)
- PDA 69 Walker Demo # 1 (2 Meg, 2 Disk) (P)
- PDA 70 Walker Demo # 2 (1 Meg) (P)
- PDA 80 Walker Demo # 2 (2 Meg, 2 Disk) (P)
- PDA 82 Enterprise Leaving Dock (Agatron) (P)
- PDA 81 Ray Trace Art
- PDA 90 Jet Fighter Animation
- PDA 108 Addams Family
- PDA 110 Bruce Lee "Enter the Dragon"
- PDA 111 Bruce Lee Slideshow #2
- PDA 123 Stealthy Animations (Eric Schwartz)
- PDA 124 Stealthy Maneuvres (Eric Schwartz) (P)
- PDI 305 Anti-Lemmin' Demo (Eric Schwartz) (2 Meg, 2 Disk)
- PDA 134 The Dating Game (Eric Schwartz) (3 Meg, 2 Disk)
- PDA 135 Buzzed (Eric Schwartz) (3 Meg, 3 Disk)
- PDA 136 At the Movies 2 (Eric Schwartz) (1 or 3 Meg, 2 Disk) (P)

MUSIC

- PDM 006 Winklers Song (2 disk) (P)
- PDM 009 Ride on Time & Batdance (P)
- PDM 012 Bad - Michael Jackson (P)
- PDM 020 Bat Dance (P)
- PDM 027 D-MOB Megamusic III (P)
- PDM 030 Digital Concert II
- PDM 031 Digital Concert III
- PDM 035 "I think were alone now" Tiffany (P)
- PDM 036 "Land of confusion" Genesis (P)
- PDM 038 Miami Vice theme (4 disks)
- PDM 040 MFI Vangelis Demo (P)
- PDM 065 Digital Concert IV
- PDM 072 Popeye meets the Beach Boys (P)
- PDM 080 Digital Concert VI
- PDM 082 Freddy Kruger
- PDM 083 Kefrens Jukebox
- PDM 085 Miami Vice "Crocketts Theme" (P)
- PDM 088 Slab music (P)
- PDM 091 100 Most remembered C64 tunes (P)
- PDM 095 Hi-Fi Demo (P)
- PDM 104 BassX # 5 Power Remix
- PDM 105 BassX # 6 Sid youngblood (P)
- PDM 106 Betty Boo (P)
- PDM 109 Depeche Mode
- PDM 117 Flash Gordon (2 disks) (P)
- PDM 118 Hatrick "Loadsamoney" (P)
- PDM 120 Laurel & Hardy (2 disks) (P)
- PDM 128 NASP V2.0
- PDM 131 Pet Shops Boys Remix # 1 (P)
- PDM 132 Pet Shop Boys Remix # 2 (P)

CLIP ART PACK

This is a collection of 13 disks. All are in IFF format and are ideal for Desktop publishing. There are loads of images to choose from ranging from fancy borders to special occasions and people to places. They are super quality.
ALL 13 DISKS FOR

- £15.00 -

GAMES

- PDG 1 Star Trek - The Final Frontier (2 Disk) (P)
- PDG 2 Star Trek (3 Disks-Req 2 Drives) (P)
- PDG 5 Card & Board Games
- PDG 16 Monopoly, Cluedo & more
- PDG 21 Boing - The Game (2 Disks) (P)
- PDG 29 Yacht C (Yahtzee) & Others
- PDG 31 Moria
- PDG 32 Legend of Farghail
- PDG 35 Pair It (Educational) (P)
- PDG 46 Fruit Machine, Pool & Others
- PDG 50 Sea Lance (Submarine simulation) (P)
- PDG 53 Megaball (Breakout Style Game)
- PDG 54 Card Games (Harp Platt Queens) (P)
- PDG 60 Air Ace II (P)
- PDG 61 Electric Train Set (P)
- PDG 62 Spectrum Games Vol 1 (P)
- PDG 63 Spectrum Games Vol 2 (P)
- PDG 66 Puzzle Solve
- PDG 70 Drip! (P)
- PDG 71 Llamatron (By Jeff Minter)
- PDG 72 Operation Lemming (£3.00 Charityware)
- PDG 73 Twintus
- PDG 74 Wet Beavers Game (P)
- PDG 75 Tanx The Game (P)
- PDG 76 Cubulus (By T. Richter) (P)
- PDG 77 Star Trek - The Next Generation (P)
- PDG 79 Card Sharp (P)
- PDG 80 China Challenge II
- PDG 81 Pom Pom Gunner
- PDG 82 Wacko Jr. in Wonderland (P)
- PDG 83 Jeopardy (Risk) (P)
- PDG 84 Super Skoda Challenge (P)
- PDG 85 Hollywood Trivia (P)

DEMOS

- PDD 001 Anarchy Demo
- PDD 004 Deathstar Megademo (2 Disk)
- PDD 007 Elvira Demo
- PDD 016 Robocop Demo (P)
- PDD 031 Anarchy "Ooh it's obscene 3"
- PDD 051 Hatrick # 1 "Arsewipe"
- PDD 052 Hatrick # 2 "Smashing day out" (P)
- PDD 055 Kefrens Megademo # 8 (2 disks)
- PDD 062 Northstar Megademo # 2
- PDD 070 Rebels Megademo
- PDD 072 Red Sector Demo # 4
- PDD 075 Scoopex Demo
- PDD 076 Scoopex Megademo (P)
- PDD 096 Magnetic Fields Demo # 36
- PDD 097 Predators Megademo (2 Disks)
- PDD 098 Safe Sex Demo (P)
- PDD 107 Budbrain # 1 (2 disks) (P)
- PDD 115 Magnetic Fields Demo 3 40
- PDD 130 Chubby Brown Demo (P)
- PDD 131 Cronics Demo
- PDD 134 Magnetic Fields Demo # 45
- PDD 152 Flash "No Brain No Pain" (2 disk) (P)
- PDD 153 Billy Gonolly Demo (2 disks) (P)
- PDD 160 Hatrick "Rave on"
- PDD 177 Budbrain II
- PDD 179 Cronics "Total Destruction"
- PDD 238 Iraq vs Kuwait Demo
- PDD 287 Phenomena Engima (P)
- PDD 288 Phenomena Terminator
- PDD 292 Batman Demo (P)
- PDD 306 Digital Innovation By Anarchy
- PDD 307 Virtual Worlds
- PDD 308 Universal Intensity
- PDD 309 Alpha Omega (P)
- PDD 310 Decaying Paradise By Andromeda (P)
- PDD 311 Oddessy By Alcatraz (5 Disks-Superb!)

EDUCATIONAL

- PDE 1 Learn & Play vol # 1 (Under 10's) (P)
- PDE 2 Learn & Play vol # 2 (Under 10's) (P)
- PDE 3 Storyland 2 (Save Toyland from the witch) (P)
- PDE 4 Total Concepts - Astronomy (Interactive Book!) (P)
- PDE 5 Total Concepts - Dinosaurs (Interactive Book!) (P)
- PDE 6 Kidspaint (Very Good) (P)
- PDE 7 Mr Men Stories (Excellent Teaching Aid) (P)
- PDE 8 Simon & Space Maths (Talking Maths!) (P)

FISH COLLECTION

We now stock disks No. 1-629

T-BAG COLLECTION

Disks 1-60 now available

DISK SUPERDEALS

GENUINE PRECISION 3.5" MF2DD BRANDED DISKS
100% Certified & Tested

- 10£6.25 + 0.50 P&P
- 30£16.95 + 1.00 P&P
- 50£26.95 + 1.95 P&P
- 100£49.95 + 1.95 P&P

PRICES INCLUDE LABELS & VAT
NEXT DAY CARRIER ADD £6.50
Carriage applies to UK orders only.
Europe & ROW Price on Application

HOW TO ORDER

DISK PRICES	
1-9	£1.75 each
10-19	£1.50 each
20+	£1.25 each

Postage & packing FREE on all orders of 3 disks P&P £1.00. Europe add 25p per disk. Rest of World add 50p per disk. All of our P.D. software is supplied on quality media.
DEJA VU- £3.50 EACH (P) = Compatible with A500 PLUS

We accept all major Credit Cards.
Please make cheques & P.O.s payable to:

P.D. DIRECT

& SEND TO

DEPT. AF

86 GEORGE STREET,
NEWCASTLE, STAFFS ST5 1DN



PHONE OR FAX

0782 715255

There were fairies at the bottom of the garden. That was until the Evil Queen Bahd (Bahd geddit?) got hold of their gossamer wings, their light-as-an-air-molecule bodies and holier-than-thou attitudes and locked them up in Satan's palace. Guess what the plot is? Yes, you, the big, hard Stormlord have to defeat the queen, free the fairies and make the land of Llyn Cerrig a better place to live in (just like you did in *Stormlord*).

So, we have a flimsy plot (you can also add a touch of the *Dark Crystal* – the evil queen is sucking the lifeblood from the fairies in much the same way as Gelfings had their



Does he really want to jump from here? Not if that ugly guy gets there first. Exciting innit?

life forces sucked). But who cares about plot when the action is as fast and furious as this? For a start there are unlimited axes you can either chuck in a constant flow, as long as you are static, or wield viciously in close combat.

Once you've mastered this art all you really have to do is complete the four levels: Satan's Palace, The Pits of Hell, The Enchanted Palace and Heaven, rescue the fairies and generally be the good guy. Easy really. One point that has to be made clear is the similarity between *Deliverance* (notice, by the way, the lack of John Voigt/Burt Reynolds/Canoe gags) and *Renegade's Gods*. The platform style, ladder climbing (better here than *Gods*), the key collection and even the costume are strikingly similar.

Even claims to 'intelligent' monsters have been retained (a misuse of the adjective in both games. The monsters will still attack, even when they are weaker than you, they won't create traps or try to negotiate peace and sort your mutual problems out in a sensible manner – they will follow you about a bit!).

The key to the whole thing

The control system is easy to get to grips with; there isn't too much for you to pick up and carry around for a start. In fact all you need to worry about are the keys that are harboured within the many chests littered along the way. But beware! This is a game about demonic forces and fairies, so obviously there are booby-chests (and other receptacles too) that contain various hideous monsters. Frankly everywhere you look there are monster-type things. The going gets weird very early on, with thumping fists coming through the floors and ceilings, and even quick-floor areas, these are sections of ground that will attempt to suck you into them if you hang around. Generally there is a slightly surreal feel to *Deliverance*.

You can take huge amounts of damage before getting through your three lives, but this is for a very good reason, not a second

Those cabinets are gaudy to look at and made of rain forest wood. But what the hell, you may as well open them anyway.

You never know, there might be a key in one of them. Or maybe not...



Deliverance



See you pal. Even the architecture hates your guts, and this is only on the first level. God knows what'll hit you in the face later on in the game.



Now you've been and gone and done it, you pushed your three lives to the limit. This looks like the end for the mighty Stormlord. And once that happens, this Ken Russell-like screen comes up to illustrate your demise.



Dig that crazy graffiti baby, or rather don't because you really don't have the time at the moment. Get those infinite blades flying me old chum.

goes by without attacks coming in at you. All good stuff with some smooth scrolling, reasonable collision detection (you can still hang by your toenails from ledges but what the hell, this is a magical land innit?).

It's a kind of magik

To enable you to navigate the passageways, doors, bundles of coins, flying fairies, fire, spiders and general magikness (sic) you even have little amber podules to drop along the way. Thank the gods for that 'n' all, because, aside from the huge statues of naked nymphs put there to distract the red-blooded stormlord – and bewilder the equally crimson-corpusceled Stormlady – the bulk of the areas through which you trek end up looking the same.

Frankly, *Deliverance* has a lot to offer the player who is tired of games where an over-emphasis is placed on brains. It signals the return of good-ole, slash 'em and stash 'em fever. OK, so maybe you have to work out a few measly puzzles as well, there's also a hint that standing around manically slashing at the mounting hordes of evil is less productive than moving nearer to the entrapped fairies – but hey! The little critters can look after themselves for a while longer can't they? Let's flash that axe and go "Hurrghghg-ahhhh!!!".

Tim Smith

Deliverance
21st Century ■ £25.99

- Eh *Gods* it looks familiar.
- Easy control system.
- Excellent in-game music and sound effects.
- Graphically very impressive.

Verdict **80%**

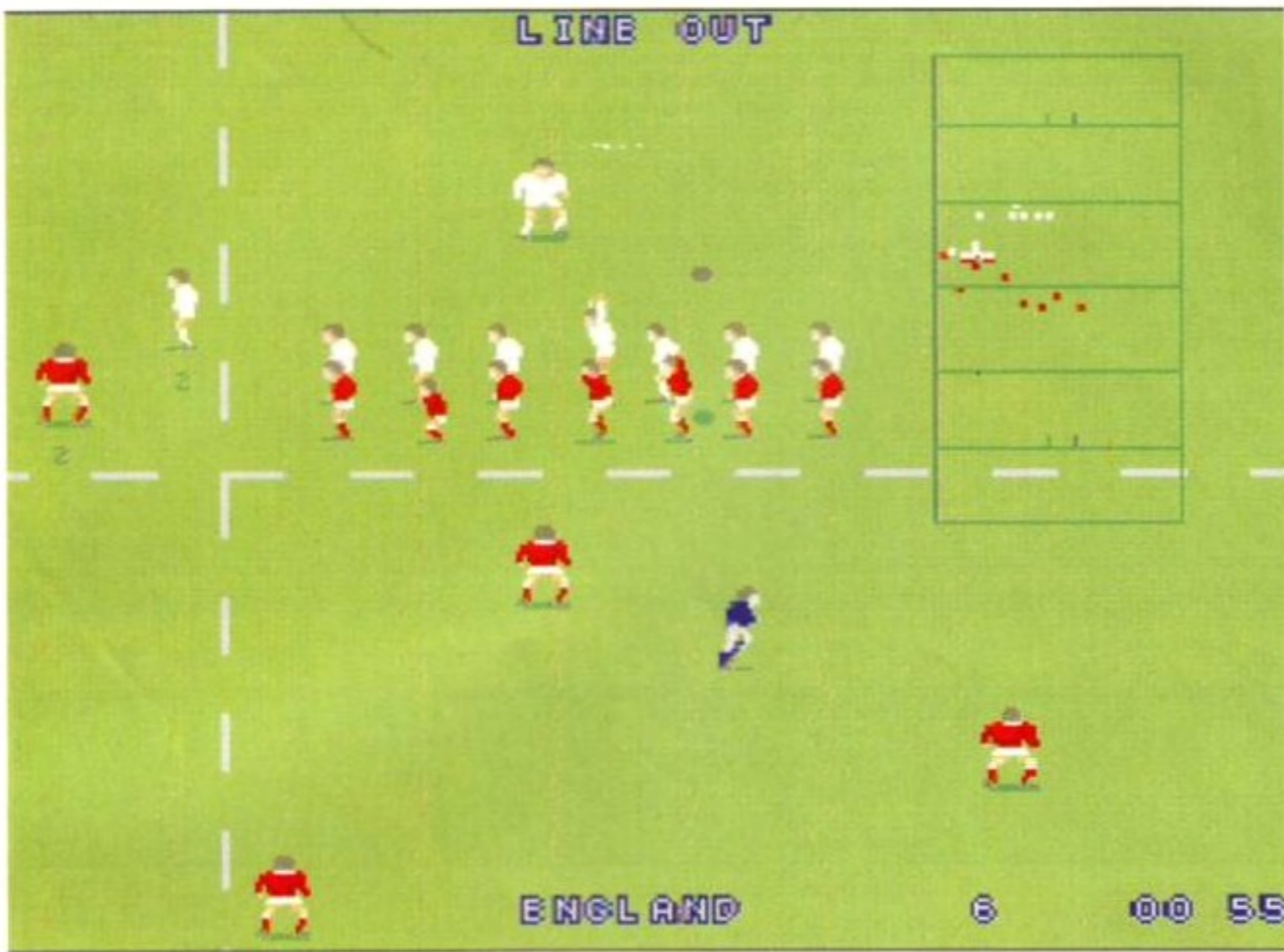

Palming off is a vital part of the line out. (It is also a vital part of journalism, ie "Of course. The captions will be fabulous".)

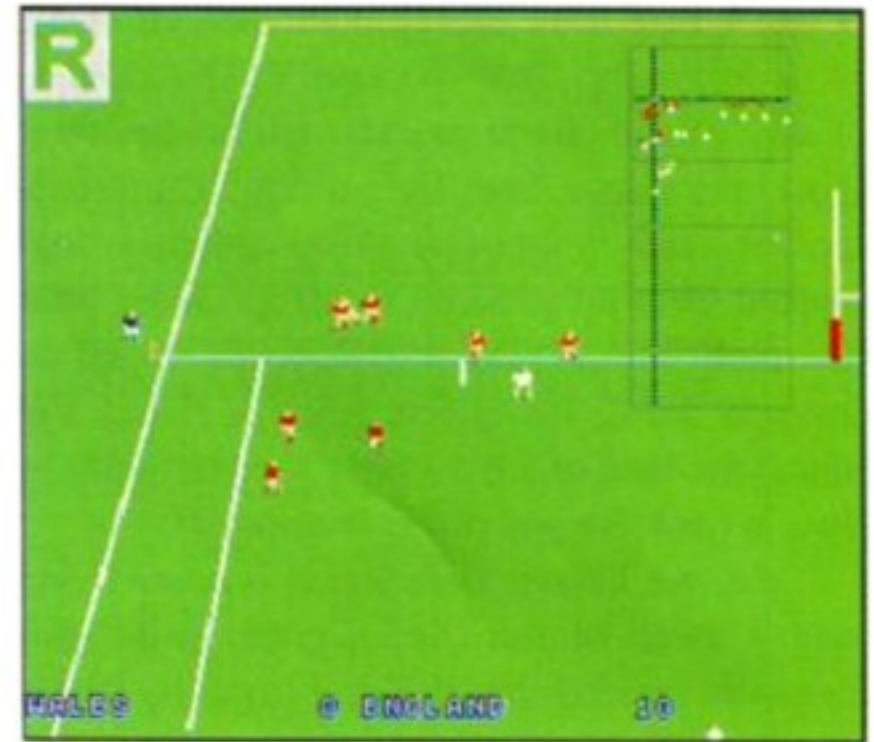

With an expert series of jinks, Nettles leaves the Welsh pack standing. It's another try for England! (Curse the English.)

World Class Rugby - Five Nations

Everyone knows the story behind rugby. It was invented by some fool at public school, it's played by men with odd-shaped balls and has traditionally been confined to the playing fields of high schools, where socially maladjusted teachers encourage freezing first-years to beat the hell out of each other in the name of sportsmanship. It is a documented fact that no English person, above the age of 14, and who isn't a masochist, plays rugby. Those who feel the need to 'scrimmage', 'maul' and 'ruck' in several feet of mud should either take a course of expensive therapy, or else play a computer simulation of rugby. And - hey! - here comes a rugby simulation right now.

Boots, brains and bashing bits

In *Five Nations Edition* you can take part in both the World Cup and the Five Nations Championship. Both competitions are pretty similar, consisting of a number of large men leaping at each other. Before you can take part in either contest, or indeed in a practice friendly match, there's the usual rigmarole of clicking on endless option icons. You can fiddle about with the condition of the pitch, the wind speed, the length of the match, the pitch perspective, the action replays, the more obscure rules, the strip colours... well, you know the sort of thing.

The more interesting options involve the players themselves. In best management tradition, each player has a set of statistics that determine just how beefy and fleet of foot he is. You can alter these in any number of thrilling ways, or switch them off altogether so that, to coin a phrase, all men are created equal. Fiddled to your heart's content? Right, onto the game itself. This is standard *Kick*



Off-ish fare, with lots of fast scrolling and computer-controlled action. By pressing fire you switch control to the player nearest the ball, and a little roving dot in front of the sprite shows the direction any pass or kick will be made in. The inevitable flashing arrows that identify which player you're controlling tend to get lost when the game heats up. A neat-but-ultimately-too-small-to-be-of-real-use radar flashes away in a corner of the screen, showing the swarming dots of your team-mates.

Suddenly, it began to snow. Great grey drifts soon formed, so the teams practised their formation stomping instead.

'Tis a fine game, rugby. Yes it is. Where else could you have the opportunity of meeting new, hefty friends and have them jump on your head?

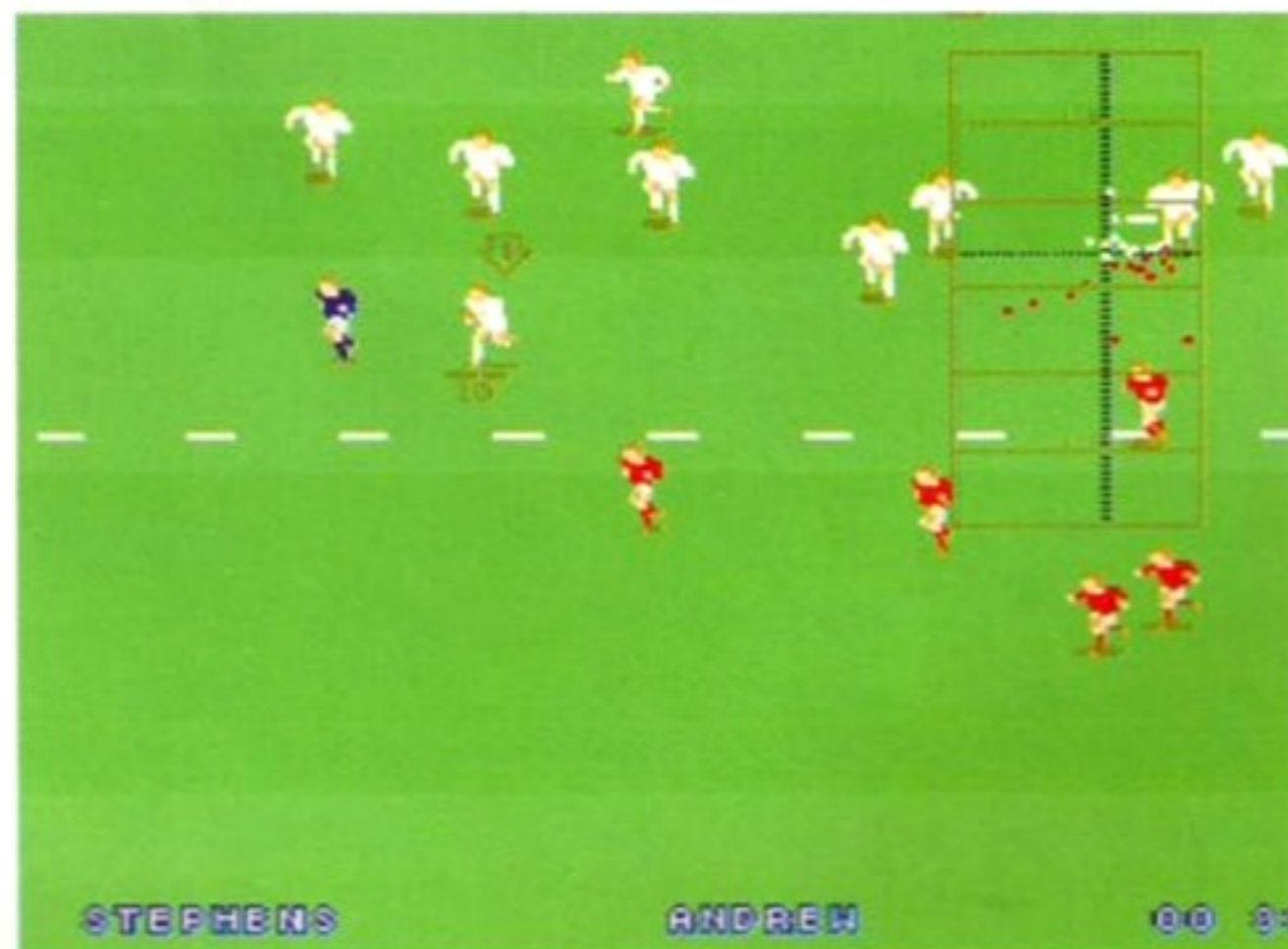

Gameplay is a case of hurling yourself at the chap who is carrying the ball, then legging it away before the others get a chance to realise what has happened. An impressively sneaky feature is that you have to pass the ball to gain any ground - if you try to run straight up the middle, your player gets rapidly tired and slows down to a mere jog.

World Class Rugby forces you to think strategically, which is a bit of a mixed blessing. On the one hand it makes for a more involved game, because you have to keep track of where your players are, so that you can pass to the best possible position. On the other, not being able to nip off to where the fancy takes you slows down the action somewhat. The fact that every single tackle seems to result in a time-consuming scrum doesn't help the pacing of the game either.

But then again...

On the flip side, some of the cleverest bits of the game occur when the ball is not actually in play. In dead ball situations, a set of pre-arranged moves pop up on screen. You select which manoeuvre that you want your chaps to execute, then just sit back and watch them rush purposefully about. When you see an opening, you bash the fire-button and take control of the ball-carrier again. Cunning, dashed cunning.

Summing up in the traditional last-paragraph fashion, I'd say that *World Class Rugby - Five Nations Edition* is a fun little game. If you think you can cope with the jerky pacing and the sometimes confused graphics, there's plenty for you to get stuck into. A quiet, little success, methinks.

Jon Pillar

World Class Rugby Audiogenic ■ £29.99

- Fun dashabout rigger game with some nicely integrated strategy elements.
- Lots of hefty computer opponents, but best with two players - especially as you can both play on the same team.
- Stop-start action tends to spoil the flow of the game. It's not a rigger fan's *Kick Off*.

Verdict 69%

RICOH PCL5 LASER PRINTER

Ricoh UK Ltd is part of the worldwide Ricoh Group of companies, originally established in Japan, in 1936. With a turnover of over \$5 billion and 37,000 plus employees, Ricoh has been producing computers and peripherals since 1971. They are renowned in the industry as pioneers in the field of Office Automation Equipment and have won many awards for outstanding industrial design. Ricoh have employed all their expertise to produce a 'first' in laser printers for the worldwide market, the LP1200 with FLASH ROM.

Fully HP LaserJet III™ compatible, the new LP1200 laser printer employs industry proven laser technology. Unlike LED page printers, which use light emitting diodes, the LP1200's laser lightsource, focussed by high quality lenses, is able to produce the most accurate and intense printed images. It has 2Mb of RAM built-in and requires no additional RAM to print a full A4 page of graphics. Its fast, efficient processor and engine, together with straight paper path design, allows printing at a full 6 pages per minute. Unlike its competitors, this advanced laser engine enables the LP1200 to address a range of print resolutions up to 400dpi. A printer driver is scheduled for release in late April, to enable the Ricoh LP1200 to print at 400dpi from Windows 3.

Again, unlike the competition, the LP1200 includes a powerful document description language as standard. This language, 'LAYOUT', offers unique opportunities to develop custom-made printing systems. In particular, forms and document templates can be designed and stored electronically in the LP1200's unique FLASH ROM, alleviating the need for pre-printed forms!



The Ricoh LP1200 is a genuine laser printer and not an LED printer. Make sure you check out the competition!

See how the Ricoh LP1200 compares to its Laser Printer Competitors

FEATURES	EPSON EPL4100	HP LASERJET III	MANNESMAN TALLY MT904+	RICOH LP1200
Average Street Price (*expected)	£569	£699	£699*	£699
Official RRP	£945	£1,179	£1,099	£1,195
Maximum resolution in dots per inch	300x300	300x300	300x300	400x400
Windows 3 Driver @ 400 dpi (April)	-	-	-	YES
Print Speed	6ppm	4ppm	4ppm	6ppm
Straight Paper Path	YES	-	-	YES
PCL 5 Printer Command Language	-	YES	YES	YES
HP-GL/2 Vector Graphics included	-	YES	YES	YES
Resolution Improvement/Enhancement	YES	YES	YES	YES
Full A4/300 dpi graphics with standard RAM	-	-	-	YES
Warm Up Time	<45 secs	<60 secs	60 secs	45 secs
First Page of Text Output	<20 secs	<40 secs	34 secs	<15 secs
Document Description Language included	-	-	-	YES
Flash ROM	-	-	-	YES
Upgradable Firmware	-	-	-	YES
IC Card Slot	YES	-	-	YES
Scalable Resident Fonts - in HP LJ III Emulation	-	8	8	8
Resident Bit-Mapped Fonts	11	14	14	14
AGFA Intellifont Scalable Font Technology	-	YES	-	YES
HP LaserJet III Emulation Included	-	YES	YES	YES
EPSON FX Emulation Included	YES	-	YES	YES
IBM ProPrinter Emulation Included	-	-	YES	YES
Standard Tray Capacity	100	70	100	100
Protective cover on standard tray	YES	-	YES	YES
Cost per copy*	1.65p	2.00p	1.71p	1.65p
Min-Max Paper Weight in gsm	60-157	60-105	60-120	60-157
Able to print on OHP Film	YES	YES	YES	YES
Able to print on card (157gsm - Manual Feed)	YES	-	-	YES
Auto Sensing on Parallel and Serial ports	YES	-	-	YES
Standby -Noise Level	<40dB	31.7dB	<35dB	<38dB
Printing -Noise Level	<50dB	43.3dB	<46dB	<48dB

*As quoted by manufacturers - 2/4/92 E & OE

All Trademarks are acknowledged

FLASH ROM UPGRADABLE!

400 dpi 2Mb RAM 6 PPM

FULLY HP LASERJET III™ COMPATIBLE

Silica Systems are pleased to introduce the revolutionary, new Ricoh LP1200. It has all of the specifications that you would expect to see in today's most technically advanced laser printer, plus a unique additional feature which places it far ahead of the competition - FLASH ROM. This 'Future Proof' technology protects the investment you make when you buy a Ricoh LP1200, as it enables you to keep up to date with new laser firmware developments. FLASH ROM is an area of memory inside the LP1200 which holds the printer's controller instruction firmware. If new firmware is developed, updated printer command languages etc, can be downloaded into this memory. Other manufacturers would require you to buy a new printer! Fonts, macros, additional emulations and graphics can also be stored in FLASH ROM, or on removable FLASH ROM IC cards. The new Ricoh LP1200 is the only laser printer to offer this FLASH ROM facility.

- **6 PAGES PER MINUTE**
Using a straight paper path design
- **PCL5 - SCALABLE FONTS**
Latest PCL version, includes HP-GL/2
- **SHARP EDGED PRINTING**
RicoH FIAL (Fine Image ALgorithm) enhances resolution
- **400dpi RESOLUTION**
Default resolution - 300dpi. Will address 200, 240 and 400dpi.
- **2Mb RAM AS STANDARD**
Allows printing of a full A4 page of graphics at 300dpi
- **UNIQUE FLASH ROM**
For controller software upgrade and storage
- **IC CARD SLOT**
For programmable FLASH ROM cards
- **EXPANSION BOARD SLOT**
For improved connectivity to additional systems eg. PC-LAN, FAX etc
- **LAYOUT**
Document Description Language
- **SERIAL + PARALLEL PORTS**
For connection to PC compatibles and other computers
- **1 YEAR ON-SITE WARRANTY**
8 hour response

DUAL BIN VERSION

SPECIAL PRICE WITH UNIVERSAL FEEDER (AS SHOWN ABOVE)

£799

+VAT= £938.83
Ref: LAS 5200 + LAA 5238
(NORMAL FEEDER RRP £135+VAT)

LP1200 (WITH SINGLE BIN) SILICA PRICE:

£699

+VAT= £821.33 Ref: LAS 5200

SILICA SYSTEMS OFFER YOU

- **FREE OVERNIGHT DELIVERY:** On all hardware orders shipped in the UK mainland.
- **TECHNICAL SUPPORT HELPLINE:** Team of technical experts at your service.
- **PRICE MATCH:** We normally match competitors on a "Same product - Same price" basis.
- **ESTABLISHED 12 YEARS:** Proven track record in professional computer sales.
- **BUSINESS + EDUCATION + GOVERNMENT:** Volume discounts available 081-308 0888.
- **SHOWROOMS:** Demonstration and training facilities at our London & Sidcup branches.
- **THE FULL STOCK RANGE:** All of your requirements from one supplier.
- **FREE CATALOGUES:** Will be mailed to you with offers and software/peripheral details.
- **PAYMENT:** By cash, cheque and all major credit cards.

Before you decide when to buy your new laser printer, we suggest you think very carefully about WHERE you buy it. Consider what it will be like a few months after you have made your purchase, when you may require additional peripherals or consumables, or help and advice. And, will the company you buy from contact you with details of new developments and products? At Silica Systems, we ensure that you will have nothing to worry about. We have been established for over 12 years and, with our unrivalled experience and expertise, we can now claim to meet our customers' requirements with an understanding which is second to none. But don't just take our word for it. Complete and return the coupon now for our latest Free literature and begin to experience the "Silica Systems Service".

MAIL ORDER HOTLINE
081-309 1111

SILICA SYSTEMS

MAIL ORDER: 1-4 The Mews, Hatherley Rd, Sidcup, Kent, DA14 4DX Tel: 081-309 1111
Order Lines Open: Mon-Sat 9.00am-6.00pm No late Night Opening Fax No: 081-308 0608

LONDON SHOP: 52 Tottenham Court Road, London, W1P 0BA Tel: 081-580 4000
Opening Hours: Mon-Sat 9.30am-6.00pm No late Night Opening Fax No: 071-323 4737

LONDON SHOP: Selfridges (1st Floor), Oxford Street, London, W1A 1AB Tel: 071-629 1234
Opening Hours: Mon-Sat 9.30am-6.00pm Late Night: Thursday until 8pm Extension: 3914

SIDCUP SHOP: 1-4 The Mews, Hatherley Rd, Sidcup, Kent, DA14 4DX Tel: 081-302 8811
Opening Hours: Mon-Sat 9.00am-5.30pm Late Night: Friday until 7pm Fax No: 081-309 0017

To: Silica Systems, AMFOR-0692-75, 1-4 The Mews, Hatherley Rd, Sidcup, Kent, DA14 4DX

PLEASE SEND INFORMATION ON THE RICOH LP1200

Mr/Mrs/Miss/Ms: Initials: Surname:

Address:

Postcode:

Tel (Home): Tel (Work):

Company Name (if applicable):

Which computer(s), if any, do you own?75B

MEMORY EXPANSION

SUPRA 500RX Manufactured out of Albany, U.S.A. SUPRA offer the ultimate in Fast Ram expansion units.

Built to the highest technical specifications they offer full auto configuration and quick easy fitting onto the side expansion port.

8 Mb pop to 1 Mb*	£99.99
8 Mb pop to 2 Mb*	£124.99
8 Mb pop to 2 Mb	£149.99
8 Mb pop to 4 Mb	£209.99
8 Mb pop to 8 Mb	£309.99

*Populated using 256 x 4 Zips, a cost effective way of expanding your system if you are unlikely to require additional expansion greater than 2 Mb. The other configurations use 1 x 4 Zips, a more expensive chip but you are able to expand easily right up to 8 Mb.

PHOENIX A500 Plus 2 Meg RAM Upgrade Modules



PHOENIX RAM Modules will expand your chip RAM up to 2 Mb using the trapdoor expansion port.

Chip RAM is required to unleash the full graphics capabilities of

the Amiga 500 Plus. If you are running out of memory or just thinking of expanding your Amiga 500 Plus system then upgrading has never been cheaper. Designed and built to exacting standards in the U.K. all our boards carry a full 2 year no quibble replacement guarantee.

PHOENIX 1 Mb Fully populated RAM board	£39.99
PHOENIX 1 Mb unpopulated RAM board	£16.99

PHOENIX Kickstart ROM Sharer

Because some older games and business software will not run on the new Kickstart 2.04 ROM.

PHOENIX have designed a sharer for both ROM chip sets. Switchable between 1.3 and 2.04 you can get all the benefits of the latest A500 Plus without the drawback of losing your old software. Fits all Amiga 500/1500/2000.

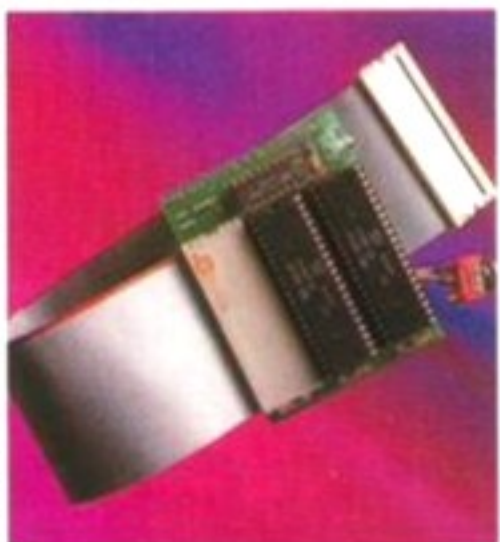

Kickstart ROM Sharer	£24.99
(ROM Chips not included)	
Kickstart 1.3 ROM	£29.99
Kickstart 2.04 ROM	£44.99

If you're upgrading your Kickstart 1.3 Amiga to 2.04, then you may encounter problems if your machine has a revision 3 or 5 motherboard. Not if you use the new Rev 3/5 PHOENIX ROM Sharer. Fits just as easily and is ready to accept the 2.04 chip without the hassle of any tricky motherboard modifications you may have to make.

Kickstart Rev 3/5 ROM Sharer	£27.99
(ROM Chips not included)	
NEW! Keyboard Switchable ROM Sharer	£34.99



PHOENIX

NEW

AMIGA 600



A 600.....£384.99
(including software bundle)

A 600 HD.....£484.99
(including 20 Mb Hard Drive)

Phoenix are pleased to announce the arrival of the eagerly awaited A600. With its modern compact semi portable wedge shape design, the new 600 comes with the following features as standard:

- 1Mb of RAM as standard (expandable)
- Kickstart/Workbench 2.05
- Built in TV modulator
- Standard smart card slot
- Trapdoor expansion port
- 2 x joystick/mouse ports
- Optional internal IDE hard drive
- State of the art surface mount technology

.....ORDER HOTLINE

TEL: 0532 311932

FCC DISTRIBUTION, UNIT 19, ARMLEY PARK COURT, STANNINGLEY ROAD, LEEDS LS12 2AE

TEL: (0532) 311932 U.K. Sales
TEL: (0532) 319061 Trade/European Sales
TEL: (0532) 319061 Technical Helpline

All prices include V.A.T. and free U.K. delivery. Next day delivery by courier £4.50
Please make cheques payable to F.C.C. Distribution Ltd.



AMIGA RELEASE 2

The long awaited Upgrade kit for 1.2/1.3 owners from Commodore has finally arrived and is selling fast.



We have managed to secure one of the largest stocks of this product in the whole of the UK. The package comprises 2.04 ROM chip, all Workbench software (Install disk, Workbench 2.04 disk, Fonts disk and Extras disk.) a huge fully bound highly informative instructional/technical manual covering every aspect of the 2.04 operating system plus an additional "Getting Started" manual, a step by step guide to Workbench 2.04. This is the essential upgrade kit direct from PHOENIX. Please note that due to the excessive weight of this item, we have to charge £2.50 P+P on all orders.

NOW IN STOCK.....£89.99

CHIPS



PHOENIX have bulk buying power which means that prices frequently change. These prices are accurate at the time of going to press but please call for the best deals. Quantity discounts are also available on some chips so please ask.

AMIGA CUSTOM CHIPS

Kickstart 1.3 ROM	£29.99	Fatter Agnus 8372A	£39.99
Kickstart 2.04 ROM	£44.99	CIA 8520A	£14.99
NEW Super Denise	£34.99		

MEMORY CHIPS

4 Mb x 9 (-70) Simm	£119.99	1 Mb x 4 (-80) Zip	*£34.99
1 Mb x 9 (-80) Simm	£29.99	*This price is for 1 Mb of RAM	
256k x 9 (-80) Simm	£12.99	256k x 4 (-80) Zip	*£29.99
256k x 4 DRAM	£3.49	*This price is for 1 Mb of RAM	

These chips cover practically every popular memory expansion or Hard Drive system on the market for the Amiga ie. GVP, SUPRA, MICROBOTICS, COMMODORE etc.

RING OUR TECHNICAL HELPLINE IF YOU NEED ADVICE

HARD DRIVES

PHOENIX are pleased to offer the stunning range of GVP IMPACT SERIES II Hard Drives, the fastest Hard Drive/Controller for the Amiga.

Features Game Switch, external SCSI port, FAAASTROM SCSI Driver, GVP's custom VLSI chip and internal RAM expansion up to 8 meg! All units use high specification fast access QUANTUM Hard Drives.

A500-HD8+ 52 MEG(Unpopulated)	£349.99
A500-HD8+ 105 MEG (Unpopulated)	£469.99
Series II 52 MEG Hard Disk and RAM card	£279.99
Series II 120 MEG Hard Disk and RAM card	£419.99
Series II 240 MEG Hard Disk and RAM card	£649.99

EXTRA MEMORY FOR ALL GVP ONLY
£29.99 PER Mb !

VIDEO

ROMBO-Complete Colour Solution.....£84.99!
Amazing Price Reduction!

ROCTEC have established themselves in the computer peripherals market as makers of high quality products and their genlocks are no exception.

ROCGEN Plus.....SPECIAL OFFER-ONLY £129.99
Quality features and performance. Recommended.

NEW

PHOENIX PRODUCTS

Continuing in our pursuit of excellence, Phoenix are proud to announce the release of a brand new range of Amiga peripherals including:

Stereo Sampler	£34.99
(inc. FREE sample editing software + audio lead)	
Pro-Midi 2 Interface	£24.99
(inc. FREE midi lead)	
Mouse/Joystick Switch	£13.99
Computer/Video Scart Switch	£19.99

For a moment, imagine you're a lord of the manor, in the 12th Century and you are looking for somewhere to live. Do you choose: a) a small brick building on the outskirts of a village, replete with your own privy, or b) a sodding great brick building which virtually is a village, replete with en suite privies in every chamber?

Castles begins just after you've chosen b). To wit: you must design, build and ultimately defend your very own castle.

The designing bit is easy. Having chosen a suitable bit of land, you're presented with a plan view upon which you can lay various components of the castle: towers, wall segments (of varying thicknesses) and of course a gate. The only restriction is that you can't change a wall's direction without sticking in a tower to support it.

New castle

Once your design is OK, you need to hire some labour. There are seven categories of labourer available, such as diggers and masons, and it's down to you to hire the right mix of workers to get the castle cracking. They're all important in their own way.

Next you need to assign each section of your blueprint a number of labourers. Then off they trundle, collecting raw materials, sawing wood, breaking stone and lo and behold, there in the 3D view, your castle begins to grow.

There's another problem here. It's impossible to build a wall segment more than four-feet taller than either of its adjacent segments, because it just won't stand up. Thus if you start building mid-wall the workers will soon stop with the message "Unstable", forcing you to build up the side segments before you can continue. While all this is going on it's wise to hire some military – because sooner or later your prize castle is going to be attacked. There are two sorts of military, archers and infantry, and they need training if they're going to be any good in battle. Food, too, is a good buy. If you're sieged by the enemy, a good scran is a damn handy thing to have about. Bear in mind, though, that it's far cheaper just after the harvest and very expensive in the spring.

You don't get anything for free; your labourers need wages, as do the military, on top of the food and supply costs. Your only source of income is taxing your subjects; if you're short, you can bump up the rate, but then there's the risk of having a mob of peasants coming round to, er, complain. You can always contact your treasurer for advice.



NEEDS 1 MEG

A messenger arrives:
"Grim news, my lord!
They didn't have any
Creme Eggs left so I
got an Aero instead.
Sorry".



Castles

The wall segment over by the right tower has just collapsed and is being rebuilt. You just can't get the labour, can you?

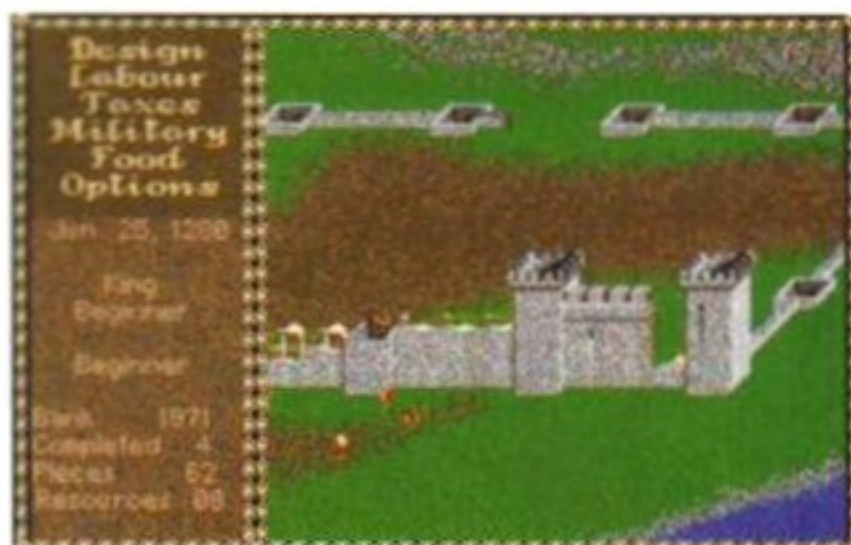

Got the moat, got the military in position, got the Twiglets... trust the enemy to be fashionably late.

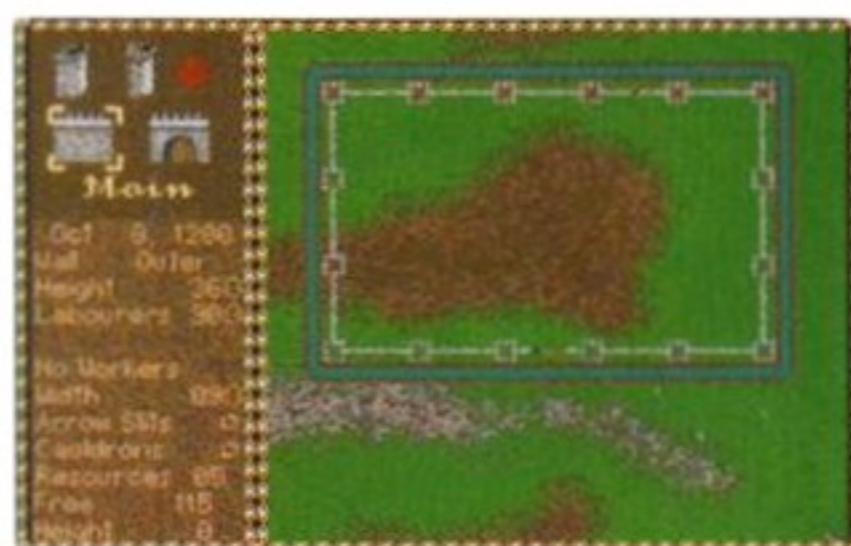

HARD DISK INSTALLABLE

Having sliced their way through the infantry, the building inspectors march on relentlessly to inspect the dodgy damp course.



Advice is available, on how you stand with the plebs, from Sir Richard of Westhampton, a reliable man who tells it like it is.

Roy castle

Just as your castle is coming along nicely you're attacked. By what depends on whether you chose to play the game in the real world, in which case it's usually berserk Celts, or in a fantasy world, when it's generally ogres. Either way you have a limited time to arrange your military around your castle before the onslaught. Each unit attacks the enemy closest to it, though you can direct them otherwise. If the enemy manages to reach the castle and destroy enough of it, it's literally back to the drawing board.

Occasionally you receive a messenger with news of happenings in other parts of the kingdom, and a request. For example, you might be told that Sir Richard of Norshire has completely ballsed up in battle again, and then you're given the choice of "sacking" him, sending him some money or ignoring him. Your decisions here affect your popularity with both the peasants and the church.

Once the castle is finished and you've fought off several thousand rampant nasties, the level is complete and it's off to the next area.

Caernarfon castle

Castles is a good example of how to make what is on paper a thoroughly dull concept come alive in practice. Designing castles is great fun on its own, but watching while they're built is almost mesmerising. The graphics and character animations are actually quite primitive, but when enough men are working away on screen at once, you really get a feeling of business. The messenger screens gradually add an element of medieval soap opera to proceedings as you follow the fortunes of your subjects, and the enemy's attacks are spaced far enough apart not to be too annoying – unlike the music.

Sometimes the game becomes a little plodding when there's not much going on but castle building. You will need to set aside a couple of hours to play it properly, even with the save function. But on the whole *Castles* is innovative, well-designed, fun and built to last, in that order. Unlike en suite privies.

Ed Ricketts

Castles Electronic Arts ■ £25.99

- Good tutorial in the manual eases you smoothly into this rough-and-tumble business we call castle building.
- Unexciting graphics but they do the job.
- Messenger screens provide some light relief and plenty of opportunities for you to abuse the Church.
- Can be somewhat drawn out – not something you'd load up for five minutes' play.



72%



Dramatic and colourful backgrounds are the order of the day, but don't sit around admiring the view for too long, because there's some serious alien plummeting to be had.

Certainly the best shoot-em-up to rear its head for some time. The thing you have to do here, though, is bury this ugly mother's head with plenty of fire-power and homing missiles.



away at those final end-of-level guardians, you aren't rewarded by the 'Pow' factor when they finally explode in the same way that you do with games like SWIV.

Believe it or not, this game has four disks. Why on earth is this the case when the likes of *R-Type* seem to manage quite happily with one. Well Team 17 have aimed *Project X* at giving you VFM, so four of the blighters gives you more levels than you can shake a big stick at. After completing a level, which is no easy feat, it's time to change disks and move on to the subsequent level. The only tiresome part of the loading is the intro, which is about as interesting as a message from your cashpoint as you wait for your readies.

Mutton dressed as llama?

The more you get into the game the more you begin to notice the resemblance to *Nemesis*. The game does seem dated and although the graphics and the backdrop are pleasing, there isn't anything here that distinguishes it from the rest of the shoot-em-up crowd.

The game may enthrall you for a few hours, it certainly proved a popular blast for those in the office who were born of frustration and wanted a quick 10 minutes (which soon turned into 60) of power-ups, wild screens and mothers of all guardians to zap their way through. But, if any other decent shoot-em-up had been lying around there would be no good reason to make you plump for this one.

It would have been nice to see a simultaneous two-player mode, and maybe something unique to *Project X*. As it is, the only new thing Team 17 have brought to the genre is the longevity of the whole experience. This is no bad thing, but these days you have to do something more pioneering to make a name for yourself in this industry.

Paul Wilson

Project X



All right they're bigger than you, but have you never heard that size isn't everything?



OK so you've made this sucker bite the dust, but there's still another three disks to get through.

There has been a distinct lack of high-quality scrolling shoot-em ups, the last one that really sticks in your mind was SWIV, it certainly had the entire **Amiga Format** offices enthralled. Even with its impressive array of add-ons, it still remained completely smooth and perfect. So, following in the likes of *R-Type 2* and *Z-Out*, Team 17 have decided to have a go at their own scrolly shoot-em-up project and they've called it 'X'.

The plot is rudimentary: you take on the part of a pilot who controls a spaceship (various models, depending on your forte: speed or armoury). Your mission is to save the planet RYXX, which has been infested with the usual concoction of aliens and bad guys.

Who's got the power?

Power-ups appear as you obliterate each alien ship, these can be utilised with a depress of the space-bar or a sideways juggle of your joystick. These are traded for various weapons: homing missiles which randomly seek and destroy, a plasma laser – yellow and deadly; sidoshots are superb for zapping aliens who think they are just going to pass you by; speed – this can be a hindrance if you're not a competent pilot; magma at full power is a lethal

weapon and a whole host more which will help you deplete this poor alien race. If all these power-ups aren't enough, and you crash and die, then you start off again at more or less the exact point where you just died. Unless of course you've lost all four lives then it's back to the first part of your scrolly mission.

The graphics are incredibly well drawn and create their own ambience. They do let themselves down at times though; when you've worn out your joystick fingers by hammering

It's no good just letting them do a ceremonial fly past. What you could do with here is some sideways power-ups.



Project X
Team 17 ■ £25.99

- If you get bored of the Old Timers theme tune you can plump for the Rave tune.
- Something old and something new.
- Comes complete with four alien-infested disks, painful intro screen though.
- You certainly get your money's worth in terms of gameplay
- Plenty of lurid and ambient backdrops.

Verdic 75%

**"Miss this
and you
will regret
it forever"**



**"Fast just isn't the word for this
3D. The image update
is blistering!"**
ACE

**"Anyone
who has been
keeping an eye out
for this will not be
disappointed, and should
await its release with
bated breath...Epic is one
of the best products I have
ever played - the depth of
gameplay and graphics
are of a truly stunning
standard."
GAMES X**



**"The overall
feeling you
get is one
of awe"**
ST ACTION



**"The game's
graphics and
presentation are
nothing short of
stunning, and
there's a great
wad of playability
in there too.
Ocean have never
had it so good!"**
ST ACTION

**ATARI ST
CBM AMIGA
IBM PC &
COMPATIBLES**



OCEAN SOFTWARE LIMITED
6 CENTRAL STREET . MANCHESTER . M2 5NS . TEL: 061 832 6633 . FAX: 061 834 0650



SOLUTION

TOTAL AMIGA COMPUTING

From Commodore

The World's Largest Supplier of Computers

AMIGA A2000 SERIES

- Motorola 68000(7.14 Mhz) 16/32Bit
- 1Mb Ram Exp. to 9Mb Max
- 1x 3.5" 880K Internal Floppy Drive
- 5 x Amiga Slots + 4 x IBM Slots(2XT)
- WIMP Controlled Operating System
- 94 Key Qwerty Keyboard
- 2 Button Mouse
- Amiga Chip Set

A2000	CPU	MONITOR
52 MB	£ 999.00	£1248.00
105MB	£1199.00	£1448.00
210MB	£1399.00	£1648.00

AMIGA A3000 SERIES

- Motorola 68030/68882 FPU 25Mhz
- 2Mb Ram Exp. to 18Mb Max o/b
- 1x 3.5" 880K Internal Floppy Drive
- 5 x Amiga Slots
- Amiga Chip Set
- 94 Key Qwerty Keyboard
- 2 Button Mouse
- WIMP Controlled Operating System

A3000	CPU	MONITOR
52MB	£2199.00	£2549.00
105MB	£2395.00	£2745.00
210MB	£2545.00	£2945.00

AMIGA A1500 SERIES

CPU
 Motorola 68000(16/32-bit)
 7.14Mhz Clock speed
 1Mb Ram(Expandable to 9mb max.
 with additional memory board
 2 x 3.5" 880k FD

MONITOR
 1084S/PHILIPS CM8833 II
CURRENT SOFTWARE BUNDLE
 Deluxe Paint III
 The Works Platinum
 Home Accounts
 Puzznic
 Toki
 Elf

KEYBOARD & MOUSE

£899.00 INC.VAT

AMIGA A1500 IS A FAST EXPANDING MACHINE WHICH IS IDEAL FOR YOUR EVERYDAY COMPUTING NEEDS. SUPPLIED WITH UP TO DATE SOFTWARE AND HARDWARE TO KEEP YOU IN TIME WITH THE FAST MOVING COMPUTER INDUSTRY. ALL HARDWARE AND SOFTWARE FOR THE A2000 ARE FULLY COMPATIBLE.

ACCESSORIES

HARD DISK CONTROLLER CARDS
HARD DISKS
RAM EXPANSIONS
MEMORY CHIPS/SIMMS
FLOPPY DISK DRIVES
GRAPHICS BOARDS
GENLOCKS/VIDEO
SCANNERS
LASER PRINTERS
MONITORS
PROCESSOR CARDS
IBM BRIDGEBOARDS
AUDIO ACCESORIES
MODEMS/FAX CARDS
CABLES
SOFTWARE(NON-GAMES)
PLEASE CALL ON LATESTED PRICES

CDTV

CDTV

MULTIMEDIA

£499 inc. VAT

Commodore Business Centre carries a large range of CDTV accessories including: Keyboard, Disk Drive, Trackball & most CDTV software.

AMIGA 500PLUS

1MB RAM
Workbench 2.04
Cartoon Classics Pack
£359 inc. VAT

- MULTIMEDIA
- DESKTOP PUBLISHING
- DESKTOP VIDEO
- DESKTOP PRESENTATION
- VIDEO TITLING
- 2D/3D GRAPHICS
- 24BIT DISPLAYHARDWARE
- MUSIC
- EDUCATION
- SCANNING
- IMAGE PROCESSING
- NETWORKING

At London's Commodore Business Centre you will find helpful sales and technical staff able to offer you informed advice on choosing a computer solution. most systems advertised are on demonstration and can viewed in an everyday work environment. Alternatively, you can use our efficient mail order service with the assurance of quality products and support.

ALL MAJOR CREDIT CARDS ARE ACCEPTED.



This ad was produced on a Amiga A3000 using Professional Page 2.1 By CBC Staff.

Telephone: 071 833 5609
Facsimile: 071 837 1264

All Prices Exclude 17.5% VAT Unless Otherwise Stated

Commodore Business Centre



Commodore Business Centre
 61 Russell Square
 London WC1B 5BB
 Telephone: 071 833 5609
 Facsimile: 071 837 1264

TOTAL! The only magazine dedicated to Nintendo gamers, full of reviews and tips for the NES, Game Boy and Super NES!



Our dead smart logo – look out for it in the shops!

Nintendo's stonky new super console – read all about it!

Ooouch! Hey, just watch it! These arrows are a bit flippin' sharp. Careful, there's skin in that!



Like WOW! Heavy-duty compo or what?

Andy 'Thicky' Dyer.
Writer and twonk

Er... the bar code (ignore this bit)

Steve 'Misery Guts' Jarratt.
Editor and dweeb

16 pages full of Game Boy reviews!

18 pages crammed full of NES reviews!

10 pages stuffed with tips!

OW! I hate these flippin' adverts. It's all your fault Dyer, 'ooh, lets be in the ad' you said! Stupid great berk!



Got a Nintendo? Then get TOTAL! Issue five is on sale right NOW!

Whip out yer leather jerkin. Roll up some stats. Practice saying things like "I come from the city of Thrang" with a straight face. It's sequel number three, and it's bigger than big.

The first foes you come across are these rather charming giant rats. Be prepared for a lot of dying and temple-visiting in these early stages - *Might and Magic* don't come easy.



Might and Magic 3 - Isles of Terra

AMIGA FORMAT

80

JUNE 1992

Sequels. Love them or hate them, you can't deny that they're follow-ups to other games. *Ultima 6*, *EOTB 2*, *Monkey Island 2*: where will it end? Quite possibly, deep in the heart of *Might and Magic 3*.

Taking the view that size is important after all, *MM3* is a massive role-player that takes up, not surprisingly, where *MM2* left off. The Isles of Terra (terror - hey! nice pun) are in deep trouble, thanks to the inglorious plans of someone called Sheltem. He seems to have an irrational hatred of isles and thus desires to blow Terra away. Your job, brave stranger, is to find him and persuade him otherwise.

Reel around the fountain head

The game begins in the intriguing town of Fountain Head, where strangely enough the fountains look like heads. After visiting the inn to roll up some characters you're off on the quest. *MM3* uses the usual first-person *Dungeon Master*-esque perspective view and movement of your six-character party is achieved in the conventional way, square by square. A bank of icons allow more complex actions like resting, casting spells and viewing a map of the surrounding area.

Obviously you're not going to bump into Sheltem strolling down the road; the ultimate goal is achieved by completing many smaller sub-quests over the five islands. Wandering around Fountain Head you eventually hit upon your first quest, to free the town's founder Morphose from the Rat Overlord. This is quite a task, which involves a further sub-quest, and is a good introduction to the game's workings.



It's possible, but certainly not advisable, to leave Fountain Head and go off wandering without completing the quest. In fact you can go pretty much anywhere you like provided you've got the right objects. Towns are always good places to visit because of the facilities

"If you've never been inclined to go for an RPG, *Might and Magic 3* could well change your mind."



they offer: spells can be bought from guilds, as long as you're a member; taverns are good places from which to get clues, shops offer new weapons and armour, and there are even vaults in which you can deposit some of your gold and earn interest.

Although *MM3* isn't an official *Dungeons & Dragons* game it's very much based on D&D rules. Characters have races and align-

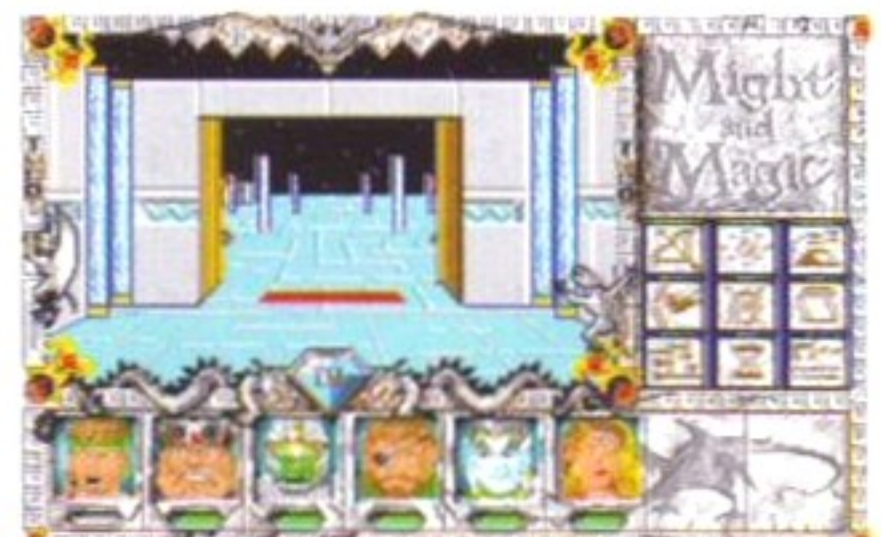

And on Saturdays our adventurers take time out for a little R'n'R.

ments (good, bad or neutral) which affect the weapons and spells they can use, together with all sorts of stats related to their armour, weapons etc. There are plenty of chances to temporarily or permanently alter these stats through the potions and spells. Like fighting, spell use is improved through practice.

One interesting innovation is the use of the screen decoration as warning indicators.



"Yes, I'll have whatever those drunken adventurers are drinking. Oh, and two rumours and a tip for my friend please." "Certainly, sir. Your tip is: you're drunk." "I'm not drunk, I'm just strangely happy."



Leave Fountain Head unprepared and you'll end up dead at the feet of all these orcs. During combat the action icons to the right change to reflect the new commands, like Cast and Quick Fight.



Welcome to the Temple Greede. For a small fee our trained priests can heal the sick, undrunk the drunken and even revive dead peeps. Faith not required, major credit cards accepted.



The ground shakes with the thunder of hooves as horsemen practice swordplay in mock country combats. The Master of Arms yells above the clatter, "Do go seek trainin'!"

Case in point: if one of your characters has the skill 'Detect Secret Passages' (which can be learnt), and you're facing a wall with said secret passage, the gargoyle at the bottom right of the screen waves his arm, so you know it's possible to bash in the wall. Other creatures around the main display animate in certain important situations. It's a small but pleasing touch.

Magic, roundabout

If you've never been inclined to go for an RPG, or if you've been disheartened by past experience, *MM3* could well change your mind. It's a huge, detailed and immensely enjoyable sprawl of a game. Graphically, it varies from the really quite good, semi-animated graphics of static screens (like the shop), to the amateurish look of the countryside scenery. The monsters won't scare you, having only two or three frames of animation

each. Sound-wise there are a few standard samples and some annoying music.

The lack of stunning visuals doesn't matter. The effects are, or should be, secondary to the gameplay, and for once the gameplay is enough to keep you bashing away for ages. It's only when you look at the game map that you realise what a huge undertaking completing *MM3* is. Fountain Head alone should keep you at it for four or five hours, and that occupies a tiny part of the game world. *MM3* comes on five disks and while playing from floppy is bearable you're better off with a hard drive.

Might and Magic 3 offers genuine value for money. Perhaps now and again it leans too heavily on combat, and at other times on its lists of statistics, but on the whole it's a rattlingly good ride.

Ed Ricketts



These magical big round mirror things in the shape of big round mirrors are actually tele-ports. The world is your oyster, but only if you know the name of a destination (try ARENA for starters).

MIGHT AND MAGIC
New World ■ £40.99

- Massive game that's chock full of sub-quests.
- Graphics sometimes disappointing. Great intro though.
- Hard disk or dual floppy drive required.
- Should appeal to both seasoned RPGers and newcomers and keep both going for ages.



FOOTBALL MASTERS



Football Masters is the very latest Multi-Manager Football Simulator for 16 bit computers. After 4 years of development we are proud to announce the release of the most comprehensive football management game ever. It's waiting to test your skills right now! Features Include:-

- Multi-Manager game for 1 to 4 Players. Three levels of difficulty.
- Match highlights minute by minute, make substitutions or team changes at any time. Live injuries, yellow/red cards and named goalscorers. 1MB version has extra Graphics, animations and realistic digitised sounds. (An option can turn this feature off).
- Full UK and European Cup itinerary. Includes FA, League, Zenith Data, Leyland Daf, European, Cup Winners and UEFA Cups. All cup match rules have been made as accurate as possible. Two Leg Ties, Extra Time, Away Goal Rule, Seeded Draws, Byes, etc.
- All 4 league divisions with play-offs and league expulsion.
- Real initial, surname, league career records, height and age entered for all players as at the start of the 91/92 Season. Five skill ratings per player, separate five for goalkeepers. Plus 15 other special attributes like Captain, Super Subs & Mobility.
- A lively and real-time transfer market, with an approach facility, negotiate wages and contracts. Plus loans, free transfers and trainees. Unique and simple training system to improve player skills.
- High quality printer facilities to list all the vital information. Masses of historical statistics on past games, players and manager. Quick game data load and save.
- All screens updated quickly and displayed in a pleasant format, which is easy to use and comfortable to read. Fully mouse operated. Printed instruction booklet with plenty of diagrams. A separate Editor is available to change saved/initial details.



48 Hour Dispatch Available

A500Plus Compatible

There are many, many other little things that make this game the most addictive and accurate interpretation of a Football Managers season. It would be impossible to list all the features in this advert but we assure you that this is the best. We have thousands of satisfied customers from our previous edition of this game, many are still playing it 18 months after purchase. See the order form below for details on how to order this incredible game. Available for all Atari ST's and Amiga's. PC version coming soon.

WRESTLING MASTERS

An amazing graphical strategic simulator that's fun for all the family. 0, 1 or 2 players on keyboard, mouse or joystick. Pick your moves from the selection available and watch your animated warrior battle it out. Watch the energy bar indicators and plan your moves.

You can edit your very own new wrestler or amend a wrestler already created (16 are provided on the game to begin with). You can change any name, colour of tights, linings, flesh tone and hair together with all the fighting skill values, weight etc. Instructions are also provided which show you how to change the way any wrestler looks or you can create whole new ones. Amiga 1MB RAM. Only £19.95

24 HOUR CREDIT CARD HOTLINE

(0702) 600557 Answer Phone Outside Office Hours
FAX (0702) 613747

MAIL ORDERS

All the programs detailed in this advert are only available through direct mail from ESP Software.

Name Address

..... Postcode Tel

I have an computer, please send me the following items:-

Quantity	Description	Unit Cost	Total
	Football Masters 512K	19.95	
	Football Masters 1MB	24.95	
	Football Masters Editor (Not 512K Amiga)	12.00	
	Wrestling Masters (AMIGA 1MB ONLY)	19.95	
	Amiga 512K RAM Expansion	29.00	
	Amiga 512K RAM Expansion + Clock	34.00	
	POSTAGE (Non UK add £1.00, not BFPO)	1.00	
	GRAND TOTAL		

If you have a cheque guarantee card or credit card please write its number on the reverse of your cheque, doing so will ensure dispatch within 48 hours of receipt.

I enclose a Cheque/Postal Order made payable to ESP SOFTWARE.

Cut out and post this form to:(photocopies or written orders are acceptable)

ESP Software (AF), 32a Southchurch Road, Southend-on-Sea, Essex SS1 2ND, UK.

ESP Software, 32a Southchurch Road, Southend-on-Sea, Essex SS1 2ND

FED UP WAITING?

JUST ADD £2.00 TO YOUR TOTAL
ORDER FOR A GUARANTEED
NEXT DAY DELIVERY TO YOUR DOOR

(*ORDERS MUST BE PLACED BEFORE 3.30pm excluding Weekends)



COMPUTER MATES (UK) LTD.

Fastest
Mail Order Company
on Earth

CHEQUE/POSTAL ORDERS TO:
COMPUTER MATES (UK) LTD.
PINWOOD STUDIOS, IVER HEATH
BUCKS, SLO ONH
TEL: 0753 553535 (3 Lines) FAX: 0753 553530

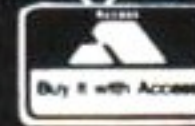

ALL PRICES INCLUDE V.A.T & DELIVERY

BOX/10 1-5	MITSUBISHI BRANDED DISKS			
	5.25 M-2D	5.25 1.6 Meg M-2HD	1 MEG MF-2DD	2 MEG MF-2HD
	5.00	7.00	7.00	12.00

**LOOK GREAT DEALS
ON MITSUBISHI BRANDED DISKS**

50 MF-2DD + 50 CAPACITY BOX	£35
100 MF-2DD + 100 CAPACITY BOX	£68
50 MF-2HD + 50 CAPACITY BOX	£60
100 MF-2HD + 100 CAPACITY BOX	£95

NEW JUST APPOINTED DEALER

**GOLD MASTER BRANDED
2 FOR 1 LIFE TIME WARRANTY**

	1 MEG MF2DD	1 MEG MF2DD RAINBOW	2 MEG MF2HD	2 MEG MF2HD RAINBOW
1 BOX	6.50	7.50	13.00	14.00
2-5 BOXES	6.00	7.00	12.50	13.50
6-10 BOXES	5.50	6.75	12.00	13.00

Rainbow Colours — White, Red, Green, Orange, Yellow

**3.5" MITSUBISHI BULK MEDIA
LIFE TIME WARRANTY**

3.5"	DSDD	DSHD
50 Disks	£21.00	£32.50
100 Disks	£40.00	£63.50
200 Disks	£79.00	£125.50
500 Disks	£185.00	£295.50
1000 Disks	£360.00	£580.50

INCLUDING LABELS

**5.25" BULK DISKS
Packed in 25's with Envelopes,
Labels, Lifetime Warranty**

	48tpi	96tpi	HD
25 Disks	£8.50	£8.75	£12.00
50 Disks	£16.00	£16.25	£23.00
100 Disks	£28.00	£27.25	£36.00
1000+ PLEASE CALL			

**COLOURED DISKS
LIFE TIME WARRANTY**

5.25"	48/96tpi DSDD	1.6 Meg DSHD	3.5"	1 Meg DSDD	2 Meg DSHD
25 Disks	£9.00	£16.00		£14.00	£20.00
50 Disks	£17.50	£30.00		£25.00	£35.00
100 Disks	£31.00	£51.00		£45.00	£68.00

Includes labels, for available colours please call.
Normally Red, Green, Yellow, White & Orange

**NEW NEW NEW NEW
COMPUTER MATES
BRANDED DISKS
2 FOR 1 LIFE TIME WARRANTY**

3.5" DISKS	COLOURED	
	DSDD	DSHD
50 Disks	£23.00	£35.00
100 Disks	£43.00	£69.00
200 Disks	£83.00	£137.00
500 Disks	£190.00	£325.00

MICE/TRACKERBALLS

PC/XT/AT MOUSE	£20.00
PS2 MOUSE	£21.00
AMIGA/COMMODORE	£19.00
ATARI MOUSE	£19.00
ATARI/AMIGA TRACKBALL	£22.00
PC/XT/AT TRACKBALL	£22.00
MOUSE MAT	£2.50
MOUSE POCKET	£2.50
MOUSE STAGE	£10.00
MOUSE MAT HARD	£3.50
PAPER TRIMMER	£5.00

Victory

STORAGE BOXES

3.5"	5.25"
120 Cap	£9.50
100 Cap	£7.90
80 Cap	£7.50
50 Cap	£6.50
40 Cap	£6.00
140 Cap	£8.75
120 Cap	£8.25
100 Cap	£7.50
50 Cap	£6.50
20 Cap 3.5"	£4.00

ALL ABOVE BOXES LOCKABLE + 2 KEYS.
£2 OFF BOXES WHEN ORDERING 100 DISKS OR MORE

10 Cap	£1.50
5 Cap	£1.15
1 Cap	£0.50

**SPECIAL OFFERS THIS MONTH
LOOK SAVE YOUR EYES**

12" or 14" COLOUR OR MONO FILTER SCREEN
SAVE YOUR EYES.....Only £13.99

12" or 14" TILT & TURN WITH HANDY KNOB
MONITOR STAND.....£15.95

A4 DESK TOP COPY HOLDER.....£8.00

PRINTER STANDS 5 DIFFERENT TYPES

PRINTER STAND (Feet)	
80 OR 132 COLUMN	£8.00
IBM PRINTER LEADS	£5.00
JOYSTICKS ALL MACHINES P/C	

LABELS 5.25" OR 3.5" (5.25 WITH W/P)
100 £1.00, 1000 £8.00
SINGLE OR MULTICOLOUR AVAILABLE



DUST COVERS

PC XT, AT+MONITOR	£6.00
12" or 14" MONITOR	£6.00
80 or 132 PRINTER	£6.00
LAZER PRINTER	£6.00
84 OR 102 KEYBOARD	£6.00
TOWER CPU	£6.00

CLEANING ACCESSORIES

MINI VACUUM CLEANER	£7.00
HEAD CLEANER 3.5" OR 5.25"	£2.50
MONITOR CLEANING SOLUTION	£3.00
ALL THE ABOVE & MORE	£11.00
3" CLEANING KIT	£3.00

DATA SWITCH BOXES

CENTRONICS OR SERIAL	
2 WAY	15.00
4 WAY	20.00
DATA SWITCH LEADS	8.00 each

SORRY! SORRY! SORRY!
WE DO NOT PRICE MATCH BUT WE DO
GIVE QUANTITY DISCOUNT, WITH SER-
VICE, QUALITY AND BACKING FROM
THE LARGEST DISK MANUFACTURERS
IN THE WORLD. IN ADDITION OVER 200
LINES OF PERIPHERALS IN STOCK. ASK
FOR OUR COLOUR CATALOGUE & PRICE
LIST WITH YOUR ORDER OR SEND 24p
S.A.E.

**CALL SAM OR PAT NOW!
ON 0753 553535**

BLUE BOX PRODUCTS
ALL BLUE BOX PRODUCTS ARE COMPLETELY PACKAGED IN
PRINTED CARDBOARD BOXES WITH LABELS. 100% GUARANTEED

BAMBI-2DD 1 MEG	MF-2DD 30's 1 MEG	MF-2DD 10's 1 MEG	M-2D 48TPI 10's	M-2DD 96TPI 10's
25 DSDD 3 1/2" IN 25	30 DSDD 3 1/2"	10 3 1/2" DSDD	10 DSDD 5 1/4"	10 DSDD 5 1/4"
CAP STORAGE BOX	1 BOX	1 BOX	1 BOX	1 BOX
1 BOX	£14.00	£6.00	£4.25	£4.75
2+	£13.00	£5.00	£3.75	£4.25
5+	£11.00	£4.50	£3.25	£3.75

BAMBI-2HD 2 MEG	MF-2HD 30's 2 MEG	MF-2HD 10's 2 MEG	M-2HD 10's 1.6 MEG
25 DSHD 3 1/2" IN 25	30 DSHD 3 1/2"	10 3 1/2" DSHD	10 DSHD 5 1/4"
CAP STORAGE BOX	1 BOX	1 BOX	1 BOX
1 BOX	£21.00	£8.50	£6.50
2+	£20.00	£8.00	£6.00
5+	£18.50	£7.00	£5.00

DATA CARTRIDGES	PRICE
DC 2000	£18.00
DC 300 XLP	£18.00
DC 600A	£19.50
DC 6150	£20.00
DC 6250	£21.00

FED UP WAITING?

**ALL ORDERS ARE NORMALLY DELIVERED
TO YOU WITHIN 48 HOURS**



If it wasn't hard enough flying underwater, there are bugs above me and a beady-eyed fish below. I hope I wake up to find it's all been a dream.



Ha! Take that in the shell, Brian. It's back to the cabbage patch for you, quisling.



Triumph and Volkswagen really missed out by not jointly producing the Stag Beetle. Still, I can take my revenge on this handsome specimen.

suckworthy graphics to make it an unmissable experience. And you can quote me on that.

Apidya



Everybody's talking about greenish shoes at the moment. Or maybe that's green issues. It's hard to tell. But never slow to jump on a bandwagon (as long as it's running on unleaded), the software people have adopted the eco-stance with alacrity.

Apidya gives you a wasp to fly. And fly it you must, through five levels of heavily populated microcosmic blasting action. Yes, it's a horizontal shoot-em-up. Everything you'd expect to see in such a game is here. You start off with a single forward-firing stream of, presumably, poisonous wasp-spit. It's enough to kill the bees, midges, mosquitoes and sub-coptic mange-mites which swarm onto the screen.

Greenfly-related nightmare

As you buzz along, wiping out hordes of nasties, you are given flowers (once you've killed the right amount). Collecting these is not only a rather sweet tribute to the tiny lives you've snuffed out during your fit of insectile genocide, but they also give you extra powers.



Level four has an incredible background. All the machinery turns, pumps, grinds plus various other machine-type moves, whilst the frantic bug-hunt continues in the foreground.

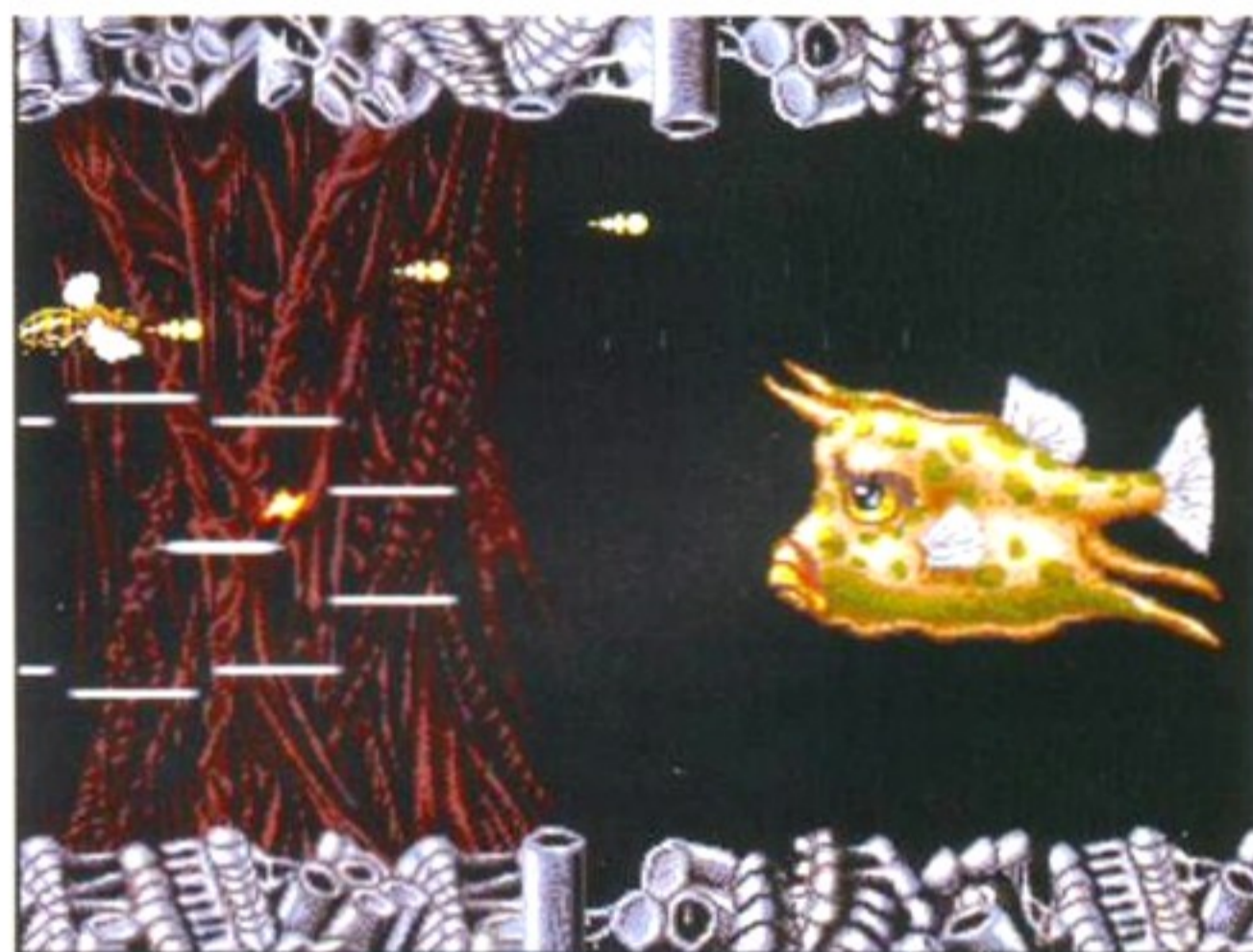

As in so many other shoot-em-ups, the collectables make you tougher and more resistant to the occasional contact with a nasty, and they give you three-way fire, huge bullets (or lumps of flob, whichever you choose) and a little drone (also punworthy) which orbits you, firing blindly into the oncoming bugs.

Of course, the payoff for all this pokiness is that you get to see some terrifyingly hard beasts. Quake in your shoes at the mere mention of the butterfly. Squeal in terror whilst trying not to think of the column of ants. Howl with ill-timed derision at the lethal snail.

This is the beauty of *Apidya*. Ordinary household pets such as bees, grasshoppers and pond-skaters are suddenly blown up to 50 times their actual size, and are doing their best to spray you with plasma-based laser death.

The game resembles a 'David Attenborough investigates the world of very small things' TV programme, but plays like *X-Out*. Storming playability combines with completely

Mid-level baddies are immensely tough, as you'd expect. This guppy thing also grows in stature every time you land a decent shot of him. His fire-power's not too weedy, either.

Waterboatman massacre

The only thing that counts against the game is that it might be too tough for all but the most callous-fingered gamer. Admittedly, whenever you lose a life, you do start within a few screens of where you died, but you lose all your extra power and weapons. This means that you could be stripped of about 80 per cent of your killing effectiveness. Not good when you're faced with a herd of suicidal fleas.

Time, though, will tell. The first level at least is easy to get on with, and you don't have to wait long before the completely gorgeous graphics start to manifest themselves in all their squidgy, squirmy glory.

Apidya is an excellent game. It deserves a Format Gold because, although it's a style we've seen a 100 times before, it looks so good, it plays beautifully and it's polished until it shines.

James Leach

Apidya Blue Byte ■ £25.99

- Graphics which will make you wish you had compound eyes.
- Smooth, controllable wasp has that elusive insect feel.
- A total of five very different levels, all with unique nasties.
- Gets difficult very quickly, and once you've lost one life, you've virtually lost them all.



DYNAMITE



NEW AMIGA A600

- ★ ON SITE MAINTENANCE
 - ★ SMART CARD FACILITY
 - ★ BUILT IN T.V. MODULATOR
 - ★ COMPACT HARD DRIVE OPTION
- A600 STARTER PACK.....**£364.95**
 A600 HD + 20 Mb HARD DRIVE.....**£459.95**
- ★ **AMIGA A500/PLUS PACKS** ★
- 1.3 STANDARD A500.....**£259.95**
 A500 PLUS STANDARD PACK.....**£309.95**
 A500 PLUS CARTOON CLASSICS.....**£324.95**

See our memory section to upgrade above

NEW AMIGA 1500 PACK

- FEATURING:
- ★ LATEST MODEL, INCORPORATING Workbench, Kickstart 2.0
 - ★ GETTING THE MOST OUT OF YOUR AMIGA (book)
 - ★ PLUS:- Home Accounts, Platinum Works, Deluxe Paint III, Puzznic, Elf & Toki
- £539.95**

LIMITED SPECIAL OFFER

- ★ UNBEATABLE MONITOR DEALS, SAVE £££S
- COMMODORE 1084S.....**£199.95**
 PHILIPS 8833 MKII.....**£199.95**
 GOLDSTAR TV/MONITOR.....**£159.95**
- + These prices are only applicable when a monitor is purchased with any Amiga. Add £15 if you wish to purchase them separately.

★ GREAT VALLEY PRODUCTS ★ 2 YEAR WARRANTY ★ HARD DRIVES ★

- A500:**
 SERIES II HD 8+ 52Mb.....**£334.95**
 SERIES II HD 8+ 105Mb.....**£439.95**
- A1500/2000:**
 SERIES II HC 8+ 52Mb.....**£264.95**
 (Configurations up to 420Mb
 8Mb RAM available please call)

NEW HARD DRIVE + ACCELERATOR THE ULTIMATE A500 EXPANSION PRODUCT!

- 40Mhz ACCELERATOR + HARD DISK DRIVE + *1Mb RAM
- A530 COMBO 40Mhz + *52Mb HARD DISK = **£659.95**
* Up to 8Mb RAM and 120Mb/240Mb versions available call now

★ PC 286 EMULATOR ★

- PC 286 16Mhz EMULATOR MODULE = **£219.95**
 For the series II and A530 hard drives
- Easy installation that does not invalidate your warranty

STEREO COLOUR MONITORS

COMMODORE 1084S £214.95	PHILIPS 8833 MKII £214.95
--------------------------------------	--

* CABLE TO YOUR COMPUTER ONLY £3.99 WHEN PURCHASED WITH MONITOR

★ DISK DRIVES ★

- ALL OUR DRIVES INCLUDE:
 TEN x 3.5" DISKS + 3.5" CLEANER KIT
FREE OF CHARGE!!
- + DIRECT A500 INTERNAL REPLACEMENT.....**£39.95**
 - + CUMANA CAX 354 Slimline design.....**£49.95**
 - + Power PC880E Featuring Anti-click device.....**£49.95**
 - + Power PC880B with Blitz/virus hardware.....**£69.95**

✚ This offer will run for a limited period only ✚

NEW A570/A670 CD-ROM DRIVE

- COMING SOON - ORDER YOURS NOW!
- A570 CDTV + INTERFACE For the Amiga 500 Plus.....**£269.95**
 A570 CDTV + INTERFACE Plus V.2 upgrade for A500 1.3.....**£314.95**
 A670 CDTV + INTERFACE For the Amiga 600.....**£269.95**

The above products are expected imminently so place your order now to avoid disappointment

KLONDIKE DEALS

DYNAMITE COMPUTERS
 DIG DEEP FOR
 THESE SPECIAL
 BARGAINS.....

★ CLEARANCE AMIGA SOFTWARE ★

- | | |
|---|--|
| + BACK TO THE FUTURE II..... £3.99 | + HOLLYWOOD COLLECTION..... £9.99 |
| + NIGHTBREED..... £3.99 | ADDICTED TO FUN..... £12.99 |
| + DAYS OF THUNDER..... £3.99 | ROBOCOP 3..... £12.99 |
| SHADOW OF THE BEAST II..... £4.99 | W.W.F..... £12.99 |
| CAPTAIN PLANET..... £4.99 | TERMINATOR 2..... £12.99 |
| LEMMINGS..... £4.99 | JIMMY WHITES SNOOKER..... £12.99 |
| BART SIMPSON..... £7.99 | OUTRUN EUROPA..... £12.99 |
| MEGLOMANIA..... £9.99 | ASTRA TEN STAR GAMES PACK..... £17.99 |

N.B * DENOTES NOT PLUS/A600 COMPATIBLE

COMPUTERS

THE PRICE BLASTERS

★ ART STUDIO★

Deluxe Paint II	£9.99
Spritz Paint	£9.99
Deluxe Paint III.....	£14.99
Fantavision.....	£14.99
Comic Setter	£19.99
Photon Paint V2.0.....	£19.99
Deluxe Paint IV.....	£54.99
Walt Disney Animator ..	£64.99
Professional Draw V.2. ...	£89.99

★ VIDEO STUDIO★

Vidi Amiga + Vidi Chrome ...	£69.99
Rombo RGB Splitter.....	£39.99
Take 2 Animation Package ..	£39.99
Complete Colour Solution...£	99.99
Colour Solution + Take 2 ..	£129.99
Rocgen Genlock	£84.99
Rocgen Plus Genlock.....	£129.95
Scala 500.....	£69.95
Scala (requires 1Mb)	£149.95
Roctec Genlock	£99.95

★ SOUND STUDIO★

Music X Junior	£19.99
Midi-Master Interface + 2 Midi Cables.....	£19.99
Music X 1.1	£49.99
Rombo Mega-Mix.....	£29.99
GVP Sound Studio.....	£49.95
Bars and Pipes	£89.95
Bars and Pipes Pro.....	£179.95

HOW TO ORDER



Call us NOW on
0234 214212



Send Cheque or postal order to
DYNAMITE COMPUTERS
Dynamite House
44a Stanley Street
Bedford MK41 7RW

NB Please write cheque guarantee card number on the reverse of cheque to ensure same day clearance (cheques without card number subject to 10 day clearance)

Call into our showroom for a fast and friendly service

Retail/Queries **0234 364428**

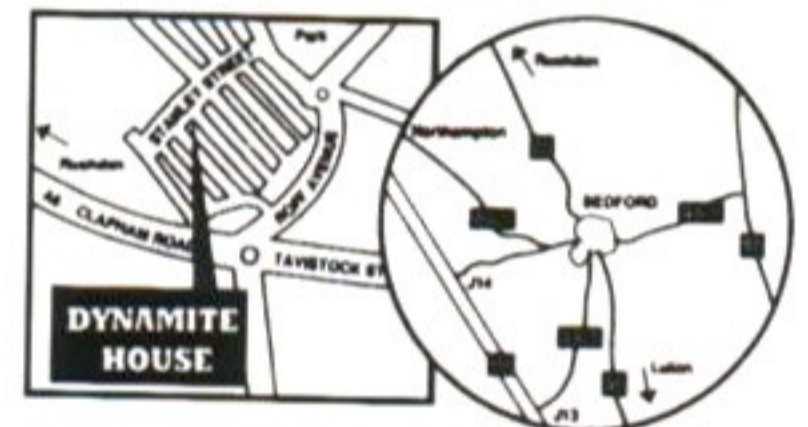

DELIVERY CHARGES*

£2.95 for orders less than £100
£4.95 for orders over £100
Next day express service £7.50

*Charges applicable to UK mainland only

PLATINUM SERVICE CARD

Only £19.99!

- Next day courier delivery
 - 30 day exchange for new
 - 1 year guarantee giving free collection and delivery should a fault occur.
- All prices subject to availability and may change without notice. E & OE

★ STAR/CITIZEN★ PRINTERS

CITIZEN 120D+	£109.95
STAR LC20.....	£119.95
CITIZEN SWIFT 9.....	£169.95
STAR LC200.....	£169.95
STAR LC24-20 (NEW).....	£179.95
STAR LC24-200 (MONO)	£199.95
CITIZEN 224	£209.95
STAR SJ48 BUBBLEJET.....	£214.95
STAR LC24-200 (COLOUR).....	£249.95
✦ CITIZEN SWIFT 24e.....	£264.95

✦ Complete with free colour kit whilst stocks last

ACCESSORIES

PARALLEL PRINTER CABLE.....	£3.99
UNIVERSAL PRINTER STAND.....	£3.99
200 SHEETS OF CONTINUOUS PAPER	£1.99
COLOUR KIT OPTION FOR SWIFT 9/224/24e	£34.95

★ POWER HAND SCANNER★

FEATURING:

- ★ LATEST VERSION 2 SOFTWARE
- ★ 64 GRAYSCALES
- ★ 100 - 400 DPI

PLUS FREE PHOTON PAINT 2.0 (RRP £89.95)

A DYNAMITE EXCLUSIVE AT £99.95

★ MEMORY ★

512K RAM EXPANSION (1.3).....	£15.95
512K RAM EXPANSION PLUS CLOCK.....	£19.95
1MB RAM EXPANSION (A500 PLUS).....	£29.95
1Mb by 8 or 9 SIMM boards (GVP)	£26.95
4Mb by 9 SIMMS (GVP)	£109.95
A500 RAM BOARDS (fully auto config/full thru' port)	
2Mb	£119.95
4Mb	£179.95
8Mb	£279.95

ACCESSORIES/EXTRAS

10 BLANK DISKS (3.5 DS/DD)	£3.99	ZIPSTICK SUPERPRO JOYSTICK	£9.99
50 BLANK DISKS (3.5 DS/DD)	£17.99	QUICKJOY TOP -STAR JOYSTICK	£14.99
QUALITY MOUSEPAD.....	£1.99	AMIGA SOFT DUSTCOVER	£3.99
40 CAPACITY LOCKABLE BOX.....	£2.99	AMIGA PERSPEX DUSTCOVER.....	£9.99
80 CAPACITY LOCKABLE BOX.....	£4.49	REPLACEMENT MOUSE	£9.99
ROLL OF 1000 3.5" DISK LABELS.....	£6.99	REPLACEMENT TV MODULATOR.....	£19.95
MOUSE/JOYSTICK Switcher box unit.....	£9.95	REPLACEMENT POWER SUPPLY.....	£29.95

TO PLACE YOUR ORDER PHONE THE DYNAMITE HOTLINE

0234 214212

DYNAMITE HOUSE, 44a STANLEY STREET, BEDFORD

STOP PRESS ● STOP PRESS ● STOP PRESS PUBLISHERS CHOICE SCOOP*

COMPRISES: TUTORIAL, KINDWORDS 2 (WORDPROCESSOR) PAGESSETTER + HEADLINE FONTS + ARTISTS CHOICE (EASY DTP)

This pack used to come with the Amiga 'Class of 90's' Pack but we've managed to source a few and are able to offer them at the giveaway price of **£19.95**

✦ N.B. This package is **NOT** Plus/A600 compatible

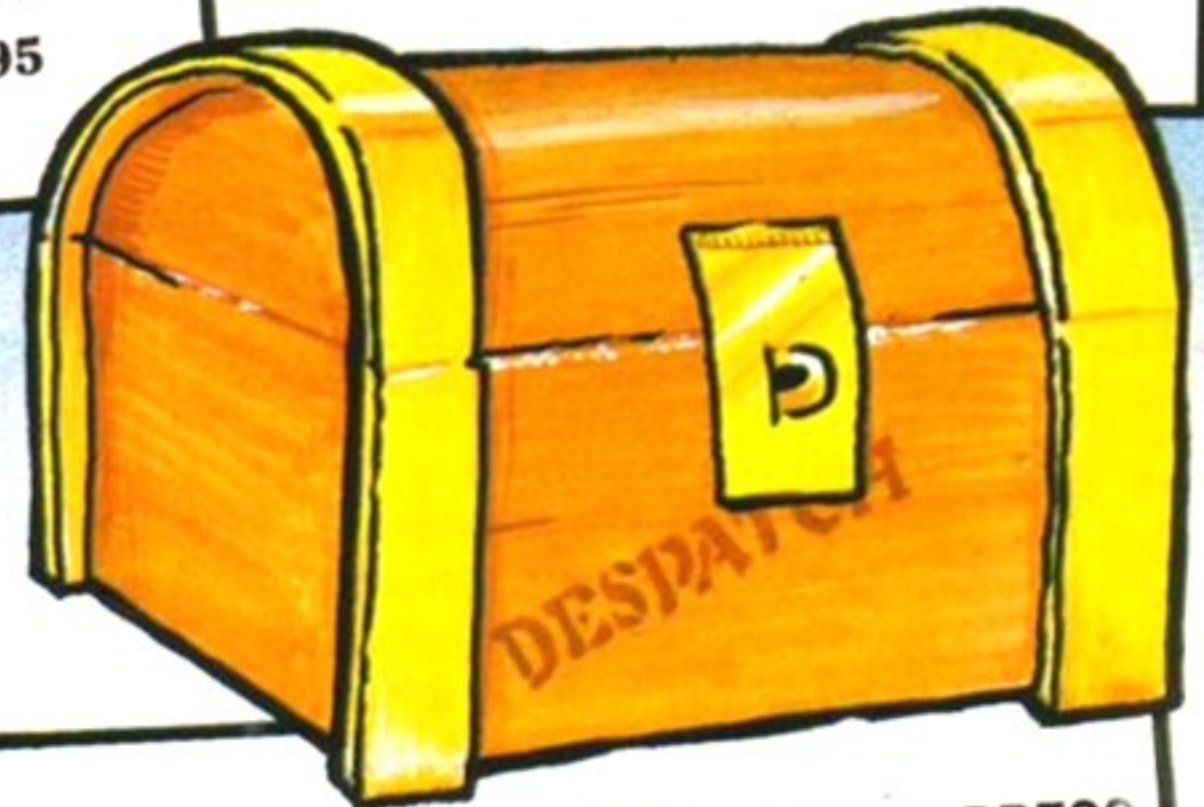

Alcatraz

This is the deal. The year's 1996 and Alcatraz has been taken over by some nasty chaps in a drug cartel. Your job is to capture the rotten dealers, burn the drugs and blow up the laboratories. This is carried out over four levels; the approach, the entrance, the clean out and the departure.

Essentially what we've got here is a revamp of *Hostages*. The game consists of one beat-em-up section (fight with knife or gun or hide), followed by a maze-like section, some abseiling and then a swift exit. Each of these sections manages to be suitably tense as you

can choose to either lay low or fight. The gloomy graphics add greatly to the sombre atmosphere and the clock in the top left-hand corner of the screen slowly ticks down your allotted two hours.

Either one or two players can play the game (simultaneously) and this is where the game really does come into its own. Each can help the other out or stand by dispassionately while they get their heads kicked in or underwear singed.

Your task is greatly helped by the number of spare weapons left lying around, although I

Johnny Biggins gets completely confused and throw a grenade at a vicious looking wall.

found it extremely difficult to actually change weapons; it's meant to be joystick up, but it doesn't work too well, mainly because you have to be in hiding before swapping. There are knives, flame-throwers, rifles, machine-guns and hand grenades all lying around ready for you to use. Of these, the flame-thrower is definitely the most useful as it manages to obliterate all enemies who happen to be on screen at any one time.

There's nothing too revolutionary about this game, but the two-player option is a lot of fun. There are some very nice touches in the game particularly when it switches to an *Operation Wolf*-style environment, and these lift its lasting interest considerably. If you liked *Hostages* (the game, not the news report), check this one out.



In the *Operation Wolf*-like section of the game, you've got to be extremely quick on the old trigger finger. Here player one is about to bite the dust, and player two won't be far behind. A swift grenade would have saved the day.

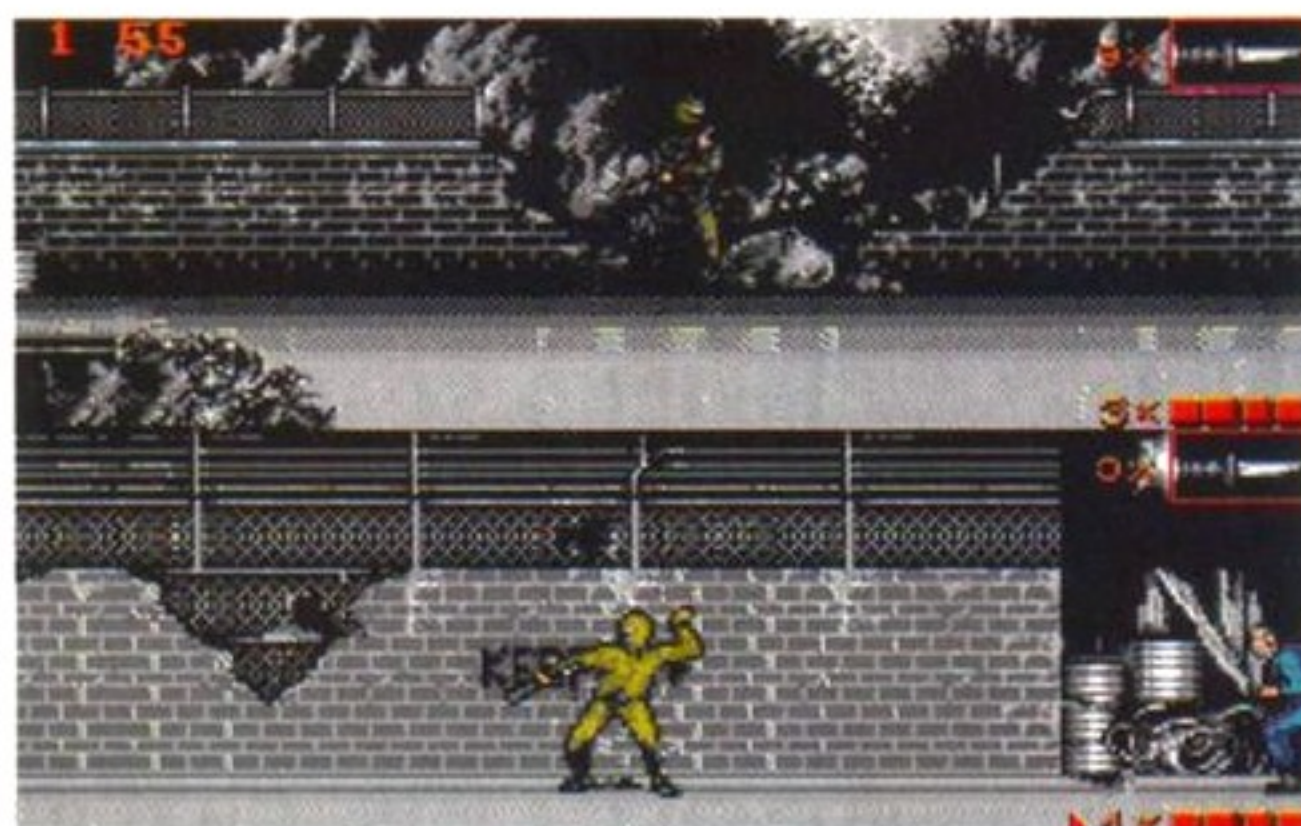

Alcatraz Infogrames ■ £25.99

- Atmospheric graphics and suitably clear sampled effects.
- Addictive and none-too-easy game.
- Changing weapons is far too much hassle.
- A very effective combination of really different game types.

Verdict 76%

AMIGA FORMAT

86

JUNE 1992



Hero Quest with Return of the Witchlord

Gremlin ■ £25.99

This RPG-for-the-masses bundle was reviewed first-time around in Issue 24, so Gremlin have had a whole year to put this data disk together. Return of the Witchlord is instantly accessible and extremely friendly. You can play by yourself or with up to four comrades, there are 24 levels and you can develop characters between games and then save them to disk. The graphics are small but smart. And those are the good points; the bad points are that everything relies on random dice throws, there's an annoyingly fiddly 2D view when you want to pick a fight, the results of battles are displayed before they're resolved, and there are no new features in the later levels.

Worst of all, it loses the board-game's best asset – you can't play the bad guys. The game's still pretty playable, especially with a group. Just don't expect anything spectacular.

Click on some icons, move around a bit and hope your number comes up – that's *Hero Quest*.

Verdict 60%



Ork

Psygnosis ■ £25.99

Now I really like this latest offering from those *Lemmings* peeps. Admittedly at first glance, and for the first couple of plays, it seems to be just another scrolling shoot-em-up. But as soon as you get into the feel of the game, you begin to realise that there's a helluva lot more to it.

You take on the role of the ork in the title, who is a would-be captain in the space fleet. Your mission then, is to complete a number of tasks to win those all-important epaulettes. Cleverly, though, you're not told what you have to do on each level – yes I'm afraid it's a case of wandering about, blasting the wildlife and looking for objects. To be honest, the puzzles aren't exactly going to tax your brains too much, and the game will often supply an, ahem, cryptic-ish clue if you do actually get stuck.

The real fun in the game comes from discovering (a) which bits of the background you can interact with, and (b) just what the quest for the level is. The thing is *Ork* does tend to get rather frustrating at times, mainly because the bad guys are particularly tenacious and you've only one life with limited energy, but who said the life of an ork was easy? A sleeper hit.

Can you outwit your enemies, solve the mysteries of life and eat a whole pig without chewing? Are you... a real ork?

Verdict 72%

The Manager

What this football management game has got (that every other one on the market has) is a truly bewildering range of options. In *The Manager* you can take part in every major European competition, train players up to the point of collapse and then conduct nifty deals on the transfer market to get rid of them, conduct the finances of the club.... well, any self-respecting footie management fan will know the list off by heart. So is there anything that makes this game different from all the others?



This is what the game is all about - poring intently over lists of numbers. As Kevin Toms was the man responsible for the original *Football Manager* back in 1982, I think we can lay the blame for the genre at his door.



For one thing, the presentation is agreeably polished. The friendly WIMP system ensures that playing is relatively painless – which is definitely a big plus when games can last hours. *The Manager's* big feature, though, is the fact that you can have up to four players in the game at once. Admittedly, the level of interaction that you can have between them is fairly minimal (it's usually limited to arranging loans of players or money) but the possibility

The traditional "animated match highlights". You can't influence them in any way, yet still they remain unbearably tense and exciting. Why is this? Nobody knows.

of knocking your best friend out of the Cup adds that extra edge to the game.

OK, *The Manager* probably won't make fans out of the unconverted and for all the clever presentation it's really just another juggle-the-numbers simulation glossed over. Having said that, though, it's by far the best one that I've seen. If you've got the inclination and the stamina, the game will give you months of enjoyment.

The Manager
US Gold ■ £30.99

- Extremely detailed and subtle gameplay.
- It's well presented and relatively easy to pick up the general rules.
- You'll need lots of time and some dedicated friends to get the best out of it.
- At heart the game's just another collection of number lists.

Verdict 79%



Vengeance of Excalibur

Virgin Games ■ £29.99

In which Shadowmaster steals Excalibur and the Holy Grail then buggers off to sunny Spain. Arthur is understandably upset by this and sends four knights off to retrieve his mantelpiece ornaments before they get scratched or something. You then control these four knights on their quest to Benidorm, however unfortunately there's no option for beating the German tourists to the sunbeds. Hey, xenophobia, don't you just love it?

Yes you've seen it all before. There's woggles of disk accessing, a few pretty static screens, the odd map bit, a spot of picking things up, some mild strategy and some terrible medieval puns. There's no "Insert disk 3" here, instead you get witty little messages like "Place square medallion number four in any magic box." Do me a favour. No doubt the American market will just love this game (xenophobia again?). I however found it twee, boring and largely naff. Cut your toe nails instead.

Verdict 64%



Agony

Psygnosis ■ £25.99

For no reason other than plot, your character, Alestes, has been transformed into an owl. In order to prove your worthiness to succeed your wizardly mentor, you have to conquer six levels of horizontally-scrolling shoot-'em-up action, although I use the word 'action' in the untrue sense of the word.

The game's graphics are sumptuous enough and incredibly detailed, with animated parallax backgrounds and some beautiful sprite animation. No doubt the grand piano intro track is a work of art, but the crashy, staccato in-game music is, to be polite, a mistake. Sadly there's even more bad news; the gameplay just isn't there. And I don't mean it isn't quite 'there', it actually doesn't exist.

You keep your finger held down on the fire-button, waggle the joystick around and occasionally cast a spell. There's no excitement, no addictive qualities whatsoever and at the end of the day no game. You would have thought that Psygnosis had learnt its lesson after *Shadow of the Beast* and *Shadow of the Beast II*, but no, all the ironically titled *Agony* seems to be is a £26 demo that looks like a peacock but plays like a stoat.

Verdict 60%



Samurai - The Way of the Warrior

Impressions ■ £29.99

For one meg Amigas only, though half meg owners aren't going to miss out on much. Samurai is set (shock horror) in 16th century China, when local warlords ran the land and the samurai was the ultimate warrior. Unfortunately, in this game he's been transformed into a tactician and commander. Don't expect much in the way of blood and guts.

Typical of an Impressions game, this is stuffed chock full of all sorts of options for building up an army and moving them about to fight other armies. If you're idea of fun is to spend the first 30 minutes of gameplay, simply moving little blobby icons back and forth and then another five or ten watching them meander across a battlefield then you'll adore this game. Graphically it's fine, but I died of boredom appreciating them.

Early Samurai used to carry their lunch around in Tupperware before the horrid plastic smell put them off and they resorted to bamboo and wicker.

Verdict **65%**



Super Ski 2

Microids ■ £25.99

Not quite in time for the Winter Olympics, but despite missing the band wagon here's six events, all involving high-speed descents over ice or snow. The downhill skiing gets three events (there's simple downhill, slalom and then the giant slalom) all of which involve swishing down a very steep hill and moving your little man through a series of blue and red gates. If you miss a gate then you get either a penalty point or a tree in the face, one is probably preferable to the other. Also included are ski jumping (very tricky event), the hot-dog (nope, not risking eating one, but performing twists and jumps in the air) and the bobsleigh (don't forget to jump on after you've push-started it).

The graphics are fairly simplistic and the sounds aren't exactly going to burn out your monitor's speaker, but there's definitely some fun to be had here. Your best bet is probably to get some mates around and go for the four-player option. There's nothing better than a bit of competitive spirit and this sort of game to bring out the very worst in people. Guaranteed to cause at least two head kickings and a minor brotherly beating up.

Then disaster struck. Some fool had planted red and blue flags all over the downhill course.

Verdict **70%**

Competition Time! Competition Time! Competition Time!

Can you take the full force?

So do you fancy yourself as a bit of a hard-nut? In fact how would you like a chance to prove to the world that you're made of very stern stuff indeed? Well, to commemorate the launch of their *Special Forces* action-strategy game (check out the review on Page 57) MicroProse are offering **Amiga Format** readers an all-expenses-paid, weekend trip to the Acorn Activities Centre in Pembrokeshire. This challenging outdoor pursuits centre is the place where you can have a go at abseiling, rock climbing, canoeing, caving and a whole host of other strenuous, at-one-with-the-wilderness type sports.

To win the activity weekend of a lifetime, all you have to do is answer the three not-so-difficult questions listed here and send them in to the address on the right. The first correct answer that is pulled out of the hat gets to go along absolutely free – and even has the option of which weekend to attend. So come on, have a go, if you think you're hard enough!

The Questions:

- Which larger-than-life General led the American forces in Kuwait?
(a) Gen "Last-stand" Custer
(b) Gen "Stormin'" Norman Schwarzkopf
(c) Gen "Chris" Patten
- What is SAS an abbreviation for?
(a) Stop and Surrender
(b) Special Army Soldiers
(c) Special Air Services
- What is the name of the famous British pilot captured by Iraq?
(a) John Peters
(b) Peter Johns
(c) Biggles

Got it?

Then send your answers (and your name, address and phone number) on a post-card or the back of a sealed envelope, to:

I Wanna Leap Off A Cliff
Amiga Format
30 Monmouth Street, Bath,
Avon BA1 2BW



Risk life and limb! Challenge the world! Prove to your mum that you're not a wimp. Enter the MicroProse *Special Forces* Competition and climb the rope of success!



"Squad, atten-shun! So, you reckon you're the greatest thing since sliced bread, huh? I've seen more special forces working for the Sally Army. Get yourself along to training, you 'orrible shower!"

Special Orders

1 This competition is NOT open to employees of either Future Publishing or MicroProse. Anyone found breaking this rule will be shot as a spy.

2 Entries written on the backs of £5 notes or blank cheques will be used to buy vast quantities of alcohol and sticking plasters

3 All entries must reach us by Friday 19 June.

NOW A FULL COLOUR HANDY SCANNER FOR YOUR AMIGA

AT AN UNBEATABLE PRICE!!

FOR ONLY **£199.99**

- The NEW Datel Colour Scanner uses the Mustek 8 colour grey scale head to produce 4096 colour images.
- Several modes of operation are available to give 8, 16 or 32 different colour and Ham images as well as 16 grey scales.
- Scan update direct to the screen with direct scrolling and positioning of the scanned image.
- Full colour palette control with Gamma correction.
- Save IFF or Raw files of screen or buffer.

- Runs in 640 x 256 or 320 x 256 screen display.
- Unit plugs into expansion port of Amiga and does not require external power unit..

HIGH RESOLUTION BLACK & WHITE HANDY SCANNER AT AN EVEN LOWER PRICE!

- NEW** IFF Buffer Save 1600 x 1024 pixels, dual buffer, scan matching & view Buffer.
- Unmatched edit/capture facilities & keyboard control not offered by other scanners at this special price.
- NEW** Full keyboard control of most functions.
- An easy to handle Handy Scanner featuring 105 mm scanning width & 400 dpi resolution enables you to scan graphics/text into your Amiga.

- NEW** Includes hard disk transfer to run under Workbench.
- Adjustable switches for brightness/contrast levels.
- NEW** Full sizing menu of scan area.
- Geniscan gives you the ability to scan images, text or graphics & even offers 200 Dpi Dual Scan Mode.
- NEW** Screen grid overlay & configure menu to save parameters. Icon menu to select functions.

- NEW** X, Y position readout & metric sizes.
- Save images in suitable format for most leading packages including PHOTON PAINT, DELUXE PAINT, etc.
- NEW** View window and position control panel.
- Powerful partner for DTP that allows for cut and paste editing of images etc.

COMES WITH **FREE PHOTON PAINT**

NOW ONLY £99.99

• Package includes Handy Scanner, Interface, Power Pack and Scan Edit IV software.

GENIUS DIGITIZING TABLET

ADD A PROFESSIONAL TOUCH TO YOUR DRAWING/CAD WORK

- With the Amiga Genitizer Graphics Tablet you can streamline the operation of most graphic or CAD programs.
- The Genitizer Graphics Tablet utilises latest technology to offer up to 100 dpi resolution at the tip of a stylus.
- Complete 9" x 6" digitizing area plus super accurate stylus combine to enable fast, accurate and easy control.
- Works by "mouse emulation" so the Genitizer will work with most packages where mouse input is the usual method - Deluxe Paint, Photon Paint, CAD Packages, etc.
- Supplied with a template for Deluxe Paint.
- Full easy to follow instructions.
- This is the input method used on professional systems - now you can add a new dimension to graphics/CAD.
- Fast input of drawing by "tracing" is made easy - plus "absolute reference" means you can move around the screen many times faster than by a mouse.
- The Genitizer fits in the serial port of your Amiga 500/1000/2000 and "co-exists" with mouse.
- Unlike a mouse, the Tablet gives absolute co-ordinates so that tracking and menu selections are possible from the tablet face.

- A pressure sensitive switch built into the stylus tip activates the Tablet overriding the normal mouse input. When you are not using the Tablet, you have normal mouse control.
- Complete system - Graphics Digitizer Tablet, Stylus, Deluxe Paint Template, Power Adaptor, Test Software, Interface Unit, plus Driver Program - no more to buy!

NOW ONLY **£129.99**



OPTIONAL PUCK
As an alternative to the stylus input the Genius Tablet also has an optional four button puck. Ideal for tracing etc. **ONLY £29.99**

GOLDEN IMAGE OPTICAL REPLACEMENT MOUSE

... NOW A TRUE OPTICAL MOUSE! FOR THE AMIGA

- YES A FULL FEATURE OPTICAL MOUSE FOR YOUR AMIGA - THAT MEANS NO MOVING PARTS!
- Incorporating full optical tracking and counting - no ball so no problems with clogging, slipping, etc.
- High count output for very fine movement.
- Two button microswitch action.
- Comes complete with special "Optical Pad".
- Superbly styled - supersmooth shape moulded to fit the hand.
- Comes complete with moulded 9 pin connector. No more to buy!!

COMPLETE **ONLY £39.99**

GENIUS MOUSE

- High quality direct replacement for mouse on all Amigas.
- Teflon glides for smoother movement.
- Rubber coated ball for minimum slip.
- Optical system counting - 500/mm.

COMPLETE WITH ALL ACCESSORIES **ONLY £19.99**

DATTEL
Electronics
LIMITED

HOW TO GET YOUR ORDER FAST!

TELEPHONE [24Hrs] **0782 744707** CREDIT CARD ORDERS
ORDERS NORMALLY DISPATCHED WITHIN 48 Hrs. ALL CHEQUES/POSTAL ORDERS MADE PAYABLE TO...



DATTEL ELECTRONICS



GOVAN ROAD, FENTON INDUSTRIAL ESTATE, FENTON, STOKE-ON-TRENT,
ST4 2RS, ENGLAND. FAX 0782 744292 TECHNICAL/CUSTOMER SERVICE 0782 744324

DATTEL LONDON SHOP



222, TOTTENHAM COURT RD,
LONDON, W1. TEL:071 5806460

ACTION

REPLAY

THE WORLD'S CARTRIDGE IS

NOW WITH A MASSIVE IN ROM OFFERING MK III

JUST LOOK AT THE UNMATCHED RANGE OF FEATURES

● SAVE THE ENTIRE PROGRAM IN MEMORY TO DISK

Special compacting techniques enable up to 3 programs to fit on one disk. Now saves directly to disk as Amiga Dos - reloads independently of the cartridge - even transfer to hard drive! Works with up to 2 Megs of Ram - even 1 Meg Chip Mem (Fatter Agnus).

● SUPER POWERFUL TRAINER MODE -

NEW now with **DEEP** trainer. Even better than before - allows you to generate more or even infinite lives, fuel, ammo. Perfect as a Trainer Mode to get you past that "impossible" level. Easy to use.

● IMPROVED SPRITE EDITOR

The full Sprite Editor allows you to view/modify the whole sprite set including any "attached" sprites. PLUS A RANGE OF IMPROVED FEATURES.

● VIRUS DETECTION

Comprehensive virus detection and removal features to protect your software investment. Works with all presently known viruses.

● BURST NIBBLER.

NEW Now this super disk copier program is built into Action Replay Mk III. Just imagine a superfast, efficient disk copier program at the press of a key - no more waiting.

● SAVE PICTURES AND MUSIC TO DISK

Pictures and sound samples can be saved to disk. Files are saved directly in IFF format suitable for use with all the major graphic and music packages. Samples are displayed as screen waveform.

● PAL or NTSC MODES SELECTABLE -

NEW Useful for removing ugly borders when using NTSC software. (Works only with newer Agnus chips).

● SLOW MOTION MODE

Now you can slow down the action to your own pace. Easily adjustable from full speed to 20% speed. Ideal to help you through the tricky parts!

● MANY MORE INSTANT CLI COMMANDS -

like Rename, Relabel, Copy, etc.

● RESTART THE PROGRAM

NEW Simply press any key and the program will continue where you left off.

● FULL STATUS REPORTING

At the press of a key now you can view the Machine Status, including Fast Ram, Chip Ram, RamDisk, Drive Status, etc.

● POWERFUL PICTURE EDITOR

Now you can manipulate and search for screens throughout memory. Over 50 commands to edit the picture plus unique on screen status "overlay" shows all the information you could ever need to work on screens. No other product comes close to offering such dynamic screen handling of frozen programs!!

● JOYSTICK HANDLER -

NEW allows the user to select Joystick instead of Keypresses - very useful for many keyboard programs.

● MUSIC SOUND TRACKER

With Sound Tracker you can find the complete music in programs, demos, etc. and save them to disk. Saves in format suitable for most track player programs. Works with loads of programs!!

● AUTOFIRE MANAGER

From the Action Replay III preference screen you can now set up autofire from 0 to 100%. Just imagine continuous fire power? Joystick 1 and 2 are set separately for that extra advantage!

● IMPROVED RAM EXPANSION SUPPORT.

NEW Now many more external Ram Expansions will work with all Action Replay III commands.

● DOS COMMANDS

Now you have a selection of DOS commands available at all times - DIR, FORMAT, COPY, DEVICE, etc.

● FILE REQUESTOR -

NEW if you enter a command without a filename, then a file requestor is displayed.

● DISK COPY

Disk Copy at the press of a button - faster than Dos Copy. No need to load Workbench - available at all times.

● BOOT SELECTOR

Either DF0 or DF1 can be selected as the boot drive when working with Amiga Dos disks. Very useful to be able to boot from your external drive.

● PLUS IMPROVED DEBUGGER COMMANDS -

including Mem Watch Points and Trace.

● DISKCODER

NEW With the new "Diskcoder" option you can now 'tag' your disks with a unique code that will prevent the disk from being loaded by anyone else. 'Tagged' disks will only reload when you enter the code. Very useful for security.

DATTEL
Electronics
LIMITED

HOW TO GET YOUR ORDER FAST!

TELEPHONE [24Hrs] **0782 744707** CREDIT CARD ORDERS

ORDERS NORMALLY DISPATCHED WITHIN 48 Hrs. ALL CHEQUES/POSTAL ORDERS MADE PAYABLE TO...



DATTEL ELECTRONICS



GOVAN ROAD, FENTON INDUSTRIAL ESTATE, FENTON, STOKE-ON-TRENT,
ST4 2RS, ENGLAND. FAX 0782 744292 TECHNICAL/CUSTOMER SERVICE 0782 744324

DATTEL LONDON SHOW



222, TOTTENHAM COURT ROAD
LONDON, W1. TEL: 071 58064

ON REPLAY

MOST POWERFUL FREEZER-UTILITY

NOW EVEN BETTER!!

STILL ONLY

£59.99

AMIGA A500/500+ FOR 1500/2000 VERSION £69.99

THE 256K OPERATING SYSTEM A WHOLE NEW RANGE OF FEATURES

AMIGA ACTION REPLAY SIMPLY PLUGS INTO THE EXPANSION PORT OF YOUR AMIGA AND GIVES YOU THE POWER TO FREEZE MOST ANY PROGRAM



NEW SET MAP -

allows you to Load/Save/Edit a Keymap.

● PREFERENCES

Action Replay III now has screen colour preferences with menu setup. Customise your screens to suit your taste. Very simple to use.

NEW IMPROVED PRINTER SUPPORT -

including compressed/small character command.

● DISK MONITOR

Invaluable disk monitor - displays disk information in easy to understand format. Full modify/save options.

PLUS A MACHINE CODE FREEZER MONITOR WITH EVEN MORE POWER!!

MORE FEATURES INCLUDING 80 COLUMN DISPLAY AND 2 WAY SCROLLING...

- Full M68000 Assembler/Disassembler
- Full screen editor
- Load/Save block
- Write String to memory
- Jump to specific address
- Show Ram as text
- Show frozen picture
- Play resident sample
- Show and edit all CPU registers and flag
- Calculator
- Help command
- Full search feature
- Unique Custom Chip Editor allows you to see and modify all chip registers - even write only registers!
- Notepad
- Disk handling - show actual track, Disk Sync. pattern etc.
- Dynamic Breakpoint handling
- Show memory as HEX, ASCII, Assembler, Decimal
- Copper Assemble/Disassemble - now with suffix names

REMEMBER AT ALL TIMES YOU ARE INTERROGATING THE PROGRAM IN IT'S "FROZEN" STATE WITH ALL MEMORY AND REGISTERS INTACT - INVALUABLE FOR DE-BUGGING OR JUST THE INQUISITIVE!

WARNING 1988 COPYRIGHT ACT WARNING

Date! Electronics Ltd., neither condones or authorises the use of it's products for the reproduction of copyright material. The backup facilities of this product are designed to reproduce only software such as Public Domain material, the users own programs or software where permission to make backups has been clearly given. It is illegal to make copies, even for your own use, of copyright material, without the clear permission of the copyright owner, or the licensee thereof.

VIDEO DIGITIZER II



NOW YOU CAN DIGITIZE PICTURES FROM ANY VIDEO CAMERA OR VCR

- Completely re-designed interface that plugs into the expansion connector of the Amiga 500 or internal connector of the Amiga 2000.
- Standard phono video input 0.5 to 2.0 volts to take signals from TV, video or camera.
- Controls for brightness and contrast and throughport on A500 version.
- Frame grab in 1/50 second, record update up to 3 frames per second.
- Single or continuous mono update in 4, 8 or 16 grey levels.
- Play frames backwards or forwards up to 15 frames per second.
- Save Raw, IFF or sequence files.
- Automatically adjust for maximum number of frames according to memory available.
- Display 256 x 256 pixels, but optional 320 x 256 IFF Save. Screen editing features Cut, Copy, Brush, Paste and Undo.

- Second display editor controls sequence production: Record, Play, Insert, Clear, Delete Frames.
- Effects menu to reverse pos/neg, compress, etc.
- Set start and end position number of frames saved, number frames, step backwards and forwards, loop, etc. Time lapse feature adjustable in 1 second increments to 1 hour between each frame. Ideal for capturing flowers opening, sky movements, special effects, etc.
- Separate player programs included to insert into your own program disks. Hard disk transfer program.
- Please state whether you require the A500 or 2000 version when ordering.

**All For Only
£89.99
COMPLETE**

100%... VALUE
100%... FEATURES **AMIGA FORMAT**
"At the price, the picture quality and wide range of features is almost unrivalled!"

8833 Mk 2 MONITOR

- Fully compatible Stereo Monitor.
- 14" screen - RGB Composite inputs.
- Free Amiga lead. ● Ready to go!!

Only £199.99 + £10.00 carriage.

PROTAR VISTO C14MI

Improved version of 8833 Mk II.

Only £209.99 + £10.00 carriage.

A500 DUAL PORT EXPANDER

- Allows two devices to be connected simultaneously to your A500/+ Expansion Port (compatibility allowing).
- Ideal for A590 owners, effectively giving Thru Port.
- Top quality connectors.

**Only
£19.99**



ROM SHARER



- Some older programs will not run with the new Kickstart 2.04. Datel now brings you this unique Rom Sharer to allow you to switch between Kickstart 1.3 and 2.04.
- Easily fitted - no more to buy.

Only £24.99

DIGITAL DISPLAY DRIVE

- Top quality 1 Mb unformatted drive.
- Built in digital display actually shows which track is accessed.
- Attractively styled to suit all Amigas.

**Only
£59.99**



MEMORY UPGRADES

512K UPGRADE

- Fully compatible - brings A500 up to 1 Meg.
- Simply plug into trapdoor - does not affect warranty.



- Fitted with disable switch.

Without Clock £19.99
With Clock £24.99

2 MEG UPGRADE FOR YOUR A500 PLUS

- Simply plug in to upgrade your A500 Plus to a full 2 Megs of Chip Ram.
- Take advantage of the Advanced Graphic Power of your Plus.

Only £44.99

RAM MASTER

- Upgrade your A500 to a full 2 Megs
- Easily fitted to trapdoor and Gary chip.
- Onboard clock - auto recharging.
- Fully populated with Fastram (requires Kickstart 1.3).

Only £79.99

NEW MINI SAMPLER



- A top quality 8 bit mono sampler complete with Pro Sampler and Jammer software.
- Also compatible with most other PD Sampler software.
- Inputs for microphone or line 3.5mm jack and din connections.
- Utilises latest surface mount technology and incorporates all the features found on bigger, more expensive samplers.
- Easy to use - just plug in and start sampling!

Only £24.99
COMPLETE PLEASE STATE
A500/1000/2000/1500

AMIGA PRO SAMPLER STUDIO II + DATEL JAMMER

- New design hardware now plugs into expansion socket of A500 completely freeing the parallel port.
- Surface mount technology, twin A/D converters for realtime stereo sampling.
- Extensive filters for extremely clean and noise-free sampling.
- Through bus allows existing add ons, e.g. hard drive.
- The NEW Sampler II software has been completely re-written in 100% Machine Code and incorporates faster routines, bigger displays and many new editing features such as Cut, Copy, Insert, Replace, Mix, Erase, etc.
- Separate zoom windows and controls for left and right channels.
- Multi-bank facilities for 1 Meg users.
- Stereo lock control.
- Adjustable trig record level and sound monitor.
- Separate buffer for editing waveforms and improved wave-editor with instant update.
- Save files in Raw or single, multi-octave IFF format.
- Envelope control panel for ramping up and down re-scale amplitude, noise filter and scan waveform.
- On screen display of filenames sample rate, length, etc.
- Inputs for microphone or line 1/4" jack and DIN connections at rear of unit.

Only £49.99 COMPLETE (A500)
INTERNAL 2000/1500 VERSION ALSO AVAILABLE

**REALTIME
STEREO
SAMPLING**

MIDIMASTER

- Midi In - 3 x Midi Out & Midi Thru.
- Full Midi Interface for A500/1000/2000 (please state which model req.).
- Fully Opto isolated.
- Compatible with all leading Midi packages (In D/Music).

Now Only £19.99
INC. 2 FREE MIDI CABLES

INTERNAL MIDI INTERFACE

- Now an internal interface for the Amiga 2000 and 1500.
- Easily fitted in minutes.
- Leaves serial port free for other uses.
- Midi In, 3 x Midi Out and Midi Thru.
- Fully compatible - Opto isolated.

Only £29.99
INC. 2 FREE MIDI CABLES

MICROMIDI

- MIDI In - MIDI Out - MIDI Thru.
- Fully Opto isolated.

**Now Only
£14.99**



DATEL
Electronics
LIMITED

HOW TO GET YOUR ORDER FAST!

TELEPHONE [24Hrs] **0782 744707** CREDIT CARD ORDERS

ORDERS NORMALLY DISPATCHED WITHIN 48 Hrs. ALL CHEQUES/POSTAL ORDERS MADE PAYABLE TO...



DATEL ELECTRONICS



GOVAN ROAD, FENTON INDUSTRIAL ESTATE, FENTON, STOKE-ON-TRENT,
ST4 2RS, ENGLAND. FAX 0782 744292 TECHNICAL/CUSTOMER SERVICE 0782 744324

DATEL LONDON SHOP



222, TOTTENHAM COURT RD,
LONDON, W1. TEL:071 5806460

REAL TIME Colour VIDEO DIGITIZER

CAPTURE REAL COLOUR IN REAL TIME!



NOW DATEL BRING YOU THE FIRST REALTIME COLOUR VIDEO DIGITIZER FOR UNDER £200!!

- NOW, BY USING CUSTOM CHIP TECHNOLOGY, YOU CAN GRAB A PICTURE FROM ANY VIDEO OR CAMERA SOURCE - NO NEED TO PAUSE THE PICTURE - NO NEED TO USE FILTERS.
- Grabs 15 Bit colour image in 1/50 second, double buffered display updates at 5 frames per second full screen or 15 frames per second in monitor mode.
- Display 8, 8+, 16, 16+, 32, 32+, Red, Green, Blue, B/W and HAM.
- 24 Bit IFF file save from 15 Bit data plus visual IFF colour save modes.
- Screen display is 256 x 256 pixels in normal mode, 128 x 128 pixel monitor mode or optional 320 x 256 save mode.
- Editing features include Cut, Copy, Brush, Paste and Undo, palette controls include R.G.B. level and Gamma correction.
- Special effects mirror, reverse pos/neg compress etc.
- Standard phono video input 0.5 to 2.0 volt composite sync level from video/camera etc.
- Hardware consists of main digitizer unit with brightness and contrast controls and R.G.B. splitter unit featuring Red, Green, Blue and Saturation controls.
- Unit plugs into expansion connector of Amiga 500, with through port for hard disk drives.

OPTIONAL MOVIE MAKER SOFTWARE

- Movie Maker uses the monitor mode of the Real-Time Digitizer to record and playback.
- 128 x 128 pixel 32 colour images at rates between 1 to 15 frames per second.
- Full editing facilities to record, play, single, step, cut, paste, clear, etc.
- Play, loop, forward or backwards controls plus time interval feature for up to 1 hour between frames.
- Uses chip or just memory up to 6 meg to give 500 frames. This gives you a 1 minute movie at 8 frames per second.

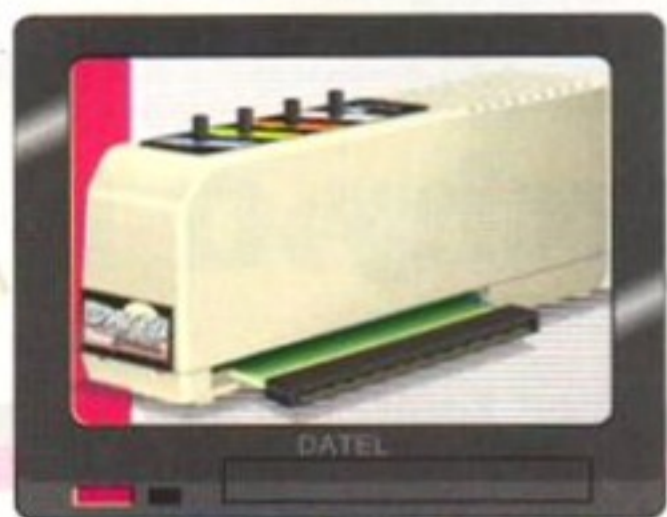

ONLY £ **199⁹⁹**

OPTIONAL MOVIE MAKER SOFTWARE

ONLY £ **19⁹⁹**

DATEL
Electronics
LIMITED

HOW TO GET YOUR ORDER FAST!

TELEPHONE [24Hrs] **0782 744707** CREDIT CARD ORDERS

ORDERS NORMALLY DISPATCHED WITHIN 48 Hrs. ALL CHEQUES/POSTAL ORDERS MADE PAYABLE TO...



DATEL ELECTRONICS



GOVAN ROAD, FENTON INDUSTRIAL ESTATE, FENTON, STOKE-ON-TRENT,
ST4 2RS, ENGLAND. FAX 0782 744292 TECHNICAL/CUSTOMER SERVICE 0782 744324

DATEL LONDON SHOP



222, TOTTENHAM COURT RD,
LONDON, W1. TEL:071 5806460



Cheap 'n' Cheerful

Don't buy into zinc at the moment. Avoid trading in oil, gold or plutonium. Pull out of those mega breadhead corporations. Budget software is where all the smart money's going at the moment. As well as **James Leach**...

AMIGA FORMAT

94

JUNE 1992



Errggh. Gwplff. I think I'm getting seasick. This has got to be the worst Channel crossing since Captain Webb covered himself with lard and collided with a Swedish frigate.

Hoversprint

CodeMasters ■ £7.99

It's a small step from crossing the Channel to racing around various tortuous circuits. Rather surprising that nobody has managed to come up with the idea of pitting hovercraft against each other before. Anyway, the Codies are giving you a very special, once-in-a-lifetime chance to compete in a small hover vehicle against several other, er, craft.

It's a pretty quick 3D affair, is *Hoversprint*, with a very low-down view. The hovering bits are pretty irrelevant; it may as well be in racing cars with very smooth suspension and incredibly skiddy wheels, but the 3D is certainly nicely done, and the computer opponents are no push-overs. There are 20 circuits, ranging from short and fast to long, bendy and frightening. But you only get three opponents, which doesn't make for much inter-pack jostling, and the game really does lack a gimmick (for want of a better word) which could possibly bring the whole thing alive.

In its favour, though, there is a neat RS232 link option, so you can actually race another human. And I'm sure by now, everyone must know just how much fun modem-linked games are, so this is basically the best thing I can find about *Hoversprint*.

Verdict 67%

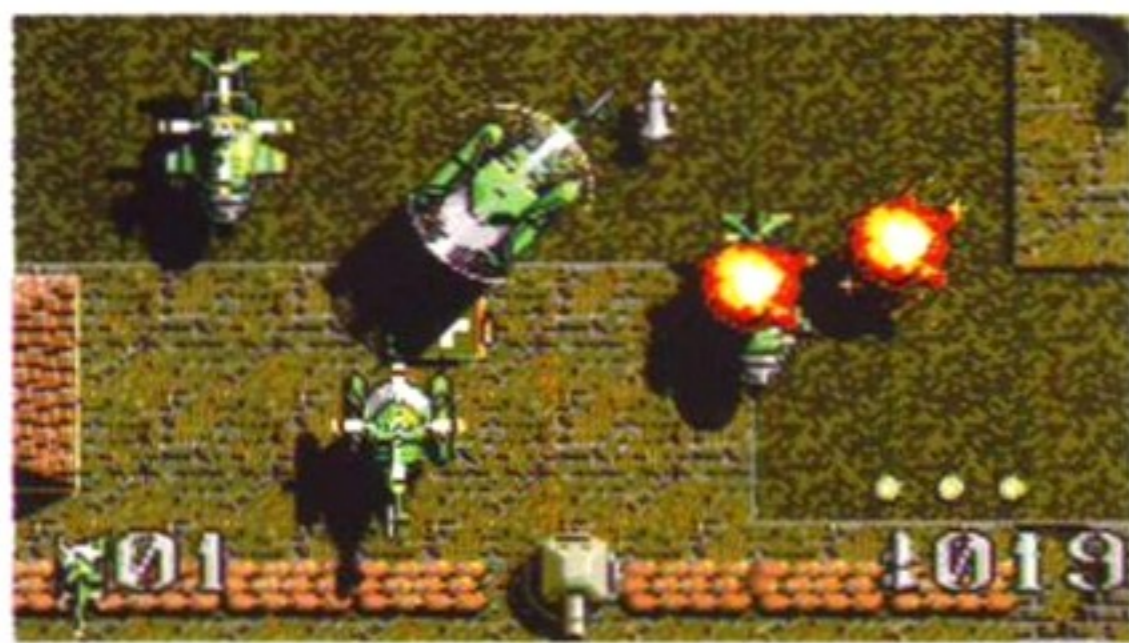

That's "apache" explosion effect if ever I saw one! (Pun courtesy of the Chaucer Press, Shetland).

Apache Flight

Atlantis ■ £7.99

Don't be expecting a flight-sim like *Thunderhawk*. Be expecting a vertical-scroller which plays like half of *SWIV*. *Apache Flight* is a traditional blaster which sees you dodging bullets, shooting bullets and collecting more powerful bullets.

It starts off slowly, but if you plug away for long enough it gets fairly respectable. What is intensely annoying, though, is that many of the ground units that fire at you don't succumb to your return blasting.

As well as firing missiles and bombs, you need to refuel occasionally. This mundane bit of domesticity is either a welcome break from the carnage (if you're a fuel-fan) or an intrusion into the quite fast and slightly furious gameplay.

Overall, it's playable, but where's the jeep?

Verdict 69%



Don't you hate drivers who hog the outside lane when there's nobody in the other two? Still, a quick shunt up the exhaust should see him right for a spell in *Intensive*.

Lotus Esprit Turbo Challenge

GBH Gold ■ £7.99

Lotus Challenge scored a massive 89 per cent (**Amiga Format** 17) when it was released on the full price last year. Since then, as all abiding readers will know, it's been overshadowed by racing games like MicroProse's *Formula One* which not only puts it in the shade, but positively locks it in a darkened room.

Gremlin have also released the sequel, *Lotus Challenge II*, but don't despair because you can still have immense fun with the original – but there's no four-player mode or modem link. *Lotus Esprit*, though, has quite exceptional smoothness, speed and a large number of identical Lotuses all belting round at speeds calculated to get you rather enraged.

For £7.99 (a fraction of the cost of a proper Lotus) you get a real feel for the car; you can skid the back-end out, stamp on the brakes for pit-stops and overtake your amusingly-named opponents on the straight bits. It's as addictive as driving a real Lotus (I should know. I have three).

Verdict 87%

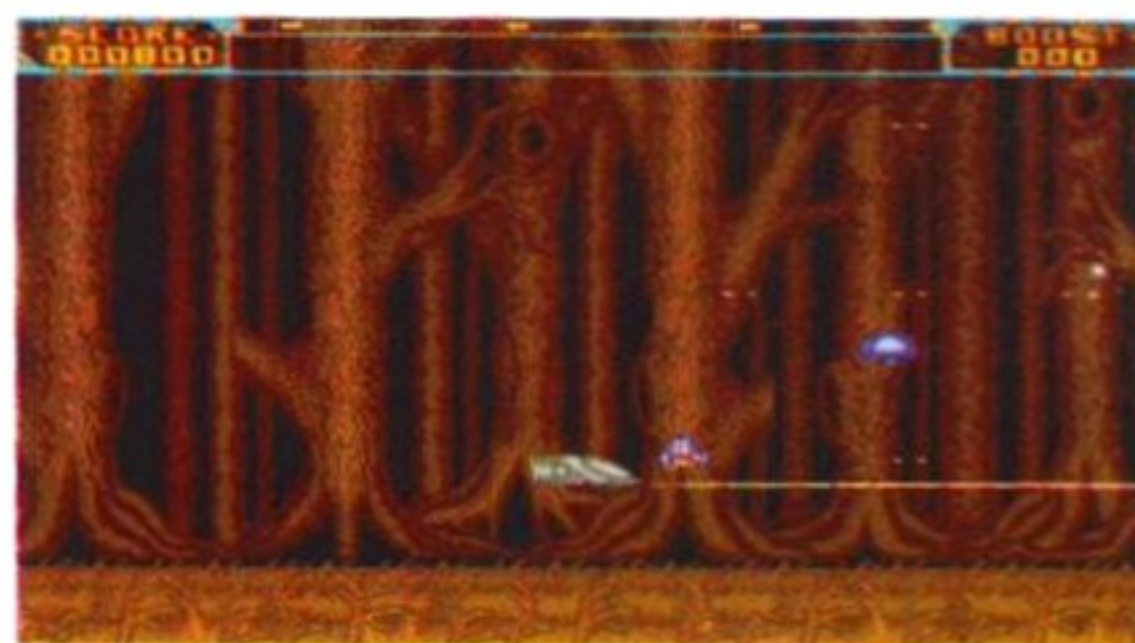

Anarchy is a good game, but it's actually about as anarchic as joining the police force and maintaining law and order in Wokingham on a Friday night.

Anarchy

Action 16 ■ £7.99

Burn public buildings! Remove road-signs! Shout meaninglessly at policemen! Or rather don't, because it's illegal. Play *Anarchy* instead. It's a pretty decent version of that gnarled and dribblingly senile old 'fave', *Defender*.

You scroll your ship from side to side, shooting long lines at the baddies, which you've picked up on your radar. Once you've killed them all, do it again with some more (and some nicer backgrounds).

It's pretty true to the original *Defender*, but that was only good because there was nothing better at the time. Luckily *Anarchy* has been jazzed (and speeded) up sufficiently to make it rather more 'now'. If you've got to have a *Defender* game, have this one.

Verdict 76%

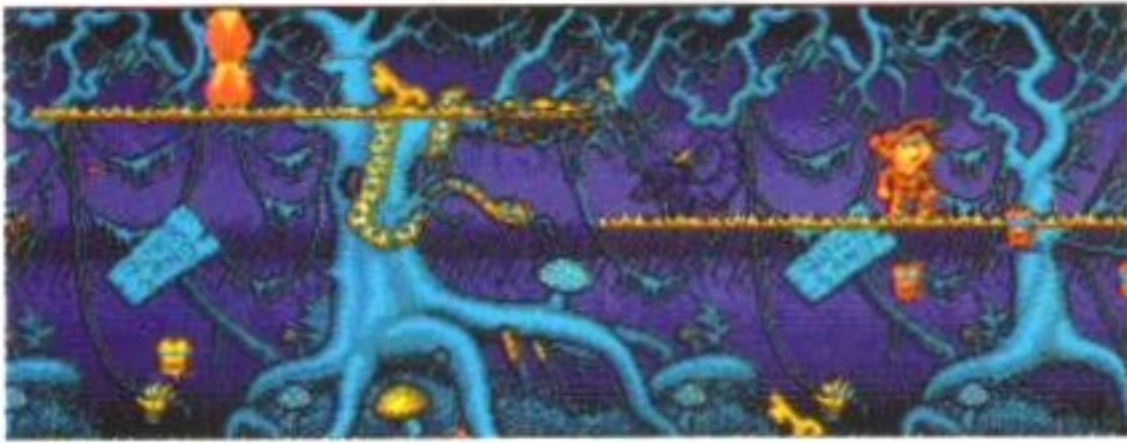

It's bright, it's colourful and it appears to have Andy Capp as the star. *Spellbound* dares to tackle the supernatural issues which confront us all in our daily humdrum lives.

SpellBound

Sizzlers ■ £7.99

Here we have eight levels of 'mystical magic-orientated action'. This translates to mean a platform game with some colourful explosions and wiggly lines.

You play a cloth-capped figure who must rescue his master. On the way, you must collect spells and objects, kill any animals lower down the food-chain and work out various puzzles. If you believe in magic, you might be astounded. The rest of us cynics will simply see a colourful platformer which is competent, but doesn't go anywhere new. "It's got a two-player option, though!", I hear you cry. And you'd be right. How did you know?

Verdict 51%

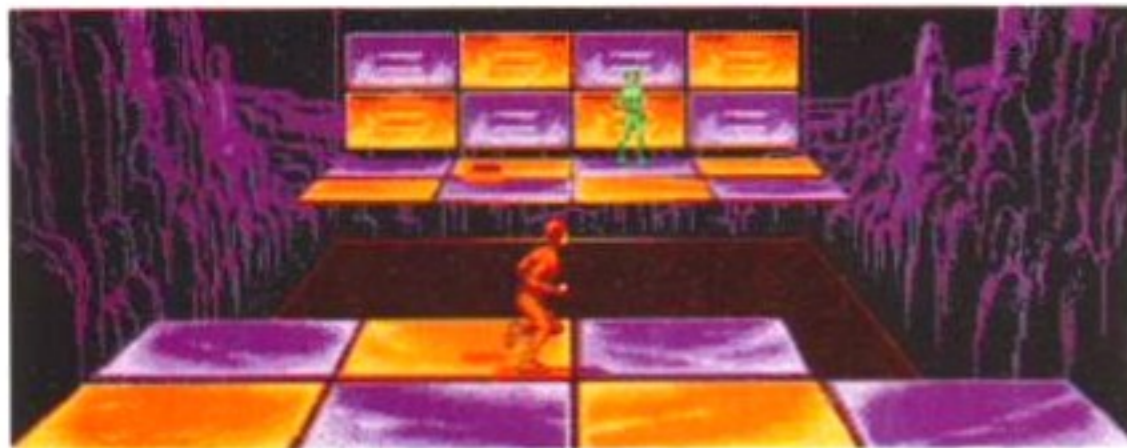

The only sounds that the audience could hear were the grunts of the contestants and the underarm chafing of the lycra, Jill Gascoigne-look catsuits.

Disc

Action 16 ■ £7.99

Futuristic gladiator nonsense ahoy! A strange game in which you stand on some coloured squares and throw metal frisbees at people called Nuke, Nitro and Timothy in an attempt to murder them. The emphasis is on running around quickly, catching your frisbee and avoiding the evil frisbee of the other guy. You're not supposed to fall off the platform, either.

Strange game, this. The programmers seem to have made up for the lack of variety in the game by adding in loads of Cyberpunk *Speedball*-type stuff.

Verdict 48%

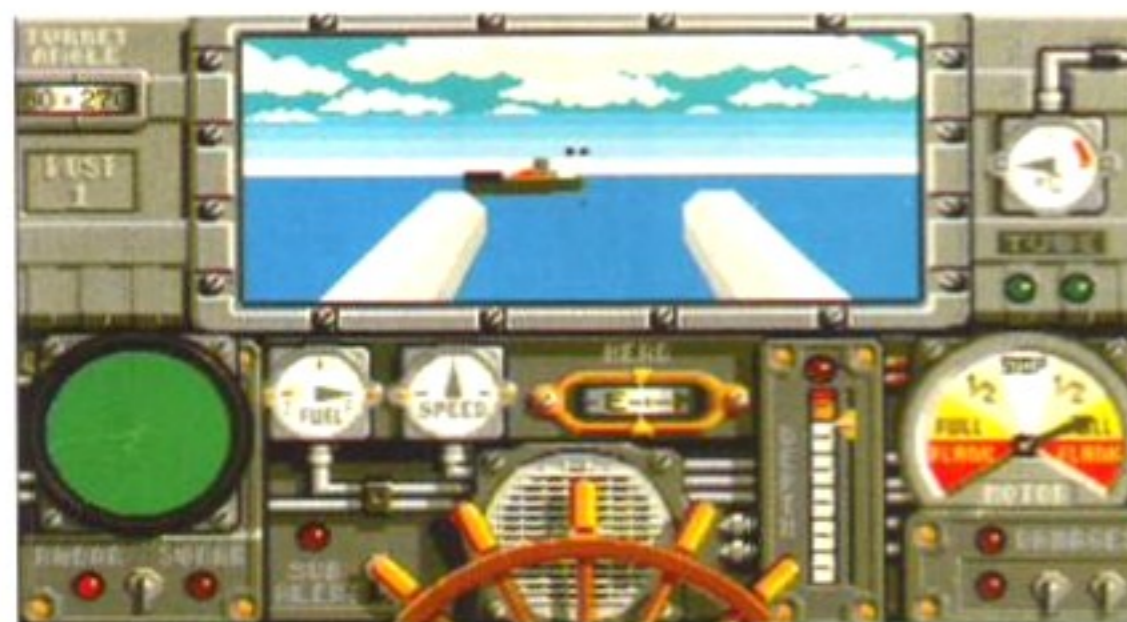

"Lady Ghislaine off the port bow, skipper." Yes, life is never dull aboard HMS Pinochet, as she majestically sinks yachts and frightens off the numerous heavily armed 45,000-ton Italian escape craft.

Advanced Destroyer Simulator

Loricel ■ £7.99

Ideal for those who like to have a little tug in the bath, *ADS* is a 3D mini *Silent Service* sort of game. You bob around the Med, shooting unarmed Italian tankers. Then you meet a heavily-armed Italian cruiser. So you cling to a congealed lump of untreated human waste and watch your destroyer sink.

It's fast, not too difficult and rather enjoyable. Plenty of data screens, maps and 3D views and a fair bit of tactical planning. You'll have as much fun as you do in the tub.

Verdict 67%

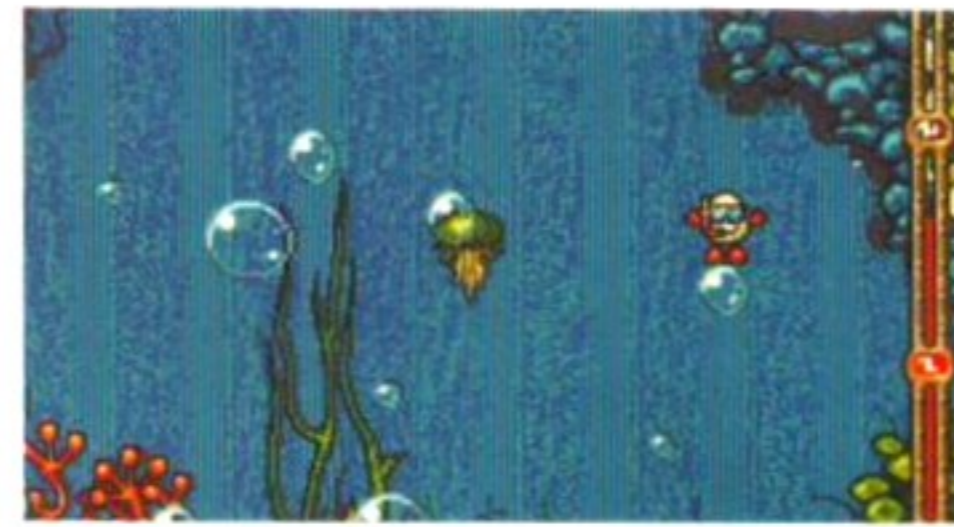

You can't expect an egg to be put in boiling water without some sort of psychological side-effects. Especially if you later cave his head in with a spoon and scoop out his innards.

Dizzy's Excellent Adventures

CodeMasters ■ £24.99

Spellbound Dizzy is a new game in which you romp along various side-viewed screens, looking for things to help you get even further into it. The game contains hundreds of different screens. *Dizzy - Prince Of The Yolk Folk* is much the same with different (ish) characters.

Panic Dizzy is a *Tetris*-like puzzler. Different shaped things drop from the sky, and you've got to put them into corresponding slots. *Kwik Snax* is another puzzler. Finally, *Bubble Dizzy*. The egg must jump from bubble to bursting bubble to escape from a boiling underwater hell.

Verdict 77%

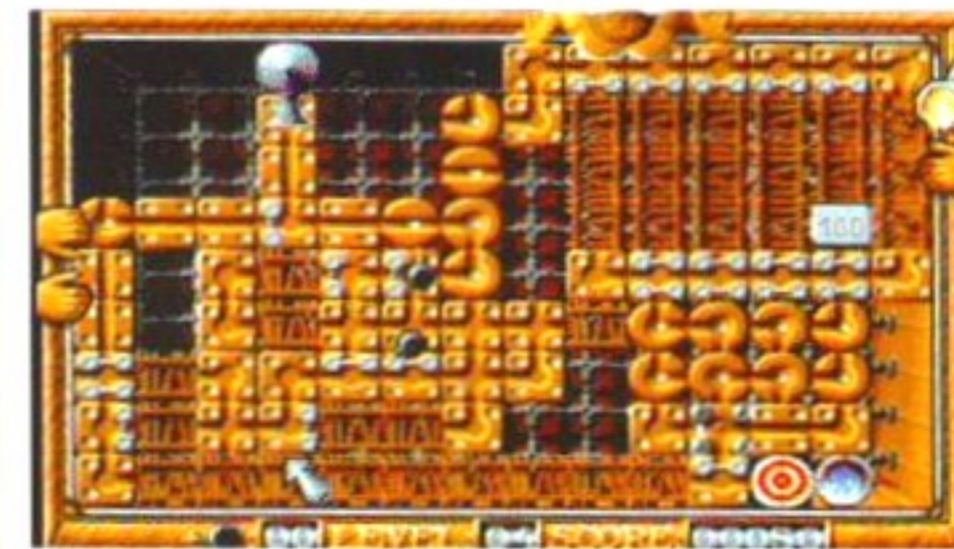

Their tenuous grip on reality finally gives way, and the *Boston Bomb Club* are left with a screen in which two bombs roll around various swivellable gutters.

Fantasy Pak

Silmarils ■ £19.99

Colorado is a mixture of arcade action, puzzling fiendishness and strategy headaches. You search a dim fantasy land looking for an Indian gold mine in the Wild West. Not bad, if a little dilettante. *Boston Bomb Club* is a puzzler like *Pipemania*, looks good and plays well.

Crystals Of Arborea lets, nay begs you to wander through an illuminated fantasy land, controlling your team who are after the four magic crystals of Harmony (the hairspray people). Nice graphics, stodgy gameplay and, of course, at least one evil Lord of Chaos. It's better than *Colorado I*.

Verdict 68%



There go Senna and Prost. Perhaps by travelling at 20km/h I'm erring on the side of caution. *Drat*. That means I'll have to engage second gear.

Grandstand

Domark ■ £29.99

Gazza's Super Soccer is the tale of one man's trip to has-beenland. It's a poor *Kick Off 2*, but it's playable and fast. Sort of like real football. *Continental Circus*. Exciting and tough, you've got to race 99 other folk around the circuits of the world. More arcade than sim.

World Class Leaderboard calms you. It's 3D golf with all the trimmings. Select your club, look at the nice graphics and try and land in the water so you can hear the amusing plop sound. It's not half-bad. *Pro Tennis Tour*. It's dead tough, but it's quick, responsive and it looks quite nice.

Verdict 88%

olly. A large Compilation Corner. And it's not corner-shaped.

PUBLIC DOMINATOR - Public Domain, Shareware, Licenseware for Amigas. 27,000 satisfied customers world wide.

Send Cheques & P.O.s to:
Public Dominator AF
PO Box 801
Bishops Stortford
Herts CM23 3TP UK.



0279 757 692

9.30am-5pm Monday-Saturday
Credit Card Orders/General Enquiries.
Send a stamped S.A.E. for a FREE printed catalogue.
All orders dispatched same day by 1ST class post.



GAMES

ARCADE CLASSICS - A 4 disk pack full of nostalgic arcade games including Space Invaders, Asteroids, Pac Man, Missile Command, Breakout and Qiz. Code GPA1 - £10.00

ARCADE PACK 2 - A 4 disk pack with more excellent arcade attacks with titles, Pipe Line, Air Ace 2, Organic Horror, Gore Blasters and Escape From Jovi excellent! Code GPA3. £10.00

BOARD GAMES 1 - A mega 4 disk compilation of classic board games includes Back Gammon, Five In A Line, Chess, Tiles, Flipper, Amigo, China Challenge, Master Mind, Amiga Tron, Up and Down, Triangle and Triple YachtZ. Order Code GPA4. £10.00

CARD GAMES 1 - A 4 disk pack full of card games that includes Card a Rama, Spades, Black Jack, Solitaire X, Klondike Solitaire, Canfield, Solitaire and Cribbage. Order Code GPA5. Only £10.00

PSL1 - SPACE BLOB is a brilliant platform cavern game. £3.00

PSL2 - MR DIG, collect the apples and kill the monsters. 1MB. £3.00

PSL3 - Q-BOID shoot blocks at the various random shapes descending. £3.

PSL4 - COMPUTER CONFLICT brill speech, graphics all action arcade game. 1MB. £3.

PSL5 - SUBCULTURE a shoot 'em up. £3

PSL7 - DIZZY LIZZY a game across between Pacman & Boulderdash. £3.

PSL15 - CRYSTAL CAVERNS 1MB. £3.00

DV5 - JUNGLE BUNGLE adventure in the jungle for children. 1MB RAM. £3.50

DV6 - PUKADO avoid the badies as you empty the screen of tiles. £3.50

DV7 - 4 WAY LYNX a 22 level tile puzzle game. 1MB RAM. £3.50

DV11 - GO GETTER an excellent board game that will keep you occupied for hours! Req. 1MB RAM. £3.50

DV16 - REVERSI II based on the board game Othello. 1MB RAM. £3.50

DV17 - DOG FIGHT II a brill aerial shot'em up. 1MB. £3.50

DV19 - X IT 50. A shoot 'em up. £3.5.

DV21 - QUINGO an excellent quiz game where you answer questions and play bingo. 1MB RAM. £3.50

DV27 - FLOWER POWER can you grow plants flower show? 1MB. £3.50

DV3 - GALLEONS ship to ship combat as equal to Dogfight II. 1MB. £3.50

DV39 - MAGIC FOREST II. 1MB. £3.50

DV43 - LAZERZONE. 1MB. £3.50

DV44 - FORMULA I CHALLENGE. 1MB. £3.50 Team Management.

AMU15 - BULL RUN US civil war simulator.

AMU14 - BATTLE TECH a strategy wargame between robots.

PD90 - TENNIS and excellent implementation of the sport. 1MB.

PD79/80/81 - STAR TREK by Twisted Images. Full graphics and sounds. 1MB 2 Drives £9.00.

PD215/216 - STAR TREK by Agatron. Full graphics, sounds & animation from new generation Star Trek. £6.00

SMAUG 156/157 - STAR TREK by Jimbo Barbers a brand new game. 1MB 2 drives. £6.00. Full graphics, sounds

PD0M 679 - STAR TREK THE NEXT GENERATION V1.47 by T McIntosh.

PD681 - LLAMATRON by Jeff Minter A mega blast them to pieces.

PD682 - POMPOM GUNNER is a Pearl Harbour game.

PD683 - SEA LANCE is a highly classified stealth submarine GAME.

PD690 - REVENGE OF THE MUTANT CAMELS blast them to pieces.

PSL 20 - AVINA BLUE A superfast horizontal scroller. £3.

PSL 21 - CHALLENGE of the MATRIX a brilliant tiles game. £3.

PSL 22 - SPECTRUM a blast away at the advancing aliens. £3.

SMAUG 149 - MORIA V3.0 excellent full graphics adventure! 1MB.

PD233 - HOLY GRAIL adventure. 1MB

PD234 - GOLDEN FLEECE adventure.

DV49 - 1MB. MARVIN THE MARTIAN a maze game. £3.50.

DV58 - 1MB. LOCKS, KEYS and ENEMIES Arcade game. £3.50

DV60 - 1MB. TECHNO SNAIL all the baby snails have been stolen and you have to rescue them. £3.50.

DV61 - 1MB THE FINAL CHAPTER. A brilliant 3D game! £3.50

DV62 - REVOLUTION a game 2 to 4 players. £3.50.

DV63 - 1MB WILBERTS WINTER WONDERLAND. £3.50.

DV64 - RESCUE II A 3D game. £3.50

DV66 - HOTEL MANAGER a good board game full of colourful graphics. £3.50.

DV67 - CYADONIA. 1MB follow up to CYAD with improved graphics. £3.50.

ANIMATION DEMOS

SCHWARTZ ANIMATIONS

FF413 - SWISS ARMY F-16 In Combat, Stealthy Manuever II, Juggette. 1MB.

FF414 - BATMAN, LateNight Terminal.

FF417 - COYOTE 2. The Road Test.

FF418 - AMY the Squirrel. 1MB

FF423 - POGO to Mam'a'selle. 1MB

FF450 - AMY Vs Walker. 1MB

FF490 - ANTI LEMMING 2MB

FF504 - SHUTTLE COCK 1MB

FF505 - THE DATING GAME 3MB

FF617/618 - BEACH 2MB. £6.00.

PD667/668 - AMY v Walker 2. 3MB. £6.00.

PD669/672 - AMY at the Movies 2. 1MB 2 drives or 4MB. £12.00.

PLUS OTHERS

SMAUG 132 - TELLSTAR One A long animation of 2 space ships very good quality. 1MB RAM.

SMAUG 135 - MARS FLIGHT a single seater space fighter flying over scenes from a habitated planet supposedly Mars. Requires 1MB.

SMAUG 136 - TWILIGHT a car with headlamps on driving along a road in a landscape. 1MB

SMAUG 146/147 - DR ZORB II. 2MB RAM. The amazing Dr Zorb. £6.00.

SMAUG 150 - JET aircraft flying around a silver shiny ball inside a bubble. 1MB.

PD1 - WALKER I. Star Wars. 1MB RAM.

PD2 - WALKER II. Star Wars. 1MB RAM.

PD73 - STAR TREK Enterprise Dry Dock.

PD74 - STAR TREK space craft flying around in a circle.

PD76 - STAR TREK Shuttle landing on the SS Enterprise.

PD427 - STAR TREK Leave Space Office.

PD83 - SPACE ACE. Excellent.

PROGRAMS

AMP7 - PERSONAL FINANCE PACK, this pack contains 11 programs that will handle just about every aspect of your personal finances. Bank & BS account, Loans & Mortgages. £8.50!

PD499 - AMBASE V3.7.6 database.

FF611/616 - TeX V3.1 the document processor and typesetting tool comes on 6 disks only £16.50!

FF619 - AMI GAZER V3.0 the latest version of the Astronomy star gazing program with details on 1573 stars.

FF543 - BADGER V2.05a reminds you of any important events that are 'due'.

FF372 - MAGNETIC PAGES V1.0 allows you to create a disk-based magazine.

PD674 - DEMOLISHER Disk 5 contains 207 utilities.

FF387 - BOOT in NTSC or PAL if you have 1MB Agnus chip installed.

FF425 - A-GENE V3.1 an excellent genealogy database. 1MB RAM

FF536 - CHEMESTHETICS V2.06 draws molecules using the calotte model

FF429 - SCRUB spins drive for 30 seconds for use with disk cleaner.

FF434 - TYPING TUTOR.

AMP1 - HOME BUSINESS PACK. Text Plus the excellent wordprocessor and spellchecker, Visicalc the spreadsheet, RIM & JBase 2 brilliant databases. £8.50!

PD416 - NCOMM V1.9. ALL you need for communicating via the phone line.

FF533 - BOOT GEN V3.4 creates menu for any 10 programs on booting

FF527 - PICBASE V3.6 organise all IFFpics display many on screen at once.

FF517 - CWIOY learn morse code.

FF494 - INPUT LOCK V1.1 lock/unlock keyboard with keystroke.

AMP4 - STARTER UTILITY PACK for the new Amiga user to give you just about every utility that you probably will ever need PLUS the word processor Text Plus which will allow you to write a shopping list or a book! and the Database JBase which

will allow you to store information on your disk about ANYTHING from a wedding list to a name and address file! The utils include 4 file compressors, disk copier, Dir Work the graphic interface for CLU. Virus detector and killer. Mouse utilities many more. £8.50!

FF366 - PRINT STUDIO V1.2 print any text file or picture & control printer.

TB6 - BIO RHYTHMS life cycles

TB9 - FASTMEM allows you to toggle ON/OFF your expansion RAM. Funckey assign commands to keys F1 to F10.

TB16 - CU WIZARD V1.2 is the mouse operated CU replacement.

FF559 - ADDRESSER a name, addr, tel database with labels + mailmerge

TB30 - MYMENU create your own menu on WB. Icon Meister editor.

FF342 - IE the icon editor that allows you to create icons upto 640 x 200!

FF568 - CALORIE BASE caloric and fat count on most foods useful for recipes and daily total intake.

PD300 - MASTER VIRUS KILLER V2.1 recognises 124 virul

PD641 - SUPER KILLERS anti virus disk recognises & destroys 146 virul

TB31 - SHOWWZ show any picture with or without your own controlling script.

PD93 - ARP V1.3 the Amiga DOS Replacement Project.

PD680 - EMULATORS by Cryptic UK has the following OK. computer emulators. PC, ST, MAC requires additional hardware. QL, CPM plus DOS to DOS

PD691 - 600 BUSINESS LETTERS just about every conceivable letter that you could want to send.

PD692 - IBM TRANSFORMER V3.00 a by Mr Face an IBM PC emulator that requires DOS on disk and is very good!

PD695/696 - WINDOWS BENCH V1.0 by Mikesoft a brilliant Work Bench replacement. £6.

PD697/698 - SUPERBENCH and extras a good Work Bench replacement. £6.00.

FF228 - JAZZBENCH v0.8 is a multitasking WorkBench replacement

FF558 - DISDF stops drive clicking when no disk in drive.

FF251 - DISK SAIV V1.42 more powerful than Disk Doctor this utility will attempt to salvage data from bad disks.

PD304 - MESSYDOS handles MSDOS/ST formatted disks. Plus DirWork

FF243 - PASSWORD V1.2.1 you specify the password for your system security

FF279 - MRBACKUP V3.3 backup your hard disk to floppy fast and secure.

FF561 - SUPER DUPEP disk duplicator.

FF555 - FLASH a brilliant multitasking disk copier that handles nibble.

AM122 - PRINTER Driver Generator an easy to follow way to create a driver for your printer. Simply enter the correct codes from your printer manual.

FF495 - ANALYTICALC the powerful spreadsheet. 1MB.

LANGUAGES

PD211 - NORTH V1.3 fully featured C compiler, linker etc.

FF503 - PCQ pascal compiler fully featured pascal compiler.

FF470 - BCF Fortran 77 V1.3c excellent fortran compiler.

FF519/520 - OAK LISP. Brilliant 2 disk version of Lisp. £6.00.

FF456/457 - C MANUAL V2.0. A book on 2 disks about C on the Amiga with 100 example programs and source code. Goes indepth in a straight forward way about all aspects of programming the Amiga in C. £6.

GRAPHICS

AMP3 - GRAPHICS PACK 1. Moad, ROT3D drawing program, VDraw the painting program, Raytracer plus utilities. Clip III, FilterPix, screen and window to disk savers, icon editors and more. £8.50.

AMP21 - GRAPHICS PACK 2. Mse Mandelbrot explorer, Alari ST & Apple Mac to IFF converter, PopColours, picture viewers. PolyGon, VIZ and KAL allow you to create weird screen displays. DBW Render raytracing. £8.50.

PD502 - C LIGHT Ray Tracing. A brilliant but basic ray tracing package for you to create amazing graphics!

DV35 - T-TEC DRAW produce excellent high quality Technical drawings with printer option. 1MB. £3.50.

DV36 - FRACGEN II brilliant fractal generator. Very easy to use. £3.50.

DV40 - SPRITE BANK Ed. Use with AMOS sprite bank manipulation. £3.50.

DV42 - X-STITCH prints an IFF picture in the form of a Cross stitch pattern for embroidery. £3.50.

FF523 - SCREEN JAEGER searches memory for any graphics and allows you to save or print the image or just look at on screen.

EDUCATION

AMP5 - OVER 10's EDISOFT PACK includes 2 excellent map drawing programs of any location on earth. Evo follows the evolution of life. Chemistry Element Periodic Table includes with details and graphics of all elements. Unit Conversion is a program that allows you to choose all types of unit (ie length, time, weight, speed etc) and then do conversions and comparisons between them. plus more! German Language Tutor, Speak and spell tutor, Study AidCards, Hermes Formula, Cloud, the weather, GEO Time, Gravity Simulator, FUNC2D, Gravity Well, Air Foil, Wave Maker and others. £12.50!

AMP6 - UNDER 10's EDISOFT PACK 1. This special 5 disk pack includes COLOURING BOOK, ANGEL'S MATHS is an educational game to help the children with their maths. THINGAMAJIG do your children like jigsaws? CLICK CLOCK to help children learn the time. FUNTIMES TABLES for maths. LET'S GO SHOPPING teaches simple maths. THE WORD FACTORY is an educational program to help children learn to spell. A very well presented program. 1MB. £17.50.

AMP12 - UNDER 10'S EDISOFT PACK 2 another excellent 5 disk pack includes CLASSROOM MATHS different scenarios a classroom, a rocket lift off, Fireman rescue and footballer scoring goals to teach maths. BIG TOP FUN a program to help children with words and pictures. ROCKET MATHS the game is in 4 parts The Take Off, The Star Map, The Rock Storm and The Landing. FUN TIME 1 crammed with delightful tuition on shapes, keyboard, clock and pictures. Prehistoric Fun Pack a must for young dinosaur lovers! includes 4 educational games. Dinosaur, Dinosaur, Snakes + Caves and Egginct. 1MB. £16.50

PD661 - STORYLAND 2 an adventure game for children upto the age of 8. The whole adventure is screen based with the child clicking on objects on the screen.

VIDEO

AMP14 - VIDEO TITLING EFFECTS PACK. This mega pack is only available from Public Dominator and is packed with programs that can be used to create quality title screens for your own videos. The pack includes SMOVIE, VIDEO DATABASE, SLATE, RTAP, PEEL, QUICK FLIX, CyroUtils, IMAGE LAB, SHOW FONT, TITLE GEN, VIDEO TOOLS on TAP, LACE, TIMECALC, BARNSTONE, STILL STORE, SHO MAKE ANIM, THE INTRODUCER, DISSOLVE, STARTLE, STARS, SUPERVIEW, BIG-VIEW, VIDEO PATTERN GENERATOR, SPORTS TEXT. A special 4 disk pack for £10.00! 1MB RAM required.

AMP13 - VIDEO CLIP ART PACK contains dozens of excellent full colour images for use in any package and of particular interest to those wanting excellent video graphics! Includes back drops and frames for creating quality titles. A special 3 disk pack for only £8.50!

We recommend the following font packs for use with the above Video utility and graphic packs.

FONTS

The following are MULTI coloured font packs

PSFF1 - 51 font styles £15.00

PSFF2 - 63 font styles £15.00

PSFF3 - 43 font styles £15.00

PSFF4 - 64 font styles £15.00

The following are SINGLE coloured font packs

PSFFA - 68 font styles £15.00

PSFFB - 66 font styles £15.00

PD53/56 - 50 font styles £10.00

Lots of the above fonts come in different sizes giving you more fonts than indicated.

MUSIC

PD458 - STAR TREKKER v1.3 - 8 channels, MIDI, standard tracker interface sound tracker compatible, FM and AM sounds and more.

PD553 - SOUND TRACKER V4.0 the latest version of the original Amiga PD music program.

PD299 - MED V3.00 is a music creator much like Sound Tracker with more features.

PD281 - OKTALYSER V1.1 the music composer.

PD285 - GAME MUSIC CREATOR allows you to create music in the normal way but then save for use in your programs. Supports MIDI!

AMP11 - SONIX scores 5 disks full. £12.50!

AMP23 - SOUND TRACKER modules 5 disks full. £12.50!

LICENSEWARE

The codes PSL, PSFF and DV used in this advert are Licenseware there is no more to pay. Public Dominator pays the author direct for you. No discount for multiple buys can be given, the disks are sold at the price indicated.

CATALOGUES

A concise printed catalogue is supplied with each order or is FREE if you send us a stamped S.A.E. A disk based catalogue showing full details of all our products costs only £1.00 or is FREE if requested with any purchase of £10.00 or over!

CLIP ART

The following 7 ClipIt! packs are all Black and White clip art spot illustrations suitable for any program with graphic capabilities. Each pack contains 5 disks. Pack 7 contains 3 disks.

CLAI - Sports, flags, animals, Borders, Halloween, hands, zodiac etc. £12.50.

CLIA2 - Men, women, A to Z, arrows, explosions, cartoons, pointing hands. £12.50.

CLIA3 - Fruit, herbs, meat, arrows, special occasions, vegetables, kitchen utensils, cups and glasses, art deco and breakfasts. £12.50.

CLIA4 - More Art Deco, Babies, Boys and Girls, humorous, A to Z, scrolls, calligraphic ornaments. £12.50.

CLIA5 - Christmas from both the 19th and 20th century from father christmas to barbals, to christmas trees and borders. £12.50.

CLIA6 - Mythological Creatures and Monsters, an excellent pack of creatures from all over the world. £12.50.

CLIA7 - Flower Power pictures of the most popular flowers, arrangements, borders. £8.50.

SPECIAL OFFER! On ClipIt! Volumes

Vols 1 to 4 - £45.00

Vols 5 to 7 - £30.00

Vols 1 to 7 - £70.00

CIP - A printed catalogue of all the images in volumes 1 to 7 - £10.00 or £3.50 if purchased with any of the above volumes.



Special Offer! The entire Fred Fish collection disks 1 to 630 for £409.50! This price, only 65p per disk!, is fully inclusive - the floppy disks, labels, VAT & delivery! (Overseas add £75.00)

PD & Shareware Prices

Disk codes without a cost are priced equally depending on how many you buy

1 to 5 disks are £3.00 each

6 to 10 disks are £2.75 each

11 to 50 disks are £2.50 each.

All prices are fully inclusive.
All overseas orders MUST add £275 to total.

Computer Supplies - Blank Disks etc.

Blank disks with labels:

10-£6.00, 25-£13.75, 50-£25.00, 100-£45.00, 200-£88.00.

Disk boxes: 10 cap. £1.00, 40/50 cap. £6.50, 80/100 cap. £9.00.

Disks and box: 10-£6.50, 50- £29.50 and 100-£53.

Disk labels: 100-£3.00. **Cleaning kit:** £3.00. **Mouse mat:** £3.00.

It's always the same, isn't it? A shelf-full of games, all vying for the pounds in your pocket. So make it easy on yourself, by using the guide we call...

The Magical History Scores

THIS MONTH'S SCORES

As always, after the holidays there's a glut of new titles—some good, some bad. It's like a mini-Christmas all over again—but without the pressies, darn it.



There's no hiding behind the camouflage this issue. *Pacific Islands* has come out tops. So if you want to get tanked-up turn to Page 50.

Pacific Islands	Empire	FG93%
Eye of the Beholder II	US Gold	FG91%
Apidya	Blue Byte	FG90%
Might and Magic 3	US Gold	82%
Deliverance	21st Century Entertainment	80%
The Manager	US Gold/Software 200	79%
Special Forces	MicroProse	79%
The Addams Family	Ocean	78%
Alcatraz	Infogrames	76%
Project X	Team 17	75%
Castles	Electronic Arts	72%
Ork	Psygnosis	72%
Super Ski 2	Microids	70%
Rugby World Cup—5 Nations	Audiogenic	69%
Vengeance of Excalibur	Virgin	64%
Samurai—The Way of the Warrior	Impressions	65%
HeroQuest Data Disk	Gremlin	60%
Agony	Psygnosis	60%
Leisure Suit Larry 1 (Remake)	Sierra	53%
Pools of Darkness	US Gold	53%
Space Quest 4	Sierra	48%

LAST MONTH'S SCORES

OK, so which software houses were sitting on their releases until just before the Easter hols? Tsk! No wonder there was only one Format Gold back then.

Vroom	UBISoft	FG91%
Dynablast/Bomberman	UBISoft	87%
Space Crusade	Gremlin	82%
Titus the Fox	Titus	81%
Elvira 2—The Jaws of Cerberus	Accolade	81%
Black Crypt	Electronic Arts	78%
Harpoon Battleset 3	Electronic Arts	75%
Brides of Dracula	Gonzo Games	73%
Backgammon Royale	Oxford Softworks	67%
Ultima VI	Origin/Mindscape	67%
Chess Champion	Oxford Softworks	65%
Go!	Oxford Softworks	64%
Space Gun	Ocean	57%
Fireteam 2200	Internecline	55%
Gateway to the Savage Frontier	US Gold	45%
Race Drivin'	Domark	45%
Psyborg	Loriciel	36%
The Jetsons	Hi Tec	29%

ISSUE 33'S SCORES

Three months on and some of these still look red-hot. Catch 'em before they all get lost in the scrimmage.

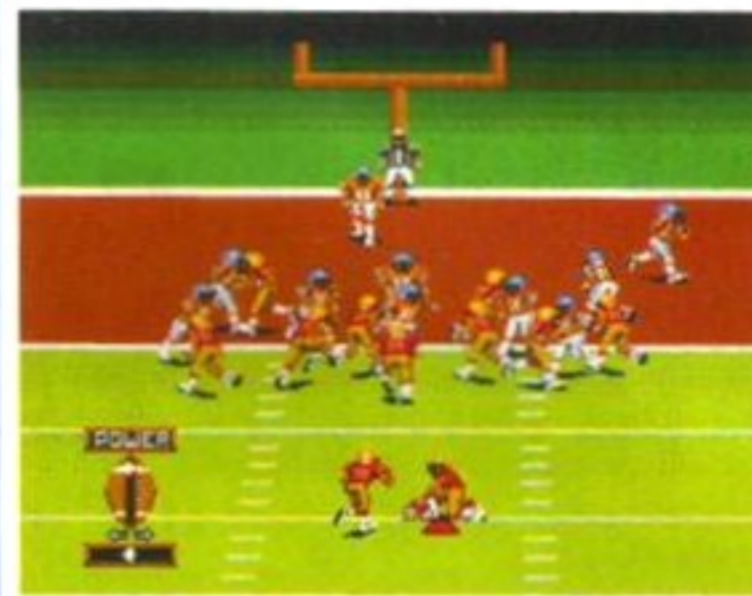

Rumour has it that John Madden American Football is well set to steal the top slot in next month's Gallup chart. How do we know this? Well, it's amazing what you can do with (a) an inside source and (b) a few free beers. Tongues begin to wag y'know.

John Madden's Football	Electronic Arts	FG94%
Shadowlands	Domark	FG93%
Storm Master	Silmarils	FG90%
Return of Medusa	Starbyte	85%
Pinball Dreams	21st Century	84%
Harlequin	Gremlin	78%
Wayne Gretzky Hockey 2	Bethesda/US Gold	78%
WolfChild	Core Design	76%
PGA Tournament Courses	Electronic Arts	72%
Mad Dog Williams	Game Crafters	72%
Crime City	IF	70%
Starbyte Super Soccer	Starbyte	63%
Video Kid	Gremlin	60%
Big Run	Storm	58%
4D Sports Driving	Mindscape	33%
Leisure Suit Larry 5	Sierra	50%
Willy Beamish	Sierra	44%
Great Napoleonic Battles	Impressions	40%
Borobodur	Thalamus	35%
Hare Raising Havoc	Infogrames/Disney	25%

LAST YEAR'S SCORES

Last year saw a few real belters riding high in the charts but sadly few of them are available as budget titles yet.

Secret of Monkey Island	Lucasfilm	FG92%
Cybercon 3	US Gold	FG90%
Gods	Renegade	FG90%
Hill Street Blues	Krisalis	82%
Jahangir Khan's Squash	Krisalis	81%
Predator 2	ImageWorks	81%
The Killing Cloud	ImageWorks	80%
Das Boot	Mindscape	79%
International Ice Hockey	Impulze	79%
The Famous Five	Enigma Variations	73%
Chuck Yeager's AFT	Electronic Arts	71%
Action Stations	Internecline	70%
Alpha Waves	Infogrames	70%
Tetris	Infogrames	70%
Viz	Virgin	70%
The Bard's Tale 3	Electronic Arts	69%
Exile	Audiogenic	68%
Merchant Colony	Impressions	67%
Aces of the Great War	Mindscape	65%
Quadrel	Loriciel	63%
Metal Masters	Infogrames	52%

TOP TEN AMIGA BUDGET-PRICE CHART

1(2)	First Division Manager Code Masters £7.99
2(6)	Rainbow Islands Hit Squad £7.99
3(1)	F16 Combat Pilot Action Sixteen £9.99
4(4)	Scooby & Scrappy Doo Hi Tec Software £7.99
5(3)	James Pond GBH £7.99
6(-)	Lotus Turbo Challenge GBH £7.99
7(10)	World Cricket Zeppelin £7.99
8(5)	Toyota Celica Rally GBH £7.99
9(9)	Wacky Races Hi Tec Software £7.99
10(-)	Operation Thunderbolt Hit Squad £7.99

LAST YEAR'S TOP TEN FULL-PRICE CHART

1	Gods Renegade/Mindscape
2	Lemmings Psygnosis
3	PGA Tour Golf Electronic Arts
4	Speedball 2 Mirrorsoft
5	Power Up Ocean
6	S.W.I.V. Storm
7	Viz Virgin
8	Final Whistle Anco
9	'Nam Domark
10	Super Monaco GP US Gold

THE TOP 30 AMIGA FULL PRICE CHART

1 (-)	New Project X Team 17 £25.99 75%
2(1)	Formula One Grand Prix Microprose £34.99 FG92%
3(-)	New Space Crusade Gremlin Graphics £25.99 82%
4(-)	New Black Crypt Electronic Arts £25.99 78%
5(-)	New Special Forces MicroProse £34.99 79%
6(-)	New Shadowlands Domark £29.99 93%
7(-)	New Pinball Dreams 21st Century Entertainment £25.99 84%
8(2)	A320 Airbus Thalion £35.99 78%
9(4)	WWF Wrestlemania Ocean £25.99 72%
10(-)	Re James Pond 2—Robocod Millennium £25.99 FG91%
11(3)	Jimmy White's Whirlwind Snooker Virgin £29.99 FG91%
12(-)	New John Madden American Football Electronic Arts £29.99 FG94%
13(-)	New Award Winners Empire £25.99 Comp
14(6)	Birds of Prey Electronic Arts £34.99 88%
15(9)	Populous 2 Electronic Arts £29.99 FG95%
16(-)	New Titus the Fox Titus £25.99 81%
17(-)	New Agony Psygnosis £25.99 60%
18(18)	PGA Tour+ Electronic Arts £29.99 Comp
19(26)	Heimdall Core Design £34.99 88%
20(5)	Harlequin Gremlin Graphics £25.99 78%
21(11)	Ultima 6 Mindscape £30.99 67%
22(14)	Castles Electronic Arts £29.99 72%
23(12)	Another World US Gold £25.99 80%
24(-)	New Indy Heat Storm £25.99 Next Issue
25(8)	Dizzy Collection Code Masters £24.99 Comp
26(20)	Monkey Island US Gold £29.99 FG92%
27(17)	Football Crazy Challenge Anco £25.99 Comp
28(19)	Alien Breed Team 17 £24.99 74%
29(10)	World Series Cricket Soundware International £29.99 Next Issue
30(16)	Oh No! More Lemmings Psygnosis £19.99 82%

Chart Chatter



You can't go wrong with a tried-and tested formula.; scrolly shoot-em-ups...

While the once-tranquil inhabitants of the charts look on in terror, you can hear the massed cries of "It's beating everything in its path!" The product of the deranged imagination of Team 17's mad scientists, *Project X* stomped its way out of the laboratory and into the shops. No-one could have expected it; no-one prepared for it—but it happened all the same. Striding over the top 10 like a massive insectoid mega-being, it dealt death-blows to virtually all of the long-standing titles which had been quietly unaware of its existence.

First to cop it was *Formula One Grand Prix*. As the creature (known to its creators as The Creature) marched across Monaco on its way to a small villa by the Mediterranean, drivers swerved wildly to avoid it – with disastrous results. It'll take the marshalls at least a month to dredge all the cars from the harbour.

Chasing after the creature is a chapter of



...another Formula that the punters love to bits; an excellent drive-em-up.

deadly-looking Space Marines fresh from their latest *Space Crusade* -but we don't give much for their chances. More luck might be had by the denizens of the *Black Crypt* – an assortment of evil creatures almost as nasty as our insect enemy.

MicroProse have sent their hardest troops, the *Special Forces*, in to help the assault. The four lunatic hard-nuts join forces with four adventurous chaps from the *Shadowlands*. They may all be armed to the teeth—but *Project X*'s teeth are bigger than their arms!

Meanwhile, in a different part of Southern France, another *A320 Airbus* crash-dives into a hill in a desperate bid to miss the creatures deadly attack. Sadly, the passengers on board were the men (pah!) from *WWF Wrestlemania*. And dangling from the undercarriage was *James Pond 2 – Robocod*, looking like a fish out of water. Is there no hope now?



"Straight in at number three, the Crusade that's just Space-tastic..."



...but hot on its heels at number four, a deep personal (two-headed) friend of mine."



MAIL ORDER DIRECT LTD
61 Gainsborough Rd, Finchley, London, N12 8AA

NEW !!!
AMIGA 600 & 600HD
P.O.A.!

VISIT OUR SHOPS!

Power Station Computers, 14 Station Road, Finchley, London N3 2RY
It's right by Finchley Central Tube Station so now you can try our products before buying! - our trained and friendly staff will be pleased to demonstrate any product
299-301 High Street, Sutton, Surrey
TEL: 081 643 7078
IMPORTANT ALL machines are tested prior to shipping

AXE POWER PACK 1 Its your CHOICE! You CHOOSE your own chart hit

A CARTOON CLASSICS
A500 PLUS (1Mb built-in) **PRICE SMASH!**
Including 1Mb disk drive, TV modulator, 4096 colours, multi-tasking, speech synthesis, 4 channel stereo, mouse, 2 operation manuals, Workbench 2.04, tutorial disk, all cables, built-in battery, real time clock.
PLUS
The Simpsons
Captain Planet
Lemmings
Deluxe Paint III

PACK 1A with 2Mb Plus FREE GFA Basic 3.5 £375
MEGA PACKS

B Pack A PLUS the following:
Good quality joystick
Dust cover
Mouse mat
The following games (all tested to work on the A500 Plus) Rick Dangerous II, Test Drive II, Gazza II, Gunship, Days of Thunder AND Interword, a great wordprocessor worth over £49

C Pack B with chart game of your choice (up to £26) e.g. PGA Tour Golf, F19, R-Type 2, F15 etc.

AXE POWER PRICE only £319
AXE POWER PRICE only £366
AXE POWER PRICE only £379

Total package worth over £600.00

NEW PRICE SCOOP! MONITOR POWER NEW PRICE

AXE SCOOP! NEW from GOLDSTAR TV MONITOR
inc. Amiga lead
POWER PRICE of only £174.99 inc. VAT!!

PHILIPS 8833 MK11 UK VERSION
Including **FREE** lead plus **FREE** dust cover plus **FREE** F19 Stealth Fighter plus **FREE** 1 year on-site maintenance
AXE Scoop! POWER PRICE only £219.99 inc. VAT

A500 HARD DRIVE PROMOTION POWER
GVP Series II 120Mb hard drive (takes up to 8Mb)
AXE POWER PRICE only £459 inc. VAT
GVP SER II 52MB (TAKES 8MB RAM) £359

AXE POWER PACK 2 HOME STARTER POWER - It's all you will need!

Amiga 500 Plus + joystick + dust cover + mouse mat + 10 disks + 40 cap lockable storage box + the AXE pack of FIVE GREAT GAMES + word processor + second drive + Philips 8833 MkII monitor + dust cover + all leads + F19 Stealth Fighter + 1 year on-site maintenance (monitor) + the AXE SUPER COMPUTER TABLE (RRP £79.99) featuring extended shelf for keyboard + second shelf for printer - makes your Amiga into a REAL workstation + 3 courier workstation.
RRP over £1029
AXE POWER PRICE £699 + Swift 9 colour printer inc. Printer Pack **£899**

NEW PRODUCTS PRINTER POWER NEW PRICES

All dot matrix printers come with a **FREE** printer pack containing 200 sheets of cont. A4 paper - 5 cont. envelopes - 100 cont. address labels - Amiga cable - dust cover - 1 printer driver
All Citizen printers carry a full **2 YEAR WARRANTY**

- Citizen 120D 9 pin, 120 cps, NLQ, 80 col £149.99
- Citizen 124D - 24 Pin Mono £209.99
- Citizen SW9 Colour £220.00
- Citizen SW24E Colour (NEW) £289.99
- 6LQ Fonts, 180 cps DR
- Star LC24/200 Colour £289.99
- Hewlett Packard Deskjet 500 £359.99
- Hewlett Packard Deskjet 500 colour £559.99

AXE POWER PACK 3 ITS GOT THE POWER

From £549.99 with software

AMIGA 1500 COMPUTER PACK WORKBENCH 2.04

NEW 1500 BRAND NEW 1500Pack that's ideal for both home and business!!!
Central Processing Unit (CPU)....
1mb. RAM, 2, 3.5" Floppy Disk Drives. Sight expansion slots to take all Amiga 2000 peripherals.
Keyboard and Mouse
Plug-in keyboard with Numeric key pad. 4 cursor keys. 2 button Amiga Mouse.

PLATINUM WORKS HOME ACCOUNTS DELUXE PAINT III ELF - MAGIC GAME TOKI - ANIMATED FUN AMIGA GUIDE BOOK

without monitor £549.99
with Philips 8833 Mk II £789.99
with Commodore 1084S £799.99
KCS IBM adaptor £279

52Mb Quantum GVP Controller Card £289.99
120Mb Quantum GVP Controller Card £440.00

THE ULTIMATE PACK AXE POWER PRICE INC. VAT

PERIPHERAL POWER

- 0.5Mb with clock only £29.99
- 2000 sheets fanfold quality paper £15.00
- G.F.A. Basic £9.99
- Workstation - aluminium - space for drive £39.99
- T.V. Tuner for Philips 8833 MkII £49.99
- ZY-FI stereo speakers £38.95
- Unbranded disks 40 plus 40 cap lockable storage box £24.99
- KCS Board £219.99
- Trackball - the ultimate feel £29.95
- Rendale Genlock 8802 with **FREE** switch box £184.99
- Replacement power supply £39.99
- Quickjoy TOPSTAR (for professionals) - microswitches, autofire £21.99
- Zipstick triple-fire - strongest on market £14.99
- Konix Speedking - brilliant - autofire - The Best £12.99
- Dust cover for 1500. Covers monitor, CPU & keyboard £14.99
- Tilt 'n' Swivel monitor stand with position locking £17.99

UNBEATABLE PRICES SALE POWER PRICE SMASH!

	RRP	Sale price		RRP	Sale price
External drive	£59.99	£49.99	Power 880b drive	£89.99	£69.99
Power 880E drive	£69.99	£59.99	Dual drive	£139.99	£119.99
1Mb to 500+	£69.99	£49.99			

Authorised dealers for Commodore, Atari, Amstrad, Citizen, Star, Panasonic, Supra, Sega, Hewlett Packard

ORDERING POWER It's so easy!
24 HOUR SALES POWER HOTLINES

VISA AMERICAN EXPRESS 081 343 0419 (6 lines) Access

HOW TO ORDER

- By phone 081 343 0419
- By fax It's fast 081 643 5414
- By post: make cheques, bankers drafts, postal orders or building society cheques payable to AXE Direct Ltd. Allow 5 working days for personal cheque clearance.

DELIVERY: UK MAINLAND ONLY. THE AXE POWER SERVICE

Next day delivery only £10.00 inc. VAT
3-5 day only £7.50
P&P under £100.00 only £2.50
P&P over £100.00 only £4.00

MAIL ORDER PRICES ONLY - SHOP PRICES MAY VARY

Please have your credit card ready when ordering for easy reference. Thank you

OPENING HOURS:
Mon-Fri: 9.00am - 6.30pm
Saturday: 9.00am - 6.00pm
Sunday: (shop) open 10.00am-1.00pm

E.& O.E. Prices are correct at time of going to press, and include VAT but subject to change, as we are sometimes let down by suppliers. Call AXE first.

AXE DIRECT LTD PRICE...POWER...PERFORMANCE

Name (Mr, Mrs, Ms) _____
Address _____
Postcode _____

Credit Card Please circle Card No. _____ / _____ / _____ / _____

Signature _____ Expiry date _____

PLEASE SEND ME	PRODUCT	PRICE	QUANTITY	POWER PRICE

All products are sourced from the UK - no grey imports - SO rest easy with your official UK warranties.

Carriage Total Power Price _____

ALL PRICES INCLUDE VAT

AMIGA Repairs

for your Amiga or C64 repairs, who better to turn to, than Commodore's Approved National Repair Centre.

For all repairs to your computer, one low payment covers diagnosis, repair (including parts and labour) and delivery back to you.

SPECIAL BONUS

FREE SOFTWARE!

If you send in your computer to Commodore's Approved National Repair Centre for repair, we will send you a piece of **FREE SOFTWARE!**

The experience and expertise of our technicians ensures that your computer is repaired to a high standard at a low cost. Most repairs will be carried out within 12 working days.

To schedule a repair and claim your **FREE SOFTWARE**, simply call Michelle or Julie on 0733 391234.

Be ready to quote your name, address, computer type, serial number, type of fault and code AFR 6/92.

The cost is for a C64, £47.50 and for an Amiga 500, £57.50. Payment can be made by cheque, postal order or credit card. Part refund will be made if the computer is found to be beyond economic repair.

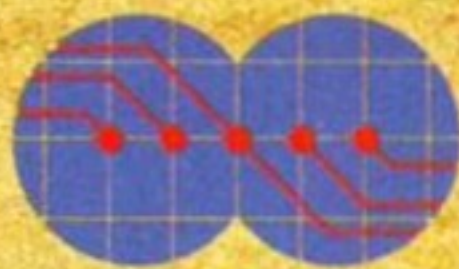

NRC
COMMODORE APPROVED
National Repair Centre

0733 391234

FMG House,
Newcombe Way, Orton Southgate,
Peterborough PE2 0SF



PaRTs & LaBOuR



FRee SoFTWaRe



SerVice



**ALL PARTS AND
LABOUR COVERED
IN ONE EASY PRICE**



THE LUCKY BEGGARS

The biggy £50 voucher goes to David McKone for sending in the best maps and player's guide I have received for *Cadaver!* Well done. Helping Hand is equally sparse on up-to-date entries, so the prize goes to Chris Hughes for his answer to the *Robin Hood* cheat plea. All you people who sent in solutions to the game—hold on! I may be printing one if enough people ask!

Gamebusters may be going through a few changes soon, so keep your eyes peeled and in the meantime, keep those tips, cheats, *Deluxe Paint* maps and solutions flooding in to:

GAMEBUSTERS

Amiga Format

30 Monmouth Street
Bath
BA1 2BW.

THE SIMPSONS

Yes! Yet another hint for the ever-popular conversion of *The Simpsons*!

If you've ever wondered what the whistle is for, then ponder no longer. Stand by the last window of the Springfield retirement home and blow the whistle. A man should appear throwing money, so grab as much as you can to spend in the shops.

Mick Heys
Accrington, Lancashire

ALIEN BREED

Although we were disappointed with this Aliens-inspired shoot-em-up, a lot of people have found the game interesting enough to come up with a few cheat codes.

A lot of the cheats are far too rude to print, but here are a couple that may make things a little easier.

Press the Caps Lock key, then type the following (one at a time)

I CANT BE ARD TO PLAY THE FIRST LEVELS** Skips to level 3 (fill in the asterisks).

ALIENS ARE FAGGOTS Makes aliens weaker.

IS IT TRUE THAT ALIENS SUPPORT MAN UTD Makes aliens very weak.

PUFFNUTS MODE Makes aliens move slowly.

BEWARE ALIENS SPADGE HAS DROPPED ONE Gets rid of all the aliens.



Keep those aliens at bay by using one of the amusing cheat codes.

Game Busters

Time for another cheat-packed trip into the gaming dungeon, but the ghouls, goblins and nasty little sticky things are ready to creep up your trouser-leg and give you the gaming willies! Never mind, here is **Maff Evans** and his 'busters to provide a torch, a solution and a set of cycle clips.



POPULOUS II

If the tips we printed in *Amiga Format* 33 weren't enough, then try this little cheat – if you're not one of the masses of people that sent it in, of course!

When the "Choose your Deity" screen appears, enter ADKIUCMCZNDIFINL to start the game with maximum power for all areas of godly control.



You can use these torrential effects at any time, without even having to build up your energy. Just use the cheat to have all the godly powers available to you straightaway.

WOLFCHILD

If you're having trouble battling through the gorgeously-painted levels on this Strider-style beat-em-up, then you may need a cheat. Well here is one we prepared earlier...

When the title screen appears, type in THE PERFECT KISS. You will now be able to start the game with infinite weapons. If this doesn't help, try typing ITS NOT ALL WALKING when playing the game and you will be able to restart on that level.

Graham York
Newcastle-upon-Tyne



Too many enemies for you? Not any more!

Cadaver

£50

What an atmospheric platform adventure this was, and it has managed to cause quite a stir recently. It seems that a lot of people want more help than the level one solution that was printed in the first Screenplay book, so here is the low-down on level two.

Preparation

Before starting this level, it pays to have your stamina topped up from the barrel on level one. It's also preferable to still have the fire-protection spell (so you'd better practice beating the dragon on level one without it). To beat level two, you should have these items:

- Wand – Freeze Spell
- Wand – Magic Missile
- Scroll – Dispel Trap
- Flask – Shot Shield
- Flask – Giant Jump
- Flask – Super Fast
- Flask – Stamina (if you haven't wasted it all that is)
- Flask – Cure Potion

Monsters

- Stone-Spitting Volcanoes – use a Shot Shield or Freeze Spell as a last resort.
- Poison Monsters – use a Cure potion to heal yourself.
- Floating Eyes – paralyse you, so look out when you're in a room with Volcanoes or Poison Monsters.
- Tortoises – can be hard to kill.
- Mouths and Eyes in Walls, Insects – can be dealt with fairly easily.

Solution

Follow the steps listed, finding your way around the rooms using the map. The objective of the level is to collect six transporters and a green gem to allow access to rooms 91 and 92.

Beginning at room one (the Hall) go to room two and pick up a flask of Shot Shield (in the chest), shiriken and the Wand of Massacre (in the strongbox). Drink a Shot Shield potion and hold the shiriken, then go to room three. Kill all the volcanoes, then go to room four. Put the ashes in the urn, pick it up, then move the altar and the drape by jumping underneath the skull. The Scroll of Mind Blast you find may come in useful, but it's not essential.

Go to room five, pick up the books and tome, then get the shiriken from the chest. To leave the room, pull the lever when the light turns black, then go to room six. Throw a book through the gap between the two walls to make the top sections disappear (if a book gets stuck, the gap will widen). Pull the lever and go to room seven, avoiding the walls which drain your stamina. Once in room seven, pull the lever, drop the tome and any books you still have, then go to room eight.

Jump underneath both skulls to remove the drape, then return to room three. Use the left-

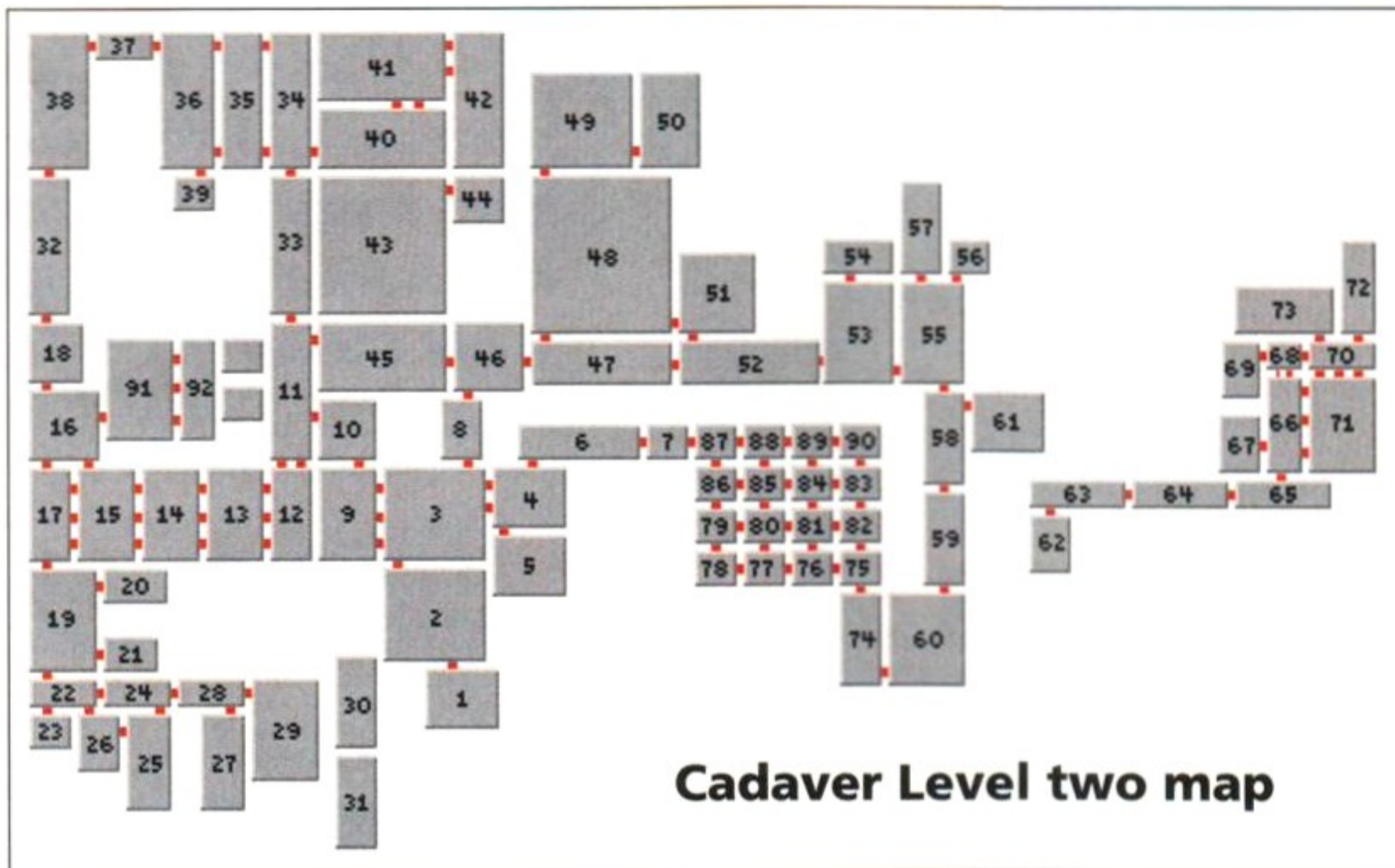

Cadaver Level two map

hand door to go to room nine, pick up the token and go back through the same door to room three. Pick up the teleporter to get to room 10 and pull the levers in the following order: 2, 1, 3, 2. Now press the button to light the wall blocking the door. Before entering room 13, use a Shot Shield potion and kill the volcanoes using shiriken and Magic Missiles. Go to room 14 and approach the token from the left. Pick it up and approach the Wand of Sleep from behind (down the central line) to pick it up.

Go to room 15 and press the button on the wall to remove the drape. Examine the chair and pull the lever on it to lift the other drape. Press the new button revealed on the wall to find a book about the lost passage (the two blank squares on the map). Go to room 16 to get the key chest, then go on to room 17. Pull the lever and go back via rooms 16 and 15 to get

Plates and switches like the ones on this screen may be just the thing to get you out of a difficult fix.



the chest, which contains a teleport and a pot of gold. If you keep opening and closing the chest you will find even more gold. Use the teleporter to get to room 18, then go on to room 19.

Pick up the Super Fast potion flask on the table in room 19, then go to room 20 to get the barrel of stamina potion. Go to room 21 and pick up the cure poison potion, but ignore the cleaver, since it is pretty useless. Go to room 22 and cast the sleep spell on the eye. Go to room 23 and jump on top of the pan before it starts to rise. This should allow access to the chest which contains the key to room 28. If you don't get to the pan in time, use the bed to gain a step onto the pan.

Go to room 25 and move the strongbox (which contains gold) underneath the trophy. Pull its lever to open the door to room 26. Go into the room, press the button to unlock the door to room 22 and pick up the teleporter to get to room 27. Push all the bottles off the ledge to get the key and the gold, then go on to room 28. Use the key from room 23 to unlock the door to room 29 and look under the highest ledge to find a key. Use this key to unlock the chain and pull it to move the block covering the hole. Drop down the hole to get to room 30 and use a sleep spell on the eye. Pull the lever to access the chain and drop down to room 31. Pick up both keys, pull the lever and jump on the chain to get back to room 30. At this point, you will more than likely be poi-

soned, so drink a cure poison potion. Walk onto the chain to get to room 29, then go back to room 22.

Having unlocked the door with the tortoise-shell key, go to room 32 and use the remaining key to move the bars. The plate below the scroll will close the other bars when the light isn't black, but you don't need to worry about that at this point. Pick up the token and go to room 33, using the sleep spell to close all three eyes. Next go to room 34, dropping off the teleporters and the urn off in room 16.

Pick up the token and place all four tokens collected into the slot to open the door to room 35. Go to room 35, pull the lever and then go on to room 36. Move under the ledge to make the monster push the strongbox down onto the floor. The box (containing a sack of gold) will now be trapped. Go to room 37 and use the massacre spell to kill the monster. Examine its shell to find a key, then go to room 38. Avoid standing on the plate underneath the button and open the chest to get the teleporter. This transports you to the circle in the middle of the room and is needed later.

Go to room 39, pull the lever to move the bars and pick up the shiriken and silver coin. Next, the bars will close and the mouth will drop some meat, gold and a poison potion. Throw the poison potion at the mouth to get the gold, then return to room 34 via the stairs in room 36. On the way, pick up the scroll of freeze and the strength potion from room 35 and once in room 34, pull the lever. Go back through room 35 to room 40 and pull the lever to lower the board. Push this over the pit, jump on it and pull the next lever before moving on to room 41. Pick up the key, go to room 42 and cast the sleep spell on the eyes before picking up the gems (the book will be the one you threw through the gap in room six).

Go back upstairs and go through room 43 into room 44. Pick up the gem and the scroll of unlock chest, which will only open two chests. You have a choice of boxes to open:

Chest – gold

Strongbox – bless potion wand

Casket – Stamina potion

Return to room 43, drink the strength potion and pull the pillar to the ledge containing the sack of gold, the Stamina potion and a key to the door in room 33. The items can be brought within your reach by pushing the pillar against the ledge, forcing the item either onto the pillar or onto the floor (if it lands on the pillar, push the pillar under the wooden board to knock the item off). Go to room 11 and insert the gems in the order asked to open the bars to room 45. Go to room 45, where there are three sets of spikes. These only appear when you get close to them, so time your jumps carefully (only the last set are permanent).

The eye in room 46 won't let you pass if you pick up the key, so push it through the bars and pick it up when you get past. Go to room 50 and pick up the spike. Pull the back to reveal a keyhole, then insert a key to bring



Watch out for the skulls on the walls. They are useful in certain locations, but others pack a nasty (sharp) punch!

down a chain. The strongbox contains gold which closes the exit when collected, so pull the chain to reopen it. Return to room 49 and press the button to open a hole in the wall. Place the spike in the hole to open a door to room 51 and open the chest to get a gauntlet.

Return to room 48 and place the bucket under the red and brown drape. Jump onto the drape-covered bucket to reveal a button and press it to reveal a chest containing a chicken leg and some gold. Go to room 51 and feed the mouth some meat and chicken to open the exit to room 52. Go to room 47 and pick up the teleporter to get behind the bars in room 52. Unlock the bars and the door with the key from room 46, then go to room 54. You don't really need the food, so throw the flask of poison (on the floor) at the mouth to get the gold, then escape.

Return to room 53 and pull the lever. Drop a shield beside the gem and push it away from the lever until the gem hits the wall. Pick up the gem, watching out for the walls which will now close in on each other. Go to room 55 and move the board over the pit below the button. Pull the lever five times and jump onto the board from the higher stairs. Push the button and drink the fire shield potion before going on to room 56. Pick up the gem and move on to room 57. Push the second bar from the right towards the lever and move straight in to the room before the bar drains your stamina. Pick up the sack of gold and the map spell, then pull the lever and leave by simply touching the second bar from the left (but not the same one as before).

Go to room 59, where a floating eye will be waiting there. Immediately step to the left so that you are not in line with the stairs and when the paralysis wears off, move up the left-hand side until the stones from the door have gone

Chests may contain useful items, but you'd better watch out! They may well cause something extremely nasty to happen to you!



past. Now go to room 60 and press the button to get the trolley system moving. Pick up the gem and the scroll of unlock door and jump back onto the trolley once it has past the bars. Go to room 61, moving right in room 59 to avoid the stones.

Place the gems in the slot in the order asked to move the altar from over the steps. Go to room 63, watching out for the insects that are on the stair in room 62 (so get off the steps as soon as possible). Once in room 63, press the button to get across the pit and into room 64, then return to room 63 for the key to the lock. Go to room 67, hold the gauntlet and open the strongbox to get the shiriken and the sack of gold. Go to room 69, where you will find three bags of gold and a lead-lined casket. Place the bags in the casket one by one and open the casket in room 70 to transport them. When you have collected all three bags, go on to room 71.

The key in this room is a bit tricky to get hold of, so you will need to use a spell. If you don't have a shot shield spell or freeze spell left, then use a super fast potion. The volcanoes can be killed off, but it is dangerous to stay in the room if the eye has paralysed you more than once. Now unlock the door in room 70 and go to room 72.

Open the chest to get the two keys. Drop the sacks of gold from the teleport-casket onto the steps between the skulls and press the buttons on them to activate the teleporters. Push both teleporters off the altar – one will break while the other should teleport you to room 61. Go back to room 60 and on your way around on the trolley, press the other button to lift the drape. Get off the trolley before you are pushed off by the bars and go to room 74. Use the scroll of unlock door and go to room 87 using this route: 75, 82, 83, 84, 85, 86, 87. Unlock the door and pull the lever to get a sack of gold. Go through rooms 86, 85, 80 and 77 to get to room 78.

Along the route you will come across a volcano which can be removed fairly easily – as long as you don't touch it! In room 78, pull the lever to get a stamina potion and go back to room seven to pick up a large gem.

Make your way back to room 16 (using the right door in room three to get quickly through room 10) and pick up the urn and the teleporters (you should now have six teleporters). Any magical items you have are confiscated as soon as you enter room 91, so drink any Stamina potion you have left. In room 91, drop the urn on the empty shelf and place the gem you picked up in room seven on the empty shelf. Drop the teleporters down the hole in the centre of the room, make your way to room 92 and pull the lever until the light is black. Now all you have to do is wait on the circle to get to level three.

That's all we've got space for this month, but rest assured further level solutions will be printed soon.

**David McKone,
Chester-Le-Street, County Durham**

Knightmare—Part 2

Hope we didn't leave any players of Tony Crowther's latest role-playing adventure in the lurch too much when we left off the *Knightmare* tips last month! To get you a little further, here is the second installment of our tips, outlining the three levels of the Sword Quest. The fourth quest is pretty tricky, so we'll be printing the solution to that on its own at a later date (when Alan sends us the final tips - hint, hint).

**Alan Holwill,
Stuttgart, Germany**

AMIGA FORMAT

104

JUNE 1992

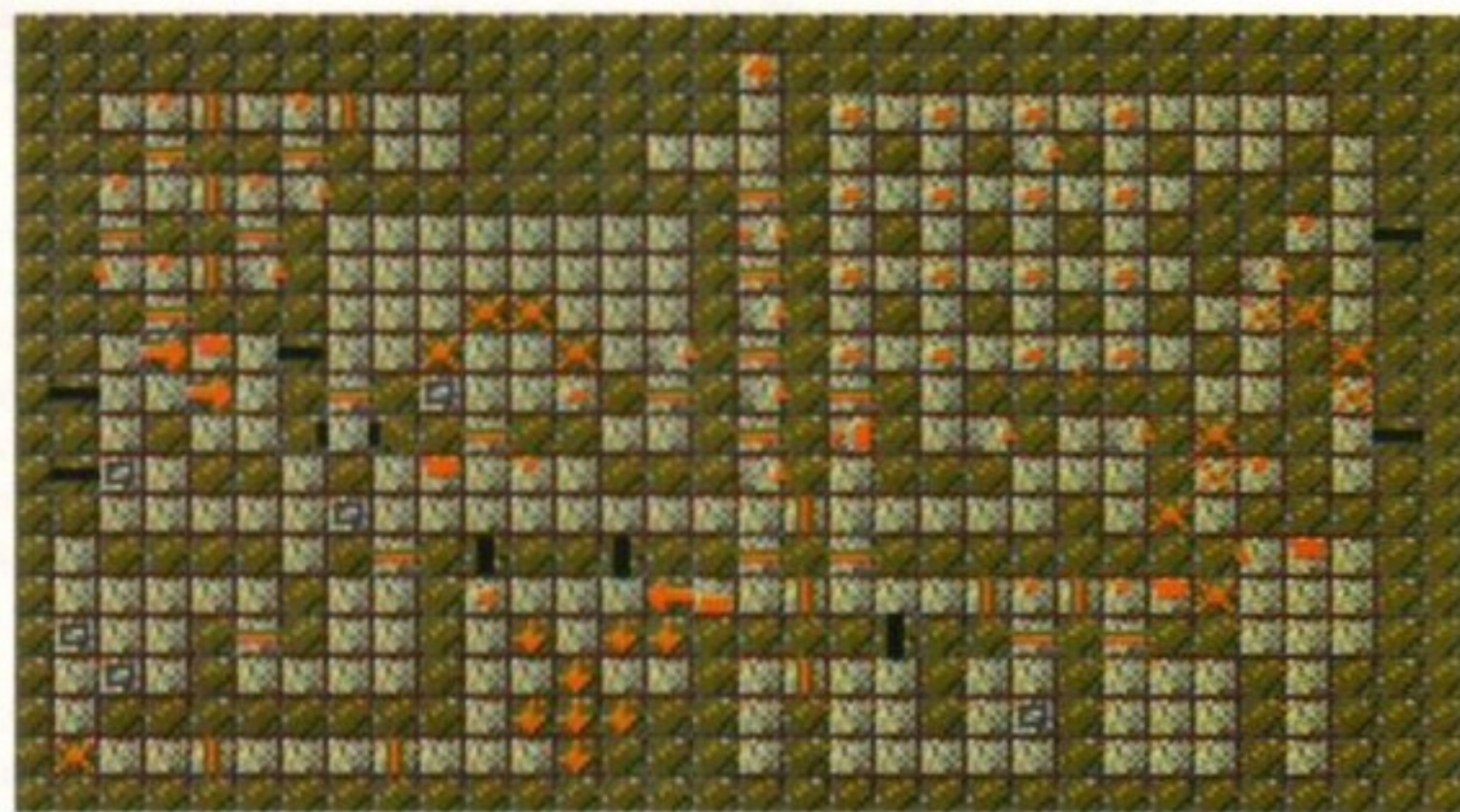

THE SWORD—LEVEL 1

Items

Leather Trousers, Trousers, Leather Jacket, Boots, Denim Jacket, Sandals, Vest, Helmet, Wand of Magic, Sheath, Fencer, Shield, Penknife, Big Bow, Cross of Life, two Gold Keys, three Bronze Keys, four Iron Keys, Grapes, three Apples, three Boiled Eggs, two Rock Cakes.

Messages

1. Hit the button when ready for Hell.
2. The Game Rooms.
3. Only push the right ones.
4. The Monster Raid.
5. Beware the Guardians
6. You make the fire, can you stop it?
7. The word is secret.
8. Get 'em out and face them.

THE SWORD—LEVEL 2

Items

Staff of Aura, Wand of Pain, three Arrows, Funny Stick, Heal Stone, Fencer, Bronze Key, Gem Key, two Gold Keys, Rock Cake, Egg, Three Apples, three Grapes.

Messages

1. When is a wall not a wall?
2. Run away....
3. The sounds of Hell.
4. Lots of work.
5. Bread trails are handy.
6. Beware the trap.
7. Remember to hide.
8. Hunt for gold.

SOLUTION TO THE MAZE

Open the door to the Maze Area and enter the portal directly ahead of you. Now go west, south, east, west and north. Get the Iron Key, then go east then south. Unlock the door, go south and get the Rusty Key. Now find your way out (which shouldn't be too hard).

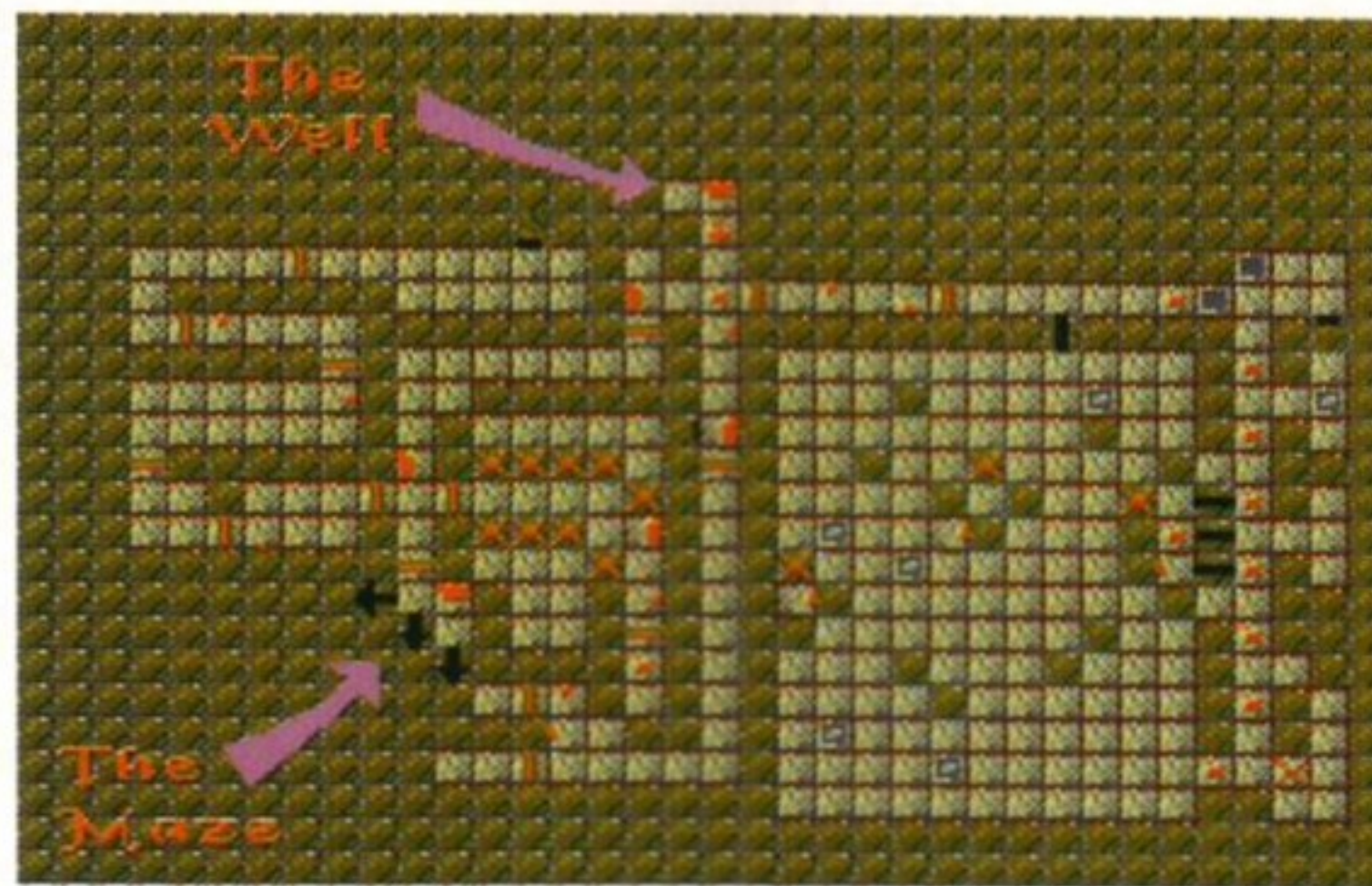

THE SWORD—LEVEL 3

Items

Shield, Crash Helmet, Broad Sword, Chain-mail Trousers, three Throwing Stars, Staff of Mystic, four Balls, Racket, Chest, Sword of Freedom, Bronze Key, Gem key, 28 Apples, two Milk Bottles, Grapes, two Spider's Legs.

Messages

1. Welcome to the Dungeon.

Well that's it for the second set of tips. The last level's mysteries will be unravelled soon, so keep watching this space!



COULD YOU WIN ONE OF HISTORY'S GREAT SEA BATTLES?

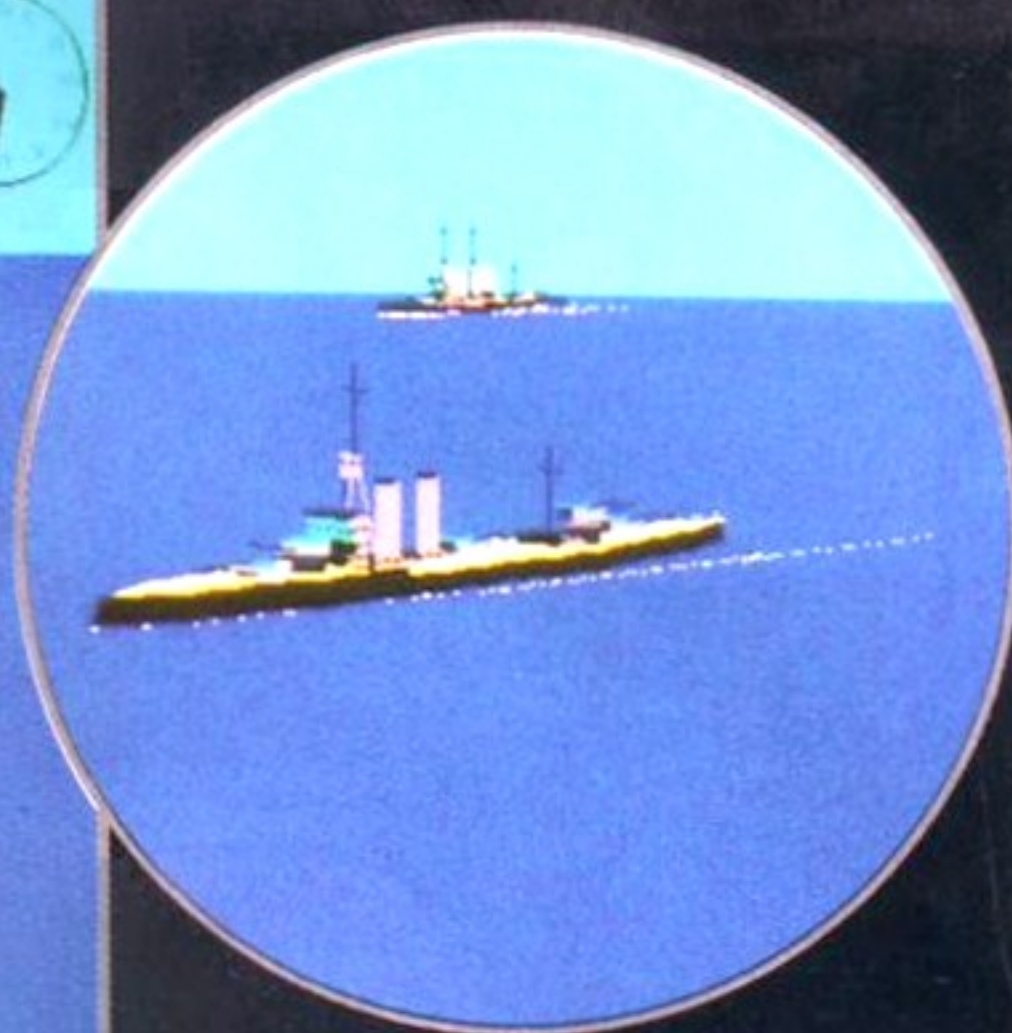
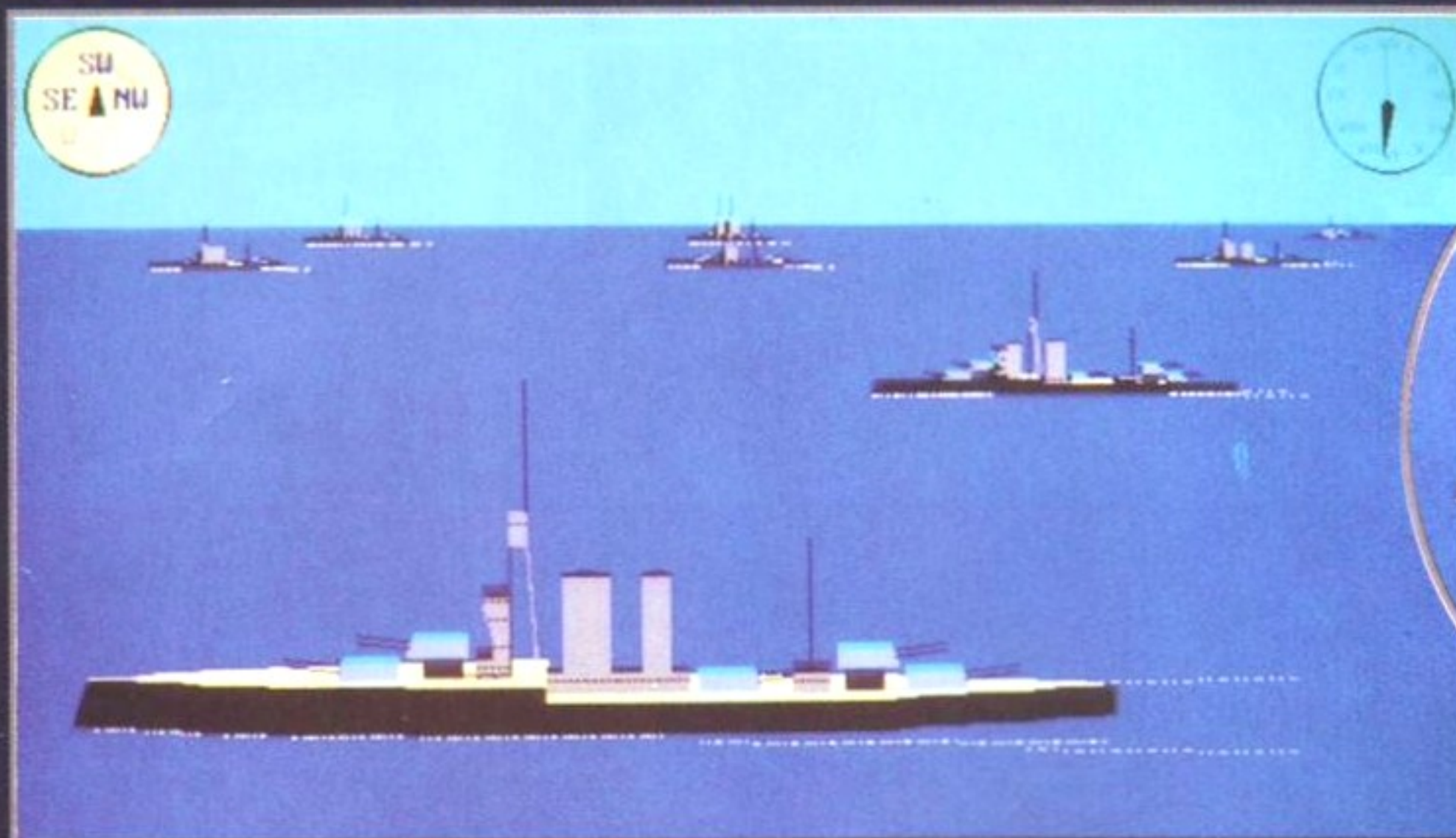

The screen shots show British battleships steaming towards the German High Seas fleet, at the Battle of Jutland.

DREADNOUGHTS is a computer simulation. It recaptures the drama and spectacle of history's great naval battles – from the Ironclads of the 1890s to the sinking of the Bismarck.

The DREADNOUGHTS program includes the battles of Coronel (1914), Falklands (1914), Dogger Bank (1915) and Jutland (1916). These battles have been meticulously researched, are displayed in full 3D and are complete with shattering sound effects. All the player has to do is take the role of Admiral...

DREADNOUGHTS is available for the IBM PC and compatibles, Commodore Amiga, Atari ST, and Acorn Archimedes. Price £34.95 (inc. VAT & postage).

Optional Scenario Disks require the Dreadnoughts program:

Ironclads Scenario disk:

The Battle of Yalu 1894
The Battle of the Yellow Sea 1904
The Battle of Ulsan 1905
The Battle of Tsushima 1905
Price £16.95

Bismarck Scenario disk:

The Battle of the River Plate 1939
The Battles with the Bismarck 1942
The Battle of Java Sea 1942
The Battle of North Cape 1943
Price £16.95

Please send cheque/PO to: **Turcan Research Systems Ltd,**
83 Greencroft Gardens, London NW6 3LJ – or telephone an
order using your credit card to:

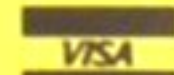

071 625 8455

(Orders are despatched within 48 hours)



Programmer: **Dr Peter Turcan** – the author of *Waterloo* and *Borodino*

WIN THIS AMIGA 500+ AND A PHILIPS 8833 COLOUR STEREO MONITOR



PLUS

- Cartoon Classics • Lemmings • Captain Planet •
- Bart Simpson • Paint III - with animation • Workbench 2 •

PLUS

- Hollywood Collection • Robocop • Batman - The Movie •
- Indiana Jones • F19 Stealth Fighter • Wicked 30 Game Pack •

- Another 50 great games
- Microswitch Fighter joystick
- Dust Cover
- Mousemat

ALL THIS COULD BE YOURS - JUST CALL

0839 550 060

ENTER AS MANY TIMES AS YOU LIKE. IF YOU DON'T RING YOU CAN'T WIN
So call now to win this fantastic prize

Calls cost 36p (cheap rate) and 48p (at all other times) per min. inc. VAT
T.P.P. Ltd, Berwick upon Tweed TD15 1AB. Please ask permission before you call

Your name may be passed on to other responsible companies who may send special offers and promotional literature. If you do not want this please write to the above.

LOWEST PRICES GUARANTEED!



CORTEX 1/2 Mb RAM EXPANSION for the Amiga A500

Essential A500 upgrade - 1Mb Amiga is now standard • Functional equivalent to A501 • Lower power 1Mbit DRAM • Latest technology high-quality components • 'Fatter Agnus' compatible for 1Mb CHIP MEM • Low profile enable/disable switch • Available with or without battery-backed clock/ calendar module.

CLOCK £24.95

£19.95

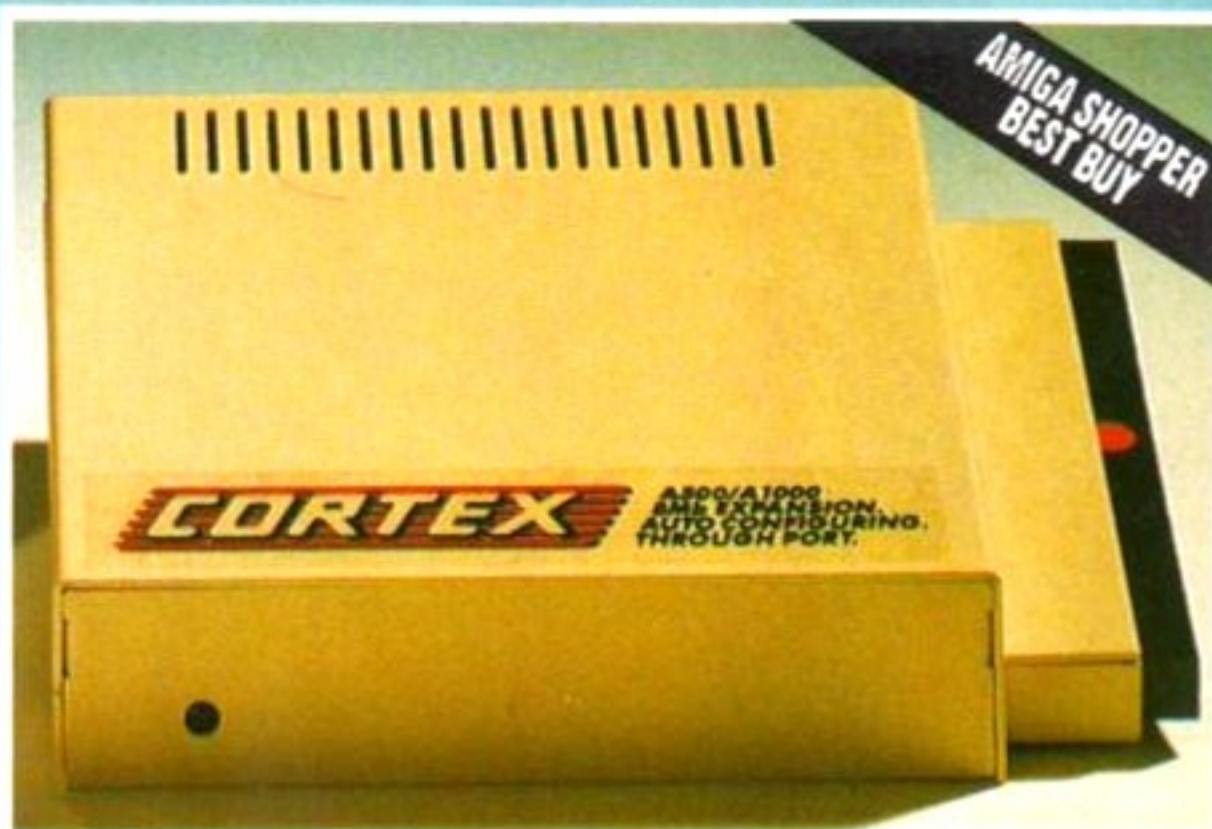

CORTEX 8Mb RAM EXPANSION for the Amiga A500/A1000/A500 plus

The **ONLY** RAM upgrade approved by Commodore UK • Fully compatible with A500 plus for 10Mb maximum RAM • External fitting (Warranty remains intact) • Through port (covered by blanking plate) • Fully implemented auto-configure • Zero wait states • Compatible with A590 and all major hard disks • Uses 1M x 8bit or 1M x 9bit SIMMs • Complete with its own power supply unit (UK, US, or EURO) • Fully A1000 compatible • RAM test software.

2Mb
£189.00

4Mb
£249.00

8Mb
£369.00



GVP 8Mb RAM EXPANSION for the Amiga A1500/A2000

Fully implemented auto-configure • Zero wait states • Uses 1M x 9bit SIMMs 2,4, or 8Mb configurations.

2Mb £169.00

4 Mb **£245.00** 8 Mb **£369.00**

GVP IMPACT SERIES 2 HARD DISK WITH RAM (A500HD8+)

52Mb Hard disk system with up to 8Mb of RAM • Factory-fitted Quantum Pro-drive, 11ms access • Uses 1M x 8bit SIMMs* (see RAM CHIPS section for prices) • Game switch (hard drive disable) and power supply.

52Mb
£359

105Mb
£499

240Mb
£799

GVP hard disks for A1500/A2000 also available.



EXTERNAL FLOPPY-DRIVE

High-quality silent mechanism • Through-port • Enable/disable switch.

£49.00

GVP FULL RANGE AVAILABLE INCLUDING NEW MINI-SLOT AT-EMULATOR. NB-PRICE PROMISE APPLIES!!

PRICE PROMISE

Cortex will match any genuine price offered by one of our U.K. competitors on goods that are in stock on a like-for-like basis. This offer applies at the time of purchase only and does not apply to prices offered in sales of bankrupt stock, clearance or closing down sales.

2 YEAR GUARANTEE

All product bearing the Cortex brand name carries a 2-year guarantee. Other products in this advertisement carry a 1 year guarantee. All prices include VAT and postage & packaging. All products shipped same day where possible. Allow 14 days for delivery if ordering by cheque. Make cheques/ P.O.'s payable to CORTEX..

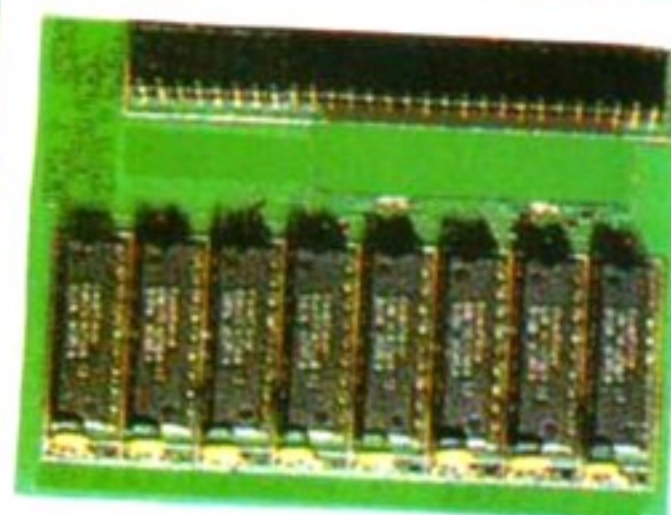

CORTEX 1 Mb MODULE FOR A500 plus

Gives 2Mb CHIP MEM • Functional equivalent to A501 plus • Ultra low power design • Low component count for maximum reliability • Available populated to 1/2MB or 1MB.

1/2 Mb
£29.95

1 Mb
£44.95

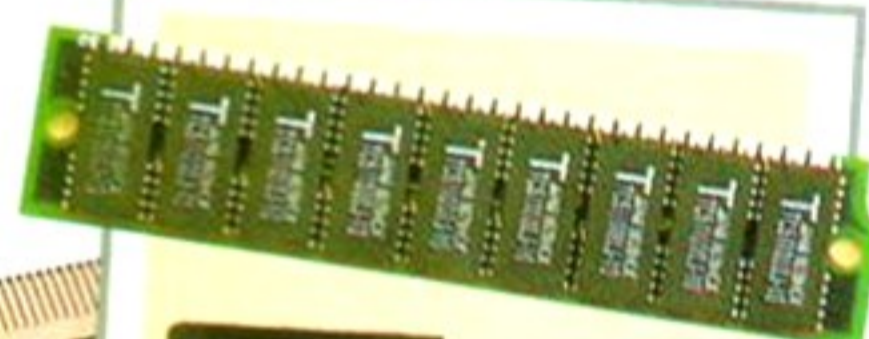

ENHANCED CHIP SET (E.C.S.) UPGRADES

8372A Fatter Agnus **£45.00**

8373 Super Denise **£45.00**

MegaChip 2000 with Super Agnus (allows 2Mb CHIPMEM to be fitted to A500/1500/2000)

See 'KICKSTART ROMS' For ROM upgrade. **£199.00**

RAM CHIPS

1M x 8bit SIMMs (for Cortex, GVP etc) EACH **£30.00**

4M x 8bit SIMMs (for GVP etc) EACH **£120.00**

256K x 4bit DIPs (for A590, 2091 ICD etc) EACH **£3.75**

1M x 1bit DIPs (for older A2000 cards) EACH **£3.75**

1M x 4bit Static-Column Mode ZIPs (for A3000) EACH **£20.00**



ROM SHARERS

Essential upgrade for all A500 & Plus owners • Enables safe and easy switching between 1.3 & 2.04 Kickstart ROMS • Keyboard controlled switching • Has 2 ROM sockets to allow for future expansion.

£29.95

As above but with 2-position slide switch **£19.95**

KICKSTART ROMS

V1.3 ROM **£29.00**

V2.04 KICKSTART ROM **£39.00**



DEPT AF, CORTEX DESIGN & TECHNOLOGY LTD, BRITANNIA BUILDINGS, 46 FENWICK STREET, LIVERPOOL L2 7NB. • 24 HOUR SALES TELEPHONE: 051-236 0480 24 HOUR FAX: 051-227 2482



Helping Hand

The old Helping Hand postbag has started to get a bit full of late, so **Maff Evans** has plunged his hand deep into its depths to try and help those who have been suffering for too long. So don't give up hope! Help is on its way.

Weaving a spell

I bought *The Secret of Monkey Island* and worked my way through to the end. It's a brilliant adventure so what do I do while waiting for *Monkey Island II*? I but the previous Lucasfilm adventure, *Loom*. Herein lies the problem. I can't get past the blacksmith's gate. If I go back to Rusty I can't wake him. I have tried all my known drafts on everything. Please help!

**GK Alder,
Langport, Somerset**

It looks as though your missing a spell! If you think back to the field with all the sheep, you may remember that they jump when you click on them... if you remembered to click on them, of course! The draft that they give you is a Wake-Up draft, so guess what you have to then use on Rusty!

Saints and cheaters

Can you please give me a cheat for *Xenon 2* because I can't get past level one. can you also give me a cheat for Saint Dragon? I can get stuck on level two.

**Darryn Durrant,
Croydon, Surrey**

Short and straight to the point, this letter! Well, Darryn, there isn't actually a cheat for Xenon 2 (sorry to everyone who wrote in asking for one), but I can help you with Saint Dragon.

Start the game as normal, then press the Caps Lock key and type DECAFFEINATED followed by Return. The top of the screen should then scroll to show that you have been given infinite lives.

Desert Island Disks

I have recently purchased *The Secret of Monkey Island* and have got completely stuck. I am on Monkey Island, I have got the oars to row the boat and have visited the cannibals' village. When they trap me in the hut I find the banana picker but it is too big to fit through the floorboards when I escape. How do I get it out? Also, how do I keep the fence down at the monkey head? When I let go of the totem pole's nose it just springs up again. Could you assist me?

**Matthew Rickhuss,
Castleford, West Yorkshire**

Well, you are most definitely on the wrong track, but you are trying to get too far ahead of yourself. You

can't actually take the banana picker out of the hut when you escape through the floor, that comes later when you've got something to give the natives. Unfortunately, you can't do this without getting past the fence by the monkey head! What you need for this is a small, hairy, monkey-shaped helper (who can be found in the forest near the beach). To get him to follow you, you need to feed him, but where do you get the bananas? The fruit basket in the village and the tree on the beach, that's where – but you have to work out how to dislodge the bananas from the tree! I'll leave you to work out this 'primitive' action (tee hee).

Tipping through the glen

£25 I am having great difficulty with *Robin Hood*. Does anyone know how to get Friar Tuck or anyone else to join your team? I can only get Little John, but when I send him out to mug one of the rich people, he gets caught and hung. Does anyone have any tips?

**G Roberts,
Edinburgh**

As luck would have it, we have a nice set of codes from Chris Hughes in Harrogate. Simply hold down the Alt key and enter these codes for special effects:

- 370 Outlaw stag hunting
- 371 Outlaw Robin Hood
- 372 Outlaw Merry Men
- 373 Put a price on Robin's head
- 441 Cycle through the seasons
- 213 Move to island near Little John
- 214 Move to spring near wizard
- 659 Make Merry Men join up
- 103 Make Marion Fall in love with Robin
- 166 Maximum heroism
- 167 Minimum heroism (not a great move)
- 828 Legalise Robin Hood
- 666 Start a church service

Lights – underwater car – ACTION!

I have got a copy of *The Spy Who Loved Me*. Is there anyone out there who knows how to skip levels? I'm bored of having to repeat scene one every time I want to play the game.

**Spencer Gamble,
Oakham, Leicestershire**

Well, there isn't actually a level-skip cheat, but there is another tip that may help. Start the game as normal,

then stop the car and type MISS MONEYPENNY. You should now have infinite lives and as much cash as you can wave a very wavy thing at. That should help you bash level one on the head with ease.

Driven up the wall

I am writing to you in the hope that you can advise me on software for the A500 Plus. My eldest son has had an A500 for almost two years and has bought many games. My youngest son has just had an A500 Plus for Christmas and is particularly disappointed that his favourite game *Lotus Esprit Turbo Challenge* will not work. Please could you tell me whether there is a Lotus-style game available for the A500 Plus, since my youngest son is getting more and more disheartened!

**Mrs JM Ashley,
Norfolk**



Want to see some hot driving on the A500 Plus? Well this little beauty could be right up your street! Grab a copy of Lotus Turbo Challenge 2 for some speedy action.

Not really a tip question, but when someone is getting distressed about a particular game, Helping Hand is there to assist! There is a Lotus-style game available that does work on the A500 Plus. Funnily enough it's the sequel game from Gremlin themselves – Lotus Turbo Challenge 2! This was released when the requirements of the A500 Plus were more widely known, and so should work without any problems.

Well that's about it for this month. There's just enough space for me to stick in a note...

Please, please don't write asking me to send full solutions of games through the post! There are quite a few of you asking for them and I just don't have the time to do it. The *Screenplay* books are both available, so if you turn to Page 108 and check the advert to see if the hints you are after are in there. If not, then try writing to Helping Hand with your problem and I'll try to sort it out. Byeeeee!

If you're stuck on a particular game or have a solution to a letter printed in the magazine, then write it down and send it in to us at **HELPING HAND
Amiga Format, 30 Monmouth Street, Bath BA1 2BW.**

The ultimate games guide is back by popular demand!

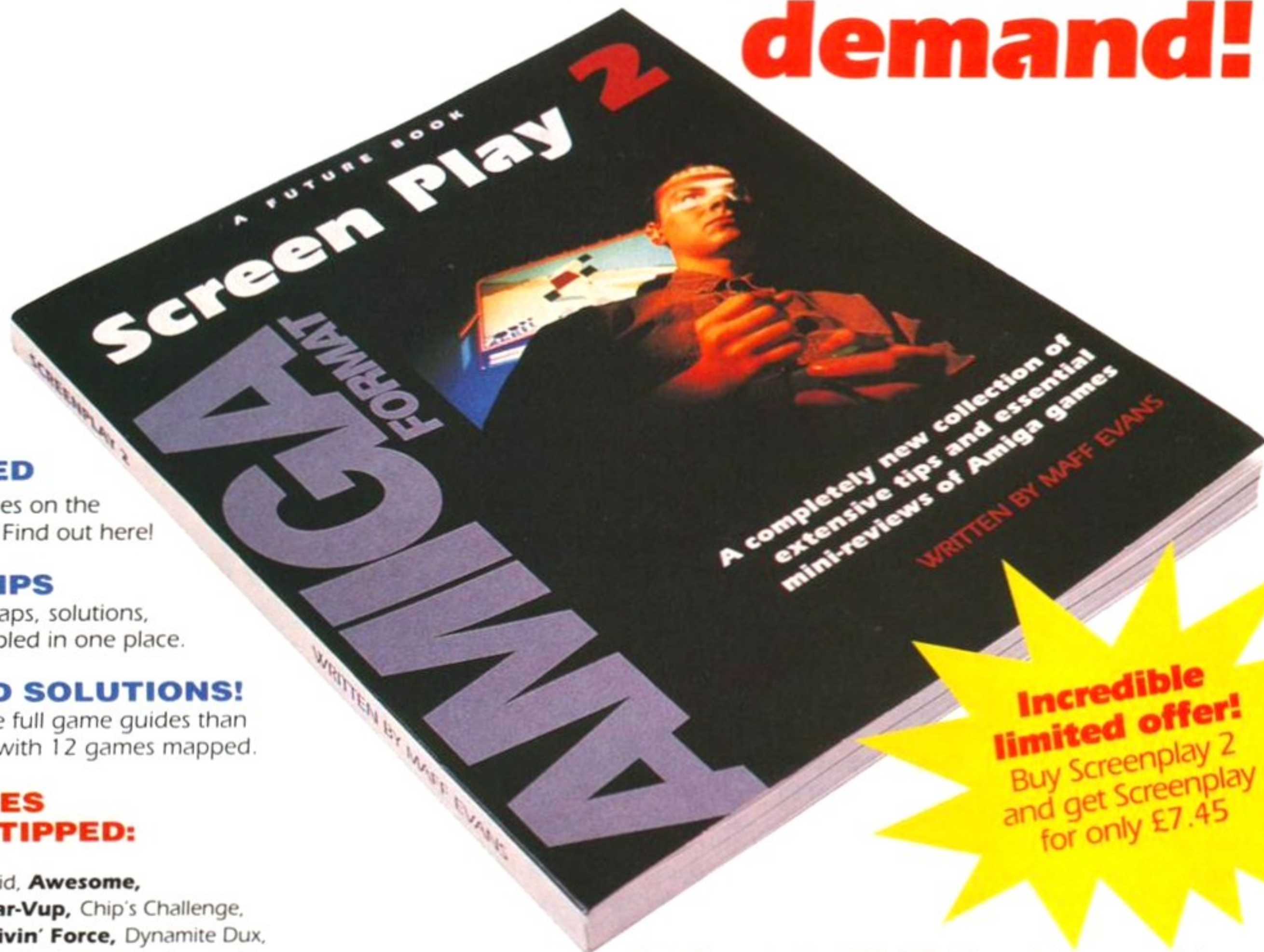

OVER 100 GAMES REVIEWED

Want to know the top games on the Amiga, both new and old? Find out here!

180 PAGES OF TIPS

The biggest collection of maps, solutions, cheats and tips ever assembled in one place.

MORE MAPS AND SOLUTIONS!

Screen Play 2 features more full game guides than any book ever has before, with 12 games mapped.

ALL THESE GAMES REVIEWED AND TIPPED:

Archipelagos, Atomic Robokid, **Awesome**, Back to the Future II and III, **Car-Vup**, Chip's Challenge, **Chuck Rock**, Crackdown, **Drivin' Force**, Dynamite Dux, **E-Motion**, Empire Strikes Back, **ESWAT**, Ghostbusters 2, **Ghosts 'n' Goblins**, Gremlins 2, **Hammerfist**, Horror Zombies, **The Immortal**, Ivanhoe, **Kid Gloves**, Killing Game Show, **LED Storm**, Line of Fire, **Llmatron**, Lotus Esprit Turbo Challenge, **Manic Miner**, Midnight Resistance, **Monty Python's Flying Circus**, Narc, **Ninja Spirit**, Nitro, **Operation Thunderbolt**, Predator 2, **Robocop 2**, Saint Dragon, **SCI**, Shadow Warriors, **Skidz**, Spherical, **Spy Who Loved Me**, SWIV, **Teenage Mutant Hero Turtles**, Toki, **Turrican**, Turrican 2, **Virus**, Viz, **Z-Out**.

PLUS FULL SOLUTIONS FOR:

Cruise for a Corpse, Dragons Lair II, **Fantasy World Dizzy**, Indiana Jones III, **Leisure Suit Larry**, Maniac Mansion, **Rick Dangerous 2**, Rise of the Dragon, **Search for the King**, Secret of Monkey Island, **Time Machine**, Treasure Island Dizzy, **Wonderland**

AND ALSO EXTENSIVE PLAYERS' GUIDES FOR:

Armour-Geddon, **Battle Command**, Captive, **Carrier Command**, Deuterios, **Dragons Breath**, Eye of the Beholder, **Full Contact**, Gods, **Hero Quest**, Indianapolis 500, **James Pond**, Lemmings, **Mean Streets**, Pang, **Prince of Persia**, Speedball 2, **Spindizzy Worlds**, Supercars 2, **Warhead**

**Incredible
limited offer!**
Buy Screenplay 2
and get Screenplay 1
for only £7.45

Costing only £9.95 The ultimate guide to Amiga games has been succeeded by an heir. **Maff Evans** has spent months putting together a brand new collection of top tips, helpful hints and informative reviews.

ORDER FORM

I would like to order ____ copy/copies of
SCREENPLAY 2

at the price of **£9.95 (+1.45 per copy P&P)**

I would like to order ____ copy/copies of
or SPECIAL LIMITED PERIOD OFFER

both SCREENPLAY1 and SCREENPLAY 2

at the price of **£17.40 (+1.45 per copy P&P)**

Please send payment with this order form in a
sealed envelope to:

AMIGA FORMAT SCREENPLAY 2 Book

FREEPOST

Future Publishing Ltd

Somerton, Somerset TA11 7BR

No stamp required if posted in the U.K.

Please allow 28 days for delivery.

Name _____

Address _____

Post Code _____

Telephone _____

I enclose cheque/PO for £ _____

Please debit my Access/Visa card: (delete as appropriate)

My card no. is _____

Expiry date _____

Signature _____

OR Phone our credit card hotline 0458 7401

**You know what you want
from your computer, that's
why you're choosing AMIGA**

**...NOW YOU'VE CHOSEN THE RIGHT
COMPUTER, MAKE SURE YOU CHOOSE
THE RIGHT DEALER**

Anyone can be good at selling Amiga or CDTV, but sadly, that's often where it ends. So, when it's time to choose the best computer, it's also time to find the best supplier. The one who is not only always competitive, but the one who also gives you the best possible ongoing support for you and your system.

Gordon Harwood Computers, Pioneers of the 'Complete Pack' approach, have specialised in Commodore, from the earliest VIC 20, to the latest Amiga, for almost a decade... In fact, we've supplied so many, if you ask all your friends, the chances are that some of them can tell you already of our excellent service.

Our service means that we'll help you get the most from your new system straight away. But, if you do have problems, and need that extra hand, that's where we have earned our reputation.

If you'd like all this, and more:

- 1 FRIENDLY AND HELPFUL EXPERT ADVICE
- 1 UNLIMITED ACCESS TO CALL IN SUPPORT AND EX-DIRECTORY TELEPHONE TECHNICAL HOTLINE
- 1 ALL ADVERTISED PRICES FULLY VAT INCLUSIVE
- 1 SHOWROOM DISPLAYS OF OUR EXTENSIVE RANGE OF HARDWARE, SOFTWARE AND PERIPHERALS
- 1 EXPRESS COMPUTERISED MAIL ORDER, STOCK WARRANTY AND CUSTOMER SUPPORT SYSTEM
- 1 COMPREHENSIVE INSTRUCTIONS WITH ALL SYSTEMS HARDWARE AND HELP BULLETINS WHERE REQUIRED
- 1 FREE COLLECTION OF MAJOR HARDWARE ITEMS REQUIRING IN WARRANTY SERVICE
- 1 NEW PRODUCT 30 DAY REPLACEMENT GUARANTEE
- 1 EXPERIENCED AND TRAINED SERVICE TECHNICIANS
- 1 AND OF COURSE, THE MOST COMPREHENSIVE RANGE OF REALLY COMPETITIVE PRODUCTS AND PACKS ANYWHERE!

**GORDON
HARWOOD
HARWOOD
HARWOOD**
Computers

**The Closer you look,
The Better we look.**

STOP PRESS...STOP PRESS...STOP PRESS...STOP PRESS
NEW 1Mb. AMIGA A600 RANGE
AT FANTASTIC PRICES

As this issue of the magazine was going to press, Commodore announced these new models - due for release at the end of April 1992.

The details below are provisional, but rest assured the multi title Powerplay pack we are putting together around the 600 will include as usual, a superb value collection of high quality software and accessories. By the time you read this, our plans should be finalised.

PLEASE CONTACT US FOR UP TO THE MINUTE PACK INFORMATION AND AVAILABILITY.



**TWO MODELS: A600 FD Single 3.5" 880Kb. Floppy Drive
A600 HD Single 3.5" 880Kb. Floppy Drive with internal 20Mb. Hard Disk Drive.**

These two latest additions to the Amiga family introduce some stunning new features...

COMPACT DESIGN: With built-in modulator for smaller desktop footprint.

SMART CARD SLOT: For instant software loading and future expansion.*

COMPATIBLE: With virtually all Amiga A500+ software. 1Mb. RAM: Expandable to 2Mb. internally with Real Time Clock.*

IN HOME SERVICE: Means should a hardware fault develop, a technician will visit your home to service or replace your computer, normally within four working days...FREE!

**It is important to note that the sidecar expansion bus & RAM expansion slot are different from those found on the original Amiga A500 and the current Amiga A500+ computers. Existing Amiga owners who have peripherals which connect in these ways who wish to upgrade computers, should consider whether the new A600 or its recently launched partner in the Amiga range, the A500+, is the most appropriate for their needs. Please contact us if you would like to discuss these technical matters in more detail.*

INTERFACES: 2 Mouse/Joystick ports, Parallel Centronics, Serial RS232, External Floppy Drive, Direct RF TV Output, RGB Analogue, Composite Colour Video, Stereo Audio, Smart Card Slot, Memory Upgrade Port.

A570 & A670 CD ROM DRIVES ▶▶

These fantastic CD ROM Drives will allow you to access the growing range of Interactive CDTV Titles for around £299* and also play your audio CD collection through your stereo! Simply plugs into your Amiga 500+ or A600 for immediate use. [*RRP, compatibility and release details yet to be confirmed by Commodore UK* - Please telephone for further information]



Apple™ in Alfreton...

For the professional user, Gordon Harwood provides the outstanding Apple™ Macintosh™ range of most user friendly yet powerful Personal Computers, at prices which compare favourably with Amigas.

Systems start at just £699.95 for a 40Mb. Drive Macintosh™ Classic™, with Monochrome Monitor and 4Mb. RAM. Colour systems are now available at a lower cost than the equivalent Amiga 1500 or 2000, but with much more useable power.

The Laser-Quality Style Writer™ Ink-Jet printer with automatic sheet feeder is just £299.95 to complete the whole package.

Macintosh™ is the industry standard system for DTP and presentation, it can also exchange files with MSDOS PC's and even run MSDOS programs [with SoftPC™, a standard utility package... available separately].

As an Apple Authorised Reseller, systems are available through our showroom only. Please visit us for your personal introduction to these exceptional computers.

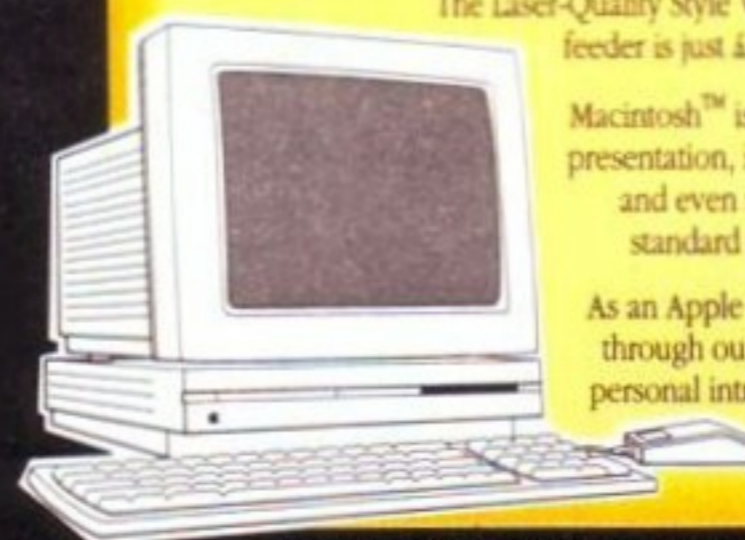

Gordon Harwood
Computers



Authorised Reseller

CARTOON CLASSICS MEGA 31*

New GORDON 31* MEGA GAME 1Mb.

HARWOODS POWERPLAY PACK 1 COMES OF AGE WITH 31* GREAT GAMES & A 1Mb AMIGA A500 PLUS CARTOON CLASSICS WITH THE SIMPSONS, LEMMINGS AND CAPTAIN PLANET PLUS 28* EXTRA GAMES ONLY FROM HARWOODS!!!

ALL OUR AMIGAS ARE UNITED KINGDOM SPECIFICATION AND INCLUDE THE FOLLOWING...

- 1 Mb. Disk Drive
- 1Mb Ram Memory
- TV Modulator
- 4096 Colours
- Multi Tasking
- Speech Synthesis
- 4 Channel Digital Stereo Sound
- Amiga Mouse
- Operation Manuals
- Workbench 2 Disks
- ALL Connecting Cables

PLUS...All OUR Amigas are backed by Harwoods Great Service

[Please see full details in our Ordering Made Easy panel final page]*



THAT'S RIGHT HARWOODS HAVE PUT TOGETHER THE ULTIMATE AMIGA PACKS YET AGAIN... STARTING WITH POWERPLAY PACK 1 WHICH INCLUDES 31* GREAT GAMES!

Just look at what you get NOW...

- **AMIGA A500 PLUS COMPUTER WITH A FULL 1Mb. OF MEMORY!**
- **THE SIMPSONS, BART vs THE SPACE MUTANTS** - That's right man! you can play the computer version of this popular TV cartoon. By Ocean.
- **CAPTAIN PLANET** - created from the award winning TV show, now's your chance to save the earths environment with this ultimate adventure... your Eco-Copter is waiting. By Mindscape.
- **LEMMINGS** - Are you as smart as Lemmings are stupid, match your intelligence against their lack of it as you play the 140 levels of the most original game of '91 (European Computer Leisure Awards Winner). By Psygnosis.
- **EDUCATIONAL BASIC LANGUAGE FOR CREATING YOUR OWN PROGRAMS**
- **DELUXE PAINT III GRAPHICS PACKAGE WITH ANIMATION**
- **TAILORED DUST COVER AND MOUSE MAT**
- **AND A SUPERB HIGH QUALITY MICROSWITCHED JOYSTICK,**
- **PLUS.... 18 MORE GREAT GAMES, THERE'S SOMETHING FOR EVERYONE...**
 - BLOODWYCH** - Fantasy role-playing game, great interaction with your computer created environment
 - BUBBLE+** - Help the dawdling ghost and the soap bubble, escape from the old deserted manor house
 - CAPTAIN BLOOD** - Astonishing creatures and animated 3D graphics, this is a game you just have to play
 - ELIMINATOR** - A progressive multi stage flying shoot 'em up, on a long winding course, survive if you can!
 - HOSTAGES** - You must get your team and hostages out of the terrorist overrun embassy, without loss of life
 - JUMPING JACKSON** - In a deluge of colour and sound save, the earth from sadness and melancholy music
 - KRYPTON EGG** - A classic Breakout game, 60 screens, separated by 6 combat sequences
 - LANCASTER** - Your mission is to fly the classic WWII bomber on its dangerous raids over enemy territory
 - LOMBARD RAC RALLY** - You drive your 300 bhp Sierra Cosworth through demanding stages of the rally
 - PURPLE SATURN DAY** - Four arcade games, an exciting high speed trip into total cosmic 3D space
 - SAFARI GUNS** - Live the African experience in an animal sanctuary, track the poachers & ivory traffickers
 - STIR CRAZY** (Featuring Bobo) - Bobo & his inmates are planning a stunning trampoline jump prison escape
 - SKYCHASE** - Airborne combat for every simulation fan. In this one or two player game, battle against your MIG flying adversary in your F-16 Falcon.
 - SKYFOX II** - Skyfox II, the only ship fast enough to carry on the Skyfox legend. Fight to blow your federation enemies from the Galaxy, at speeds of 9000 kilometres/second!
 - STRIKE FORCE HARRIER** - Puts you in the cockpit of one of Britains most exiting fighter aircraft. Multiple skill levels let you progress to become an ace pilot
 - TINTIN ON THE MOON** - We've been captured by Colonel Jorgen and he's tring to scupper the moon mission. Come on Tintin, you're the only one who can save us, and be the first on the moon
 - TV SPORTS FOOTBALL** - Strap on your helmet for American football simulation that looks like the real thing.
 - XENON 2 MEGABLAST** - This time it's war! The Xenites are back and have thrown time itself into turmoil.

We reserve the right to substitute individual software titles or pack items should the need arise.

Our packs always contain Professional Games NOT PD or multi-game disk titles

CARTOON CLASSICS MEGA 31*

BUY YOUR AMIGA WITH 2Mb FOR ONLY £40 EXTRA!!!
(ie. 1Mb RAM Expansion)

See Page 4 overleaf for details

*** OUR POWERPLAY PACK 1 PREVIOUSLY CONTAINED 21 GREAT GAMES BUT, NOW WE'RE INCLUDING THESE 10 FANTASTIC BONUS GAMES... ...BUT ONLY WHILST STOCKS LAST!**

- DATASTORM** - The fastest shoot 'em up of all time! Defender with a vengeance!!!
 - DUNGEON QUEST** - Ultimate in multisensory gaming! The BEST graphic mysteries!
 - E-MOTION** - 50 levels of multi-coloured puzzles. A challenging emotional experience.
 - GRAND MONSTER SLAM** - Elves, Trolls, Goblins, Orcs, Dragons & Knights do battle!
 - RVF HONDA** - Formula 1 motorbike racing at 170mph on a Honda RC30 racing bike!
 - DRIVIN' FORCE** - For driving maniacs! 12 competitions day or night with 6 vehicles!
 - PIPEMANIA** - Classic puzzle arcade game. So addictive you won't want to put it down!
 - ROCK 'N' ROLL** - Crazy action game accompanied by fantastic Rock 'n Roll sounds!
 - SKWEEK** - Paint the town PINK, kill Schnoreuls and dominate 99 levels of Skweezland
 - TOWER OF BABEL** - Intricate 3D strategy game. Fantastic lighting & shading effects!
- ...AND HARWOODS ALSO GIVE YOU A SUPERB BROCHURE OFFERING UP TO 16 NIGHTS FREE HOTEL ACCOMODATION IN AN EXTENSIVE SELECTION OF 400 HOTELS AROUND THE UK PLUS NOW A SPECIAL BUDGET FRANCE SUPPLEMENT IS INCLUDED TOO!

Priced at an **INCREDIBLE**

£399.95

Including VAT

HARWOOD

POWERPLAY PACKS

All our packs contain the new Amiga A500 Plus.
(1.3 Amigas may still be available to special order, please enquire.)

HARWOOD'S BRILLIANT 1Mb AMIGA 500 PLUS 'MEGA 31' GAMES PACK 2

That's right you get the fantastic Amiga & ALL THE EXTRAS detailed in Harwoods "Mega 31" Pack 1 AND you also get...

THE PHILIPS CM8833/II STEREO COLOUR MONITOR



Our monitor section on page 6 gives full details for your choice of Philips Monitors & Monitor TV's

MEGA 31*

MONITOR PACK

2

PACK TWO

OR... YOU CAN CHOOSE A PHILIPS MONITOR TV AT NO EXTRA COST! See page 6 for FULL details of this remarkable Fast Text Monitor TV

BUY AN AMIGA WITH 2Mb FOR ONLY £40 EXTRA!!
(... 1Mb RAM Expansion included)

A SPECIAL PACK FROM HARWOOD'S YOU SEE AND HEAR THOSE GAMES WITH SUPERB CLARITY

£629.95 Including VAT

HARWOOD'S GREAT 1Mb AMIGA 500 PLUS 'MEGA 31' PACK 3

That's right you get the fantastic Amiga & ALL THE EXTRAS detailed in Harwoods "Mega 31" Games Pack 1 (far left) AND... then you also get...

THE SUPERB PHILIPS CM8833/II STEREO COLOUR MONITOR



Our monitor section on page 6 gives full details for your choice of Philips Monitors & Monitor TV's

MEGA 31*

MONITOR AND PRINTER PACK

3

PACK THREE

OR... YOU CAN CHOOSE A PHILIPS MONITOR TV AT NO EXTRA COST! See page 6 for FULL details of this remarkable Fast Text Monitor TV

Plus...

THE SUPER STAR LC 200 COLOUR PRINTER...



Featuring... 185/40 cps, Full Colour 9 Pin NLQ Dot Matrix Printer with a FREE Dust Cover and cable to your Amiga. (See printer panel for details)

IF YOU WISH, REPLACE THE LC200 WITH A CITIZEN SWIFT 8 COLOUR AT NO EXTRA COST!!! OR... IF YOU PREFER A 24PIN COLOUR PRINTER, JUST CHOOSE FROM OUR RANGE & ADD THE DIFFERENCE IN PRICE BETWEEN STARS LC200 & 'YOUR CHOICE'. (eg. Citizen 224, add just £50)

£829.95 Including VAT

"IT'S THE-BUSINESS"

A TRULY PROFESSIONAL PACKAGE SPECIFICALLY FOR THE BUSINESS MINDED AMIGA USER. THIS ONE SHOULD FULFILL EVERY AREA OF HOME BUSINESS YOU'RE LIKELY TO NEED!

THE BUSINESS PACK FROM HARWOODS INCLUDES ALL THE FOLLOWING...

AMIGA 500 PLUS WITH 1Mb. MEMORY

PHILIPS CM 8833/II STEREO COLOUR MONITOR
See Monitor Panel on Page 6 for Details

STAR LC200 9 PIN NLQ FULL COLOUR PRINTER
See Printer Panel on Page 5 for Details

A HOST OF BUSINESS SOFTWARE & ACCESSORIES...
PEN PAL V1.3 (Word Processor)...1Mb.
SUPERBASE II PERSONAL (Database) SUPERPLAN (Spreadsheet)...1Mb.

A GREAT TEN GAMES PACKAGE

Plus...
★ THE SIMPSONS
★ CAPTAIN PLANET
★ LEMMINGS
★ DELUXE PAINT III
Now with ANIMATION
★ MICROSWITCHED JOYSTICK
★ 10 BLANK 3.5" DISKS
★ DISK LIBRARY CASE
★ MOUSE MAT
★ 3 TAILORED DUST COVERS

ADD A CUMANA CAX 354 SECOND DRIVE FOR JUST £50 TO HELP RUN THOSE BUSINESS PACKS MORE EFFICIENTLY

WE MEAN BUSINESS AT A GREAT PACKAGE PRICE OF JUST...

£899.95 Including VAT

CARTON CLASSICS

POWERPRO PROFESSIONAL PROFESSIONAL PACK

OR... YOU CAN CHOOSE A PHILIPS MONITOR TV AT NO EXTRA COST! See page 6 for FULL details of this remarkable Fast Text Monitor TV

BUY AN AMIGA WITH 2Mb FOR ONLY £40 EXTRA!!
(... 1Mb RAM Expansion included)

IF YOU WISH, REPLACE THE LC200 WITH A CITIZEN SWIFT 8 COLOUR AT NO EXTRA COST!!! OR... IF YOU PREFER A 24PIN COLOUR PRINTER, JUST CHOOSE FROM OUR RANGE & ADD THE DIFFERENCE IN PRICE BETWEEN STARS LC200 & 'YOUR CHOICE'. (eg. Citizen 224, add just £50)

HARWOODS LEARN & PLAY

PRIMARY & JUNIOR PACK A

Get your children off to the right computing start with this software learn and play Compendium 6 pack...

KIDS TYPE, WEATHER WATCHER, CALENDAR QUIZ, WORDS & NUMBERS, GAME SET & MATCH, WHAT IS IT? - WHERE IS IT?

Active, enquiring young minds will love the fun of these six entertaining but educational titles. Your children probably won't even realise that their "lessons" have begun!!!

HOMEBASE
Ideal home storage system. Keep household lists, student records etc. Easy to use "push button" controls.

PRIMARY MATHS COURSE
Around 24 modules in this course from 3 yrs old right up to secondary level. Follows N.C.

READING & WRITING COURSE
24 module course. Teaching from the computer and books. For early starters & the dyslexic.

A GREAT EDUCATIONAL PACK FOR YOUR CHILDREN AT A FRACTION OF THE NORMAL COST

£69.95 Including VAT

EDUCATION

A

PACK A

HARWOODS LEARN & PLAY

GCSE/'O' LEVEL PACK B

GCSE examination level studies on your Amiga computer that's fun!

MICRO ENGLISH, MICRO FRENCH AND MICRO MATHS

A set of three complete self-tuition courses to GCSE level which can also be used for revision work. All programs adhere to the National Curriculum and were designed and tested in schools by professional teachers. Micro French includes "real speech" to help your accent!

PEN PAL - Graphical Word Processor
A fantastic word processor with all the tools you'll need to create effective written work. Ideal for home work, projects etc. or for the families letters. Text wraps automatically around graphics, even as you type! Includes a built-in database and Forms Manager.

HOMEBASE
Homebase is the ideal information storage program for things like household lists, student notes, and children's educational projects. Inc. clearly labelled "push button" controls and clear comprehensive reference manuals.

A GREAT EDUCATIONAL PACK FOR YOUR CHILDREN AT A FRACTION OF THE NORMAL COST

£89.95 Including VAT

EDUCATION

B

PACK B

Enquiries & Order Line:

0773 836781

Finance Facilities Available*
Please phone us for information and your personal application pack.

GORDON HARWOOD HARWOOD HARWOOD

Computers

ALFRETON DERBYSHIRE

*The Closer you look,
The Better we look.*

VISA

MasterCard

*Finance terms are available (subject to status) for most products; please see our ordering panel at the end of this advert for full details

SOUND AND VISION

Words and Pictures

CDTV



IMAGINE, IF YOU CAN, THE CONCEPT OF A NEW, MORE POWERFUL AMIGA...

...WITH 1 MEGABYTE OF MEMORY, AND A COMPACT DISK DRIVE OF ALMOST INFINITE SIZE. A DISK DRIVE SO VAST, IT CAN STORE HUNDREDS OF MILLIONS OF DIGITS OF DATA. THIS DATA COULD BE, SPEECH, ANIMATED PICTURES, DIGITISED STEREO SOUND, COMPUTER IMAGES OR WHOLE ENCYCLOPAEDIAS.... AND MORE.

IMAGINE THIS, AND YOU CAN START TO GRASP THE CONCEPT OF CDTV.

THE INTEGRAL COMPACT DISK DRIVE, IS THE KEY TO THE POWER OF CDTV. ITS STORAGE CAPACITY IS EQUIVALENT TO AROUND A QUARTER OF A MILLION FULL PAGES OF TEXT. THIS WHEN INTEGRATED WITH THE 1 MB OF INTERNAL AMIGA CIRCUITRY, CREATES A SYSTEM, WHICH FROM A CD DISK, CAN GIVE YOU ACCESS TO AN UNIMAGINABLE SPECTRUM OF REAL WORLD IMAGES, NEVER SEEN COMBINED BEFORE. THESE VIVID IMAGES, WITH WORDS AND SOUNDS, GIVE YOU A WHOLE NEW DIMENSION IN HOME EDUCATION, ENTERTAINMENT & INFORMATION TECHNOLOGY. AND... DON'T FORGET, THAT CDTV CAN PLAY IN SUPERB QUALITY, ANY NORMAL AUDIO MUSIC CD, AND IT CAN ALSO PLAY THE NEW CD+G DISKS, WHICH GIVE DIGITAL SOUND AND ON SCREEN GRAPHICS.

ON CD DISKS NOW AVAILABLE, THERE ARE EDUCATIONAL PACKAGES, ENCYCLOPAEDIAS PACKED WITH REFERENCE INFORMATION, STUNNING GAMES, MUSIC SYSTEMS AND MANY OTHER NEW AND VARIED SUBJECTS, INCLUDING WHOLE WORLD ATLASES OR EVEN THE COMPLETE WORKS OF SHAKESPEARE, EACH ON ONE CD DISK!! CDTV - NOTHING LESS THAN REVOLUTIONARY

FREE CDTV STARTER PACK!!!

WHEN YOU CHOOSE YOUR CDTV FROM GORDON HARWOOD, NOT ONLY DO YOU GET OUR LEGENDARY SERVICE, BUT WE GIVE YOU A CDTV STARTER PACK, TO GET YOU EXPLORING YOUR NEW WORLD - STRAIGHTAWAY.

THIS INCLUDES A SUPERB SELECTION OF CD DISK TITLES INCLUDING THE WELCOME TUTORIAL & HUTCHINSONS ENCYCLOPAEDIA, PLUS ... FIVE GAMES, SHERLOCK HOLMES & THE HOUND OF THE BASKERVILLES, SIM CITY, CHAOS IN ANDROMEDA, A TOWN WITH NO NAME, AND THE ACCLAIMED LEMMINGS, WORTH IN TOTAL ALMOST £200.00.

IN ADDITION IS THE INFRARED REMOTE CONTROLLER, AND ALL THE HARDWARE NEEDED TO GET YOU CONNECTED.

ALL THIS FOR JUST £499.95

CDTV IS THE SAME SIZE AND STYLE AS MOST VIDEO RECORDERS, SO IT CAN SIT UNOBTRUSIVELY ABOVE OR BELOW YOUR HOME TV AND/OR HI-FI. AND WITH ITS INFRARED REMOTE CONTROLLER, IT CAN BE OPERATED FROM YOUR ARMCHAIR. BUT PERHAPS MOST IMPORTANTLY, IF YOU ARE A COMPUTER ENTHUSIAST, REMEMBER THAT INSIDE EVERY CDTV, IS AN AMIGA, JUST WAITING TO BE USED. SO LATER ON, YOU'LL BE ABLE TO BUY THE OPTIONAL KEYBOARD AND DISK DRIVE, TO GET INTO THE WORLD OF AMIGA COMPUTING. PRINTERS, DIGITISERS, GENLOCKS AND OTHER ACCESSORIES, CAN ALL BE CONNECTED TO GIVE ACCESS TO MANY OTHER EXCITING FACILITIES, AND ALSO MANY OF THE EXISTING SOFTWARE PACKAGES AVAILABLE FOR THE AMIGA COMPUTER. NEVER BEFORE HAS THERE BEEN SO MUCH POTENTIAL FROM ONE NEW STUNNING SYSTEM, PACKED WITH

TODAYS TECHNOLOGY.!

CALL IN AND SEE US FOR YOUR PERSONAL DEMONSTRATION, OR PHONE US FOR YOUR FREE DETAILED CDTV INFORMATION PACK.

CDTV ACCESSORIES Please call for latest availability.

CD 1220 KEYBOARD	AN 89 KEY QWERTY KEYBOARD	£49.95
CD 1252 MOUSE	INFRARED MOUSE WITH BATTERY SAVER.	£49.95
CD 1200 TRACKBALL	INFRARED TRACKBALL, WITH THE OPTION OF DIRECT CONNECTION TO EXTEND BATTERY LIFE. DUPLICATES FUNCTIONS OF 2 BUTTON MOUSE & INCLUDES TWO 9 PIN PORTS FOR STD. JOYSTICKS FOR HOLDING CD WITHIN DRIVE	£79.95
CD 1400 CADDY	PERSONAL RAM CARD CONTAINING 64K OF MEMORY FOR STORING DATA OR AS A BOOKMARK FACILITY WITHIN CDTV	£9.95
CD 1401 MEMORY CARD	A LARGER PERSONAL RAM CARD CONTAINING 512K OF MEMORY FOR STORING DATA OR AS A BOOKMARK FACILITY WITHIN CDTV	£79.95
CD 1405 MEMORY CARD	3.5" FLOPPY DRIVE WITH 880K CAPACITY. MATCHING BLACK FINISH. SUPPLIED WITH AMIGA WORKBENCH DISKS/MANUALS etc.	£249.95
CBM FLOPPY DRIVE	PAL BASED VIDEO INTERFACE CARD FOR SUPERIMPOSING CDTV IMAGES OVER A VIDEO SIGNAL PROVIDED BY ANY STANDARD VIDEO SOURCE	£99.95
CD 1301 GENLOCK	CDTV COMPATIBLE AND STYLED IN MATCHING BLACK.	£149.95
ROCLITE 3.5" DRIVE		£69.95

Many Amiga Accessories & Peripherals (e.g. Printers, Disk Drives, Software etc.) are compatible with CDTV. Please phone us for compatibility information.

HARWOODS AMIGA PRO-GEN NEW LOWER PRICE



PROFESSIONAL QUALITY GENLOCK FOR COMPUTER AND VIDEO MIXING, AT A DOWN TO EARTH PRICE!!!

Please note the above photograph shows Spectracolor which has now been replaced by Photon Paint 2.0

PRO-GEN Amiga Genlock

The Pro-gen AMIGA Genlock allows you to mix your Amiga display with any PAL video signal whether it is from a VCR, Laserdisk player or a Camcorder. In fact any item of video equipment which outputs a PAL composite video signal. Combined with the Amiga computer the Pro-Gen gives you the facilities of a special effects & video titling suite. Take your own films & give them a professional look by OVERLAYING TITLES or by SUPER IMPOSING YOUR OWN GRAPHICS created in packages like Photon Paint 2.0 or Deluxe Paint. Pro-Gen is supplied with micro illusions superb Photon Paint 2.0 package.

FREE Photon Paint 2.0 Software

A powerful Lo-and-Hi resolution hold and modify (HAM) paint program, with overscan (NTSC/PAL) and special effects for your Amiga Computer including all the following... **Contour Mapping:** drapes a brush over a 3D "landscape". Pixel intensity values decide the peaks and valleys, while a specially developed ray-tracing algorithm maps the image precisely. **Surface Mapping:** around 3D objects, both geometric and free hand drawn. **Luminance:** sets the light source and intensity. **Shadowing:** automatically with control of size and offset. **Brush Control:** twist, tilt, resize, flip, rotate, bend, adjustable transparency, stretch etc etc. PLUS LOTS MORE! A great program allowing use of 4096 colours. Choice of horiz/vert page print, negatives, anti-aliasing, dithered print, adjustable brightness etc.

How it works:

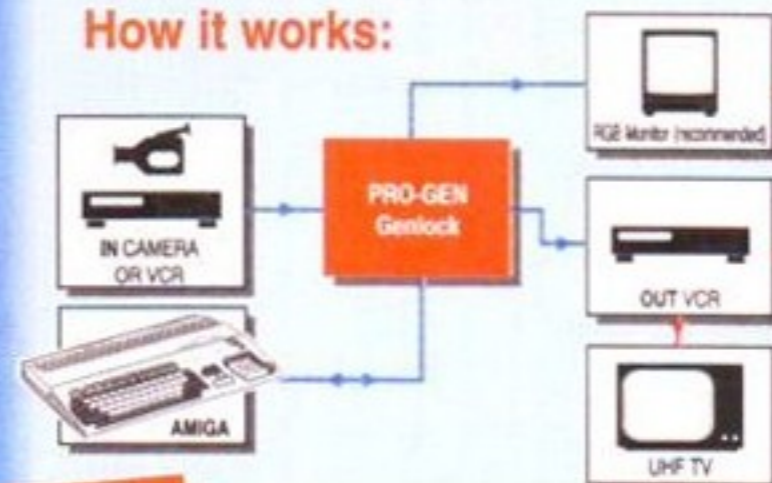

STOP PRESS

PRO-GEN... NOW INCLUDES A VERY VERSATILE MULTI COMPONENT VIDEO TO GENLOCK CONNECTING CABLE KIT. THIS ALLOWS PRO-GEN TO BE USED STRAIGHTAWAY WITH MOST POPULAR VIDEO EQUIPMENT, WITHOUT THE NEED TO HUNT DOWN THE CORRECT CONNECTING CABLES. THIS KIT CAN ALSO BE USED TO CONNECT IN OTHER WAYS... eg. VCR TO VCR etc. A KIT TO START YOU OFF RIGHT FROM THE MOMENT YOU OPEN THE BOX!!!

NEW LOWER PRICE

PRO-GEN with Photon Paint 2.0 **ONLY £99.95**

Mode Switch-box for Genlocks

Features Include
-Compatible With The Pro-Gen And Rendale 8802
-Supplied With Genlock Extender Cable Worth £9.95
-Switch-box Switches Between Foreground, Background, Video And Computer Modes.

£29.95

AMIGA DRIVES & MEMORY

Cumana CAX354 3.5" External 2nd Disk Drive.

- ☆ Features Include
- ☆ Long connecting cable
- ☆ 1Mb, (880K Formatted) Capacity
- ☆ Enable/Disable Switch,
- ☆ Throughport
- ☆ Access Light
- ☆ Compatible with Amiga500/1000 1500/2000/3000 and CDTV

NOW SUPPLIED WITH A FREE 3.5" Disk Head Cleaner to maintain your new drive in 'tip-top' condition.

£57.95



- ☆ Capacities of 52 to 420Mb
- ☆ Connects to sidecar bus on L/H side of A500/A500 Plus
- ☆ Autoboots with Kickstart 1.3/2.0, boot enable/disable switch
- ☆ Sockets for up to 8 Mb of RAM
- ☆ SCSI Port allows up to 7 other devices to be connected
- ☆ Supplied with easy to use software
- ☆ 2 Year Warranty ☆ Dedicated PSU
- ☆ Mini slot for future expansion
- ☆ PC-AT Emulator planned to be available for 1992

GVP AMIGA A500 HARD DRIVES

RAM SIZE	CAPACITY		
	52Mb.	120Mb.	240Mb.
0Mb.	£349.95	£519.95	£729.95
2Mb.	£419.95	£589.95	£799.95
4Mb.	£489.95	£659.95	£869.95
8Mb.	£629.95	£799.95	£999.95

GVP AMIGA 1500/2000 HARD DRIVES

RAM SIZE	CAPACITY			
	52Mb.	120Mb.	240Mb.	420Mb.
0Mb.	£289.95	£409.95	£639.95	£1169.95
2Mb.	£359.95	£479.95	£709.95	£1239.95
4Mb.	£429.95	£549.95	£779.95	£1309.95
8Mb.	£559.95	£679.95	£899.95	£1429.95

CALL FOR MEMORY UPGRADE PRICES IF YOU ALREADY ARE A GVP OWNER!

EDUCATION SOFTWARE

DON'T JUST PLAY GAMES WHEN YOU CAN LEARN WITH YOUR AMIGA TOO!

- MICRO MATHS - 24 easy to use programs for GCSE (O' Level) revision or self tuition **£18.95**
- MEGA MATHS - A 9 level step by step tuition course. For mature beginners, 'A' Level studies & Micro Maths users **£20.95**
- MICRO FRENCH - GCSE French tuition or revision course. Covers both spoken & written French **£18.95**
- MICRO ENGLISH - Complete self-tuition programme to GCSE level. **£18.95**
- PRIMARY MATHS - Ages 3 to 12. Complete 24 Prog. Course. **£18.95**
- SPELL BOOK - Ages 4 to 6. Developed with the help of a Primary School Head Teacher to aid spelling skills. **£17.95**
- HOMEBASE - Home storage prog., ideal for those household lists, childrens educational projects, student notes etc. Easy to use "Push Button" controls and a extensive reference manual. **£19.95**
- COMPENDIUM SIX PACK - 6 Great Educational Progs. for children aged 4-12 years of age. Each is designed to keep your child's interest whilst they learn. **£29.95**
- KIDS TYPE - Large characters & colourful graphics helps creation of stories. **WEATHER WATCHER** - Collect & analyse data using graphs etc. even animate your own weather map! **CALENDAR QUIZ** - Quiz based learning of time related events. **WORDS AND NUMBERS** - Put words & sentences in the correct order or group numbers. **GAME, SET & MATCH** - Early learning of shapes colours, numbers, coins, sequences and including a "reaction timer". **WHAT IS IT? WHERE IS IT?** - Learn names & locations of British counties.

HARWOODS AMIGA 1Mb PRO-RAM PLUS

ADD MORE POWER TO YOUR AMIGA 500 PLUS WITH A FULL 1Mb. MEMORY UPGRADE!!!

- ☆ 1Mb. RAM expansion for the Amiga 500 Plus
- ☆ Gives a total of 2Mb. of RAM
- ☆ Easily fitted without any dismantling in the trapdoor expansion slot underneath Amiga. DOESN'T invalidate your warranty!
- ☆ Low power consumption ☆ 2 Yr Guarantee!

A GREAT NEW OFFER FROM HARWOODS

Only... **£44.95**

0.5 Mb PRO-RAM

- ☆ Compatible with Amiga A500 and 500 Plus
 - ☆ Gives A500 a total of 1Mb Memory + Clock
 - ☆ Gives 500 Plus a total of 1.5Mb Memory
- Only... **£29.95**

AMIGA SOFTWARE

- Music-X:** The ultimate software for professional MIDI sequencing. The software includes a configurable librarian and a synthesiser patch editor. All you need to recreate a song can be recalled from one performance file including sequences, MIDI routing, sync setup, keyboard maps & synthesiser or drum machine patch libraries. **NEW LOW PRICES - £49.95 or just £69.95 with midi-interface!**
- MIDI INTERFACE (5 Port):** In, Out, Through plus 2 switchable thru/out. Inc. 2 cables. **£24.95**
- AMOS:** AMOS allows you to access the power of the Amiga with ease. 500 different commands make AMOS a sophisticated development language. The AMOS animation language allows you to create complex animation sequences. 300 page manual and over 80 example programs **£49.95**
- Amos Add on Modules:** (BOTH require Amos prog.)
- Amos Compiler **£29.95** Amos 3D **£34.95**
- BUY ALL THREE AMOS PROGRAMS FOR JUST £89.95**
- SuperBase 4:** Most powerful database available for the Amiga. Combines the ease of use of SuperBase 2 with a versatile programming language so that you can tailor your data to your own specific needs for club/business/library records etc. **£229.95**
- Lattice C:** An ideal tool for the C programmer whether experienced or a novice. The best way to create applications for the Amiga. Fully supports Motorola chipset. Nearly 300 functions optimised to help the user write the tightest possible code. Includes screen editor. Most Amiga C books are based around lattice. (Requires either 2 floppy drives OR a hard disk drive) **£199.95**
- Deluxe Paint IV:** Latest version of the Amigas first, and still the best. paint and animation package, now including HAM mode. (1 Mb. minimum memory or more recommended) **£79.95**
- Vidi, The Complete Colour Solution:** Vidi with RGB Splitter, Frame Grabber & Digitiser. Grabs moving colour video into 16 grey scale frames (up to 16 frames in 1Mb. Amiga) and digitises from still colour video source in up to 4096 colours in less than 1 second! Requires home VCR or video camera for grabbing. Requires video camera or VCR with perfect pause for digitising. Now comes with Photon Paint 2.0 ABSOLUTELY FREE OF CHARGE!!! **£149.95**
- STEREOMASTER:** High quality "stereo" sampler (best for sampling instruments etc.) **£39.95**

THE ABOVE IS JUST A SMALL SAMPLE FROM OUR EXTENSIVE RANGE OF THOUSANDS OF SERIOUS, EDUCATION AND RECREATION TITLES. WE CAN'T LIST THEM ALL HERE SO PLEASE CALL US IF YOU CAN'T SEE THE PROGRAM YOU REQUIRE, IT'S PROBABLY IN STOCK!

Pen Pal V.1.3

WORD PROCESSOR/DATABASE
With Pen Pal you can mix text, 4096 colour graphics & data in ways no other w/p can! It's handling of graphics is unsurpassed: Pen Pal is the only word processor I tested that will automatically wrap text round graphics.

Amiga World, July '90

£79.95

PEN PAL complete WITH 512K Amiga RAM Expansion only...£99.95!



All our packs contain the new Amiga A500 Plus. (1.3 Amigas may still be available to special order, please enquire.)



Enquiries & Order Line:

0773 836781



Finance Facilities Available* Please phone us for information and your personal application pack.



GORDON HARWOOD HARWOOD HARWOOD
Computers

ALFRETON DERBYSHIRE

The Closer you look,
The Better we look.

FREE...
Fully Tailored
Dust Cover with all
Dot Matrix Printers

PRINTERS

**NEW FREE
ACCESSORIES**

All printers in our range include a standard Centronics/Parallel Port for direct connection to Amiga, PC's, Atari ST's, Archimedes etc.

We supply a connection cable to YOUR computer plus a Quality Dust Cover with ALL Dot Matrix Printers **FREE**



When you are comparing our prices to others make sure that the same essential items are included eg. Printer Lead, Dust Cover, Postage and VAT etc.

GORDON HARWOOD PRINTER STARTER PACK
ALL our Dot Matrix Printers are supplied complete with...
200 Sheets of Continuous Printer Paper
100 Useful Self Adhesive Continuous Labels
Amiga Printer Drivers Disk **FREE**

CITIZEN 120D+ 9 PIN MONO - Up to 120/25 cps **£149.95**
 Very reliable low cost printer with interchangeable interfaces for Centronics/RS232/serial type (C64 etc.) Full 2 Year manufacturers warranty

NEW FASTER STAR LC20 9 PIN MONO - Up to 150/38 cps **£159.95**
Replacement for our most popular Mono Dot-Matrix at a super low price
 Multiple font options easily accessible from front panel Simultaneous, continuous and single sheet stationery
 Excellent paper handling facilities 240 x 240 dpi Graphics

STAR LC200 9 PIN COLOUR PRINTER - 185/40 cps **£209.95**
This is the one in our packs!
 80 Column Dot Matrix Micro paper feed, Max. paper width 11.7"
 240 dpi - 9 Pin COLOUR Supplied with colour & mono ribbons
 16K Buffer, 8 Resident Fonts Paper park with auto single sheet loading
 Push/pull tractor & rear/bottom feeds Programmable from front panel.
 Reverse paper feeds 12 month warranty

CITIZEN SWIFT 9 PIN COLOUR - 160/40cps **£214.95**
New super high spec 9Pin colour printer
 8K Buffer 4 Fonts 240 x 240 dpi Colour Graphics
 Push and pull tractor built-in Best text quality in our 9Pin range
 Feed for labels/multi part stationery 2 Year Citizen warranty

STAR SJ48 INKJET PRINTER **£249.95**
New super high quality bubble ink jet printer
 64 Nozzle ink jet Large 28K Buffer
 Emulates Epson LQ and IBM 360 x 360 dpi near laser print quality
 Proprinter for full compatibility Optional Ni-Cad battery for mains free operation
 Complete with AC adaptor

STAR LC24/200 24 PIN MONO - 220/55 cps **£249.95**
Mono version of LC24/200 Colour, same spec except for a smaller 7K buffer

STAR LC24/200 24 PIN COLOUR - 220/55 cps **£299.95**
Colour version of the LC24-200 Mono.
 80 Column Dot Matrix Paper park with auto single sheet loading
 360 dpi - 24 Pin MONO Micro paper feed, Max. paper width 11.7"
 30K Buffer (expandable) Supplied with mono ribbon
 10 Resident Fonts Faster than the old LC24-10
 Front Panel Pitch Selection Extra font cartridges available
 Push/pull tractor & rear/bottom feeds Program from front panel, No DIP switches
 Reverse paper feed 12 month warranty

NEW 24 Pin CITIZEN 224 COLOUR - 160/53 cps **£254.95**
Brand New, lowest cost colour 24 Pin printer, anywhere!
 80 Column Dot Matrix with 4 Fonts Push & pull tractor feeds
 360 dpi - 24 Pin COLOUR Complete paper parking facilities.
 8K Buffer expandable to 32K Supplied with mono & colour ribbons
 Easy to use front panel controls Full 2 Year Citizen Warranty

NEW 24 Pin CITIZEN SWIFT 24E COLOUR - 180/60 cps **£319.95**
Brand New, superb specification colour 24 Pin printer.
 80 Column Dot Matrix with 7 Fonts Push/pull & bottom tractor feeds
 360 dpi - 24 Pin COLOUR Complete paper parking facilities.
 8K Buffer expandable to 32K Supplied with mono & colour ribbons
 Easy to use LCD panel controls Full 2 Year Citizen Warranty

NEW FASTER STAR XB 24 PIN COLOUR RANGE XB24-200 & XB24-250 - 275/80 cps **£399.95** **Wide Carriage**
These NEW top of the range Stars replace the XB24/10 & XB24/15, & offer the best possible quality dot matrix printing
 Exceptional print quality Buffer: 29K(XB24/200) & 76K (XB 24/250)
 4 x 48Pin super letter quality fonts 360 x 360 dpi Colour Graphics
 14 x 24Pin near letter quality fonts 12mths on-site warranty (UK Mainland)

HEWLETT PACKARD PAINTJET COLOUR A4 INKJET **£579.95**
Our best quality full colour printer at a realistic price
 Parallel/Centronics or Serial RS232 I/F (specify with order, MAC option available)
 For presentation graphics/DTP, CAD and technical/scientific applications
 A full page of colour graphics in 4 minutes (typical)
 Non impact printing, Will print transparencies
 virtually silent, 43dba 12 Months on-site warranty (UK Mainland)

STARSCRIPT - 4ppm POSTSCRIPT COMPATIBLE LASER **£1099.95**
A4 Laser Printer, will connect to PC, Amiga, Atari ST, Macintosh etc.
 300 DPI, 2Mb. Upgradable to 5Mb. Serial and Parallel Interfaces
 Emulations inc: HP Series II, Epson EX800, IBM Proprinter & Diablo 630 12month on site warranty (UK Mainland)
 Complete with "Starscript" (Stars postscript language emulation) 49 quality fonts built-in
 Appletalk for connection to Macintosh Every desktop publishers dream

SEE OUR LIST OF ACCESSORIES FOR BOTH STAR AND CITIZEN PRINTERS, ALL AT COMPETITIVE PRICES!
All the characters Per Second speeds quoted above are Draft/LQ at 10cpi

PRINTER ACCESSORIES

CITIZEN PRINTER ACCESSORIES:

Citizen 120D+ Sheet Feeder **£69.95**
 Citizen 120D+ Parallel Interface **£49.95**
 Citizen 120D+ CBM C64 Serial Interface **£49.95**

Citizen 124D 32K Buffer **£13.95**
 Citizen 124D Semi-Auto SheetFeeder **£39.95**
 Citizen 124D Automatic Sheet Feeder **£79.95**
 Citizen 124D Printer Stand **£24.95**

Citizen Swift 9 Semi-Auto SheetFeeder **£39.95**
 Citizen Swift 9 Automatic Sheet Feeder **£79.95**
 Citizen Swift 9 Printer Stand **£24.95**

Citizen Swift 9X Printer Stand **£34.95**
 Citizen Swift 9X Automatic Sheet Feeder **£139.95**

Citizen Swift 24 32K Printer Buffer **£13.95**
 Citizen Swift 24 Semi-Auto Sheet Feeder **£39.95**
 Citizen Swift 24 Automatic Sheet Feeder **£79.95**
 Citizen Swift 24 Printer Stand **£24.95**

Citizen Swift 24X Auto Sheet Feeder **£139.95**
 Citizen Swift 24X Printer Stand **£34.95**

HEWLETT PACKARD PAINTJET PRINTER ACCESSORIES:

Hewlett Packard PaintJet
 Black Ink cartridge **£25.95**
 Colour Ink Cartridge **£31.49**
 Single Sheet Printer Paper **£17.95**
 Z-Fold Printer Paper **£15.95**
 Transparency Paper: Pack of 50 Sheets **£52.95**

STAR PRINTER ACCESSORIES:

Star LC-20 Mono Printer Automatic SheetFeeder **£74.95**

Star LC24-10 Mono Printer 32K Buffer **£67.95**
 Automatic SheetFeeder **£74.95**

Star LC-200 Colour Printer Automatic SheetFeeder **£74.95**

Star LC 24-200 Mono/Colour Printers 32K Printer Buffer **£34.95**
 Automatic SheetFeeder **£74.95**

Star SJ48 Printer Automatic Sheet Feeder **£54.95**
 Ni-Cad Battery **£39.95**

Star XB 24-200 Colour Printer Pull Tractor **£34.95**

Font Cartridges - Styles To Be Announced **£29.95**
 128K Centronics Printer Buffer **£89.95**
 Automatic SheetFeeder **£114.95**
 Dual Bin SheetFeeder **£429.95**

Star XB 24-250 Colour Printer Pull Tractor **£34.95**

Font Cartridges - Styles To Be Announced **£29.95**
 128K Centronics Printer Buffer **£89.95**
 Automatic SheetFeeder **£174.95**
 Dual Bin SheetFeeder **£469.95**



GENUINE CITIZEN & STAR REPLACEMENT PRINTER RIBBONS

PRINTER	PRINTER TYPE	BLACK RIBBON	BLACK RIBBON 'SIX PACK'	COLOUR RIBBON	COLOUR RIBBON 'SIX PACK'
CITIZEN 120D+	BLACK ONLY	£4.95	£24.95	N/A	N/A
CITIZEN 124	BLACK ONLY	£4.95	£24.95	N/A	N/A
CITIZEN SWIFT 9	BLACK/COLOUR	£4.95	£24.95	£16.95	£99.95
SWIFT 24/24E/224	BLACK/COLOUR	£4.95	£24.95	£16.95	£99.95
STAR LC10*/20*	BLACK/COLOUR	£4.50*	£24.95*	£6.90*	£36.50*
STAR LC200	BLACK/COLOUR	£6.95 ZX9	£36.95 ZX9	£12.95 ZX9CL	£69.95 ZX9CL
STAR LC24/200	BLACK/COLOUR	£8.95 Z24	£49.95 Z24	£14.95 X24CL	£74.95 X24CL
STAR XB RANGE	BLACK/COLOUR	£8.95 Z24	£49.95 Z24	£14.95 X24CL	£74.95 X24CL
STAR SJ48 INK CARTRIDGE	BLACK ONLY	Also compatible with Apple Stylewriter and Cannon BJ10E Bubblejet			£15.95ea.

BOOK SHOP

FOR BEGINNERS & EXPERTS ALIKE



AMIGA FOR BEGINNERS - VOL 1 ABACUS BOOKS, £12.95
From unpacking your Amiga to creating your own icons, includes first use of basic and extras disk. NEW revised version covering workbench 1.3 and 2

AMIGA BASIC INSIDE AND OUT - VOL 2 ABACUS BOOKS, £18.95
Definitive step by step guide to programming Amiga's in basic.

AMIGA MACHINE LANGUAGE - VOL 4 ABACUS BOOKS, £14.95
Practical guide to learning 68000 assembler language.

AMIGA DOS INSIDE AND OUT - VOL 8 ABACUS BOOKS, £24.95
Guide to Amiga DOS & CLI. NEW Edition inc. WB 2.0 (includes Free Help Disk)

AMIGA HARDWARE REFERENCE MANUAL-Addison Wesley, £21.95
Written by technical experts at Commodore Amiga Inc, USA... the people who designed your Amiga. Hardware level machine code programming at advanced level. New revision now also includes Kickstart 2.

AMIGA, BEST OF TRICKS & TIPS Vol. 17, £32.95
A complete set of tricks and tips that enable you to do MORE with your Amiga and as simply as possible. (Includes Free Disk)

GETTING THE MOST FROM YOUR AMIGA [without disks], £9.95
From Future Publishing, the producers of Amiga Format Magazine and fully updated for 1992 OR... available with 2 HELP DISKS INCLUDED **£13.95**

WE ALWAYS CARRY LARGE STOCKS OF THE FULL RANGE OF ABACUS & OTHER BOOKS...Phone us for details!

*Credit terms are available (subject to status) for most products: see our ordering panel at the end of this advert for full details

NOW INCLUDING TEN FREE GAMES PACK TOTALLY FREE!

MONITORS & MONITOR TV'S

Harwoods stock a complete range of both Monitors & Monitor TV's to give you your perfect solution to the type of display to buy.

INCLUDES FREE...FREE...FREE... F19 STEALTH FIGHTER



PHILIPS CM8833/II Stereo High Resolution Colour Monitor

The ever popular 14-inch Philips CM 8833 MkII. Its versatility means you not only get excellent colour graphics & text performance with a wide range of personal computers, but when connected to a VCR, you get an amazing 600 pixel TV picture. With the 8833 MkII, Harwoods give you the complete set up, to get you going straight away... Monitor, RGB picture and Stereo Audio Cables, Tailored dust cover, and a full 12 Months on site service warranty.

RGB/AD, TTL, Composite. Video & stereo audio inputs Can be used as a TV with VCR or Tuner Also as a Video Camera display monitor Retractable stand Twin Stereo Speakers Headphone Jack Socket FREE lead for your computer FREE 12 Month on site service warranty.

THE MOST VERSATILE STEREO COLOUR MONITOR AVAILABLE **£249.95**

CBM 1084S STEREO COLOUR MONITOR.

Commodore's Own Stereo High Resolution Colour Monitor with... RGB/AI/TTL, Composite. Video/Audio Inputs Can be used as TV with VCR or tuner. Twin Speakers for stereo output Supplied with cables for A500, CGA PC, IC16-64-128.

£269.95

It's important to remember that most TV Monitors, are still first and foremost televisions, meaning that their average 400 pixel tube display 50% lower resolution than a monitor cannot be guaranteed to display 80 column text clearly without risking eye strain. If choosing a Television Monitor ensure it has the latest 2000 character tube capability, meaning it can handle the Amigas' 80 characters, by 25 line output clearly.

NEW!!! PHILIPS 15" FASTEXT TELETEXT REMOTE CONTROL 60 CHANNEL MONITOR TV. BRAND NEW SUPERB DEFINITION PHILIPS MONITOR TV. IDEAL FOR AMIGA OR CDTV USERS. GIVING FOR THE FIRST TIME TRUE MONITOR QUALITY FROM A FULL FEATURE TELETEXT TV AT AN AFFORDABLE PRICE!!!. JUST LOOK AT THE FEATURES... Direct Scart Connector for Amiga, CDTV, VCR OR SATELLITE RECEIVER RGB/AD, Composite Video & audio inputs FULL TELETEXT FACILITIES (FOR THIS FACILITY EXTERNAL AERIAL SHOULD BE USED) Headphone Jack Socket FULL TWO YEAR GUARANTEE 2000 CHARACTER HIGH DEFINITION FST TUBE SUPPLIED WITH LOOP AERIAL REMOTE CONTROL FREE lead for YOUR computer (IF YOU WOULD LIKE THE MONITOR TV IN OUR PACKS 2, 3, AND POWERPRO, AT NO EXTRA COST, TO REPLACE THE 8833/II, SIMPLY ADVISE US AT THE TIME OF ORDERING)

ONLY... **£259.95**

10 FREE GAMES WITH YOUR TV OR MONITOR WHEN PURCHASED SEPARATELY (ie. These games are already included within Harwoods Amiga Packs 2, 3, & Powerpro...see details on pages 1 & 2 of this advertisement!!!)

AMIGA ACCESSORIES

KCS POWERBOARD IBM PC EMULATOR Allows you to run many popular IBM PC compatible software titles on your Amiga or Amiga A500 Plus Hercules, CGA & Monochrome Video Support, Supports Both 3.5 Inch & 5.25 Inch Diskettes Fits into A501 RAM Slot, 8088 XT Processor, Clock/Calendar Included, Acts As 512K RAM Exp. When In Amiga Mode, Includes MS-DOS 4.01, Shell & GW-BASIC, DOS-Help, & On-Board Memory Supports A590 Hard Drive, Mouse Driver Software Included. WHEN ORDERING PLEASE SPECIFY WHETHER YOUR AMIGA IS A 1.3 OR PLUS VERSION. **£219.95**

KCS POWERBOARD AS ABOVE BUT WITHOUT: MS-Dos 4.01, GW-Basic, Shell, £189.95

POWER MONO SCANNER COMPLETE WITH POWER SCAN SOFTWARE 100dpi TO 400dpi. Supports up to 64 grey shades. Throughport for printer etc. Supplied with Power Scan software, allows full screen image editing, interlace mode on or off, edit true grey scale and even colour images. **£99.95**

SUPRAMEM RX 500 (2Mb. to 8Mb. RAM Expansion) The RAM expansion giving massive memory WITHOUT dismantling your Amiga, thus avoiding the possibility of invalidating your warranty. Easily connects to sidecar with bus 'pass-through' for HD's etc. 2Mb. RAM Version **£199.95** 4Mb. RAM Version **£329.95** 8Mb. RAM Version **£549.95**

NAKSHA MICROSWITCHED MOUSE **£24.95**
HIGH QUALITY OPTICAL MOUSE **£32.95**

COMPETITION PRO JOYSTICK 5000 Black **£7.95**
ZIPSTICK JOYSTICK **£12.95**

COMPETITION PRO STAR JOYSTICK **£14.95**
The ONLY joystick to obtain a 100% rating from a magazine review!

3.5" DISK HEAD CLEANER **£2.99**

BLANK DISKS with labels
10 Genuine SONY 3.5" branded **Only £9.95**
50 Genuine SONY 3.5" branded **Only £39.95**



10 Unbranded with library case 3.5" certified **Only £7.95**
200 Unbranded 3.5" certified **Only £84.95**

MIRACLE PIANO TEACHING SYSTEM - Music Keyboard to connect to your Amiga **£299.95**

Miracle is the first Piano to teach you how to play it. Whether you want help finding Middle C, or want to learn how to play Mozart, Miracles stunning Amiga Software and Midi Keyboard turns learning into FUN. Study Classical, Rock and even Jazz.

128 Built in Sounds Full sized Touch Sensitive keyboard keys Stereo Sound

Get even more from your Amiga Miracle even gives you a recording studio

Versions for other computers available too, please ask for details

POSSO STORAGE BOXES **£19.95**
150 piece stackable 3.5" disk storage boxes

BANX STORAGE BOXES **£11.95**
80 piece lockable 3.5" disk storage boxes

MANY MANY MORE ACCESSORIES TOO NUMEROUS TO LIST ARE ALWAYS AVAILABLE FROM GORDON HARWOODS. If it's not listed just phone us and ask!!!

Easy Ordering

Before you choose from whom to purchase, please phone us. We are always happy to discuss your requirements, and answer any queries you may have...

ORDER BY PHONE: Phone our Order Hotline with your Access, Visa, Mastercard, Switch or Lombard Creditcharge Card quoting number & expiry date (Dixons, Currys, NASCR and other 'store' cards are Lombard Creditcharge and are accepted by us).

ORDER BY POST: Make cheques, bankers building society drafts or postal orders payable to GORDON HARWOOD COMPUTERS. (Personal/business cheques take 7 days to clear from day of receipt whereupon your order will be despatched). Please send Name, Address, and most importantly if possible, a Daytime Telephone Number along with your order requirements. Please check you are ordering from one of our latest advertisements before posting (phone if you require confirmation). Please remember that for example many September publications appear during August, therefore prices you see may have changed (either up or down).

FREE POSTAL DELIVERY: FREE within 14 working days, UK Mainland only. OR **COURIER SERVICE:** Add £5.95 per major item for next working day delivery, UK Mainland most regions.

EXPORT ORDERS: Most items are available at TAX FREE PRICES to non UK residents when visiting /export shipment. Please contact us for ordering information.

REMEMBER AFTER YOU'VE BOUGHT FROM HARWOODS, WE'LL STILL BE HERE...

TECHNICAL SUPPORT: You will be given our Exclusive Technical Support Phone Number to call should you require any help or advice on any aspect of the system you have purchased.

12 MONTH WARRANTY: Items proving faulty within 30 days of purchase are replaced with NEW UNITS unless otherwise stated. For the whole guarantee period, warranty service will be completely FREE OF CHARGE.

COLLECTION FACILITY: Any computer, monitor or printer requiring warranty service can be collected from your home FREE OF CHARGE during the guarantee period (UK Mainland only) and a FAST turnaround is GUARANTEED by our OWN ENGINEERS!

FULL TESTING PROCEDURE: All computers are tested prior to despatch, and all items are supplied with mains plug and leads as required - just connect up and use straight away.

REMEMBER WE'RE NOT JUST ANOTHER MAIL ORDER COMPANY...

All listed prices are what YOU PAY, and there are NO HIDDEN EXTRAS. VAT and postage are included, and prices are correct at time of going to press (Pack details may vary from time to time). Offers are subject to availability and to being the latest advertised packs and prices. Our offers are NOT supplied on a trial basis. E&OE.

FINANCE FACILITIES... tailored to suit your needs. Written details on request.

Gordon Harwood Computers offer facilities to purchase using our budget account scheme. APR 36.8% (Variable). Available to most adults of eighteen years or over, subject to status. Simply phone or write and we will send you written details along with an application form. Applications, required in advance, available to full time U.K. mainland residents and overseas British forces personnel. Showroom visitors, please ask for details of our in-store "Instant Account". Written quotations on request.

If you are already the holder of a Lombard Credit Charge Card you can use this to purchase from us (subject to your personal card limit)

VISIT OUR SPACIOUS SHOWROOM: Please pay us a visit where our full range of advertised products, at the SAME COMPETITIVE PRICES, & MORE, is on sale. 'ALL UNDER ONE ROOF', in pleasant surroundings at our purpose built showroom (See note below map). There's plenty of FREE parking close by.

OPENING TIMES: 9.00 until 5.00 Monday to Saturday 9.00 until 1.00 Wednesday. Closed on Sundays

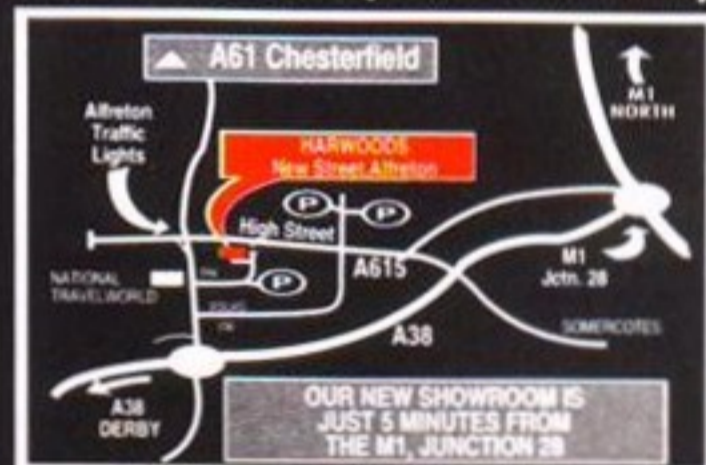

GORDON HARWOOD HARWOOD HARWOOD Computers



GORDON HARWOOD COMPUTERS DEPARTMENT amf /G4, NEW STREET, ALFRETON, DERBYSHIRE, DE5 7BP TEL: 0773 836781 FAX: 0773 831040

Special Offers Special Offers Special Offers

SAVE £££s SAVE £££s SAVE £££s SAVE £££s

PUBLIC APOLOGY

WE WOULD LIKE TO TAKE THIS OPPORTUNITY OF APOLOGISING TO YOUR CURRENT RIBBON SUPPLIER **Re-inK** the product taking the ribbon world by storm. To see how **Re-inK** can save you £££'s just look at some of the benefits you can enjoy by using **Re-inK**. DO NOT DELAY - PLACE YOUR ORDER TODAY.

- ★ **FACT** **Re-inK** gives cleaner, blacker, print than your original ribbon
- ★ **FACT** **Re-inK's** special blend of oils is proven to extend printhead life by up to 500%
- ★ **FACT** **Re-inK** is extremely simple and easy to use
- ★ **FACT** **Re-inK** does not contain harmful CFC's or fluorocarbons of any kind
- ★ **FACT** **Re-inK** works with any fabric printer ribbon
- ★ **FACT** **Re-inK** actively helps protect our precious environment

PRODUCT STATEMENT





You can help put an end to this environmental waste and save some money at the same time thanks to **Re-inK**, a revolutionary new spray which brings new life to exhausted fabric printer ribbons.

Re-inK is cost effective and simple to use. Simply open up your plastic ribbon cartridge, spray a few squirts of **Re-inK's** special ink and lubricant formula and your ribbon is as good as new - sometimes even better!

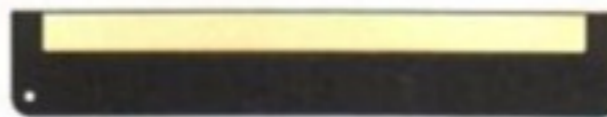
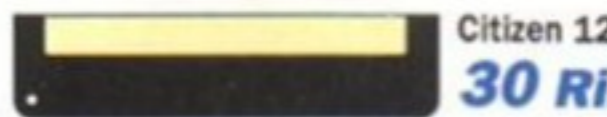

Re-inK is on average equal to:-

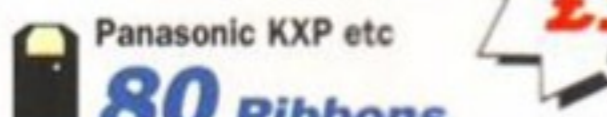
-  Epson LQ1000 etc **15 Ribbons**
 -  Citizen 120D etc **30 Ribbons**
 -  Star LC24-10 etc **40 Ribbons**
 -  Star LC10 etc **50 Ribbons**
 -  Panasonic KXP etc **80 Ribbons**
- Also works on Typewriter Ribbons, Calculator Rolls, Stamp Pads etc
- Re-inK ONLY**
£12.95
inc VAT/P&P

DEALERS REQUIRED

DEALERS REQUIRED

HOTLINE
0689 861400

MD Office Supplies

18 Crescent Way, Orpington, Kent BR6 9LS.

HOTLINE
0689 861400

SAVE £££s SAVE £££s SAVE £££s SAVE £££s

DISKETTES

Specialists for over 3 years supplying Education, Government, home user, quality, reliability, value for money.
YOU SIMPLY CANNOT BUY BETTER

3.5 **DOUBLE SIDED**
DOUBLE DENSITY

100% CERTIFIED & GUARANTEED

- 50 DSDD 3.5 Plus deluxe storage box only.....£29.95
- 100 DSDD 3.5 Plus deluxe storage box only.....£44.95

THIS MONTHS SPECIAL

200 DSDD 3.5 Plus 2 deluxe storage boxes only ...£74.95

MD Office Supplies

18 Crescent Way, Orpington, Kent BR6 9LS Tel: 0689 861400



Educational & Government orders welcome



ALL PRICES INCLUDE P&P

(Subject to a minimum order of £20.00 where £2.95 P&P is incurred except Re-inK).

BANX STACKABLE BOXES



- Features Include: Both stack horizontally and vertically
- | | |
|---|--|
| 90 Capacity 3.5
Very high quality manufacture
Anti-static
Protective lock
Colour coded dividers
only £9.95 | 180 Capacity 5.25 or 130 3.5
Beautiful strong design
Anti-static
Protective lock
Colour coded dividers
Smooth draw operation
only £16.95 |
|---|--|

THIS MONTHS MAD, MAD OFFERS

- | | |
|--|---|
| OFFER 1
100 DSDD 3.5" Diskettes plus
Banx stackable Box
ONLY £47.50 | OFFER 2
200 DSDD 3.5" Diskettes plus
2 x Banx stackable Boxes
£85.00 |
|--|---|

SAMPLERS BY THE BUCKETLOAD...

For some reason, there seems to be a new sampler under development somewhere in the world almost every week. This month sees the arrival of a whole new set: here's a quick look at the features you can expect.

BEAT STUDIO

AROUND £30 CITY BEAT (PANDAAL)
0234 843355



The nice thing about this small and tidy package is that it comes with all the various leads that you need to connect up to your hi-fi or any other sound source with phono plugs, so you can get sampling straightaway. It samples in full stereo and it looks like being a good little piece of software, with complete loop editing to make

long tracks and also a MIDI-compatible sequencer built in to make complete songs with. Should be good.

TECHNOSOUND TURBO

AROUND £30 NEW DIMENSIONS
0291 690933



This package has exactly the same specifications as the *City Beat* sampler for one particularly good reason: as far as we are aware, both have been developed in parallel by the same team, so it's just a question of who you buy it from. *TechnoSound* has long come highly recommended by us, combining a surprisingly good bit of hardware with some very decent software to give easily the best value in entry-level sampling. The new version now also includes audio leads and MIDI song sequencer.

MEGAMIX MASTER

PRICE N/A ROMBO 0506 466601

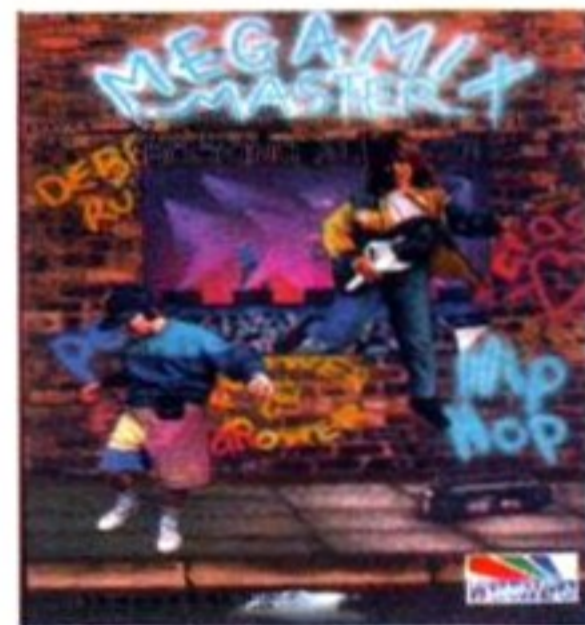

Here's a product that's joining in at the low-cost, high-specification end of the market. This is the first foray into sound for the company that is actually best known for their remarkable video digitisers. *Megamix Master* would appear from first impressions to score very highly on ease of use, with friendly and colourful graphics, and it can do real-time effects processing to give effects like Echo: home karaoke here we come!

DIGITAL SOUND STUDIO (DSS8)

£59.95 GVP VIA SILICA 081-309 1111



Slightly more expensive, this one, and we have to admit that first impressions give us a bit of a problem. The sampling hardware contained in the package we received bore absolutely no resemblance to the one pictured on the pack: it has no LEDs for level monitoring and no potentiometers to set record levels on the stereo channels. What's going on here? These gripes apart, it looks like it could be quite a decent little package, with

real-time effects and its own sample sequencer that even saves in Sonix format. We'll see how it does...

Coming Contraptions

With the traditional spring lull in the computer industry, there's been a slight drop-off in the amount of new products coming out for the Amiga, but there's still plenty of exciting developments afoot...

HOTLINKS EDITIONS FOR PAGESTREAM

PRICE N/A SOFT LOGIK VIA SILICA 081-309 1111

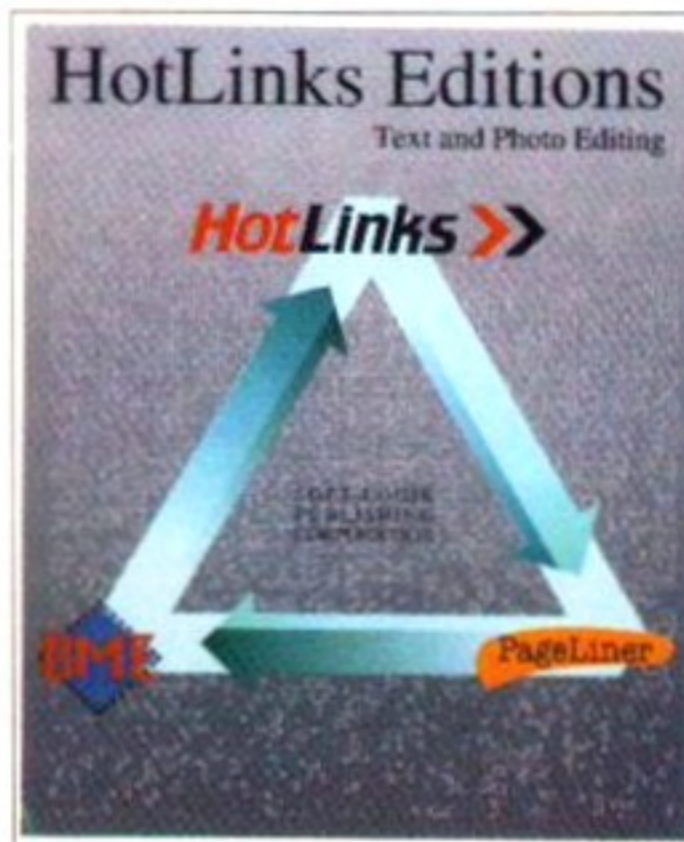

Continuing with their slogan of "We give you the tools to dream", Soft Logik have come up with a set of support programs for their top DTP package *PageStream*. With the latest version of the package, which we reviewed last month, we reckon *PageStream* has finally come out on top of the DTP heap. One of its major features is a 'publish and subscribe' system called Hotlinks, and these applications are all intended for use with the *Hotlinks* system.

The idea is that even as a text or picture file is modified, the new version can be updated in all applications that are sharing the same file. Put in simple terms, this means that you waste no time reimporting a touched-up picture or a spell-checked text file into a DTP page: the DTP file will be updated automatically to receive the new changes.

The Editions contains a *Hotlinks* system with a full user guide as well as two programs designed for file editing in conjunction with *PageStream*: a picture editor called *BME* (*BitMap Editor*) and a text editor by the name of *PageLiner*.

BME is primarily intended for touch-up work, though it can also be used for compositing. It will load an enormous range of different picture formats, including up to 30-bit RGB colour images and 32-bit CMYK separations. Sizes can be up to 32,768 pixels square, which is ideal for scans. As well as limited paint tools the program features cut, copy and paste tools and has a transparency option on paste. You can paint from one area onto another, which makes touch-up much easier. The program displays in 16 greyscales, though you can actually pick out and display a single colour from your image to keep a check on it.

PageLiner is a standard text editor, featuring all the usual word processor specifications such as cut, copy, paste, insert, spell-checking with a user-definable dictionary and so on. It also allows you to set text style tags for use in *PageStream* pages, it features a real-time word count, and it lets you display 'invisibles' such as tabs and returns, which can be very useful.

AMINET NETWORK

£19.99 PRECISION DISTRIBUTION 0753 557888



Networking a set of computers can be a difficult task, and it's not too common for a large establishment to be using numbers of Amigas together, so networks have never really taken off for the Amiga. Just arrived, however, is a new solution for networking which certainly looks simple enough to use in even a small network of Amigas.

All you have to do is get one *AmiNET* pack for each computer, and you can connect (so the package claims) up to 200 Amigas in a simple ring network. Each package consists of a dongle that plugs into the serial port, as well as two plugs and two leads of decent length, one for 'in' and one for 'out'. After the connections are made, the software must be installed on the machines and you're up and talking.

It all sounds simple enough and, if it proves to be that simple in use, then it could be an ideal solution to networking for small multi-user establishments like schools. Certainly the printer-sharing facility that a network would provide could be handy.

It all sounds simple enough and, if it proves to be that simple in use, then it could be an ideal solution to networking for small multi-user establishments like schools. Certainly the printer-sharing facility that a network would provide could be handy.

ART DEPT PROFESSIONAL 2

£229.95 ASDG VIA SILICA 081-309 1111

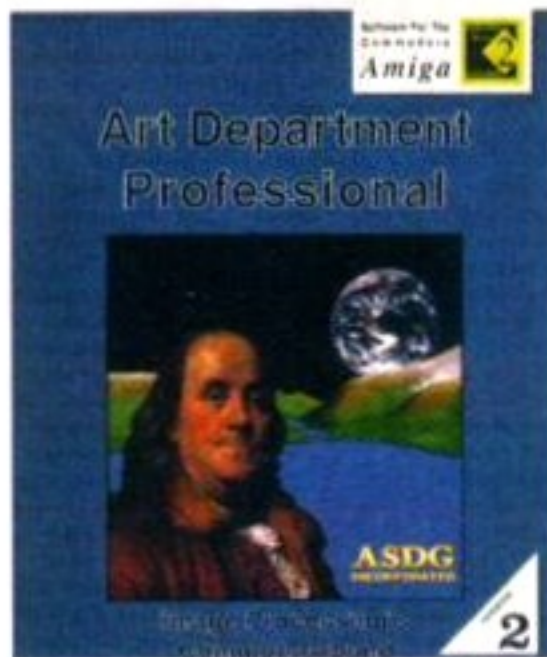

If you're serious about your graphics, then this has to be the one you've been waiting for. The *Art Department* in its *Professional* edition is already established as a top package for transferring files between different graphics formats and for high-standard image processing.

The big thing about the new version is the addition of the JPEG-standard image-compression system. This can reduce 24-bit image files to as little as 40K in size, meaning that masses of expensive disk space could be saved. Beyond that, the spec remains pretty much the same. We'll be taking a close look at this leading package next month.

In the meantime, just in case you're not familiar with the system, here's a brief run-down of what it does. It uses a modular system of file loaders and savers, which means you can add on an extra module to cover any file types from any popular computer format you particularly want to use. The professional version comes as standard with modules for PCX, GIF, DigiView, Sculpt and several more as well as saving in Postscript and, of course, load and save in full IFF and JPEG formats.

In between loading and saving, the program treats all data as either colour at 24-bit or greys at 8-bit resolution, so you've got the maximum possible quality in all operations. A loaded picture can have any number of image-processing operations performed as well as having text added. Finally images can be printed out on any Amiga Preferences printer so as to give full 24-bit colour. And that's just a brief description...

DAATASCAN PROFESSIONAL GS

EVARIES PANDAAL 0234 843355



For anyone who already owns a PanDAAL DaataScan hand scanner, this is just a software upgrade. If you don't already own the hardware/software combination, then the updates to this scanning package have to make it worth a look.

The hardware is a high-quality scanning head, which you must draw across the image you wish to scan. Four different resolution modes can be set as well as a number of tweaks to enable good reproduction. The scanner plugs into an interface which in

turn plugs on the back of the Amiga. The whole package can be bought for £109, but check for latest prices which may drop. A version is also available with a port sharer for the parallel port into which the interface plugs, costing £124.95.

The newest version of the software is version 2.02, which owners of the hardware can obtain for a £15 upgrade fee. It has been highly rewritten from the original slightly temperamental package supplied with the old DaataScans. The big news on the latest version is the addition of a greyscale mode, which converts half-tones to full greyscales. This makes a great deal of difference when using scanned images for computer-art type purposes. We'll be showing you the results in a review next issue.

DIGIVIEW MEDIA STATION

£179.95 NEWTEK VIA SILICA 081-309 1111



A high-value pack combining two of the packages which made NewTek one of the big names in Amiga software along with a third-party complimentary animation system. This has been on sale for a while as a package but has been widely ignored by the press, partly because there's not actually anything new in there and partly because NewTek are now concentrating their attentions on the infamous *Video Toaster* hardware.

The keystone of the package is *DigiView*, the top-class HAM digitising package: the other two packages are really simply freebies thrown in with this one. *DigiView* is the most popular and effective three-pass colour digitising system there is, building up separate red, green and blue parts of an image using the output from a mono video camera filtered through coloured plastic. *DigiView* has long been considered the standard for this type of digitising, with its excellent results, the innovative hi-res 'Dynamic' HAM mode and even pseudo-True Colour 21-bit output. It's still a winner.

Of the other two packages the first is *DigiPaint 3*, the HAM-only paint program. Three years ago there was nothing to choose between this and its rival *Photon Paint 2* if you wanted to paint with all 4,096 Amiga colours, and even now *DigiPaint* has some unique features that make it worth owning even if you already have a HAM package.

Elan Performer makes up the trio. This is an animation sequencing package that has a rather weird aim: it's intended for actual live performance use, so animations, sounds and individual pictures can be assigned to individual keys on the keyboard and then cued in real time. Apart from that it's quite a sophisticated system for developing presentations on the Amiga.

'Serious' reviews

This is the section of the magazine dedicated to bringing you honest and intelligent reviews of the latest 'serious' releases in hardware and software.

From expansions such as extra memory and hard drives through to useful, practical utilities to the latest in 'productivity' (DTP, databases) and 'creativity' (paint, animation, 3D, digitisers and music) software, it's all in here.

Two years running, *Amiga Format* has been voted by computer retailers as the magazine that they most trust when they're deciding what to stock, so you can see that we're the people best placed to advise you on what to buy. With our expert knowledge, we know what's the best program to date for any particular kind of job, and we'll see how anything new stacks up against the best in the business.

Contents

Get ready for a 'seriously' creative section to chill out to. You'll find some Format Golds taking it easy in there too.

SUPERJAM 122

Want to create a song in a certain style from separate elements? That's what Blue Ribbon's music composer system lets you do!

XOR..... 127

Can Dr-T's generic patch editor-and-librarian system help you get the most from your synthesiser system?

V-LAB 130

Video digitising without the need for an RGB splitter, sound too good to be true? German technology paves the way.

EXPERT DRAW 134

One of the Amiga's great uncharted territories, structured drawing welcomes a British version of this German program.

IMAGINE 2..... 138

The latest release of Impulse's True-Colour 3D package has a high standard to maintain. Can it cut the mustard?

TV PAINT..... 142

24-bit painting on the Amiga comes bang up to date with the Amiga Centre Scotland's latest update of TVPaint.

VISTA PRO 2 150

Virtual Reality Labs' latest landscape generator comes under close scrutiny, along with its supplementary programs.

How the Ratings System works

SPEED (marked out of 5) ●●●●●

Tremendously important for both hardware and software: there's nothing more annoying than waiting. A purely intuitive judgement.

DOCUMENTATION (out of 5) ●●●●●

Although there are some packages that are so simple no manual is needed, complex items benefit hugely from a good explanation.

ACCESSIBILITY (out of 5) ●●●●●

The target for all good software should be powerful but simple: this rating assesses how easy it is to get to grips with the item.

FEATURES (out of 5) ●●●●●

Does it do what you want it to do? How well does it do it? And does it also do lots of other things that you'd never have thought of?

VALUE (out of 5) ●●●●●

A pretty important rating, this one: if a package does everything you could wish for, it's no use to you unless you can afford to buy it.



The Verdict, our at-a-glance overall rating, is a percentage: it's based on sheer quality but with the price taken into account, so that you know what kind of a deal you get.

FIRST CHOICE
1
COMPUTERS

FIRST CHOICE

LEEDS

TEL: 0532 637988
FAX: 0532 637689

OPENING HOURS

OPEN MON - SAT 9.30AM-5.30PM
SUNDAY OPENING 11.00AM-3.00PM
THURSDAY NIGHT LATE 9.30AM-7.30PM

WEST YORKSHIRES PREMIERE AMIGA AND ATARI COMPUTER STORE

AUTHORISED DEALERS FOR STAR, CITIZEN,
COMMODORE, ACORN, ROMBO & PHOENIX



THE NEW AMIGA A500 PLUS CARTOON CLASSICS PACK

Now complete with:

- * One Mb of chip RAM expandible to 10 Mb of RAM in total
- * The new Kickstart 2.04
- * Workbench 2.04
- * Built in battery backed real time clock
- * New improved user friendly manuals

This pack also comes with Lemmings, (the only game ever to get a 100% rating!) The Simpsons, Captain Planet and Deluxe Paint 3 the incredible paint and animation package plus mouse and modulator

now only £334.99!!
or £369.99 for the 2Mb version

THE NEW AMIGA 600 SERIES

The new 600 series comes in two specifications, the standard A600 and the A600HD which has a built in 20Mb hard drive. Features include 1Mb RAM, 3.5" internal floppy drive, IDE controller, smaller footprint, and new smartcard cartridge port to accept faster loading cartridge software plus software bundle.

Standard AMIGA A600

only £369.99

or AMIGA A600HD with 20Mb hard drive

only £469.99

Larger Hard Drive
Configurations Available....£POA

MONITORS

All our monitors are UK spec

All monitors come complete
with a free Amiga lead

WARNING: Before you purchase a monitor make sure it has a full UK specification. You might be buying what you think is a similar monitor at a lower price but it is likely to be a "GREY" import. These monitors do not comply with British safety standards and are not covered by an official warranty

Protar Stereo colour monitor

This monitor uses the same tube as the Philips 8833 MK2 and has a similar specification. The Protar comes with a full 12 month replacement guarantee. This must be the best value medium res. monitor on the market. Amiga cable included. Tilt and swivel stand only £11.99 when purchased with this monitor. Cover only £5.99

only £195.99 UK Spec.

Commodore 1085 SDI Stereo Colour monitor

The perfect complement to your Amiga system. This Colour stereo monitor features .51 dot pitch resolution and green screen facility. Amiga cable included. Tilt and swivel stand only £11.99 when purchased with this monitor Cover for monitor only £5.99

only £219.99 UK Spec.

Philips CM8833 MK2 stereo colour monitor

Colour stereo monitor. 600*285 line resolution, green screen facility, one years on site maintenance, cable for Amiga included. Tilt and swivel stand only £11.99 when purchased with monitor. Cover only £5.99

only £234.99 UK Spec.
with F19 Flight Simulator

Philips Brilliance SVGA Colour monitor with overscan facility

The Brilliance monitor has a high quality Super VGA resolution ideal for making your AMIGA into a professional system. Includes overscan facility, .28 dot pitch, and tilt/swivel stand. Monitor cover only £5.99 if purchased at the same time

1500 VERSION £399.99

with Flicker Free Video card

A500 VERSION £499.99

Goldstar remote control TV/monitor

superior to a standard TV set with full remote control

now only £179.99

Commodore 1960 multisync
only £436.99

FIRST CHOICE PACK with Cruiser Black Joystick, 3 games, dust cover, mouse mat and 10 blank discs **ONLY £29.99!!**

THE NEW AMIGA 1500 & 2000 PLUS

The New AMIGA 2000 Plus Base pack

now complete with the latest 2.04 Kickstart chip and Workbench 2.04 !!

The 2000 Base pack is the ideal upgrade machine for those wanting to upgrade from their present Amiga 500

only £519.99

Amiga 1500 Plus Business & Entertainment Software pack

The same spec. as the base pack but with Deluxe Paint 3, Platinum Works (the best integrated package available for the Amiga), Home Accounts, Puzznic, Elf, Toki plus the latest Amiga Format Tips book (2.04 compatible) and Joystick.

only £549.99 or £759.99

with 1085SDI colour monitor (UK Spec.)

THE NEW AMIGA 1500/2000 & 500 DELUXE SERIES

The AMIGA 500 Deluxe

is an updated version of the A500 Plus with the Phoenix ROM sharer and 1.3 chip because some older software will not run on the A500 Plus. The A500 Deluxe has been developed so you can choose to run either Kickstart 1.3 or 2.04 making incompatibility problems a thing of the past! The Deluxe also Comes complete with the Cartoon Classics software pack.

only £409.99 or £444.99
for the 2 Mb version

The Amiga 1500/2000 Deluxe is an advanced version of the standard AMIGA 1500 Plus

incorporating the famous Phoenix ROM sharer and 1.3 Kickstart ROM chip. As with the A500 Deluxe, this enables you to switch between the old and new operating system to accommodate older software that can only run on the 1.3 operating system

only £579.99 for A2000 base pack or
£609.99 for the 1500 software pack version

GVP HARD DRIVES & ACCELERATORS

AMIGA 1500/2000 Hard Drives

Impact Series II HC8+ Control card only.....	£134.99
Impact Series II HC8+ with 52Mb Hard Drive.....	£279.99
Impact Series II HC8+ with 120Mb Hard Drive.....	£419.99
Impact Series II HC8+ with 240Mb Hard drive.....	£659.99
Impact Series II HC8+ with 420Mb Hard drive.....	£1219.99

AMIGA 1500/2000 Accelerator Cards

G-Force 030-25MHz with 1Mb 32 bit RAM.....	£559.99
G-Force 030-40MHz with 4Mb 32 bit RAM.....	£899.99
G-Force 030-50MHz with 4Mb 32 bit RAM.....	£1269.99
G-Force 040-28MHz with 2Mb 32 bit RAM.....	£1699.99

AMIGA A500 HARD DRIVES

GVP Series II HD8+ 52Mb.....	£359.99
GVP Series II HD8+ 105Mb.....	£469.99
GVP Series II HD8+ 240Mb.....	£749.99

GVP Combo Accelerator Series for the AMIGA A500

A530 Combi 40MHz with 52Mb Hard Drive.....	£699.99
A530 Combo 40MHz with 120Mb Hard Drive.....	£849.99
A530 Combo 40MHz with 240Mb Hard Drive.....	£1039.99
68882 Co-Processor for A530.....	£234.99

GVP memory RAM modules

Series II RAM8 RAMcard for AMIGA 1500/2000 with 2Mb.....	£149.99
32 bit 60ns 1Mb SIMM for Accelerator cards.....	£64.99
32 bit 60ns 4Mb SIMM for Accelerator cards.....	£179.99

FIRST CHOICE (LEEDS) TEL: 0532 637988

FAX: 0532 637689



Free Delivery on all products!!!

CDTV

Commodore Dynamic Total Vision

Complete with Hutchinsons Encyclopedia, Lemmings and Welcome CD disk, CDTV is a powerful media for both entertainment and education. Capable of handling up to 540 Mb of data, whole encyclopedias can be stored on just one compact disc. The CDTV is also a high quality audio CD player. We also stock a large range of CDTV software all at discount prices

**now only
£449.99 UK Spec.**

New CD Rom for the Amiga A500

The add-on that every one has been waiting for. This high quality CD ROM turns your amiga into a CDTV

only £279.99

New CDTV key-board

Effectively transforms your CDTV into an Amiga so you can get even more out of CDTV. With the aid of a standard 3.5" disc drive the CDTV will take most of the normal Amiga software from word processing to entertainment

only £49.99

New CDTV Trackerball

complete with 2 joystick ports, this is a must for CDTV owners

only £74.99

FIRST CHOICE PACK

Take the headache out of buying a computer with our ever popular FIRST CHOICE Pack. All the essentials required for the first time buyer. Ideal for any Amiga and great value too!

Comprises:

- * Top quality microswitched Powerplay Cruiser joystick
 - * Mouse Mat
 - * Dust Cover
 - * 10 Blank Disks
 - * Plus 3 Extra games!!
- only £29.99**

STAR PRINTERS

All Star printers inc ribbons, free std printer cable and 12 month guarantee

The Star LC20

Replacing the famous LC10, the LC20 is faster at 180cps draft and 45 cps NLQ. It's also quieter. The front panel now has push button operation replacing the old LC10 membrane panel. Other spec is similar to LC10.

now only £139.99!!

New Star LC24-20

24 pin quality at the price of many 9 pins. 210cps draft, 604cps in LQ, 16k buffer expandable to 48k, 10 resident fonts, LCD front display, Auto emulation selection

only £199.99

Star XB24-200 Colour

The choice of many professional organisations, this printer comes with one year on-site maintenance. 332 cps draft, 100 cps LQ, 29k buffer exp to 189k, 4 super LQ fonts and 14 LQ fonts

now only £379.99

Star LC24-200

Mono and colour. 222 cps draft and 67 cps LQ. 10 resident fonts. A4 Landscape printing

**only £229.99 mono
or £289.99 colour**

Star LC200

Colour 9 pin printer with 8 resident fonts and a high speed of 225cps draft and 45 cps in NLQ. A4 Landscape printing

now only £199.99

Star printer accessories : Dust covers from £4.99. Printer stand just £7.99 when purchasing printer. Mono ribbons from only £3.69

CITIZEN PRINTERS

All Citizen printers inc. free printer cable and come with a full 2 year warranty!

The Citizen Swift 9 Colour

Unbeatable value colour printer. 4 resident fonts, 192 cps draft and 48 cps in NLQ. Highly recommended. This printer is also available in a wide carriage (136 column) version

**only £194.99 (80 col)
or £314.99 (136 col)**

The New Citizen 224

A replacement for the famous 124D, the 224 now comes with the option to upgrade to a high resolution colour printer. If you want 24 pin quality, you want to print in colour if necessary and you don't want to spend a fortune, the new 224 is an ideal solution. Using the same technology as the Swift 24, the 224 is basically a cut down version. 192 cpi draft and 64 cpi letter quality with 3 built in fonts.

**only £214.99 (mono)
or £244.99 (colour)**

The New Citizen Swift 24e and 24x (What Micro Best Buy)

The best budget 24 pin printer has just got better!

This must be the best 24 pin colour printer for less than £300. 8k buffer expandable to 40k, 216 cps draft, 72 cps LQ and multilingual too!

**only £274.99 (80 col)
or £414.99 (136 col)**

Citizen printer accessories : Mono ribbons only £4.99, Printer stands £24.99, auto sheet feeders £85.00, semi auto sheet feeders only £15.00

THE STAR SJ48 BUBBLEJET

With Epson LQ and IBM Proprinter emulation. The SJ48 is a revolution in printer technology. The quality is almost as good as an expensive laser printer yet costs less than many 24 pin printers. Portable in size, very quiet, and faster than most dot matrix printers at 100 cps in LQ. Printer cable included

**only £229.99
Auto sheetfeeder £52.99**

THE NEW EPSON 4100

With 512k of RAM as standard from First Choice, expandable to 6 meg, 6 pages per minute, HP2, FX, LQ, GQ compatible. 150 autosheet feeder, 12 months on-site maintenance and printer cable.

**only £719.99
Toner cartridge £59.99**

HEWLETT PACKARD PRINTERS

The HP Deskjet 500 printer allows you to create laser jet quality without the cost. With 100 page auto sheet feeder, printer cable, 3 page / minute speed and

**3 year UK warranty
only £339.99**

The HP Deskjet 500C
The famous deskjet 500 is now available as a colour printer. With this printer you can get stunning colour output at laser quality

now only £569.99

PHOENIX A500 PLUS RAM MODULES

We stock the best name in A500 Plus RAM expansions. These high quality RAM modules will take your A500 Plus up to 2 Mb of chip RAM without invalidating your warranty.

Unpopulated.....only £17.99

Populated to 512K...only £29.99

Populated to 1 Mb....only £39.99

PHOENIX ROM SHARER

Because some older software will not run on the new 2.04 operating system Phoenix have designed a high quality ROM sharer. Recognised as being the best on the market, this ROM sharer features a flexible ribbon connection so that it can be positioned anywhere within your A500 Plus. Keyboard switchable sharer now available!

Don't be fooled by cheap low quality alternatives to Phoenix, treat your Amiga to the best!!

now only £19.99

or £29.99 for keyboard switchable version

Kickstart 1.3 only £29.99 or Kickstart 2.04 only £42.99

DISK DRIVES

New Roclite 3.5"

The new super slim Roclite has recently received the best review for disk drives in Amiga Format

only £59.99

Cumana 3.5"

1 meg external drive. The best name in disc drives now at a super low price. Still the most reliable.

only £57.99

All Phoenix products come complete with a full 2 year replacement warranty

SUPRA MODEMS

Supra 2400

Get on line with this incredible value fast modem from Supra with auto dial and auto receive. 2400 baud Hayes compatible, V22 BIS. Includes free modem cable and comms software!!

only £84.99

Supra 2400 Plus (9600 Baud)

Even faster than the standard 2400 modem from Supra with auto dial and auto receive. 9600 baud Hayes compatible. V42 BIS and auto adjusting facility to maximise transmission speeds. Includes free modem cable and comms software!!

only £129.99

EMULATORS

The New GVP PC-286 16MHz emulator module

plugs into an internal mini slot on the GVP Series II HD8 + or GVP A530 hard disc drives

only £239.99

VORTEX

AT Once Plus

emulator turns your Amiga into an IBM AT compatible. The AT-Once Plus can be fitted to either the AMIGA 1500/2000 or the A500. now with 16 Mhz clock speed!

only £214.99

KCS Power board

Regarded as one of the best emulators on the market, this emulator fits easily into the trap door and also acts as a RAM upgrade. Highly recommended.

only £184.99

Add £15.00 for MS-DOS 4.01
A500 Plus compatible

KCS Amiga

1500/2000 adaptor

only £59.99

THE COMPLETE COLOUR SOLUTION

As official dealers for Rombo, we are able to offer this excellent package at a great price. The complete colour solution comes with RGB splitter, Vidi Amiga, Vidi Chrome, power supply and Photon Paint.

now only £99.99

VIDI AMIGA

High quality digitizing, Inc Vidi chrome colourising software

now only £64.99

RGB SPLITTER

Enables you to Colour Digitise in a second. Replaces red green blue filter set. Can be used with Digi view or Rombo products

now only £49.99

TAKE 2

Designed to be used in with a digitiser or as a stand alone program, this is latest animation package for the Amiga from Rombo. Features include load and save from D. Paint animations and IFF files. Supports HAM graphics.

only £69.99

MEGAMIX MASTER

This is a low cost 8 bit, high spec. sampler that plugs into your printer port. Special effects include echo that can be added in real time, fully multitasking and easy to use.

only £29.99

THE NEW MICROBOTICS ACCELERATOR BOARDS

The VXL is an advanced 68030 accelerator for the Amiga 500/1500/2000 with space for an optional co-processor (CP)

VXL30 25Mhz EC.....only £239.99

VXL 30 40Mhz EC.....only £369.99

68881 co-pro for above....only £79.99

The VXL accelerator boards can also accept 32 bit RAM to optimise performance. The superfast 32 bit RAM comes as a 2 MB or 8 Mb daughter board for the VXL.

2 Mb of 32 Bit RAM (60ns)...only £214.99

8 Mb of 32 Bit RAM (60ns)...only £419.99

PANDAAL HAND SCANNER

On test this scanner has proved to be the easiest and most effective scanner that we have used to date having compared it to most of the other major hand scanners on the market. We are able to offer this high quality scanner at a fraction of the normal cost. Complete with the latest improved version of Daata-scan software this scanner is able to pick out text and graphics at up to 400 d.p.i in real time. Daata-scan enables you to easily manipulate the image. Scans in real time up to 64 grey scales. Ideal for desk top publishing and presentation.

SPECIAL OFFER now only £104.99 or £119.99 with 2 way parallel switcher box

SOFTWARE

FINAL COPY new version 1.2!!

Now faster and easier to use, this superb word publisher from the writers of PenPal. With built in outline fonts for top quality output, full graphics import capability (IFF and HAM). Features include Thesaurus, spelling checker and detector, automatic hyphenation, insert date, time, and page number, scale graphics to any size, crop graphics, multiple columns layout, magnified and reduced page view, full post script support and much more.

Highly Recommended only £49.99

or £105.99 with Cumana 3.5" external drive

PLATINUM WORKS

As recommended by Commodore we believe this to be one of the best all round integrated business packages on the Amiga. It comes with Platinum Scribble w/p, spell checker, thesaurus, Analyse (a Lotus 123 compatible spreadsheet with 3D graphics), a database, sideways printing utility and communications software plus the best selling Digita Home Accounts package

only £49.99!!

DIGI-VIEW GOLD MEDIA STATION

The new complete graphics creation presentation package for your Amiga. Comes complete with the famous Digi-View Gold, Digi-Paint and Elan Performer

only £129.99

WORDWORTH V1.1

The latest version of this highly acclaimed WYSIWYG word publisher. Comes with multiple fonts, powerful thesaurus, large spellchecker, speech synthesis

only £74.99

PENPAL 1.4

This best selling word publisher incorporates many features found only in a desk top publisher. Also includes an easy to use database.

now only £54.99

PAGESTREAM 2.2

The latest version of this powerful DTP package that we recommend. Better than alot of DTP packages on a PC and better than most on a Mac

only £139.99

IMAGINE V2

The latest version of Imagine, the ultimate 3D animation rendering system

only £199.99!

AMIGA RELEASE 2 2.04 UPGRADE KIT

Complete with:

- * Kickstart 2.04 CHIP
- * Workbench 2.04, Install, Fonts and Extras disks
- * full Commodore manual set

only £79.99

3D Text Animate.....now only £9.99

Aegis Sonix.....£39.99

Art Department Pro 2.1.....£109.99

Amos Creator.....£34.99

Amos Compiler.....£22.99

Amos 3D.....£27.99

Audio Engineer.....£169.99

Audio Master version 4.....£39.99

Broadcast Titler.....only £149.99

CrossDos.....£19.99

Deluxe Music Costruction Set.....£54.99

Deluxe Paint 3...now only £16.99

Deluxe Paint 4...now only £57.99

Easy AMOS.....£26.99

Flexidump printer utility.....£31.99

DEVPAK 3.....£57.99

GB Route Planner.....£29.99

Gold Disk Office.....£64.99

Home Accounts 2.....£37.99

Opus Directory.....£34.99

Pagesetter 2 DTP.....£42.99

Platinum Scribble w/p inc spell checker/thesaurus.....now only £29.99

Pro Page professional V3 DTP...£149.99

Protect 4.3 W/P.... now only £39.99

Pro Video Plus.....£139.99

Quarterback hd backup util...only £24.99

Quarterback Tools the ultimate Amiga utility disk !!...only £47.99

Sequencer One.....£74.99

SuperPlan Spreadsheet.....£29.99

Vista.....£29.99

Vista Pro 2 (2 Mb required)...£69.99

Walt Disney Animator.....£68.99

Xcopy Pro inc . hardware.....£33.99

PERIPHERALS

GENLOCKS

Rocgen Genlock

with built in mode switch box and auto pass thru function, the Rocgen represents excellent value for money

only 99.99

Rocgen Plus

with all the features of the standard Rocgen. Also includes dual control for overlay and keyhole effects, extra RGB pass thru allowing real time graph editing.

only £129.99



The Zy-Fi Stereo System

This is a powerful 3 way speaker system with built in stereo amplifier. It will plug into an Atari STE, Commodore Amiga or Acorn Archimedes.

The speakers are optimised with reflex ported cabinets. The 3 way system has bass, mid range and treble drivers.

Complete with its own power supply the Zy-Fi system can also be powered by batteries

only £36.99

CUSTOM CHIPS

Kickstart 1.3...£29.99

Kickstart 2.04...£42.99

Fatter Agnes...£37.99

Super Denese...£34.99

2 Way Parallel port sharer inc. cable

Many peripherals such as printers and scanners share the Amiga parallel port causing the user to have to swap between the two. Solve this problem with the 2 way sharer box

only £17.99

ROCTEC MOUSE

This is an excellent high quality mouse for the Amiga. Fully micro-switched mouse. Excellent value and highly recommended.

only £16.99

or £19.99

with mouse mat & holder

DRAM CHIPS

256 by 4 DRAM (DILs) ideal for A590 & Supra Hard drives plus many other Amiga RAM applications

QTY

4+ (512K)...now only £3.79

8+ (1Mb)...now only £3.59

16+ (2Mb)...now only £3.29

1 Mb by 8 or 9 SIMM boards as used in GVP and Cortex boards

now only £29.99

4 Mb by 9 Simms (for GVP)

only £114.99 each

1 Mb by 4 ZIPS

as used in Supra boards. 2 1 Mb by 4 ZIPS equal 1 Mb

only £38.99 per Mb

NAKSHA MOUSE

This famous and best selling mouse comes complete with Operation Stealth, mouse mat, holder and 2 year warranty. Features include 290 DPI resolution

only £24.99

DISKS

All Phoenix 3.5" disks are GUARANTEED FOR A LIFETIME and are CERTIFIED 100% ERROR FREE double sided, double density disks are of the highest quality in magnetic media and are extensively used by duplicating houses

QTY	Phoenix Bulk	OR	Sakura Branded
10	£4.99		£6.99
25	£11.99		£13.99
50	£21.99		£25.99
100	£39.99		£44.99
200	£72.99		£84.99
500	£169.99		n/a..
1000	£339.99		n/a..

Disk Labels...500.....now only £6.99
Disk Labels...1000.....now only £9.99

SUPRA RAM

The ultimate Amiga A500 expansion. Take your A500 up to 9 Mb (10 Mb with the A500 Plus). Fits onto the side expansion port Auto configures with no software patching.

Please note that when 256*4 ZIPS are used, the Supra RAM can only be populated to a maximum of 2 Mb. If you use this configuration and want to further increase your capacity you must replace the 256*4 ZIPS with 1 Mb by 4 ZIPS.

8Mb pop to 1Mb.....£99.99

8Mb pop to 2 Mb using 256*4zips.... £124.99

8Mb pop to 2 Mb using 1Mb*4 zips.. £149.99

8Mb pop to 4 Mb.....£209.99

8Mb pop to 8 Mb.....£309.99

512K RAM EXPANSION

Top quality RAM expansions for the A500 complete with battery backed clock and on/off switch. This RAM expansion will not in any way invalidate your Amiga warranty!!

now only £24.99

MAIL ORDER? WHY FIRST CHOICE?

Order by telephone quoting your credit card number. If paying by cheque please make payable to FIRST CHOICE. In any correspondence please quote a contact phone number and post code. Allow 5 working days for cheque clearance

Mail order Hotline 6 LINES

0532 637988

Prices are subject to change without notice. E&OE.

- * All prices include VAT and Standard Delivery
- * All hardware/computers are genuine UK spec.
- * Free Fast Standard 4 to 7 day Delivery
- * Guaranteed 2 to 3 day Delivery only £2.00
- * Guaranteed Next Day Delivery only £4.50
- * Open seven days a week for your convenience

PLEASE ADDRESS ALL CORRESPONDENCE TO:

DEPT AF, UNIT 8, ARMLEY PARK COURT, OFF CECIL STREET, LEEDS, LS12 2AE

Imagine being able to put together a song in a particular style without writing each part from scratch. **Maff Evans** powers up his synth and finds out whether it is actually possible.

SuperJAM!

Music Composer ■ £99 ■ Blue Ribbon Soundworks

AMIGA FORMAT

122

MAY 1992

A LOT OF PEOPLE have the opinion that many of today's chart hits are written around a few basic formulae. Some even go as far as to say (rather jokingly) that some use computers to write their songs for them, churning them out at the push of a button. Well now it has finally happened. There actually is a program that allows you to construct songs in a predefined style. That program is *SuperJAM!*

Whereas most electronic and computer-based music is created by building up a track in sections on a sequencer, *SuperJAM* takes an interesting side-step. Instead of laying down each part separately (bass, keyboards, drums and so on) and constructing a final song using the layers, *SuperJAM* allows you to create a template of a musical style and use it to generate a complete track. This may sound rather strange, but it is a relatively simple way of building up pretty proficient songs – even if you don't know a major chord from a minor.

SuperJAM employs a novel method of creating songs that combines elements found on normal sequencers with algorithms for putting together patterns created from a list of styles. Variations are introduced by setting up your own chord patterns and adding fills every now and then for a touch of originality. So how does all this work? Well, it's actually a lot simpler than you may think...

The first thing to do is to create a 'band' to play your song. Clicking on the Band button in the command strip calls up a list of instrument settings. This is where the instruments that will play each layer of your song are selected and they consist of drums, bass, keyboards, guitars, strings and lead. Although they each have a particular title, they can be any instrument you want, keeping in mind the part that each instrument will play in the final composition. For example, the drums should stay percussive, while the string section can be any 'pad' sound (such as an organ, string or choir sound). The sounds can either be played on a MIDI instrument (provided it has multi-timbral capability) or using built-in samples.

Using the Amiga's sound gives access to another feature new to *SuperJAM* – Turbosamples. This is a new sound technique which allows you to play more than the usual four channels of sound (the manual quotes the maximum possible at one time as 16, although

SuperJAM works via a system of individual windows, much in the same way as *Bars and Pipes Professional*. Most windows can be accessed from other sections as well as from the main control strip, which allows you to edit several things at once.

SuperJam! is available from Zone Distribution: 071-738 5444

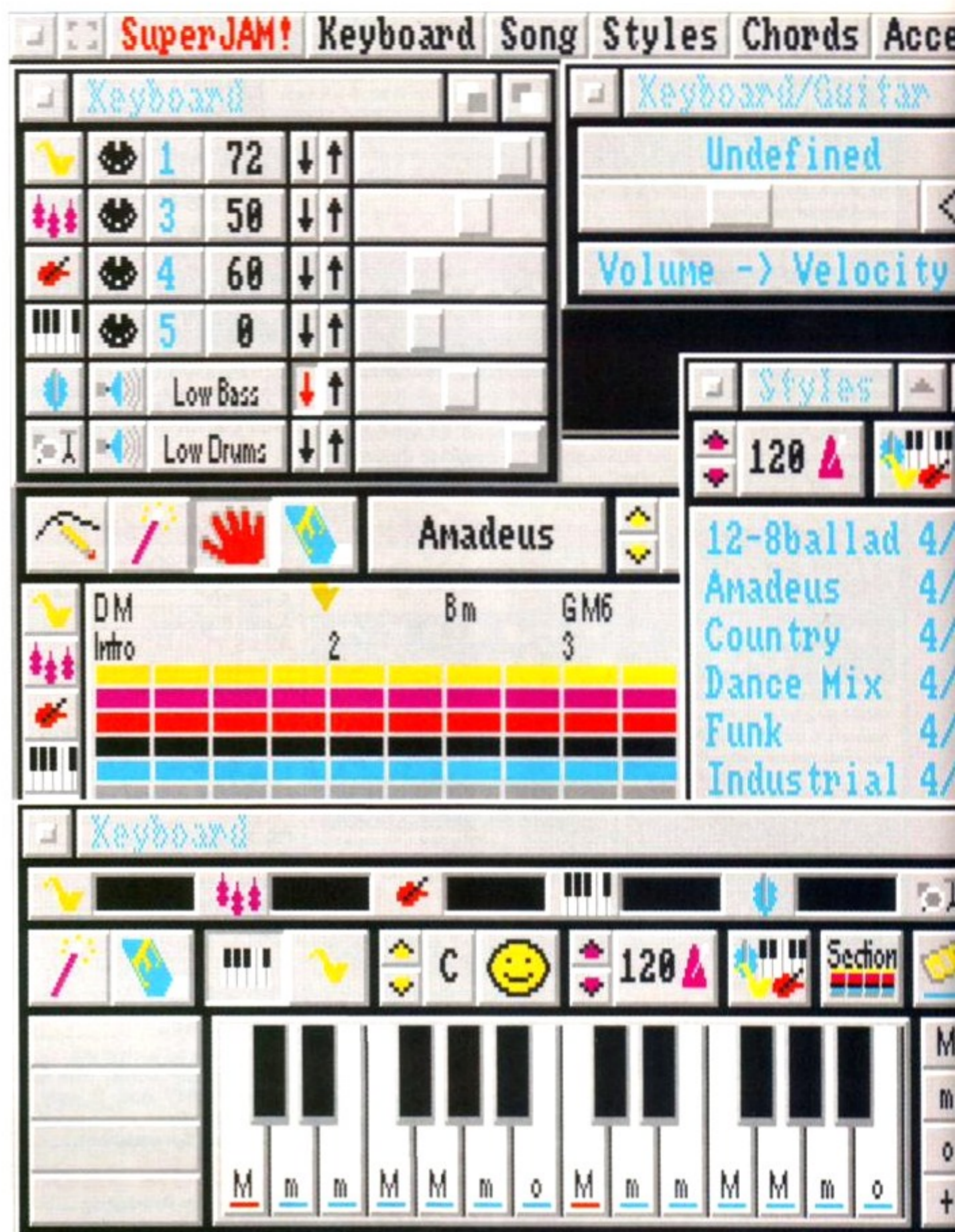

accelerated machines can often handle even more). This is an interesting possibility in theory, but in practice the sounds tend to be quiet and a little distorted. However it is hardly surprising that a reduction in quality occurs when you consider the processing power that this requires! If the sampled sound isn't quite what you are after, you can open up a sample editing window that gives you a large amount of control over the sound wave itself. You can access a new sound, set its loop on or off, program its amplitude envelope, select which key to play it in and which octave the notes should cover – all by clicking on easily identifiable buttons or dragging a slider.

Once you've got your band together, you can start creating a song. To do this you can either select one of the many included styles (ranging from Bossanova to rock) or create your own from scratch using the style editor. Although this may seem bewildering at first, the layout makes it easy to set up a customised style. I managed to create a hard, industrial dance style in a little over 10 minutes!

Once the band and musical style have been set up, you can go to the keyboard window and start practicing ideas for your song. Simply select a style from the panel and hit the

keys on the picture to start improvising chord progressions and fills in the style of your choice. When you think you've worked out a chord pattern that will work in a song, you can go to the Section Editor and start putting them in a sequence.

Actually putting together the song is simplicity itself. All you have to do is create the sections of the song (intro, verse chorus and so on) and paste them onto the song panel.

To create a section, you simply click on the Section button, give it a name and a length and a window pops up ready for editing. By clicking on the Play button you can hear the basic song in the default key. While the section is playing, you can alter the key of a bar by selecting a new key in the Keyboard window, clicking on the arrows next to the current key or playing notes on your MIDI keyboard. The program will then play the section following the chord progressions, but keeping in the selected style. You can even add extra embellishments by putting fills, breaks and end points in the bar, or muting instruments at certain points to give the track more depth.

If you're not quite happy with a particular section, you can open a window to edit the notes individually. This allows you to come up

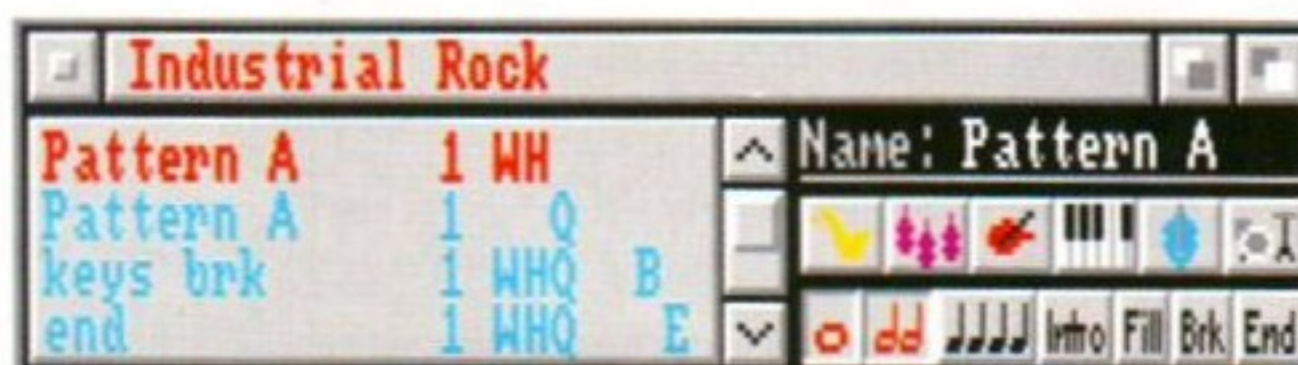

Once you've selected your style, you can edit the various patterns involved by setting the types of note and variation or by creating a pattern of notes just from scratch.



As well as using chords note types to create your music, you can access a grid for each instrument to place the notes exactly where you want them to appear.

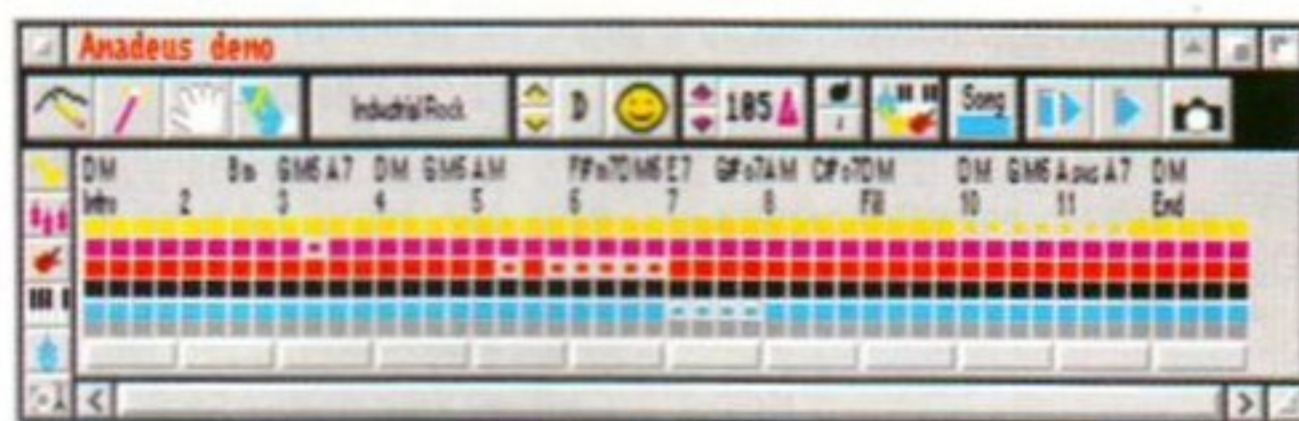

After setting a name and length for a section, you can change the chords, enter fills and embellishments and mute tracks to give your song its own feel.



After selecting a style, you can improvise (or jam) in that style by

simply clicking on the chords in the keyboard window. When you think you've come up with something useful, you can then enter it in a section.



When all the sections are finished, you can construct them into a final song. All you have to do is duplicate sections you want to appear more than once, then arrange them into the right order. Now you're ready to listen to the whole song from start to finish.

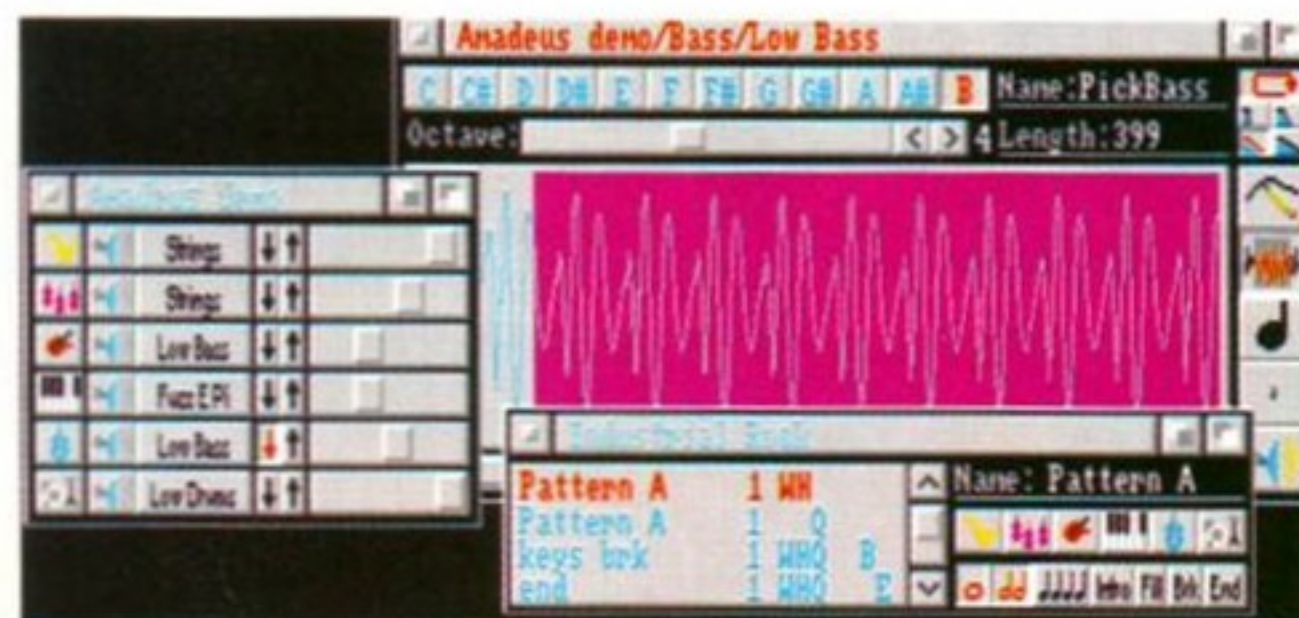

SuperJAM allows you to create a six-piece band comprising of MIDI instruments and Turbosamples. Opening the windows gives you access to the MIDI information or the sound wave itself, ready for you to start editing.

country style while the drums are industrial and the chords are in the style of Amadeus Mozart. A strange combination which is easily made a reality using *SuperJAM!*

SuperJAM is without doubt a highly entertaining musical tool which has a lot more uses than it first appears. The idea of having a program that writes music for you may seem a bit stupid, but once you've actually seen *SuperJAM* working you realise that it has a lot of potential. You can use it to store banks of instruments ready to use in a live performance; set up styles and patterns to use in your own sequences; or create an entirely original song by editing the parameters to your heart's content. This power is enhanced by the ability to run *SuperJAM* from within *Bars and Pipes Professional*. Using this powerful combination, you can pass sequence data between the programs, allowing you to edit totally individual patterns and construct a song using *SuperJAM's* incredibly friendly interface, then pass the data to *Bars and Pipes* ready for final editing and construction using its more comprehensive sequencer tools.

Some part-time musical hobbyists may get tired of using the system after a while, admittedly, since *SuperJAM* (despite its simple-to-use approach) is more suited to the professional musician who has to write music quickly in a certain style. In the case of the amateur, writing songs is carried out in a very different way to the professional songwriter. Whereas an enthusiast will come up with an idea and play around until it sounds right, a jingle writer has to produce a piece of music that fits the brief they are given. Given this situation, *SuperJAM* could well be an extremely useful addition to their musical set-up. It allows you to construct highly complex and proficient pieces of music that are governed by style rules. All you'd have to do is call up your 'hairspray commercial' algorithm and start creating music.

For this use, *SuperJAM* is unrivalled. Its powerful features, massive expandability and ease of use make it an extremely efficient song-writing package, but it may not suit everyone's creativity needs.

SuperJAM!

SPEED

●●●●● Pretty nippy in most areas, but can take its time when accessing floppy disks.

DOCUMENTATION

●●●●● A well laid-out manual in plain English with lots of diagrams and tutorials to lead you through.

ACCESSIBILITY

●●●●● Can be confusing at first, but anyone who has used *Bars and Pipes* will have no trouble.

FEATURES

●●●●● A wide range of functions make it a useful tool - almost as powerful as a full sequencer!

VALUE

●●●●● For the price, *SuperJAM* is very powerful, but be sure that you'd make use of it before you buy.

AMIGA
Verdict
FORMAT

87%



AMIGA 1.3 MEGAPACK - Stocks VERY limited -

AMIGA 1.3 VERSION COMPUTER Only version guaranteed to run all Amiga software	RRP £349.95	TAILOR MADE DUSTCOVER	RRP £6.99
1 MEG UPGRADE BOARD Increases your A500 to a massive 1 Megabyte of RAM	RRP £29.95	16 NIGHTS HOLIDAY ACCOMODATION	
WICKED 50 GAMES PACK 50 great games to get you going!	RRP £24.95	•PLUS• PD DISK PACK CONTAINING Wordprocessor • Spreadsheet • Database • Virus Killer • Backup Utility	
FIGHTER MICROSWITCH JOYSTICK Essential to play your 50 games	RRP £7.99	TOTAL RRP £426.82	
QUALITY MOUSEPAD	RRP £6.99	But yours for an unbelievable... £299.95	

ALL OUR AMIGA PLUSSES NOW COME WITH A MASSIVE 2 MEG OF RAM

PROFESSIONAL VIDI PACK

A500+ CARTOON CLASSICS PACK Complete with Bart Simpson • Captain Planet • Lemmings • D Paint III	RRP £399.95
2 MEG RAM BOARD (latest blue pcb design) Increases your A500+ to a massive 2 megabytes of RAM	RRP £59.95
VIDI-AMIGA Plus VIDI CHROME Frame grabber complete with colour software and filters	RRP £129.95
VIDI - RGB Electronic colour splitter	RRP £79.95
TAKE 2 Latest animation package from ROMBO	RRP 99.95
PHOTON PAINT This is in addition to D Paint III - the choice is yours	RRP £49.95
QUALITY MOUSEPAD	RRP £6.99
TAILOR MADE DUSTCOVER	RRP £6.99
•PLUS• PD DISK PACK CONTAINING Wordprocessor • Spreadsheet • Database • Virus Killer • Backup Utility	
TOTAL RRP £833.68 But yours for an unbelievable... £499.95	

GAMESMASTER PACK

A500+ CARTOON CLASSICS PACK Complete with Bart Simpson • Captain Planet • Lemmings • D Paint III	RRP £399.95
2 MEG RAM BOARD (latest blue pcb design) Increases your A500+ to a massive 2 megabytes of RAM	RRP £59.95
ASTRA TEN GAMES PACK Datastorm • Dungeon Quest • E Motion • Grand Master Slam • Kid Gloves Powerplay • RVF Honda • Shufflepack Café • Soccer • Tower of Babel (NB All games individually packaged)	RRP £229.78
WICKED 40 GAME PACK 40 great games to get you going!	RRP £24.95
2 FIGHTER MICROSWITCH JOYSTICKS Not one but two quality joysticks	RRP 15.98
QUALITY MOUSEPAD	RRP £6.99
TAILOR MADE DUSTCOVER	RRP £6.99
•PLUS• PD DISK PACK CONTAINING Wordprocessor • Spreadsheet • Database • Virus Killer • Backup Utility	
TOTAL RRP £744.59 But yours for an unbelievable... £399.99	

PROFESSIONAL MUSIC PACK

A500+ CARTOON CLASSICS PACK Complete with Bart Simpson • Captain Planet • Lemmings • D Paint III	RRP £399.95
2 MEG RAM BOARD (latest blue pcb design) Increases your A500+ to a massive 2 megabytes of RAM	RRP £59.95
MUSIC X 1.1 (latest version) Renowned as the best professional package on the market	RRP £149.95
QUALITY MIDI INTERFACE Now you can hook up to any midi keyboard	RRP £34.95
2 x MIDI CABLES Not one but two quality cables	RRP £13.98
QUALITY MOUSEPAD	RRP £6.99
TAILOR MADE DUSTCOVER	RRP £6.99
•PLUS• PD DISK PACK CONTAINING Wordprocessor • Spreadsheet • Database • Virus Killer • Backup Utility	
TOTAL RRP £672.76 But yours for an unbelievable... £399.99	

MONITORS / TVs

All our monitors/TVs come with the following value pack worth over £90 COMPLETELY FREE!
Value pack comprises:-

GFA BASIC The most comprehensive programming language	RRP £49.95	CLIP-IT PAPER HOLDER	RRP £8.99
10 DS/DD DISKS	RRP £9.99	MOUSE HOUSE	RRP £6.99
10 CAPACITY STORAGE BOX	RRP £4.99	• PLUS • PD DISK PACK CONTAINING Wordprocessor • Spreadsheet • Database Virus Killer • Backup Utility	
SCART LEAD TO YOUR COMPUTER	RRP £9.99		
GOLDSTAR 14" TV/MONITOR Complete with remote control and sleep timer Incredible value for money		But yours for an unbelievable	
TOTAL RRP WITH VALUE PACK £325.79		£199.95	
PHILLIPS 3332 15" FST TV/MONITOR High quality FST TV/Monitor with dedicated monitor output infra red remote controlling a host of features Complete with 2 year guarantee		But yours for an unbelievable	
TOTAL RRP WITH VALUE PACK £330.75		£239.95	
PHILLIPS 8833/II STEREO COLOUR MONITOR Simply the most popular monitor on the market FREE F19 Stealth Fighter * 12 month on-site service warranty		But yours for an unbelievable	
TOTAL RRP WITH VALUE PACK £390.75		£249.95	
PHILLIPS 2331 15" FST TV/MONITOR Same specification as 3332 but with Teletext Full range 3 speaker sound output Incredible value for money		But yours for an unbelievable	
TOTAL RRP WITH VALUE PACK £360.75		£269.95	
COMMODORE 1084S STEREO COLOUR MONITOR Dedicated Commodore monitor Colour co-ordinated to complement your Amiga		But yours for an unbelievable	
TOTAL RRP WITH VALUE PACK £390.75		£269.95	
★ EXTRA SPECIAL OFFER ★ WHILE STOCKS LAST		£239.95	

THE ALL NEW AMIGA 600 PACK* EXCLUSIVE TO FUTUREWORLD *

VERY LATEST AMIGA	A600 PACK	A600 (inc Deluxe Paint III)	RRP £399.99	
FEATURING:	Astra Ten Games Pack	RRP £229.78	GFA BASIC	RRP £49.95
★ On site maintenance	TOTAL RRP = £679.72		But yours for an unbelievable	£399.99
★ Kickstart/Workbench 2.05				
★ Built in TV/Modulator				
★ Smart Card Slot				
★ IDE Hard Disk Controller (optional 20Mb Internal Hard Disk)	A600 HD PACK	AS ABOVE BUT FEATURING 20Mb Hard Disk	TOTAL RRP £779.72	£499.99
			But yours for an unbelievable	

AMIGA 1500 CARTOON CLASSICS SUPERPACK

NEW AMIGA 1500 featuring Workbench/Kickstart 2, The Works, D Paint III, Home accts etc	RRP £699.95
ASTRA TEN GAME PACK 10 individually pack games (see A500 Gamesmaster pack for details)	RRP £229.78
GFA BASIC Essential for basic programming	RRP £49.99
CARTOON CLASSICS SOFTWARE Bart Simpson Vs Space Mutants • Lemmings • Captain Planet	RRP £79.97
2 FIGHTER JOYSTICKS	RRP £15.98
QUALITY MOUSEPAD	RRP £6.99
TOTAL RRP £1082.62 But yours for an unbelievable	£599.95

MEMORY DRIVES & SCANNERS

MEMORY	512K RAM EXPANSION WITHOUT CLOCK	£19.95	WITH CLOCK	£24.95
	1.5 MEG EXPANSION (Not Plus compatible)			£79.95
	1 MEG EXPANSION (Gives your A500 plus a massive 2MB)			£39.95
	1 MEG EXPANSION WITH THRU-PORT			£49.95
	NEW 8 MEG RAM BOARDS FROM POWER Complete with Thru-Port Populated board with 0Meg RAM £99 • 2 Meg RAM £129 • 4 Meg RAM £189.95 • 8 Meg RAM £299.95			
DRIVES	DIRECT A500 REPLACEMENT DRIVE with instructions			£44.95
	POWER PC880E Robust slim drive with anti-click			£49.95
	CUMANA CAX 354 SLIMLINE DRIVE			£54.95
	POWER PC 880B with Blitz/Virus hardware			£69.95
	POWER PC880B+ X-COPY PROFESSIONAL			£99.95
	DUAL POWER PC880B complete with Power supply			£124.95
HARD DRIVES	GVP 52 MEG HARD DRIVE WITH RAM EXPANDABLE TO 8MB			
	0 Meg RAM £379.95 • 2 Meg RAM £429.95 • 4 Meg RAM £499.95 • 8 Meg RAM £679.95			
	GVP 105 MEG HARD DRIVE WITH RAM EXPANDABLE TO 8MB			
	0 Meg RAM £579.95 • 2 Meg RAM £629.95 • 4 Meg RAM £729.95 • 8 Meg RAM £899.95			
SCANNERS	POWER SCANNER WITH VERSION 2.0 SOFTWARE			£99.95
	UPGRADE KIT FOR NON POWER SCANNER UNITS			
	Complete with hardware interface and new version 2.0 Software			£49.95

Future World

computers

ALL PRICES INCLUDE VAT & COURIER DELIVERY

STAR PRINTERS

All our Star Printers now come with the following value pack worth £34.96 COMPLETELY FREE

- QUALITY COMPUTER CABLE RRP £9.99
- UNIVERSAL PRINTER STAND RRP £9.99
- 200 SHEETS CONTINUOUS PAPER RRP £4.99
- TAILOR MADE DUST COVER RRP £9.99
- 16 NIGHTS HOLIDAY ACCOMODATION
- PLUS• PD DISK PACK CONTAINING
Wordprocessor•Spreadsheet• Database•
Virus Killer•Backup Utility

STAR LC20 MONO PRINTER

9 Pin Dot matrix 180/45 cps
TOTAL RRP with value pack £268.01

But yours for an unbelievable **£149.95**

STAR LC200 COLOUR PRINTER

9 Pin colour 185/45 cps
TOTAL RRP with value pack £339.29

But yours for an unbelievable **£209.95**

STAR LC24-200 MONO PRINTER

24 Pin mono printer 220/55 cps
TOTAL RRP with value pack £386.29

But yours for an unbelievable **£249.95**

STAR LC24-200 COLOUR PRINTER

24 pin colour printer 220/55 cps
TOTAL RRP with value pack £445.04

But yours for an unbelievable **£299.95**

SERIOUS SOFTWARE

WORD PROCESSORS

- QUICKWRITE basic but efficient and easy to use £59.99
- PENPAL Ideal for both beginners & experienced users £79.99
- WORDWORTH Industry standard, the best! £129.99

DATABASE

- K-DATA Affordable, reliable & easy to use £51.99
- SUPERBASE PROFESSIONAL £249.95

The ultimate, you can't get better

SPREADSHEET

- K-SPREAD 2 Simple & easy to use £63.99
- K-SPREAD 3 Enhanced version of above £81.99
- MAXIPLAN Well known powerful spreadsheet £69.99
- ADVANTAGE Powerful package for business users £99.99

UTILITIES

- PERSONAL FINANCE MANAGER £39.99
- HOME ACCOUNTS 2 £54.99

Suitable for home & small businesses

- DEVPAK 3 Extremely powerful assembler £69.99

GRAPHICS

- AMOS THE CREATOR Become a budding gamesmaker £49.99
- WALT DISNEY ANIMATION STUDIO £99.99

every cartoonists dream

MUSIC

- MUSIC X I.I Special purchase whilst stocks last £49.99
- BARS & PIPES Top of the range for the professional £148.99

SUPER ABC PERIPHERAL PACKS

- PACK B**
- 1/2 MEG UPGRADE BOARD RRP £29.95
 - 2 FIGHTER JOYSTICKS RRP £15.98
 - 40 CAPACITY LOCKABLE DISK BOX RRP £9.99
 - 10 DS/DD 3.5" DISKS RRP £9.99
 - TOTAL RRP £65.91
 - SUPER VALUE PACK PRICE £34.95**

- PACK A**
- QUALITY REPLACEMENT MOUSE RRP £19.99
 - SOLID PERSPEX DUST COVER RRP £12.99
 - QUALITY SEMI-SOFT MOUSEMAT RRP £7.99
 - TOTAL RRP £40.97
 - SUPER VALUE PACK PRICE £19.95**

- PACK C**
- 1 MEG EXPANSION BOARD RRP £59.95
 - 40 CAPACITY LOCKABLE DISK BOX RRP £9.99
 - 10 DS/DD 3.5" DISKS RRP £9.99
 - 3.5" DISK DRIVE CLEANING KIT RRP £7.99
 - TOTAL RRP £87.92
 - SUPER VALUE PACK PRICE £44.95**

PROFESSIONAL AMIGA REPAIRS

"Simply The Best" Commodore authorised repair centre

FREE COLLECTION & DELIVERY BY COURIER Make one simple phone call and leave the rest to us!

GUARANTEED 7 DAY TURN AROUND We guarantee to return your computer

WITHIN 7 days of collection

FULL OVERHAUL INCLUDING OVER 50 DIAGNOSTIC CHECKS Your Amiga will look as good as new

3 MONTH COMPREHENSIVE GUARANTEE Our engineers work to the highest standard

ALL INCLUSIVE PRICE We won't con you with hidden extras

FREE 50 GAMES SOFTWARE PACK

For a limited offer we will give you a 50 games pack completely free!

ALL FOR THE INCREDIBLE PRICE OF **£59.95**

NB Personal callers in to one of our stores may deduct £10 from the above price. We reserve the right to refuse computers that have been tampered with or are beyond economical repair. In this instance a nominal £10 charge will be made to cover carriage costs.

EXTEND YOUR WARRANTY TO A TOTAL OF 1 YEAR FOR ONLY AN ADDITIONAL £20.00

ORDERING MADE EASY



BY PHONE

Simply call our Head Office quoting your Access/Visa number on **0234 218060 (5 lines)**

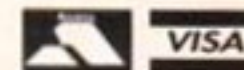

BY CALLING PERSONALLY

Simply call in to your nearest FutureWorld store where our fully trained personnel will be more than happy to deal with your requirements.



BY POST

Make cheques, Building Society drafts or Postal Orders payable to **FUTUREWORLD COMPUTERS LTD**
UNITS 25-27 SERGEANTS WAY
ELMS INDUSTRIAL ESTATE BEDFORD MK41 0EH

Please write cheque guarantee card number on the reverse of cheque to ensure same day clearance. Cheques without a card number subject to 10 days clearance.

REMEMBER ALL PRICES ARE INCLUSIVE OF VAT & COURIER DELIVERY (UK Mainland only)



FINANCE

Finance available to suit your specific needs. Written details on request
Instant credit is available in all FutureWorld stores

PREMIER GOLD CARD

- 7 day money back guarantee on goods purchased if not completely satisfied (subject to goods being returned in mint condition)
- 30 day exchange for new policy should a fault occur
- 1 year guarantee giving free collection and delivery service should a fault occur
- Exclusive Premier Gold Card with Personal Membership Number entitling you to special offers
- All this for only £19.95 per item purchased

1 YEAR GUARANTEE

For the whole guarantee period, warranty service will be completely free of charge

TECHNICAL SUPPORT/ON SITE ENGINEERS

Being authorised service centres for AMSTRAD, COMMODORE & STAR, we are equipped to deal with the majority of queries.

FULLY COMPUTERISED ORDERING SYSTEM

This enables our telesales staff to provide up-to-the-minute stock information coupled with efficient dispatch

FULL TESTING PROCEDURE

All computer hardware is tested prior to dispatch maintaining our motto;

Simply the BEST

All goods subject to availability
All prices correct at time of going to press

E & OE

YOUR NEAREST **FutureWorld** STORE



BEDFORD

70 High Street Bedford Telephone 0234 217070

NORTHAMPTON

1-7 College Street Northampton Tel 0604 33996

WELWYN GARDEN CITY

16 Church Road Welwyn Gdn City Tel 0707 390029

WATCH THIS SPACE

More stores opening soon!



THE HOME COMPUTER

Over the last ten years, the computer has established a permanent place in the home, and the number of home computer users increases dramatically every year.

Many people have yet to tap the full potential of their home computer and are constantly looking for new ideas and applications.

The most popular systems have proven to be the ST, Amiga and PC, and at the International Computer Show, you will be able to see, try and buy a whole range of products and services which will help you to maximise your use and enjoyment of these machines.

Working from home? In the home office feature you will see all the latest technology available for the small home office, including word processing, spreadsheets, desk-top publishing, upgrades, tele-networking and modems.

Looking to help your child's education? Many companies will show all the latest computerised educational courses from early learning to GCSE and beyond.

What about Multi Media? It is now possible to create, reproduce and store sound using your home computer thus enabling you to unleash your own musical creativity and improve your musical performance. Video and visual interfaces are another rapidly developing field where you can edit and change your home videos.

All this and entertainment too! Many exhibitors will be showing all the latest games software and of course the hand held games consoles - the fastest growing home computing niche.

So whatever your area of interest, you'll find the hardware, software, peripherals and consumables you'll need at the International Computer Show and all at great show prices.

Pre-purchase your fast lane tickets to save money and beat the queues. Simply call the ticket hotline number 0726 68020 for your tickets now. Or send the voucher with your cheque or credit card number. Closing date 3rd July 1992.

Ticket prices:

Admission on the door £6,

Under 10's £4

Fast lane tickets (before 3rd July 1992) £5, under 10's £3

Westminster
EXHIBITIONS

Westminster Exhibitions Ltd,
Surrey House,
34 Eden Street,
Kingston, Surrey KT1 1ER

For all your home computing needs

THE 6th International COMPUTER SHOW

Incorporating the
16 Bit Computer Show

Sponsored by



europress
Britain's top computer magazines

10th - 12th July 1992

Friday and Saturday 10.00 to 6.00, Sunday 10.00 to 4.00

**Wembley Conference
& Exhibition Centre, London**



WEMBLEY
VENUE OF LEGENDS

Nearest tube station - Wembley Park (Metropolitan & Jubilee Lines)
Easy access - On site parking - Follow the signs to Wembley
Wider gangways and facilities for the disabled

Europe's biggest show specialising in everything for the ST, Amiga, PC and consoles - Hardware, Software, Peripherals and consumables.

In addition to 180 companies showing the latest available for use in the home, there will be seminars, demonstrations, hands on opportunities, a home business feature area, free advice centres and rides! A fun day out for one and all!

To: International Computer Show,
PO Box 68, St. Austell PL25 4YB

Please send me _____ Fast Lane Tickets @ £5.

_____ Under 10's Fast Lane Tickets @ £3

I enclose a cheque/P.O./Credit card details for £ _____ made payable to
International Computer Show

Name _____

Address _____

Postcode _____

Credit Card No. _____ Expiry date _____

OR phone 0726 68020 to book with credit card

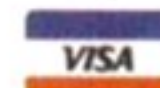

'Serious' muso **Maff Evans** pores over Dr T's latest release and finds a library full of sounds, plus an editing facility for your Amiga that can be used with most makes of synthesiser. Quiet please and read on...

WITH ALL THE advances in synth technology, a few problems have arisen. Firstly, the need to pack as many sounds and functions into a compact unit means that editing sounds and parameters requires some careful thought and a lot of button pushing, particularly when you consider that most current synths combine all their functions onto a small control panel. What can be done to overcome this problem? Simple, you can use MIDI to dump the information to an editor program on a computer.

This gives rise to a second problem. Although MIDI is a standard communication system for electronic instruments, the synths themselves are all very different. They have their own sound synthesis technique and their own methods of editing, making it difficult to find patch editors for a particular machine. Is there a solution? There is indeed – a Generic Patch Editor such as Dr T's *X-oR*.

So what is a Generic Patch Editor? It's a program that allows you to store and edit information for a wide number of synths, rather than a particular model. This is done by using templates (known as 'profiles') which correspond to the controls on a synthesiser. *X-oR* allows you to build a set-up containing a large number of profiles and stores them in a 'performance'. This means you can store banks of sounds and access them in one go, effectively saving the state of your entire MIDI set-up.

As well as storing and editing individual sounds and banks of patches, *X-oR* also includes a few extra features. The most significant of these extra options is the Patch Library. This is a database which can store individual sounds and patches, along with lists of keywords to allow you to cross reference sounds. For example, you can search out bass sounds that are acoustic, but only those that have a soothing quality. This can save time when trying to find that perfect sound for a track.

Users who have access to Dr T's *X-oR* can also store patch editing information along with their sequences, so a sound can be altered as a song progresses.

These features without a doubt make *X-oR* an extremely powerful patch editor and librarian system, but one aspect of the program gives rise to a lot of problems. Since the system is open-ended, difficulties tend to occur due to the whim of the author of a particular profile.

For example, the program was tested for this review using a *Korg Wavestation*. When the factory presets were stored in *X-oR*'s banks and saved to disk, you'd expect them to restore the system to its default state. Wrong! The rhythmic backing of the patch 'Ski Jam' was wiped entirely, requiring a nifty bit of re-programming from the *Wavestation*'s front panel. Hardly the kind of thing you'd expect to

Before you can carry out any editing, you need to create a file containing the profiles for the machines in your MIDI set-up. This can be saved so that *X-oR* boots with the right set-up.

X-oR is available from Zone Distribution:
071-738 5444



Dr T's X-oR

Generic Patch Editor and Librarian ■ £219 ■ Zone Distribution

do when using a computer-based editor! In short, test the program before laying out the dosh to make sure that it will work with all the elements of your system.

Although this isn't a fault in *X-oR* itself, there are other elements of the program which annoy. The way you have to assign everything that you edit to a position before the program remembers it at all makes it difficult to edit a number of patches on the fly. You need to work on one at a time, store it and save it

before moving to another section, otherwise *X-oR* will forget everything you did! This isn't apparent to begin with, since the sound can be heard from your synth as you edit. It's not until you absently select another window and your lovely new sound vanishes that you realise – after much swearing!

Nothing about *X-oR* is intuitive. You have to know your synth inside out and understand all of *X-oR*'s options in detail before you start – which isn't helped by the confusing manual.

If you are running a MIDI set-up that contains a lot of different elements, then you may find *X-oR* very useful, because it allows you to edit and store 'snapshots' of your entire system, making it quick to recall complex configurations. If, though, you have a modest set-up of just one or two pieces of MIDI equipment, you're better off editing on the individual machines and using *X-oR* to save data to disk. However, £219 for a patch disk filer is over the top, which puts *X-oR* in the 'serious studio-owner's tool only' domain.

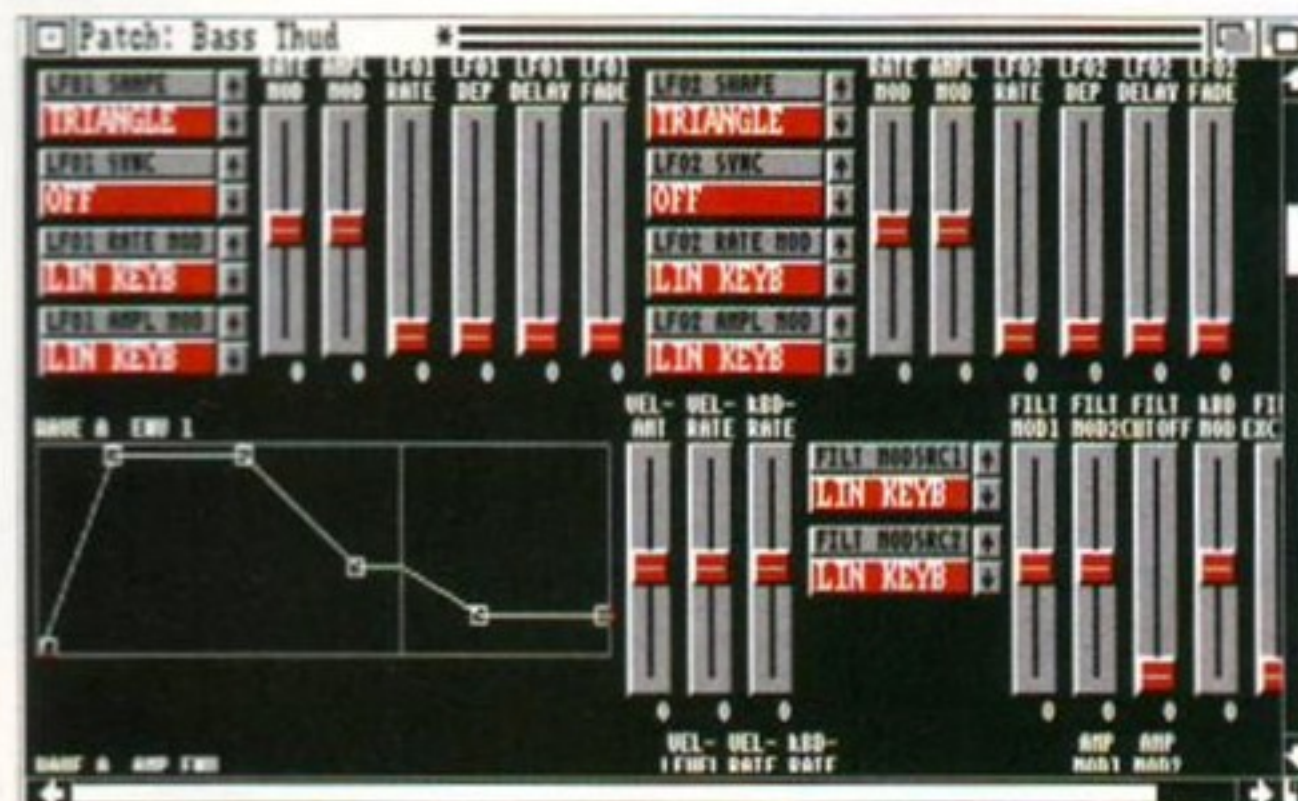

Using the patch editor, you can edit all the elements of your synth's basic sounds, including filter envelopes, LFOs, keyboard velocity and aftertouch.

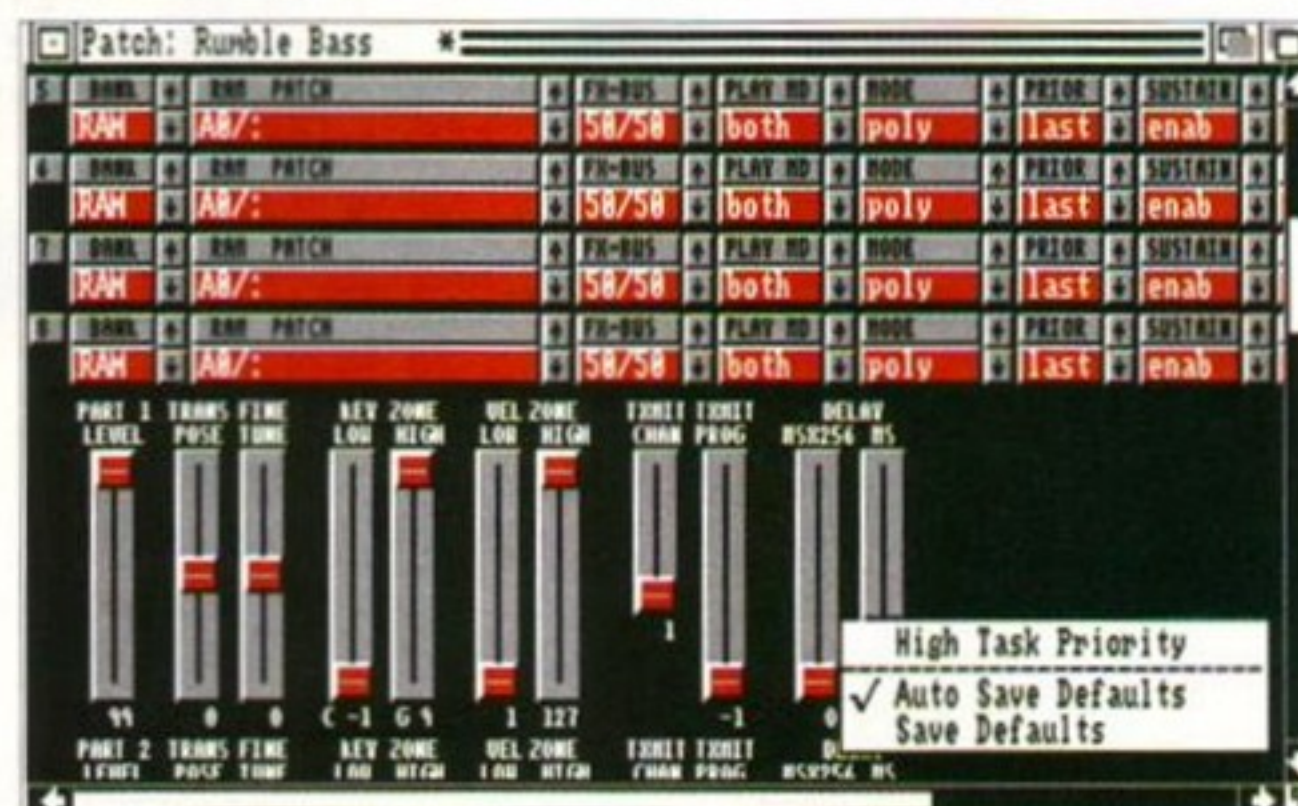

This screen is from the *Korg Wavestation* profile. From here you can choose sounds for an entire multi-timbral set-up and send it to your synth.

X-oR

SPEED ●●●

Tied by the constraints of MIDI data-dump timing, but other elements tend to be slow as well.

DOCUMENTATION ●●

Extensive, but hardly plain English. Be prepared to read the manual thoroughly at least twice.

ACCESSIBILITY ●●

You really need to know about synths and MIDI, but even then it's a little unfriendly.

FEATURES ●●●●

Patch editing, bank storage, MIDI set-up configuration and a librarian. What you'd expect really.

VALUE ●●●

A useful tool for the professional studio engineer, but over the odds for the keen hobbyist.

72%

AMIGA FORMAT

Micromail YOUR 'BEST PRICE'

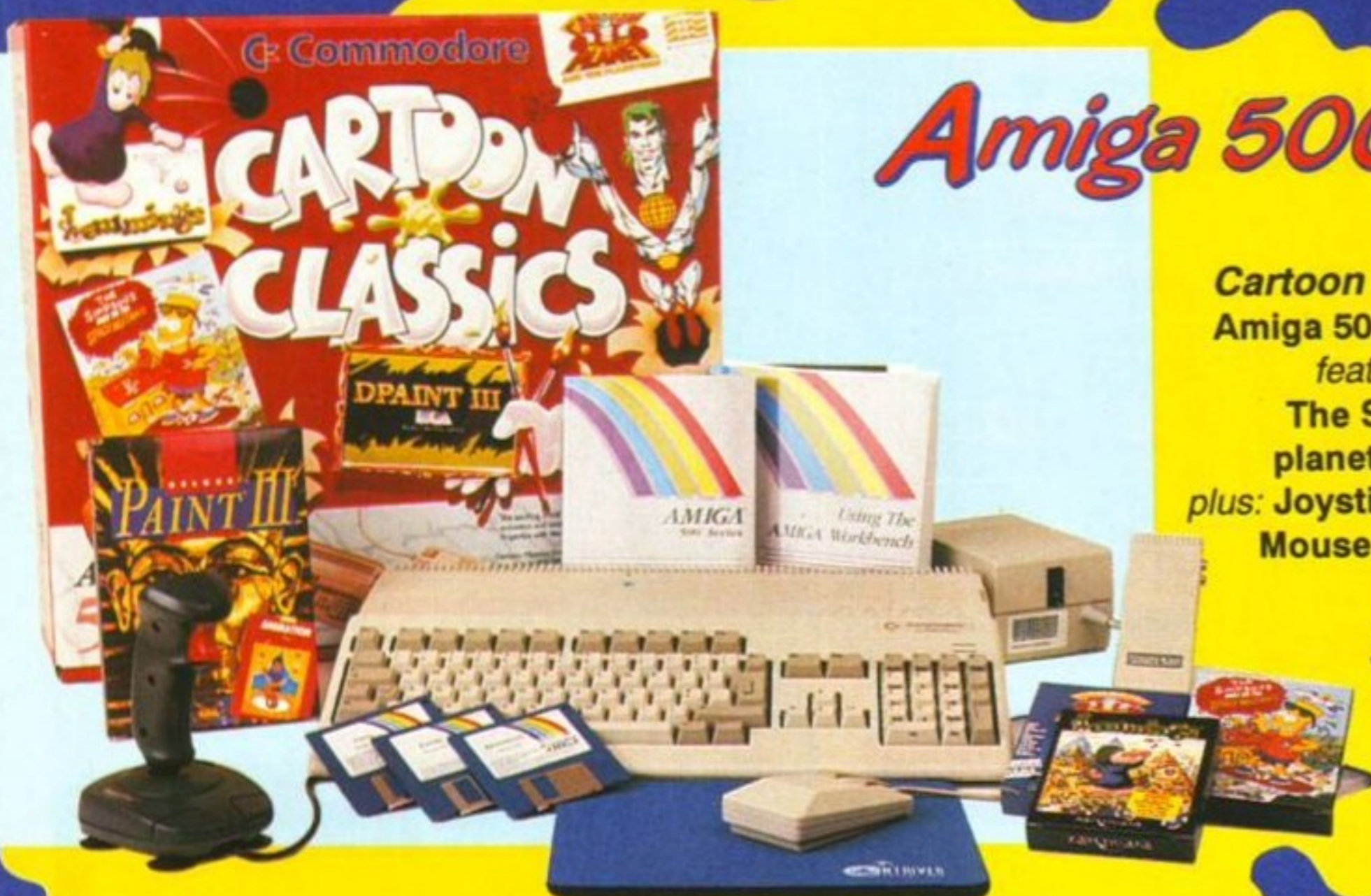

Amiga 500 Plus Cartoon Classics

Cartoon classics Superdeal I
Amiga 500 plus 1 Mb computer,
featuring: Lemmings
The Simpsons, Captain
planet and Delux paint III
plus: Joystick, A520 Video Adapter,
Mouse mat and Dust cover

£349.95

Cartoon classics Superdeal II
Amiga 500 plus 1 Mb computer,
Commodore 1084sp1 colour
monitor, featuring: software as
Superdeal 1, plus: Joystick,
10 Hit games, PD Spreadsheet
and Data base, Word processing,
10 Disks and additional
Dust cover.

£594.95

Educational Superdeals
Maths mania, Better spelling,
Hooray Henrietta and
Text plus.

At a special price of **£55.00**
When purchased with any
of the **Classic cartoon**
Superdeals.

**ALL PRICES INCLUDE
VAT UNLESS
OTHERWISE STATED**

**ALL MAJOR
CREDIT CARDS
ACCEPTED**

Printers

All printers come with leads

Star LC20 mono	£149.00
Star LC24-200 mono	£235.00
Star LC24-200 colour	£275.00
Star LC200 9 pin colour	£195.00
Star XB24-200 colour	£355.95
HP Deskjet mono	£353.00
HP Deskjet colour	£583.00
HP Laserjet IIP	£937.00
HP Laserjet III	£1192.00
HP Paintjet	£540.50



Monitors

Commodore 1084Sd1 colour	£219.00
Commodore 1083Sp1 colour	£219.00
Commodore 1950 M-sync	£586.00



Accessories

Amiga 500 Dust cover	£3.99
Monitor Dust cover	£4.99
Star LC24-200 Dust cover	£4.99
Star LC200 Dust cover	£4.99
Monitor stand	£12.99
Printer stand	£7.99
Joystick cable	£5.99
Mouse mat	£2.99
Naksha mouse	£24.99
Squick mouse PC	£17.99
Squick mouse A500	£24.99
Roboswitch	£9.99
Parallel printer lead	£10.99
Commodore A501 RAM	£39.99
Virgo RAM	£29.99
Control centre	£44.95
10 Disk box	£3.99
40 Disk box	£4.99
80 Disk box	£7.99
120 Disk box	£10.99
Rendel genlock	P.O.A

Consumables

Printer paper 1000 sheets	£12.99
Disks, 50 unbranded	£20.00
LC200 ribbon mono	£5.50
LC200 ribbon colour	£11.00
LC24-200 ribbon mono	£5.00
LC24-200 ribbon colour	£12.50

Sega

Sega game gear with Sonic	£120.95
Sega game gear TV tuner	£72.99
Sega master system II	£54.99
Sega mega drive with Sonic	£124.95



ATARI IBM

A full range of
Atari and IBM
Software available
on request

GOVERNMENT-INDUSTRY AND EDUCATIONAL
ORDERS WELCOME.

VISIT OUR SHOWROOM; OPEN MON TO SAT 9-5.30 OR RING

AMIGA SPECIALISTS

VISIT OUR SHOWROOM

Superdeals

Cartoon classics Superdeal III
 Amiga 500 plus 1Mb computer,
 Commodore 1084sp1 colour
 monitor, Star LC200
 colour printer featuring:
 software as Superdeal 1,
 plus: Joystick, 20 Hit games,
 PD spreadsheet and Data base,
 Word processing and two
 additional Dust covers.

£807.95

**ONLY
 £5.00
 MEMBERSHIP FEE
 TO OUR SOFTWARE
 DISCOUNT CLUB
 WITH
 PURCHASES
 OVER
 £25.00**

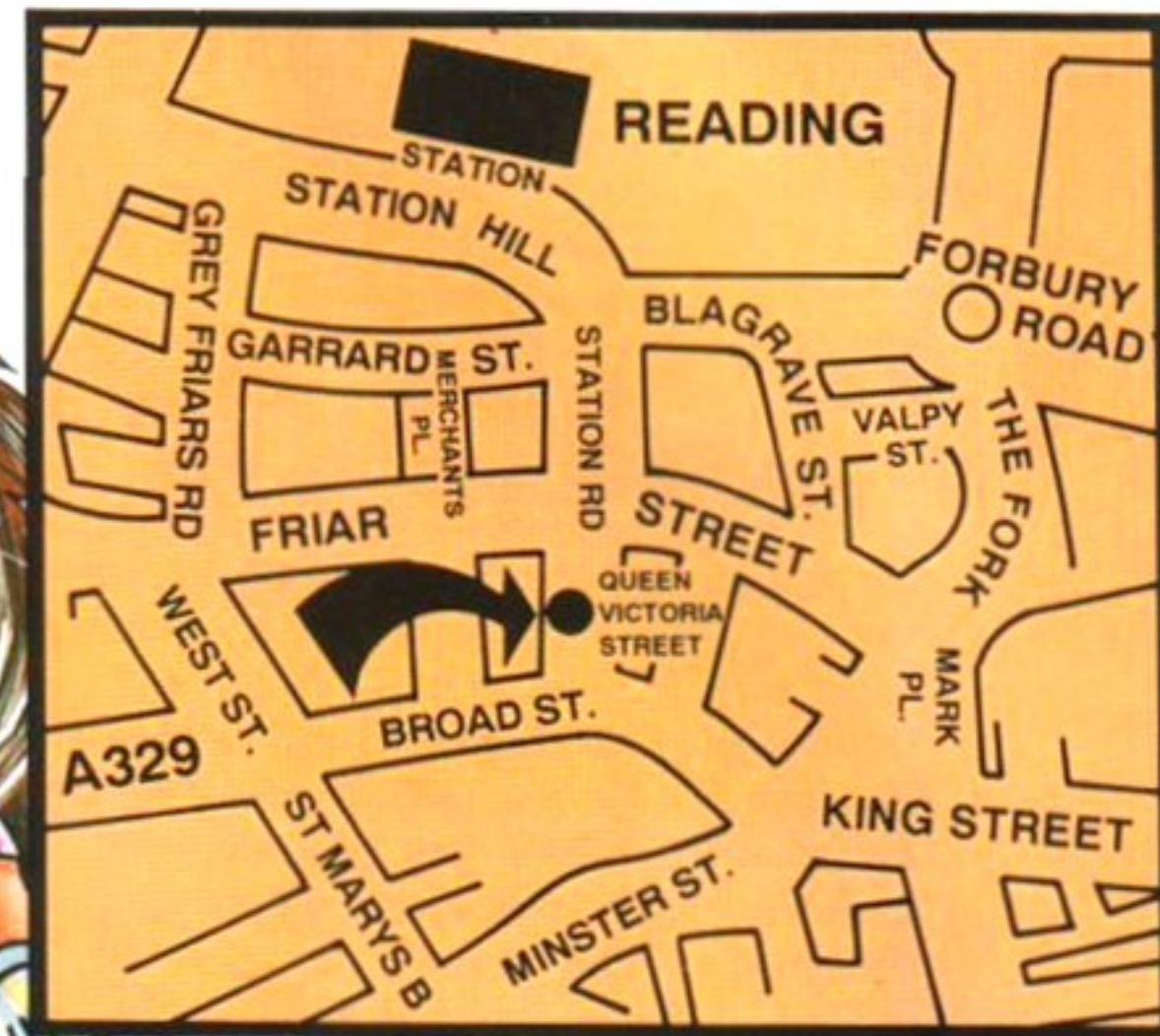

0734 505 514

THE NEW AMIGA 600 RANGE

- WITH BUILT IN MODULATOR
- 1 YEAR ON-SITE WARRANTY
- IMPROVED CUSTOMER SERVICE - SUPPORT

A600 R.R.P. £399.99
 A600 HD R.R.P. £499.99
 NOW AVAILABLE
 RING FOR DETAILS

Disk Drives

G.V.P hard drive 52 meg	£379.00
Cumana disk drive	£58.95
Rotec disk drive	£57.95
Roelite disk drive	£64.95

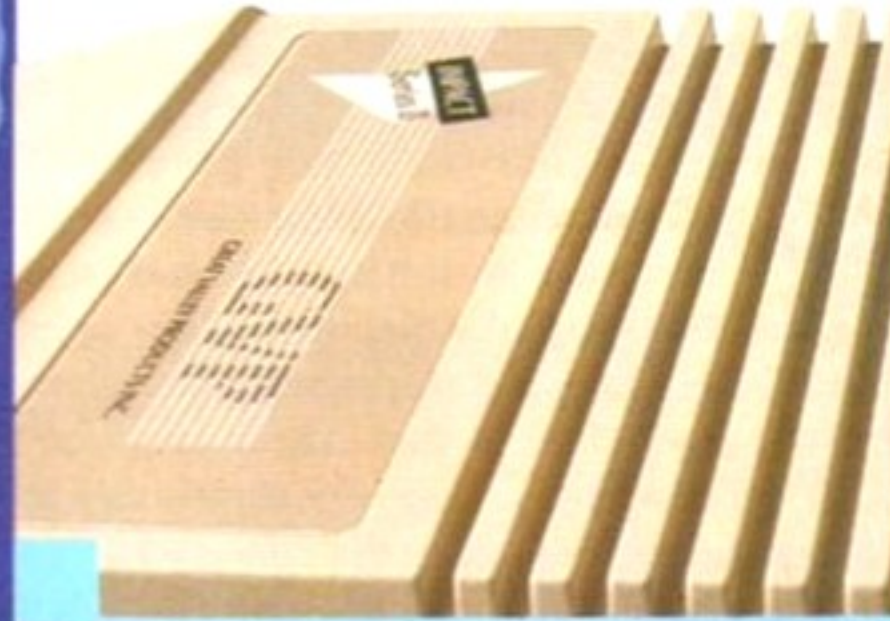

How to order

Next day delivery for credit card orders placed before 3.00pm subject to availability. Alternatively send cheque/postal order to Micromail Ltd, 8 Queen Victoria Street, Reading, Berkshire.

Please allow 5 working days for cheque clearance. Subject to availability despatch is normally within 24 hours of receipt of cleared payment.

DELIVERY CHARGES; UK	Mainland (not Highlands)
Small consumables & software items	Despatched by post, please check charges when ordering.
Other items except lasers	Next day courier service, £10.00 per box
Laser printers	Next day courier service, £17.50
Offshore & Highlands	Normal rate plus £10.00 + VAT per box
In addition we have the following express service:	
Saturday deliveries	Normal rate plus £10.00 + VAT, surcharge
7am - 9am next day	Normal rate plus £10.00 + VAT, surcharge
am next day	Normal rate plus £10.00 + VAT, surcharge
(the above surcharges are per box)	

Prices are subject to change without notice E & O E



8 Queen Victoria Street
 Reading
 Berkshire

Tel. (0734) 505514

Amiga Software

Eye of the Beholder 2	£22.99
EPIC	£20.99
Air Support	£17.99
Utopia Data Disk	£10.50
The Manager	£17.99
Monkey Island 2	£21.50
Vroom	£17.50
Sensible Soccer	£20.99
Hook	£17.50
John Madden	£17.99
Sim Ant	£23.50
Adams Family	P.O.A.
Might & Magic 3	£27.50
Parasol Stars	£17.50
Project X	£17.50
Fun School 2	£14.50
Fun School 3	£16.50
Fun School 4	£16.50

Joysticks

Apache 1	£5.99
Python 1.m	£8.99
Jet fighter	£11.99
Superboards	£14.99
Top star	£20.99
Cheetah Bug	£12.50
Aviator	£27.99
... and many others	

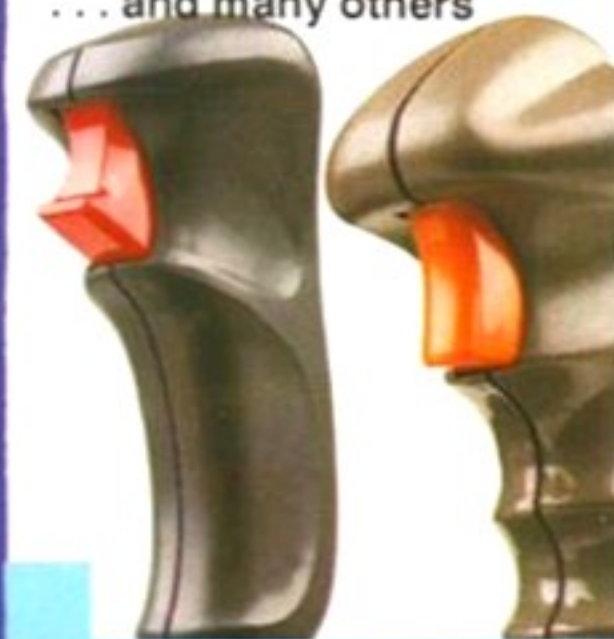

OUR SALES HOT LINE 0734 505514 FOR NEXT DAY DELIVERY

German hardware has long been regarded as excellent but inaccessible. **Pat McDonald** looks at a new digitiser about to break the mould.

VLab V1.0

Video Digitiser ■ £299 ■ MacroSystem

IMAGINE BEING ABLE to take a video tape, and transfer the pictures on to your Amiga's screen. That's what digitisers are all about – reading in video signals and changing them into Amiga IFF pictures.

Once a picture is inside the Amiga system, you can chop and change it to your heart's content using a paint program like *Deluxe Paint IV*. I think that *VLab* is probably the best all-round digitiser for the Amiga – assuming that you have *Workbench 2*, because *VLab* won't work with anything less.

Just as there are many different types of computer, in turn there are many different types of video connection. The most common by far is the composite video connector (also known as YUV). This is often found on domestic-quality video recorders and camcorders – if you've got one, you should see a simple 'video out' and maybe a 'video in' socket on the backplate. Being so popular most Amiga digitisers will only connect with YUV sources – and *VLab* is not an exception.

The difference is that, from this commonplace and humble source, *VLab* produces the best quality grabs possible. On the *VLab* board itself, all incoming video is stored into a dedicated video store or 'frame buffer', composed of 0.5Mb of computer memory. Remember, this memory is for the use of *VLab* only – you can't add it to the memory of your Amiga!

The big advantage is that this product can get pictures from live, moving video. All digitisers that cost less than *VLab* cannot do this easily, especially if you want colour pictures (and of course you *want* colour pictures). They must be connected to a video on pause, or to a video camera looking at a still, unmoving scene. If you wanted to get pictures from a moving tape, the cheapest frame grabber would cost £450 or more – so why is *VLab* so much cheaper?

The reason is that it can only be fitted into an A1500, A2000 or A3000, because it is just a card that slots in these machines. It has no case, and no power supply. Which means it's cheaper to make and move around the world than other, external frame grabbers. On the other hand, it is about twice as expensive as Rombo's *Complete Colour Solution* and three times more expensive than *Digiview Gold* from Newtek – so is the price right or is it an expensive gimmick?

It depends on how much digitising you're going to do. If you just want a few grabs to base rough sketches on, then a budget digitiser

ASTERIX
Cartoons are without a doubt the best subject for grabbing. In general, the small number of bright colours and the simplicity of the images makes for good grabs. Here's the same picture, only rather than using Amiga HAM (4,096 colours) this one is in full 24-bit mode.

LIVERPOOL
The worst subjects for digitising are televised sports. The fast action, wide range of colours and fine detail defeat a good computer representation. *VLab* managed an acceptable result from a poor video (notice the line bottom left).

TERMINATOR
Arnie's Terminator character dons shades for the first time – it's fun to capture bits of movie history like this for posterity.

VLab is available from Amiga Centre Scotland: 089 687583



will do fine. However, *VLab* has an ARexx port and a lot of ARexx commands. In English that means this digitiser could be set up to grab hundreds and hundreds of grabs automatically, by writing a short ARexx program. *VLab* is designed to be used professionally as a computer product – but don't think it's boring, because you can get quite engrossed getting just a few grabs.

Because *VLab* is from Germany, the manufacture quality of the hardware is excellent – and so is the design. Discrete components tidily arranged on a half height board (it needs this

to fit into an A3000). It looks reliable, and it is reliable. Because it's small it's easier to fit than bigger boards, an important consideration if you're all fingers and thumbs. Having spaced components means that it's easier for the manufacturers to repair too, if it ever does go wrong; but look, this is the sort of hardware that should last a lifetime.

"Yeah, O.K. Pat, but how does it work?"

On the back of *VLab* are two phono connectors – if you don't know what a phono connector looks like, that's the type used for the left and right sound connectors on the Amiga. So have a peak.

APPLICATIONS

Who will buy *VLab*? Obviously the main people who will use *VLab* are those involved in CDTV and multimedia development. CD titles so far have featured digitised pictures ranging in quality from the naff to the completely naff. With a decent frame grabber that doesn't cost an arm and a leg, we can expect better in the future.

If you're in the 24-bit graphics market, then has a number of distinct advantages over other frame grabbers. Although slow at saving 24-bit pictures (it takes a few minutes even with a hard drive), *VLab* can display 24-bit images directly through a Harlequin card fitted to the computer. So you don't have to save the pictures and load them again to make sure they're not messed up.

Another area where *VLab* is the digitiser of choice is in cross graphics work. Not only can *VLab* save files in all of the standard graphics modes, but it can also save in 128 and 256 colour modes. If you want a digitiser with this feature it normally cost three times the price or more of *VLab*.

Although the Amiga cannot normally display high-resolution pictures with this number of colours without fancy programming (ever seen the shareware utility *HamLab*?) plenty of other more expensive systems can. Mind you, to convert 256 colour IFFs into IBM PCX or Mac PICT formats you will need an image processor like *Art Department Professional* from ASDG.

FRONTEND

These three windows are the core of VLab.

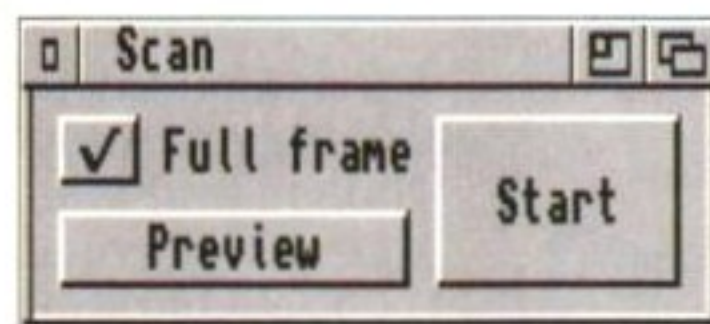

Scan is for reading the video information into VLab's frame buffer - the preview button rapidly gives a black-and-white image.

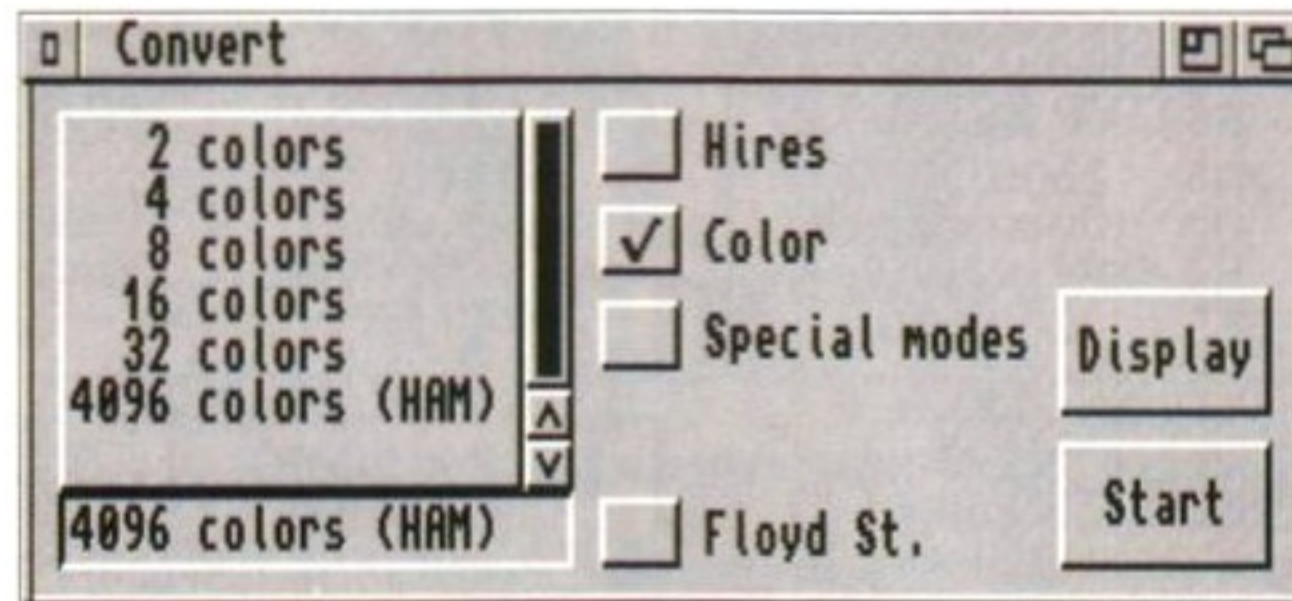

Convert is for rendering the video picture into an Amiga screen mode. Just click on that Start button.

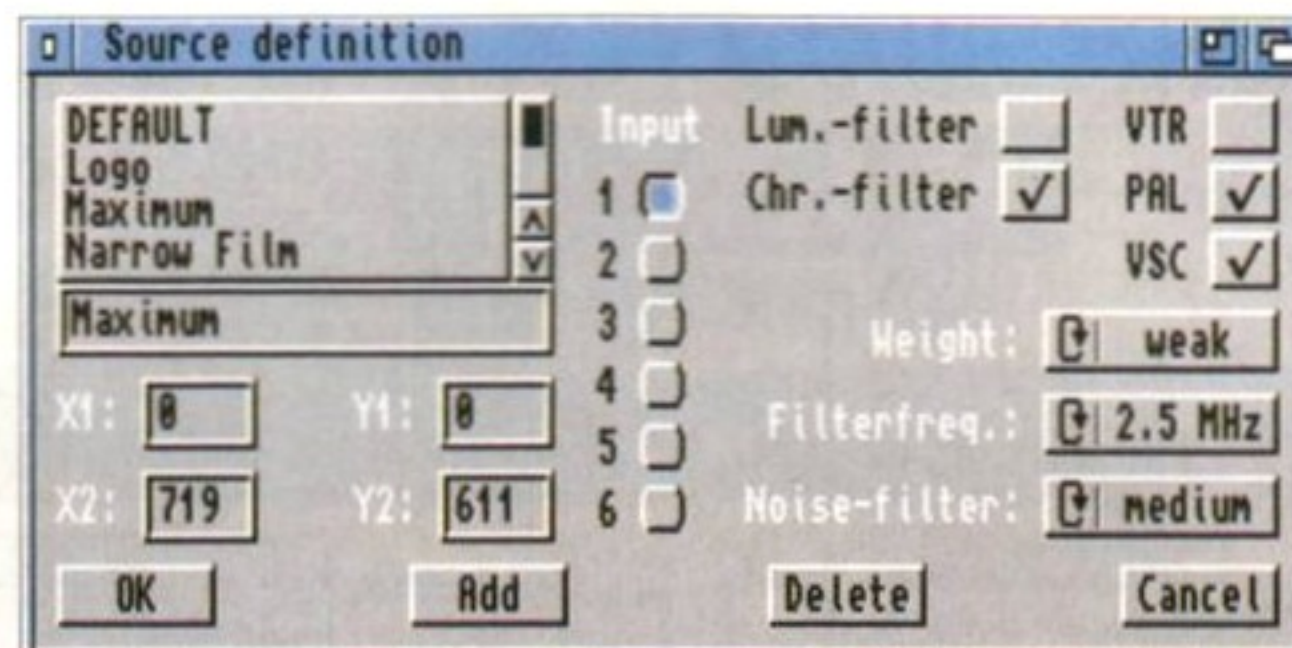

Source definition is for tweaking VLab's performance. It lets you change things like the area to be grabbed, how soft or strong the filters are, and which video port (1-6) you want to grab from. These choices can be saved for quick loading later.

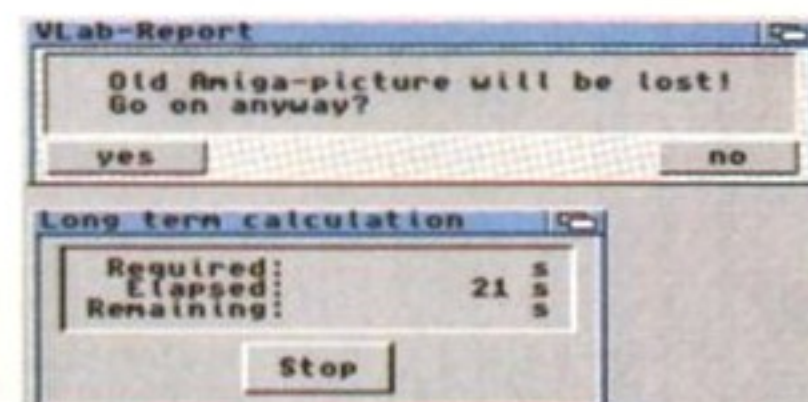

Here are only two of VLab's many warning messages. The first is pretty simple, just reminding you to save data as you create it. The second is a time box for when VLab is tied up calculating information - notice that it doesn't always give the time remaining or the elapsed time - a shame.

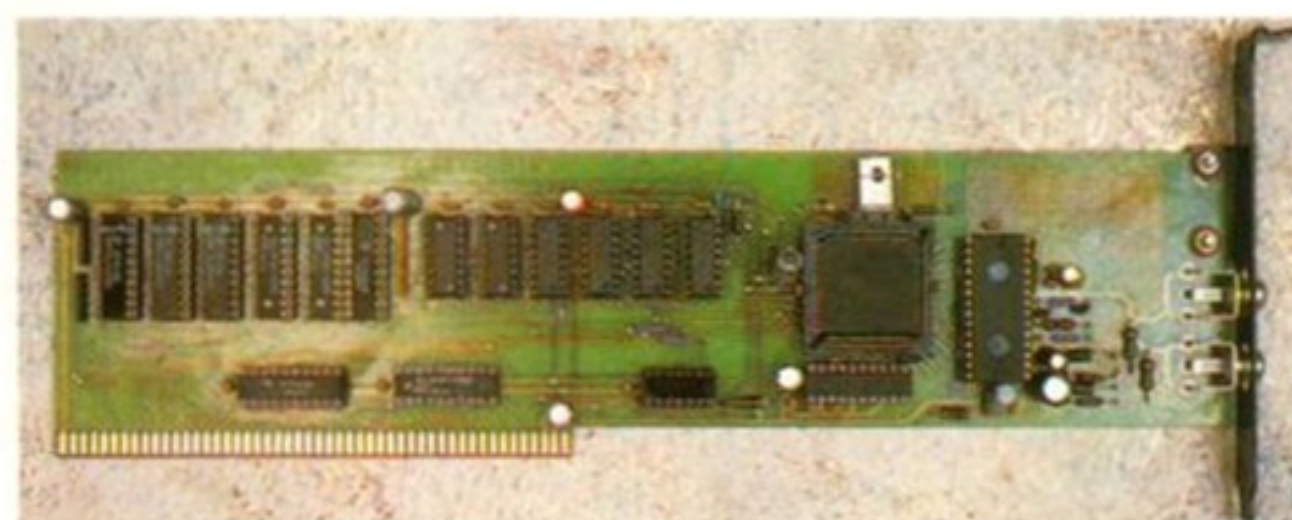

This image is really too small to give a real impression of the build quality, but you can at least get a general idea of the board's dimensions and layout. I mean, we could have printed the digitised piccies this small with a really big picture of the board. Joking apart, do you really give a monkey's what it looks like? I think not.

and the results are very good in a subtle way - but why does it double or quadruple the time to create the Amiga picture? I can't recall seeing a program with a slower F-S facility. Not much of a fault but it's there.

Apart from that, VLab's software is brilliant - friendly and very competent. You can start grabbing and making pictures within minutes, of turning the machine on. Not only does it need Workbench 2, but it uses its facilities to the full.

As you begin to get acquainted with the program side of VLab, you soon discover that the menus contain a number of really good features. You can easily modify the area being grabbed, both in offset and also in area. For most people the limit of 720 by 612 should easily be enough.

To help grab exactly the right frame from a video, an on-screen preview image is displayed on the screen. This is a small black-and-white window showing roughly what the video recorder is playing - but be warned, it's a bit rough and ready. Assuming you are familiar with the video material you are grabbing from, it's not too much trouble.

The monitor can be set to play all the time, or shut down when VLab has a lot of mathematical conversion work to do. The monitor is not a gimmick, but it does seem a bit trivial until you master its idiosyncrasies.

Other features: you can set VLab to deal with the appalling synchronisation quality of most home video recorders very easily. You can also set filters up, to suppress signal noise and get the best quality grabs. The only thing missing is a colour separation facility so that you can tweak the colour levels (a lot of videos bleed red and have very dull blues). But that can be accomplished by separate software like paint programs and image processors.

It's early days and only the first version, but VLab does look a very desirable and worthy product. It provides the facilities of more expensive products; gives better quality at grabbing due to its technical superiority; and it's really fun to use too! With the software's few rough edges smoothed I would expect VLab to be the digitiser of choice for all those who have a capable machine.

VLab V1.0

SPEED ●●●●
Generally quite good, but it's a difficult task - don't expect instant results though.

DOCUMENTATION ●●●●
Assuming a reasonable translation, a thick technical index with a small bit for the end user.

ACCESSIBILITY ●●●●●
Easy to work with, you can turn off the warnings and messages when you're competent enough.

FEATURES ●●●●●
Doesn't try to be too complicated, and everything that there is has a purpose.

VALUE ●●●●●
A frame grabber at roughly two thirds the price? Sounds good enough to me!

88%

You connect either of these to a video source, the 'video out' connector of a video recorder or camcorder. If you want, you can feed different signals into the connectors, and grab from either. Also, three VLab boards can be plugged into one Amiga, so you could have up to six different video sources available without fiddling around with any cables.

After that, just switch your machine on, boot up the supplied floppy (which is easy to install on a hard drive with Workbench 2), start the tape, and grab your picture into the frame buffer - this takes but a moment.

You can convert this composite YUV data into any standard Amiga IFF format, from between two to 4,096 colours in low resolution, and two to 16 colours in high resolution. The conversion process takes between one minute and an hour, depending on the resolution and whether or not you want Floyd Steinberg dithering.

After that, save the picture to disk as an IFF; VLab can also save 24-bit 'truecolour' files, and it's own YUV composite video files if you can't decide what resolution to convert the image to. VLab can only load these YUV files - it can't load standard IFF picture files or 24 bit 'truecolour' files.

The only annoying thing about the software is the appalling slowness of the F-S shading. All right, so it's not that important

**COMMODORE
1084S or 5 STEREO
MONITOR**
Including FREE lead
ONLY £219.00

**PHILIPS 8833 MK II
STEREO MONITOR**
Including
Free Lead
ONLY £219.00

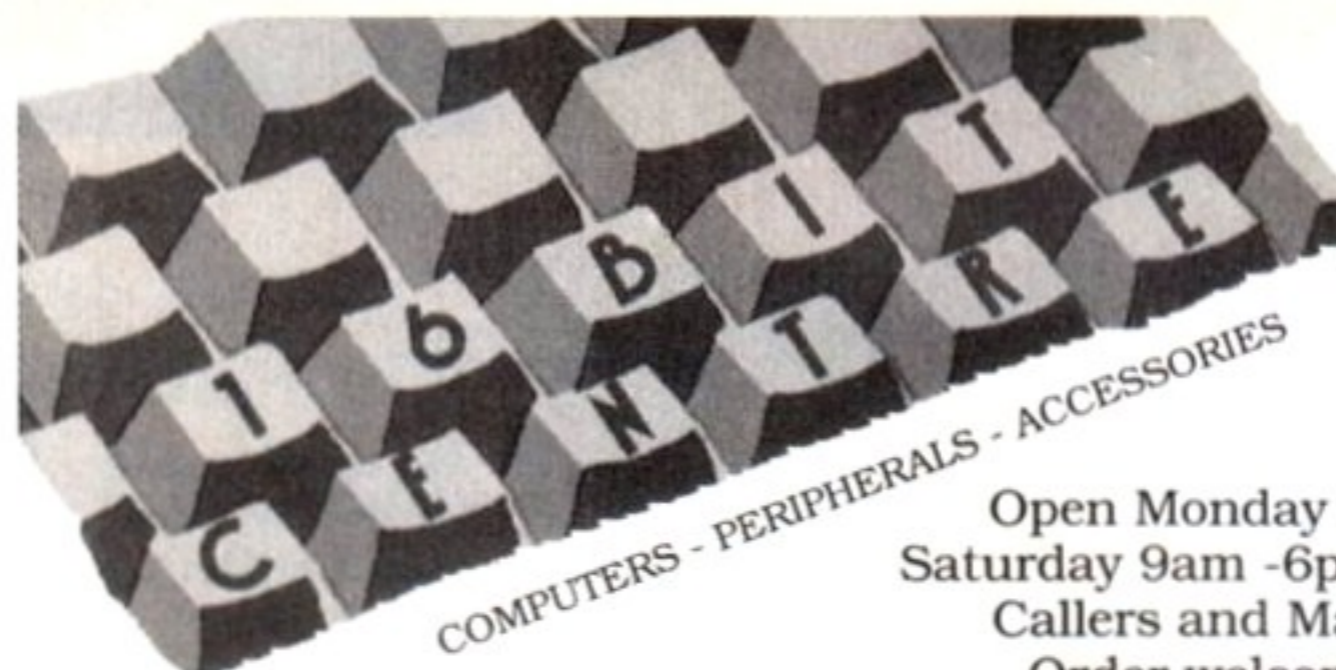

**KCS POWERBOARD
PC Emulator
For Amiga A500**
ONLY £179.00

**AT ONCE AMIGA
PC 286 AT EMULATOR
FOR A500**
ONLY £159.00

Open Monday to
Saturday 9am -6pm
Callers and Mail
Order welcome
Easy parking

HARD DRIVES

240 MEGS AVAILABLE ON ALL DRIVES
EG 1500 £689.00, A500 £729.00

GVP SERIES II 1500/2000 52Mb Quantum Space for 8Mb RAM £265.00	GVP SERIES II 1500/2000 105Mb Quantum Space for 8Mb RAM £389.00	GVP SERIES II 1500/2000 120Mb Quantum Space for 8Mb RAM £409.00	GVP SERIES II A500 52Mb Quantum Space for 8Mb RAM £349.00	GVP SERIES II A500 105Mb Quantum Space for 8Mb RAM £449.00	GVP SERIES II A500 120Mb Quantum Space for 8Mb RAM £499.00
---	--	--	--	---	---

AMIGA A500 FUN PACK

Amiga A500 Plus, Mouse, Modulator, Manuals, Workbench, Joystick, Disk Box,
10 Disks, Dust Cover, Dpaint III, 1Mb RAM, PLUS 13 GAMES Lemmings,
Simpsons, Captain Planet, Safari Guns, Bubble Ghost, Tin Tin, Purple Saturn Day,
Jumping Jackson, Hostages, Bobo, Krypton Egg, Shuffle Puck Cafe,
ONLY £399.00 inc VAT

SUPRA 500XP 52Mb Quantum Space for 8Mb RAM with 1Mb free £319.00	SUPRA 500XP 105Mb Quantum Space for 8Mb RAM with 1Mb free £429.00	SUPRA 500XP 120Mb Quantum Space for 8Mb RAM with 1Mb free £479.00
--	---	---

A500 CARTOON CLASSICS Only £319.00

SOFTWARE

DELUXE PAINT II £5.00	PIXEL 3D V2 £79.00
AMOS + EXTRAS DISK £32.00	QUARTERBACK £27.00
BROADCAST TITLER II £149.00	PRO-WRITE V3.2 £69.00
ULTIMATE DEMO MAKER £99.00	X CAD 3D £269.00
DIGIVIEW MEDIA STATION £105.00	PHOTON PAINT 2 £25.00
LATTICE C V5.10 £149.00	FINAL COPY (NEW) £39.00
PAGESETTER V2 £42.00	VIDEO EFFECTS 3D £109.00
PAGESTREAM V2.2 £122.00	DOS 2 DOS £28.00
PAGESTREAM FONTS £49.00	Q/BACK TOOLS £45.00
TV TEXT PRO £79.00	WORDWORTH £72.00
CROSS-DOS £19.00	SUPERJAM £85.00
SCENERY ANIMATOR £53.00	REAL 3D BEGINNERS £99.00
HITACHI VIDEO CAMERA. Ideal for use with DigiView £199.00	
PEN PAL, Excellent easy to use word processor £53.00	
IMAGINE 3D V2.0 Animations & ray-tracing £189.00	
ART DEPARTMENT PROFESSIONAL V2.05 £119.00	
ALL IN ONE, Word Pro, Midi Music, Paint, 3 games c/w video £115.00	
VIDEO EASE, Video titling package £35.00	
BARS + PIPES PROFESSIONAL £189.00	
AMOS COMPILER, Compile your Amos programs £23.00	
THE WORKS PLATINUM. Integrated package £45.00	
PRESENTATION MASTER £159.00	
VISIONARY Adventure creation language £53.00	
WALT DISNEY ANIMATION STUDIO £65.00	
REAL 3D TURBO/PROFESSIONAL £269.00	
PROFESSIONAL PAGE V2.1 (new) with tutorial video £125.00	

HARDWARE

386/20 AT Bridgeboard For 1500/2000 £469.00
ROM V2.04 AND ECS DENISE NOW IN STOCK each £37.00
ROM V2.04 Upgrade Kit £89.00
DCTV 24 bit colour graphics £469.00
AUDIO ENGINEER 2 PLUS sampling hardware & software £174.00
SOPHUS S5 Stereo sound sampling hardware/software £49.00
AMIGA COMPATIBLE DISK DRIVE on/off & through port £57.50
QTEC MOUSE high quality replacement mouse £22.50
SOUND MASTER Stereo sound sampling hardware/software £105.00
NAKSHA SCANNER Excellent scanning quality £105.00
TV TUNER for Philips and Commodore monitors £79.00

PRINTERS

STAR LC-24/200 COLOUR inc. free lead £269.00
STAR LC200 9 pin colour inc. free lead £189.00
STAR LASER 4 high quality laser printer inc. free lead £679.00
CITIZEN SWIFT 24E 24 pin colour printer inc free lead £269.00
CITIZEN 224 COLOUR 24 pin colour printer inc free lead £239.00
CITIZEN SWIFT 9 COLOUR 9 pin colour printer inc free lead £189.00
CANON BJ10 EX bubble jet printer inc free lead £239.00
STARJET SJ48 bubble jet printer inc free lead £225.00
HP DESKJET 500 inkjet inc free lead £349.00
HP DESKJET 500 COLOUR inkjet inc free lead £539.00
CITIZEN 224 MONO 24 pin mono printer inc free lead £209.00

MEMORY

SUPRA RX500, 8Mb board for A500 with 1Mb £95.00
SUPRA RX500, 8Mb board for A500 with 2Mb £119.00
SUPRA RX500, 8Mb board for A500 with 4Mb £199.00
SUPRA RX500, 8Mb board for A500 with 8Mb £299.00
MICROBOTICS 8Mb Ram Board for A1500/B2000 with 2Mb £155.00
EXTRA 2 Mb OF RAM FOR MICROBOTICS £75.00
A500 512K RAM WITH CLOCK AND SWITCH £29.00
A500 PLUS 1MB RAM UPGRADE £39.00
ROM 1.3/2.0 Sharer With Switch £17.00
ROM 1.3/V 2.0 Sharer by Keyboard reset £29.00

MODEMS & FAX

B/Bandit 2400 Modem, V21, V22Bis & MNP 5 (speeds up to 4800) £105.00
Supra 2400 Plus, MNP5 & V42 Bis (speeds up to 9600) £165.00
Supra 9600 Modem. Speeds up to 38000 £399.00
Supra 2400 Plus Internal Modem for A1500/B2000 £159.00

Call for latest Supra Amiga Fax/Modems new in

AMIGA A1500

The A1500 inc. Philips or CBM 1084s or 5 monitor, Twin drives, Dpaint3,
The Works Platinum, Home Accounts, 3 Games + Joystick
ONLY £739.00

AMIGA A500 part exchange available - please phone

ACCELERATORS

Microbotics Accelerator VXL-30, 25MHz £222.00
Microbotics Accelerator VXL-30, 40MHz £351.00
68882 Floating Point Co-processor for VXL-30 £132.00
GVP 68030 25MHZ WITH 1 MEG RAM £549.00
GVP 68030 40MHZ WITH 4 MEGS RAM £959.00
GVP 68030 50MHZ WITH 4 MEGS RAM £1299.00

HOW TO ORDER:
Either call our number
below with your credit
card details, or send
cheque/PO or credit
card details to our
address. Cheques made
payable to
THE 16 BIT CENTRE
Prices subject to change without
notification.

All prices include VAT and Courier Service

16 BIT CENTRE

Units 15-17,
Lancashire Fittings Science Village
Claro Road, Harrogate HG1 4AF

Tel (0423) 531822/526322

**EXTENDED WARRANTY
AND MAINTENANCE
CONTRACTS AVAILABLE
ON ALL ITEMS. PLEASE
CALL FOR FURTHER
DETAILS**





DISKS

from 31p

BULK DISKS DISKBOXES

	3.5 DS/DD	Capacity	Size	
25	10.99	40	3.5	3.99
50	20.50	80	3.5	4.99
100	36.99	120	3.5	6.49
250	84.99			
500	164.99			
1000	317.99			

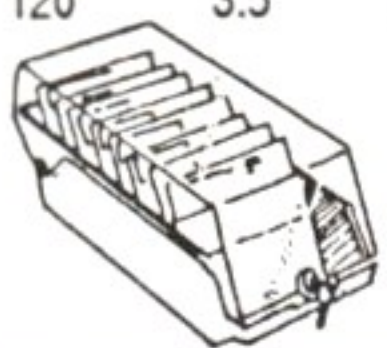

* OUR DISKS ARE FULLY GUARANTEED AND ARE COMPLETE WITH LABELS.

>>> SPECIAL <<<
 120 Capacity Box & 100
 3.5 DS/DD Disks **£42.49**

PAPER - TOP QUALITY

Fanfold with Micro Perfs.	1000	2000
11x9.5 60gsm	7.99	13.99
11.66x9.25(A4) 70gsm	10.49	18.49
11.66x9.25(A4) 80gsm	11.99	20.49
11.66x9.25(A4) 90gsm	13.99	23.99



**SNAP
COMPUTER
SUPPLIES LTD**

**HOTLINE
0703 457111
Fax: 0703 457222**

RIBBONS - POST FREE

Top Quality compatible brands

	2 off	4 off
Citizen 120D/LSP10/124D Swift 24	2.50	2.30
Citizen Swift 24 Colour	15.00 ea	
Epson FX/MX/RX80/FX800/LX800	3.20	3.00
Epson LX80/86	2.00	1.80
Mannesman Tally	3.50	3.20
Panasonic KXP 1080/81/82/1123	2.90	2.70
Panasonic KXP 1124/1140 2.60	2.60	2.40
Star LC10 Mono	2.80	2.60
Star LC10-4 Colour	5.90	5.70
Star LC24-10	2.80	2.60
Star LC24-10 Colour	12.50 ea	
Star LC200	3.20	3.00
Star LC200 Colour	11.50 ea	
Star LC24-200	2.80	2.60
Star LC24-200 Colour	12.50 ea	

ACCESSORIES - POST FREE

Amiga External Drive	54.99
Amiga 512k Upgrade, Clock	23.99
Amiga 512k Upgrade, No Clock	21.99
Mouse Mat	2.99
Mouse Holder	2.99
2 Piece Universal Printer Stand	6.99
3.5 Disk Clean Kit	2.99
Roll 1000 3.5 Disk Labels	8.99

SNAP COMPUTER SUPPLIES Ltd. | All products are subject to availability - All prices include VAT.
 Unit 16, The Sidings, Hound Rd, Netley Abbey, Southampton. SO3 5QA | Please add £2.99 P & P for disks & boxes, £3.99 for paper. E.&O.E.

**NEW UNIQUE
ART TUTOR**

Fed up with gimmicky paint programs?
 Learn drawing, painting, design, cartooning,
 etc with ART TUTOR

Powerful, easy-to-use built-in
PAINT PROGRAM makes using the skills
 you learn easy.

Simply go through interactive
 tutorials, when ready drop down into the
 paint program, have a go, then pop back
 into the tutorial at the point you left it!

Hundreds of savable pictures (IFF)

Eleven tutorials

Only **£25** inc P&P from
CASTLESOFT
LEVENMOUTH BUSINESS CENTRE,
RIVERSIDE ROAD, LEVEN,
FIFE KY8 4LT
TEL. 0333 421243



FREE

**BRITAIN'S No1 Sound Sampling
 System "EVERY AMIGA OWNER
 SHOULD HAVE IT" - Amiga Format**



TECHNOSOUND

**Worth £39.99 - FREE when you purchase any
 one of the following:**



- ROMBO**
- Complete Colour Solution ..£149.99
 - Vidi Amiga£119.99
 - RGB Colour Splitter£79.95
 - Take 2 Animation£99.95

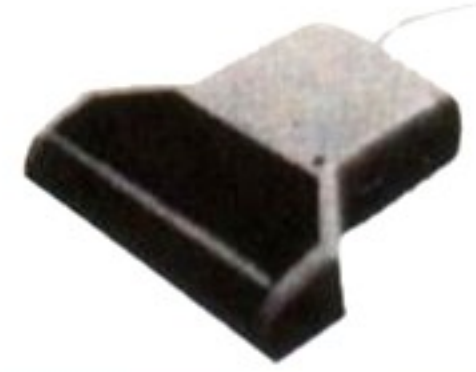

**DAaTA
 SCAN
 Pro GS
 V2.02** **Pandaal hand
 scanner with latest
 greyscale software
 £129.99**

£7 OFF **TECHNOSOUND TURBO WHEN
 PURCHASED SEPARATELY**
RRP £39.99 £32.99 (INCLUDES AUDIO LEADS)

FIRECREST DISTRIBUTION
119 UNDERHILL CRESCENT,
ABERGAVENTNY, GWENT NP7 6DU.
TEL (0873) 850028

ADD £2.00 P&P



AMIGA FORMAT

JUNE 1992

There's one area of Amiga graphics which has been much ignored, and that's the potential for high-quality illustration provided by structured drawing. Now that could change, as **Paul Wilson** discovers...

Expert Draw

Structured Drawing ■ £69.95 ■ HB Marketing

ASTONISHINGLY, THERE'S ONE area of creative use in which the Amiga has never really been given its due, and that's in what's commonly called 'structured drawing'. We've got paint packages aplenty and video titlers coming out of our ears, covering a range of complexity and to suit a range of pockets: but structured drawing remains neglected.

For the uninitiated, structured drawing is the high-quality professional solution to getting clean, sharp illustrations out of a computer. It works in a very similar way to outline fonts in DTP, based around drawing curved or straight lines to create objects, then filling them in with colour.

The important thing is that all pictures are stored as mathematical data rather than a bitmap, so any part of your picture can be picked out and changed at any time even if you load it from disk long after the picture was created. It also means that you can make an image as big as you wish without the outlines of the picture getting all 'jaggy' and that your pictures will always print at the highest possible quality that your printer can provide. No nasty pixels, you see!

Structured drawing is the natural partner for DTP, giving the ideal way for professional, high-quality illustrations for the complete page. The quantity and quality of DTP programs around now (see last issue's reviews of *PageStream 2.2* and *Professional Page 3*) makes it particularly surprising that the structured drawing area has been so much ignored.

Until now, only Gold Disk, makers of *Professional Page*, have competed seriously in this area with their *Professional Draw* package. Good though *ProDraw* is, it's expensive and not completely satisfactory. New Horizons entered the arena with their disappointing *Design Works*, which couldn't be excused its inadequacies by the fact that it was supposed to be 'entry-level'.

Expert Draw looks as if it could make a big difference here. Translated from the original German by importers HB Marketing, it is fully-featured enough for professional use and yet at the same time it's not horribly expensive. It could even be cheap enough to be a good starting-point for exploration by newcomers, opening up a new area of Amiga use. Can it live up to expectations? Read on...

EXPERT DRAWING is available from HB Marketing: 0753 686000

All that you would expect from a structured drawing package is here, especially the ability to distort and shade, as done with the text in this image. Parts of the image can be selected independently and sized or reshaped at will, with no loss of quality.

EXPERT DRAW is available from HB Marketing 0753 686000



The program loads at a reasonable speed from floppy, and noticeably faster from hard drive, but once it has loaded it has the advantage that it hardly accesses the disk at all, except when you change a font. First impressions are that it looks very similar to a DTP package: most of the screen is a blank page and it has a toolbox on the right-hand side which can be moved around, and its position saved as a new default setting.

Working from the toolbox and the menus, most of what you'll want to do is more or less self-explanatory, but when you get stuck the in-depth 47 page-manual has a lot packed into it, especially when you consider how much the program has to offer you, and is generally pretty good.

The toolbox contains standard tools for drawing all manner of lines and shapes, most important of which are the 'bezier curves' which allow you to drag a shape around to produce smooth, fluid curves.

Other handy tools allow you to add text, fill in areas with colour and rotate objects, as well as deleting unwanted shapes or lines and undoing your mistakes. Also incredibly important are the tools that let you add points to a shape (so that you can drag them out into a

new shape) and close up a polygon so that you can colour-fill it without the colour bleeding. Once a shape or group of shapes is drawn, you can select a tool which allows you to reshape and resize them en masse, although unlike distortion (see below) this keeps the proportions intact to some extent.

First operation with a new drawing is to set your page size. You can then choose to work on a grid, making it easier to align objects, and zoom in at variable levels of magnification on your drawing. There are three ways of viewing your picture: Wireframe shows only outlines and is the quickest for working with; Show Tangents adds in the control points for you to reshape objects; and Black and White gives a full shaded or coloured image.

When you're drawing, a number of different requesters can be pulled up to alter the attributes of the tools that you are using: changing the angle by which rotations are made, altering which font is being used, changing the thickness of lines and colour of fills, and so on. All of these are straightforward to use and effective.

One thing that is very important in a structured drawing program is that you must be

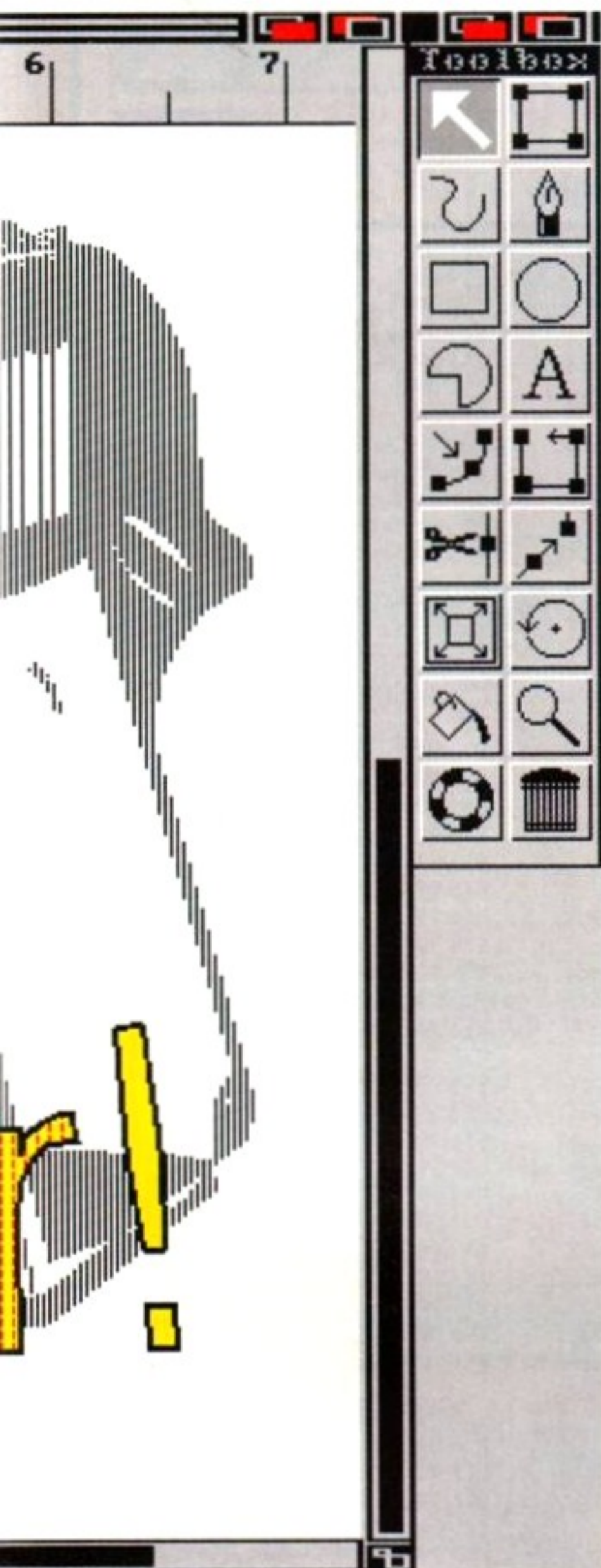

A PARTICULAR SPECIALITY

While *Expert Draw* has all that you would expect from a good structured drawing package, it also has a number of extra goodies tucked away in the Specials menu. Also available here is 'Vector Trace', which loads IFF bitmaps and changes them into structured pictures, but we'll just take a look at the others...

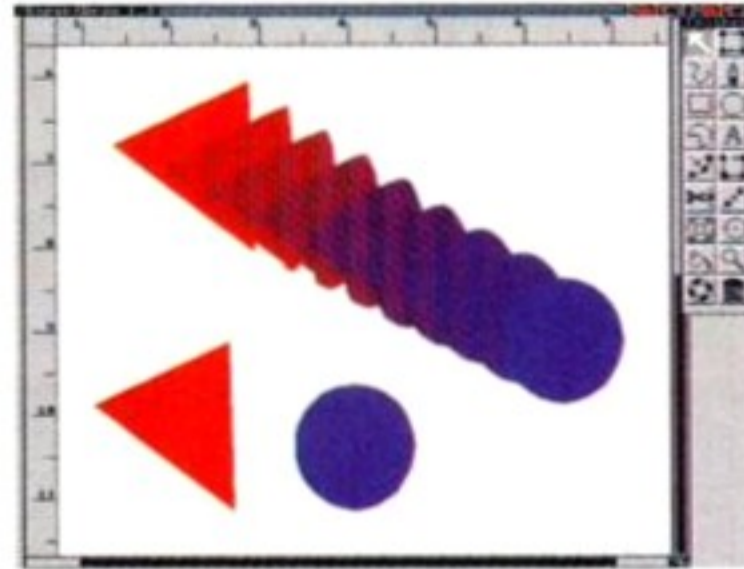

The Metamorphosis feature gives you the ability to transform from one shape to another. The only limitation is that the two shapes must be made up of basically one set of linked lines: so transforming a letter 'V' to an

'M' is quite easy, but the program can't do 'V' to 'O', because an outline O is made up of two circles. Notice too that the metamorphosis also blends the colours of your inbetween steps from that of your start object to that of your end object.



One really nice feature of the program is its ability to wrap text on to a curved shape, as you see here with the circle. Distort can be used to squeeze any object around, either using a requester to type in

values (which can help give an excellent perspective effect) or to stretch stuff around freehand.



Color Blend produces a range of colours from the first object in your set to the last. First we have to set the first object to a different colour, like the blue D here. Then we select the whole set, use the Colour Blend menu

option, and we're away. Notice that the colours used are hatched (a blend of two colours) because they are just an on-screen representation, working with 16 colours. The real colours represented by the screen can be set through the full range of RGB colours, or as CMYK process-separated colours, as used in the print industry.



As well as repeating an object, this allows you to set angles of rotation in three axes as well as shifting the duplicates around the page. What this means in practice is that you can perform all sorts of whizzy effects, like perspectives shift and amazing Spirograph-style patterns. Very neat.

like perspectives shift and amazing Spirograph-style patterns. Very neat.

able to group objects together and move or edit them as one. *Expert Draw* refers to such groups as compound objects and allows you to create them and later separate them into their original objects.

When you add text, the structured outline fonts are treated as objects too, so you can resize and reshape them at will, which makes the program immensely useful as a way of styling type for DTP programs.

In typical professional style, load and save menus are referred to as 'Import' and 'Export'. *Expert Draw* will load in three formats: from the older Aegis Draw program; from Clip, which basically means the standard *Professional Draw* format used by all DTP structured clip art; and Vector Trace, a format used by the program's built-in Trace feature to convert bitmapped images. It can save as EPS Postscript files, in Clip format, or save the screen as an IFF for use in a normal Amiga paint program.

Four special features are particularly impressive. Metamorphise will change one object into another, which is quite rather nifty. Colour Blend gives your fills those spectacular graduated ranges of colour that computer artwork specialises in, a bit like airbrush work.

Duplication allows you to simultaneously rotate and resize an object. Finally Distortion allows you to select an object and twist it about to create interesting new shapes.

Generally, the program is simple and enjoyable to use and it is effective and quick in operation. There are only a couple of minor niggles that let it down.

It comes with two fonts, Times and Helvetica, but these are both in its own format and incompatible with other outline fonts. HB Marketing will supply you with a program to convert Soft Logik's *PageStream* fonts for use in *Expert Draw*, which will increase the choice considerably, but at a cost of around £40 this has to make *Expert Draw*'s low price seem less of a bargain.

One inevitable problem when you are working on a complex picture is that the screen insists on updating when you do even a very simple operation, like selecting an object. Sitting and waiting for the screen to redraw on these occasions is a real irritation, so some way of avoiding a redraw when no object's position has been changed would be useful.

Although you can resize as many objects as you want at the same time – even your whole picture – you cannot resize compound objects in colour. It loses its colour and unfortunately there seems to be no way of making the picture colour again, except filling each individual box again.

While there is an enormous range of keyboard shortcuts to make the selection of a new drawing operation easier, it's annoying that too many of these are obscure and ignore the established conventions adopted now by so many DTP programs. A shame.

Despite these irritations, in terms of all the most important factors – features, presentation and speed of operation – *Expert Draw* is a definite step in the right direction for structured drawing on the Amiga. Font compatibility apart, it sets new targets for *Professional Draw* which is soon to appear in its third version. And the price means that even complete novices can give structured drawing a bash. On the whole, this has to receive an enthusiastic recommendation. ☺

Expert Draw

SPEED

●●●●●
Could have been slightly faster with the screen updates, apart from that it's impressively rapid.

DOCUMENTATION

●●●●●
Serves its purpose if tending to jargon, although the program is fairly self explanatory.

ACCESSIBILITY

●●●●●
Reasonably straightforward and easy to use, the keyboard short cuts were a tad disappointing.

FEATURES

●●●●●
The fonts supplied are a bit of a let down, but special drawing operations are remarkable.

VALUE

●●●●●
Good value for money, but the price of the font converter takes the edge off in practice.



86%

CITIZEN

ALWAYS A GOOD IDEA

Silica presents some great offers on the award winning range of high quality matrix printers from Citizen. Each Citizen printer is built in the UK to exacting standards, ensuring superb reliability and output. Our confidence in Citizen's quality is such that we are pleased to include a 2 year guarantee with every printer. Plus, if you buy a Citizen printer (not inkjet) from us, we will give you the Silica Printer Starter Kit (worth £29.38), **FREE OF CHARGE!**

- FREE DELIVERY**
Next Day - Anywhere in the UK mainland
- FREE STARTER KIT**
Worth £29.38 - With every Citizen printer (excluding inkjet) from Silica
- 2 YEAR WARRANTY**
Silica offer a 2 year warranty (including the printer head) with every Citizen printer from Silica.
- WINDOWS 3.0**
Free Windows 3.0 driver
Included with the Silica Starter Kit
- FREE COLOUR KIT**
With every Produt 9 and Swift 24e printer.
- FREE HELPLINE**
Technical support helpline open during office hours.
- MADE IN THE UK**
Citizen printers are manufactured to high standards.

DOT MATRIX PRINTERS

INK JET AND NOTEBOOK

LOW PRICE 9 PIN PRINTER



- 144 CPS**
- 80 COLUMN**
- Citizen 120D+ - 9 pin - 80 column
- 144cps Draft, 30cps NLQ
- 4K Printer Buffer + 2 Fonts
- Parallel or Serial Interface
- Graphics Resolution: 240 x 240dpi
- Epson and IBM Emulation
- Pull tractor & bottom feed
- FREE Silica Printer Starter Kit

£115
+VAT= £135.13 ref: PRI 2120

RRP £199
SILICA STARTER KIT £25
TOTAL VALUE: £224
SAVING: £109
SILICA PRICE: £115

The Citizen 120D printer comes supplied with a parallel interface as standard. If you require a serial interface instead please state ref. PRI 2125 when placing your order with Silica.

9 PIN PRINTERS



- 300 CPS**
- 80 COLUMN**
- Citizen Produt 9 - 9 pin - 80 column
- 300cps Draft, 60cps NLQ
- 8K Printer Buffer + 3 Fonts
- Parallel Interface
- Graphics Resolution: 240 x 240dpi
- Epson and IBM Emulation
- FREE Colour Kit
- FREE Silica Printer Starter Kit

RRP £189
COLOUR KIT £41
SILICA STARTER KIT £25
TOTAL VALUE: £255
SAVING: £66
SILICA PRICE: £189

£189
+VAT= £222.08 ref: PRI 2319



- 192 CPS**
- 80 COLUMN**
- Citizen Swift 9 - 9 pin - 80 column
- 192cps Draft, 48cps NLQ
- 8K Printer Buffer + 3 Fonts
- Parallel Interface
- Graphics Resolution: 240 x 240dpi
- Epson and IBM Emulation
- Colour Option available
- FREE Silica Printer Starter Kit

RRP £229
SILICA STARTER KIT £25
TOTAL VALUE: £254
SAVING: £75
SILICA PRICE: £189

£189
+VAT= £222.08 ref: PRI 2209



- 192 CPS**
- 136 COLUMN**
- Citizen Swift 9x - 9 pin - 136 column
- 192cps Draft, 48cps NLQ
- 8K Printer Buffer + 3 Fonts
- Parallel Interface
- Graphics Resolution: 240 x 240dpi
- Epson and IBM Emulation
- Colour Option available
- FREE Silica Printer Starter Kit

RRP £329
SILICA STARTER KIT £25
TOTAL VALUE: £354
SAVING: £105
SILICA PRICE: £249

£249
+VAT= £292.58 ref: PRI 2309

24 PIN PRINTER



- NEW! LIMITED OFFER**
- Citizen Swift 24e - 24 pin - 80 column
- 216cps Draft, 72cps LQ
- 8K Printer Buffer + 6 Fonts
- Parallel Interface
- Graphics Resolution: 360 x 360dpi
- Epson, IBM & NEC P6 Emulation
- FREE Colour Kit
- FREE Silica Printer Starter Kit
- FREE Lotus Ami 1.2 Word Processor and DTP package
- FREE Adobe Type Manager V1.15

RRP £369
COLOUR KIT £38
SILICA STARTER KIT £25
LOTUS AMI 1.2 WP/DTP PACKAGE £95
ADOBE TYPE MANAGER V1.15 (Fonts) £79
TOTAL VALUE: £606
SAVING: £337
SILICA PRICE: £269

£269
+VAT= £316.08 ref: PRI 2544



PRINTER + SOFTWARE + COLOUR

24 PIN PRINTERS



- 192 CPS**
- 80 COLUMN**
- Citizen 224 - 24 pin - 80 column
- 192cps Draft, 64cps LQ
- 8K Printer Buffer + 4 Fonts
- Parallel Interface
- Graphics Resolution: 360 x 360dpi
- Epson and IBM Emulation
- Colour Option Available
- FREE Silica Printer Starter Kit

RRP £269
SILICA STARTER KIT £25
TOTAL VALUE: £294
SAVING: £95
SILICA PRICE: £199

£199
+VAT= £233.83 ref: PRI 2484



- 192 CPS**
- 136 COLUMN**
- Citizen Swift 24x - 24 pin - 136 column
- 192cps Draft, 64cps NLQ
- 8K Printer Buffer + 4 Fonts
- Parallel Interface
- Graphics Resolution: 360 x 360dpi
- Epson, IBM and NEC P6 Emulation
- Colour Option Available
- FREE Silica Printer Starter Kit

RRP £489
SILICA STARTER KIT £25
TOTAL VALUE: £514
SAVING: £165
SILICA PRICE: £349

£349
+VAT= £410.08 ref: PRI 2574

INKJET PRINTER



- 360 CPS**
- 80 COLUMN**
- Citizen Projiet - inkjet - 80 column
- 360cps Draft, 120cps NLQ
- 50 Nozzle Head - Whisper Quiet 47dB(A)
- 8K Printer Buffer + 3 Fonts
- Optional HP Compatible Font cards
- Parallel Interface
- Graphics Resolution: 300x300dpi
- HP Deskjet plus emulation

RRP £499
TOTAL VALUE: £496
SAVING: £137
SILICA PRICE: £359

£359
+VAT= £421.83 ref: PRI 2090

NOTEBOOK PRINTER



- 64 CPS**
- 80 COLUMN**
- Citizen PN48 Notebook Printer
- Non-impact Printing on Plain Paper
- 53cps LQ - 4K Buffer + 2 Fonts
- Rear and Bottom Paper Loading
- Parallel Interface
- Graphics Resolution: 360 x 360dpi
- Epson, IBM, NEC P6 & Citizen Emulation
- Powered From Mains, Battery or Car Adaptor
- FREE Silica Printer Starter Kit

RRP £325
SILICA STARTER KIT £25
TOTAL VALUE: £350
SAVING: £101
SILICA PRICE: £249

£249
+VAT= £292.58 ref: PRI 2100

FREE! STARTER KIT

WORTH £29.38

This starter kit will help you to get you up and running with your new Citizen dot matrix or notebook printer when you buy it from Silica Systems.

- 3 1/2" Disk - Amiga & ST Drivers
- 3 1/2" Disk - Driver for Windows 3
- 2 Metre Parallel Printer Cable
- 200 Sheets of Continuous Paper
- 100 Continuous Address Labels
- 5 Continuous Envelopes

FREE! CITIZEN PRINT MANAGER

WORTH £14.95

(LIMITED PERIOD ONLY)

The ultimate printer driver program for your Amiga, which dramatically enhances printed output. Provides drivers for all Citizen printers and replaces Amiga's normal printer preference system - printing is quicker, colours more vibrant, graphics less fuzzy. Easy to use. Print Manager is supplied with its own instruction manual. Main features include:

- Improved Image Smoothing
- Gamma/Colour Correction
- Image Scaling
- Colour Separation
- Reduces/Eliminates Banding



ACCESSORIES

SHEET FEEDERS

- PRA 1200 1200 £71.38
- PRA 1215 1240/224/Swift 9/24 £88.79
- PRA 1228 1240/224/Swift 9/24 £42.00

SERIAL INTERFACES

- PRA 1189 1200 £56.45
- PRA 1209 Swift 9/9x/1240/224 £32.25
- PRA 1709 Swift 24/24x/24e £26.38

32K MEMORY EXPN

- PRA 1753 1240/224/Swift 24 £13.10

PRINTER STAND

- PRA 1242 1240/224/Swift 9/24 £24.00
- PRA 1274 Swift 9x/24x £30.66

ORIGINAL RIBBONS

- RIB 3520 1200/Swift 9 Black £2.91
- RIB 3549 Swift 9/9x Black £7.15
- RIB 3524 1240/Swift 24 Black £4.70
- RIB 3806 224/Swift 9/24 Colour £15.62
- RIB 3248 PN48 Single Strike £3.61
- RIB 3248 PN48 Multi Strike £3.61

COLOUR KITS

- PRA 1236 224/Swift 9/24/24e £35.25
- PRA 1240 Swift 9x/24e £35.25

PN48 ACCESSORIES

- PRA 1148 PN48 Battery £31.70
- PRA 1155 PN48 Cable Extn. £ 7.9C
- PRA 1162 PN48 Car Adaptor £ 7.9C

Accessories prices inc. VAT & delivery

SILICA SYSTEMS OFFER YOU

- FREE OVERNIGHT DELIVERY:** On all hardware orders shipped in the UK mainland.
- TECHNICAL SUPPORT HELPLINE:** Team of technical experts at your service.
- PRICE MATCH:** We normally match competitors on a "Same product - Same price" basis.
- ESTABLISHED 12 YEARS:** Proven track record in professional computer sales.
- BUSINESS + EDUCATION + GOVERNMENT:** Volume discounts available for large orders.
- SHOWROOMS:** Demonstration and training facilities at our London & Sidcup branches.
- THE FULL STOCK RANGE:** All of your requirements from one supplier.
- FREE CATALOGUES:** Will be mailed to you with offers and software/peripheral details.
- PAYMENT:** By cash, cheque and all major credit cards.

Before you decide when to buy your new printer, we suggest you think very carefully about WHERE you buy it. Consider what it will be like a few months after you have made your purchase, when you may require additional peripherals or software, or help and advice. And, will the company you buy from contact you with details of new developments and products? At Silica Systems, we ensure that you will have nothing to worry about. We have been established for over 12 years and, with our unrivalled experience and expertise, we can now claim to meet our customers' requirements with an understanding which is second to none. But don't just take our word for it. Complete and return the coupon now for our latest Free literature and begin to experience the "Silica Systems Service".

MAIL ORDER HOTLINE
081-309 1111

SILICA SYSTEMS

MAIL ORDER: 1-4 The Mews, Hatherley Rd, Sidcup, Kent, DA14 4DX Tel: 081-309 1111
Order Lines Open: Mon-Sat 9.00am-6.00pm No late Night Opening Fax No: 081-308 0608

LONDON SHOP: 52 Tottenham Court Road, London, W1P 0BA Tel: 081-580 4000
Opening Hours: Mon-Sat 9.30am-6.00pm No late Night Opening Fax No: 071-323 4737

LONDON SHOP: Selfridges (1st Floor), Oxford Street, London, W1A 1AB Tel: 071-629 1234
Opening Hours: Mon-Sat 9.30am-6.00pm Late Night: Thursday until 8pm Extension: 3914

SIDCUP SHOP: 1-4 The Mews, Hatherley Rd, Sidcup, Kent, DA14 4DX Tel: 081-302 8811
Opening Hours: Mon-Sat 9.00am-5.30pm Late Night: Friday until 7pm Fax No: 081-309 0017

To: Silica Systems, Dept AMFOR-0692-55, 1-4 The Mews, Hatherley Rd, Sidcup, Kent, DA14 4DX

PLEASE SEND INFORMATION ON THE CITIZEN RANGE

Mr/Mrs/Miss/Ms: Initials: Surname:

Address:

Postcode:

Tel (Home): Tel (Work):

Company Name (if applicable):

Which computer(s), if any, do you own? 55F

Since it appeared last year, Impulse have been working hard upgrading and improving their 3D modelling and rendering masterpiece. Now all their efforts are gathered together in one vision.

It's second-time around for **Brian Larkman**.



Imagine 2

3D Modelling and Animation ■ £269 ■ Impulse

IMAGINE WAS ALWAYS graced with a profusion of editors and more ways of picking objects and points than an octopus had for picking his nose. At first sight not much seems to have changed. The interface has been given the 3D button treatment and coloured them amber; contrasting with the charcoal screen. All of the editors and most of the tools look the same. It is only when you compare the modelling interface with the old version that the extent of the changes becomes apparent. Editors that worked well before can now be carefully tuned so that every tool falls exactly to hand. This is the sort of upgrade that makes sense – not new tools but better tools.

The most important improvement to the interface is the addition of a 'button' strip across the bottom of the screen in all editors. Here text icons have been provided to control rotation, scaling and movement of selected objects and axes – previously only available as key presses. In addition, any frequently-used menu command can be 'iconised' via the Preferences editor, and placed on the button strip. This customisation is so easy to set up that buttons can be added and removed to suit particular jobs. For example, if you have built a simple model of a cow and want to add form and character with the Magnet tool, both this and the Magnet setup requester can be added to the strip making them readily available for quick changes of parameters.

Perhaps the worst new feature is the dreadful drop-shadowed font used for menu selections. The effect is that the menus look out of focus. Ugh! On the positive side though, most editors can now do a Quickrender in full colour so you can easily keep track of what an object or scene really looks like.

The Forms editor allows objects to be constructed using front and side views with a cross-sectional (slice) view. Originally, only a single cross-section was allowed. Now, any 'slice' can be made editable and, much like the other views, several levels of symmetry can then be applied. Once several slices have been changed, all of the in-between slices will reflect a gradual transition from one shape to the other.

For example, imagine eight circular disks of various sizes arranged horizontally one above the other so that from either side the overall impression is a sphere. If the top disk

Fog Length (entered in the Attributes requester) determines the distance at which an object is half obscured by fog. As you can see here there is far more atmosphere; the clean and smart look of most computer graphics has been avoided. The inset shows that there are a few problems when rendering objects in fog (blocks of colour behind the cow) but these should soon be overcome. The 'quilt' look is obtained by selecting Randomise Colours in the Attributes Requester.

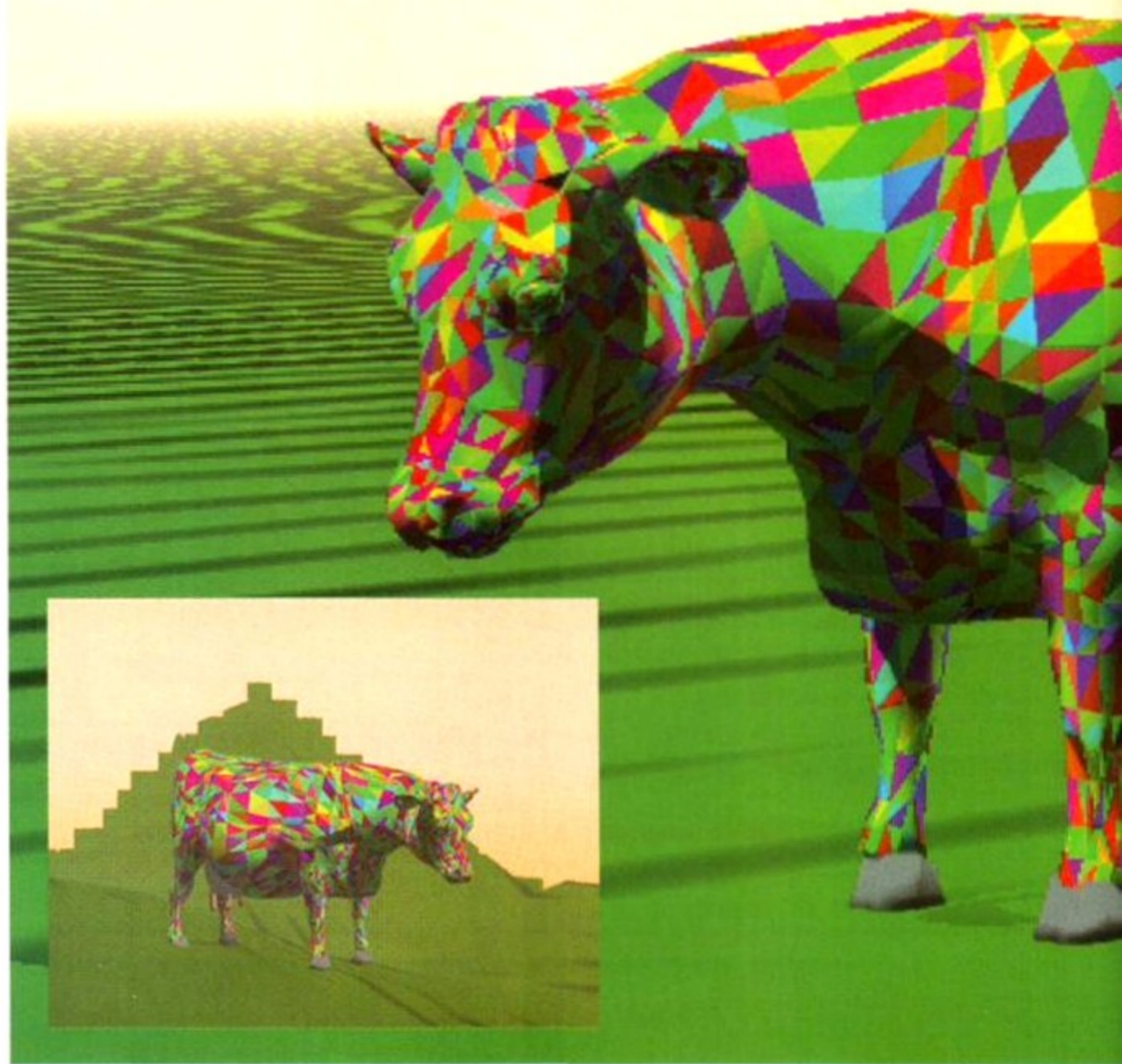

is made a key slice and edited to a star shape, all the others will change profile so that the sphere looks fluted from top to bottom. If the centre disk is changed back to a circle, the in-between disks will show a profile transition from star to circle. If the bottom disk is edited to a square, the transition from centre to bottom will be circle to square. What makes the tool so versatile is that both the side views can be edited, and symmetry does not have to be maintained, so some exotic natural forms can be produced. The possibilities are endless.

Once a Form has been designed it can be saved for later Form editing or loaded into the Detail editor for point editing. The Detail editor is more versatile than any editor in any 3D package. For the experienced user the package is very powerful and well worth the effort required to master it. Using *Imagine* it should be possible to model anything from a water buffalo to a water molecule.

Any individual point or set of points can be selected with a click, a rectangular drag or a freehand lasso. Similarly any object or set of

objects can be selected – via their axis point. Once they are all selected they can be Grouped so that several objects act as one. All of the normal transformations can then be applied: move, scale, rotate, spin, sweep, extrude, skin etc. Objects can also be conformed to sphere or cylinder shapes. In *Imagine 2*, several of these tools have added parameters, eg Conform to Path spreads the selected object along the path, Replicate makes multiple copies of the object as if it were extruded but without joining the copies.

Points, edges and faces can be manipulated in other ways. Pick Range allows a range of points to be selected with a step. If the step is one, every other point is selected, if it is two every third, three every fourth etc. If a small area needs to be enlarged or distorted in detail, there are often too few points to make smooth transformations. Fracture will double the number of faces in any selected area, increasing the 'resolution' of the object at that point.

Grouped objects can be un-grouped, but if you want several objects to be permanently linked they can be Joined. If a number of points or sides coincide after joining, the Merge command removes surplus points saving memory and making a smoother join. If you need to break the object up again, Join is irreversible but Slice and Split will divide the

IMAGINE 2 is available from **Computech** 0702 206165

Until the end of June, **Amiga Format** readers can get a **40 per cent discount (£164.95)**

THE IMAGINE USER GROUP

If you want to know anything about *Imagine* the people to contact are the Imagine User Group at 16 The Green, Newton, Cambridge CB2 5PL. Tel 0223-872591. Membership is £20 per year. For that you get a disk of objects, images and a regular newsletter.

A NEW IMAGE



Just to prove that Impulse's legendary render-engine is still the best there is. The basic cow was given most of those luscious curves using the magnet tool.

The world fragment was created as one piece in the Forms editor and then given a little roughness in Detail. The junction between green and brown retains its sharp profile because those edges were made sharp in the Detail editor. This tells the Phong shading not to apply to the selected edges. You can also apply Phong to a few edges of a largely faceted object using Make Soft. The Star field is applied as a Global setting in the Action editor. It would be nice if the distribution of stars could be made much less regular - another global parameter perhaps? The deck of the ship was made into a light source to lighten that area evenly, without casting shadows.

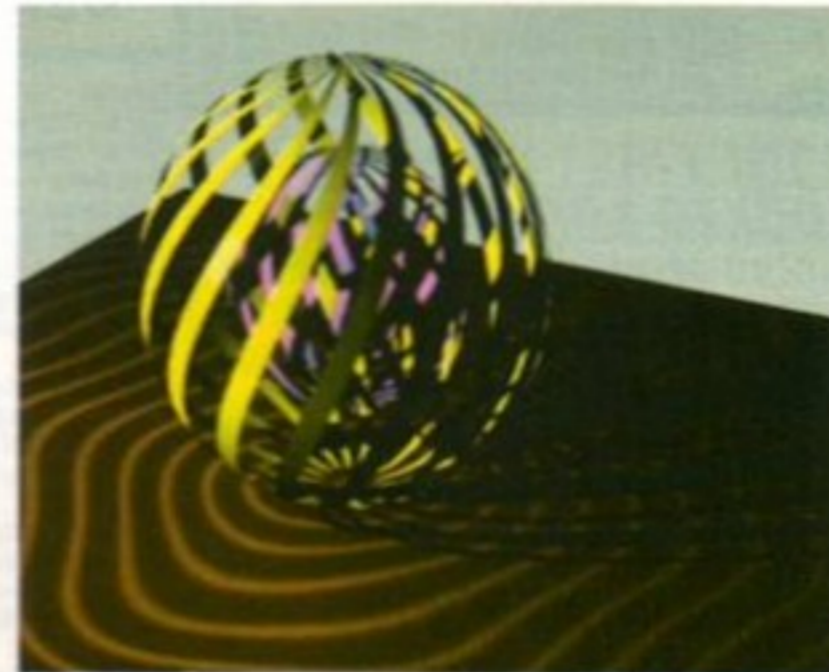

Pick Range allows a range of points to be selected with a step. A step of two was used to delete points on the spheres shown here. The procedure used was: make a ball with 48 circle sections and 24 vertical

sections, select Point Edit Mode, then Pick Range and make the third number - the step - equal three, then delete every selected point.



One of the really powerful aspects of Imagine is the Magnet tool. It was used here to pull Beethoven's face into a bizarre, but convincing distortion. By morphing this change as an animation it would be easy to produce Terminator 2-type effects. The marble texture is produced with three texture maps using the Wood texture with different parameters.

The Detail editor is shown here just as an example of the new look that is in the form of Imagine 2. Notice the button strip at the bottom of the screen. All of the buttons to the right are user-defined.

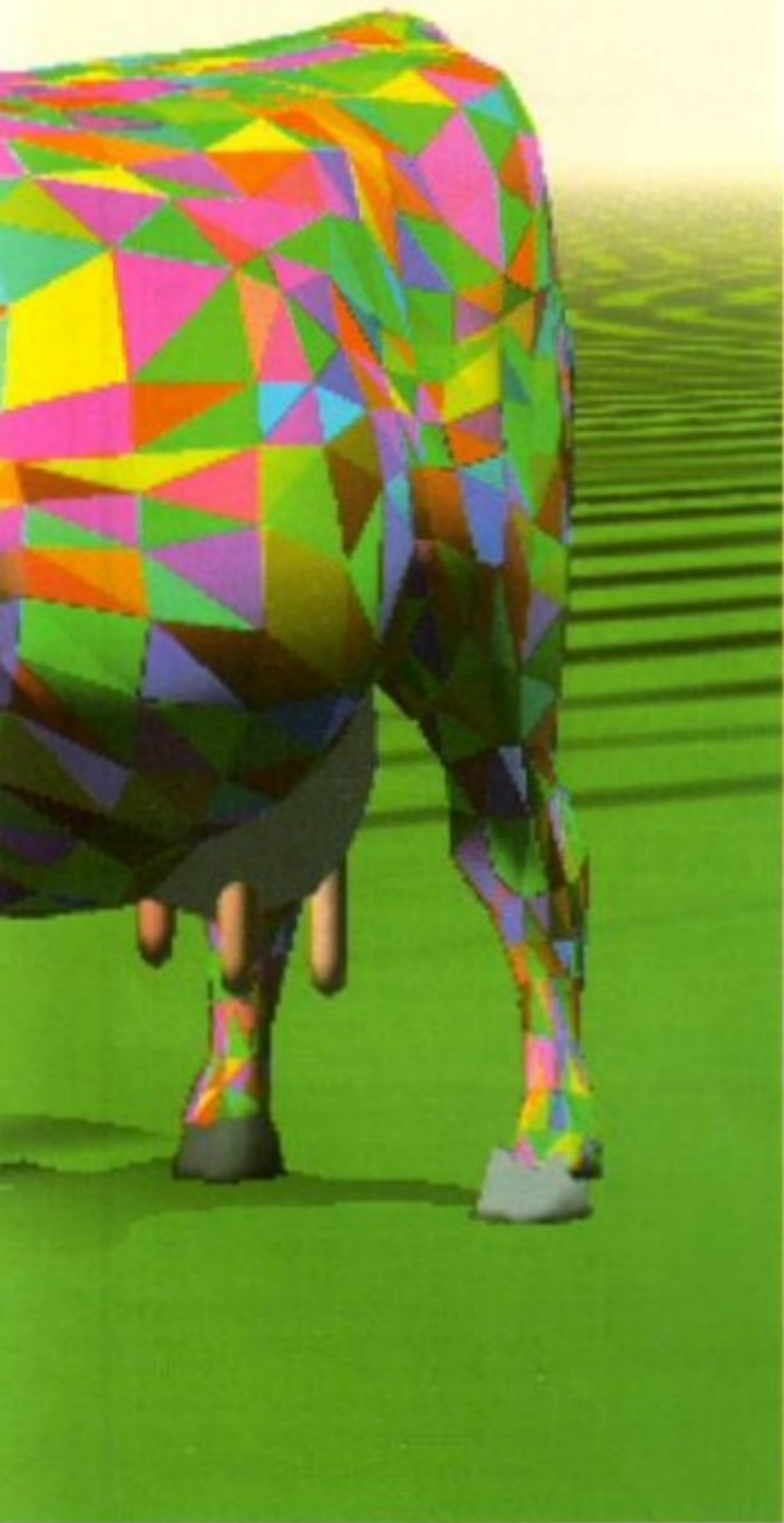
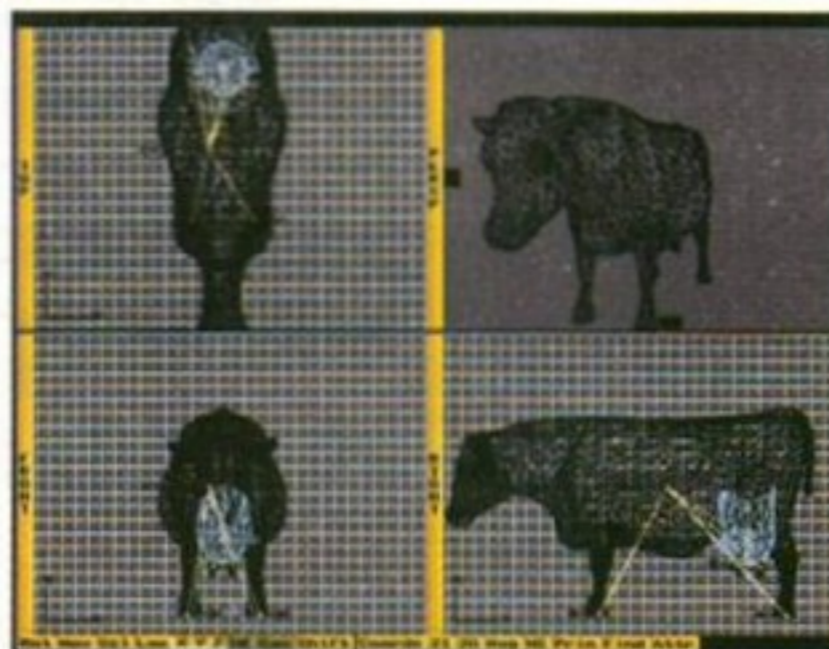

object in various ways. Slice performs a careful Boolean operation, creating new points, sides and faces along the junction of the break; Split is more destructive, it splits selected points and faces away from the object.

In fact, such breaks are not always necessary because selected points in an object can now be defined as a sub-object that can have its own Attributes, though the whole object is still limited to four textures and four wraps in total. Object Attributes remain unchanged apart from two features - default parameters and fog - but these improve ease of use and the quality of rendering. Default parameters for all Textures help the novice and relieve some of the fatigue that experts are faced with when using a lot of different textures.

Saving attributes still leaves out all of the Texture and Wrap information so transferring one set of attributes to lots of objects remains a chore. Come on Impulse, many other software writers have managed to produce an easy-to-use set of complete materials, (Pixar's *RenderMan* for instance). There is one way to overcome this; if you design a really good material, marble for instance, save the object as usual, then select and delete all of the points, NOT the whole object. You will be left with an axis with the attributes attached. Save this to a separate Materials drawer. To apply it

to another object; load the object, load the material axis and position it close to the objects axis, multi-select first the material then the object and simply join them. The object will now have ALL of the attributes of the material. The problem with this method is the size, orientation and position of the textures and wraps may not be right for the new object plus you will have to correct them by hand. In most cases though, with similar sized objects all will be well.

Also in Attributes, Fog Length defines the distance at which an object is half obscured by fog. Scenes can now be given far more atmosphere, getting away from the clean, crystal-clear look that characterises Amiga computer graphics. At the moment there are a few problems when rendering objects in fog but these should soon be overcome.

Apart from the global system changes like the 3D buttons, the button strip, access to the Preferences editor, plus Quickdraw and Quickrender in most editors, very little has changed in the Cycle, Stage or Project editors. Cycle objects can now be set up in the Detail editor and animations can include acceleration (ease-in and -out). There are several new animation effects - Fireworks, Flash and Boing - and two new textures - Waves and Pastella.

The three important aspects of a 3D modelling system are the feel of the interface over a long session, the flexibility of the modeller and the quality of the rendering? Impulse have always had rendering well sewn up, right from the *Silver* days, so apart from a few problems with fog, *Imagine 2* is unchanged in that area; which leaves the interface and the modelling. It is here that most of the new features appear.

The interface will never compete with *Caligari* until it has an editable perspective view, though the button strip is useful. But *Imagine* now looks good and is quick to operate. The real modelling power of *Imagine* is in its object editors - Forms and Detail. These now make *Caligari* look ridiculous and *Real 3D* rather weak in comparison. At the moment it feels as though you could make anything in *Imagine*. You are only limited by your imagination. *Imagine 2* has re-established itself as the Amiga's number one 3D system. 

Imagine 2

SPEED

●●●●

Very fast redraw - *Imagine 2* offers the fastest true ray-tracing available.

DOCUMENTATION

●●●

A proper book this time. Good for beginners but too wordy - poor reference and index.

ACCESSIBILITY

●●●

Rather dense to get into with so many editors but well worth the effort.

FEATURES

●●●●●

Absolutely chock full with virtually everything you might need.

VALUE

●●●●

Very good considering the features - especially the current 40 per cent deal.



93%

POST HASTE

ALL PRICES INCLUDE VAT & DELIVERY TO YOUR DOOR

Select any 3 titles valued £7.99 or less and you pay only £20

SOFTWARE
Some of the following games titles are limited offers at the time of going to press. Order early to avoid disappointment. We stock all the latest and currently available titles which we offer at **30% OFF** Recommended Retail Prices

GAMES

1st Division Manager	6.99
Afterburner	6.99
Altered Beast	6.99
Anarchy	6.99
Armalyte	7.99
Armour Geddon (Psygnosis)	9.99
Awesome (Psygnosis)	9.99
Batman the Movie	6.99
Battle Squadron	7.99
Betrayal	9.99
Beverley Hills Cop	6.99
Blitzkrieg (1 Mb)	12.99
Blood Money	7.99
Bubble Bobble	6.99
Budokan	8.99
Carrier Command	7.99
Chase HQ	6.99
Chuckie Egg	7.99
Chuckie Egg II	7.99
Colossus Chess X	6.99
Combo Racer	6.99
Conqueror	6.99
Daily Double Horse Racing	6.99
Deluxe Strip Poker	6.99
Double Dragon	7.99
Double Dragon II	7.99
Dragon Ninja	6.99
Dragons of Flame	7.99
Enchanter	7.99
Eswat	7.99
F16 Combat Pilot	7.99
FA-18 Interceptor	8.99
Shadow of the Beast	7.99
Fantasy World Dizzy	6.99
Fast Food Dizzy	5.99
Fernandez Must Die	4.99
Fire & Brimstone	7.99
Footballer of the Year II	6.99
Full Contact	7.99
Gauntlet II	6.99
Ghostbusters II	6.99
Ghouls 'n' Ghosts	6.99
Golden Axe	7.99
Gremlins 2	7.99
Head Over Heels	6.99
High Energy (Compilation)	12.99
Hitchhiker's Guide to the Galaxy	7.99
Hong Kong Phooey	6.99
Immortal	8.99
Impossible	6.99
Indy Jones - Last Crusade Action	6.99
International Karate - Italia 90	6.99
James Pond	6.99
Jockey Wilson Darts	6.99
Jet (Sublogic)	8.99
Jet Set Willy II	7.99
Keef the Thief	7.99
Kick Off II	9.99
Kick Off II Europe	6.99
Kick Off II Giants of Europe	6.99
Killing Game Show (Psygnosis)	9.99
Klax	6.99
Last Ninja II	6.99

WINNING FIVE
Iron Lord,
Night Hunter,
Sir Fred,
Twin o World
Puffy's Saga
Value at only £9.99 the Lot!

Leather Goddesses of Phobos	7.99
Line of Fire	7.99
Lombard RAC Rally	6.99
Lotus Esprit Turbo Challenge	7.99
Magic Fly	8.99
Manchester United	7.99
Manic Miner	7.99
Menace	7.99
Midnight Resistance	6.99
Moonwalker	6.99
New Zealand Story	6.99
Nightbreed (Action Game)	4.99
Ninja Rabbit	5.99
Ninja Warriors	7.99
Nitro	7.99
North & South	6.99

HIGH ENERGY
NORTH & SOUTH
HOSTAGES
TEENAGE QUEEN
TINTIN ON THE MOON
FIRE & FORGET
SUPERB ACTION FOR
ONLY £12.99

Obitrus (Psygnosis)	9.99
Operation Thunderbolt	7.99
Pacland	6.99
Pacmania	7.99
Paperboy	6.99
Pick 'n' Pile	7.99
Planetfall	7.99
Populous	8.99
Populous Promised Lands	4.99
Power Drift	6.99
Puzznic	7.99
Quest of Agravain	6.99
R-Type	6.99
Rainbow Islands	6.99
Rambo III	6.99
Rick Dangerous	6.99
Roadblasters	6.99
Robocop	6.99
Ruff 'n' Ready	6.99
Scooby Doo & Scrappy Doo	6.99
Shadow of the Beast	7.99
Shadow Warriors	6.99
Shinobi	6.99
Shootemup Construction Kit	9.99
Silkworm	6.99
Ski or Die	6.99
Speedball 2	9.99
Steve Davis Snooker	6.99
Stunt Car Racer	6.99
Super Grand Prix	5.99
Super League Soccer	6.99
Super Scramble Simulator	6.99
Swiv	7.99
Terrorpods (Psygnosis)	4.99
Thunderblade	6.99
Tie Break (Tennis)	7.99
Top Cat	6.99
Impossible	6.99
Indy Jones - Last Crusade Action	6.99
International Karate - Italia 90	6.99
Turrican	6.99
Turrican II	7.99
Ultimate Ride	7.99
Universal Military Simulator 1	9.99
Untouchables	6.99
Venus the Flytrap	6.99
Viz	7.99
WarZone	7.99
White Death (1 Mb)	12.99
Wings (1mb)	9.99
Winning Five (Compilation)	6.99
Winning Tactics	6.99
Wishbringer	7.99
Wolfpack	9.99
World Championship Soccer	7.99
World Class Leaderboard	6.99
World Cricket	6.99
Xenon	6.99
Yogi's Great Escape	6.99
Yolanda	7.99
Z-Out	6.99
Zork, Zork II or Zork III	7.99

EDUCATIONAL

Answerback Junior	14.49
Answerback Senior	13.99
Arithmetic (Answerback facts)	7.49
Ass Football (Answerback facts)	7.49
Spelling (Answerback facts)	7.49
Better Maths (12-16)	16.49
Better Spelling (over 8)	16.49
Cave Maze	10.99
Count and Add	16.99
Data World	13.99
Distant Suns (Astronomy)	42.99
Deep sky Objects	14.99
Skymap Expansion	14.99
First letters (Under 5)	6.99
Fun School 2 (2-8, 6-8, or 8+)	13.99
Fun School 3 (2-5, 5-7, or 7+)	13.99
Fun School 4 (2-5, 5-7, or 7+)	13.99
Game Set and Match	16.99
Kid's Type	13.99
Lets Spell at Home	13.99
Lets Spell at the Shops	13.99
Lets Spell Out and About	13.99
Magic Maths (4-8)	16.49
Magic Storybook (1 Mb)	19.99
Match Pairs	7.99
Maths Adventure	16.99
Maths Dragon	10.99
Maths Mania (over 8)	16.49
Mavis Beacon Teaches Typing	19.99

BE AMONG THE FIRST TO PLAY !!!
PRE-BOOKED SOFTWARE
We accept advanced orders for all forthcoming software titles and your order will be despatched on the day of release. Your credit card will be debited also on the same day as despatch !!!

TOP TITLES SPECIALS
Lotus Turbo Esprit 2, Robocop 3, Robocop, Agony, Lemmings, Black Crypt, Space Crusade, Harlequin, Dizzy's Excellent Adventures, Parasol Stars, Epic, Project X, Monkey Island, John Madden's Football... **£18.99 EACH**
Jimmy White's Snooker, Realms, Thunderhawk, Knightmare, Populous II, Battle Isle, Monkey Island II, Ultima IV, Castles... **£18.99 EACH**
Knights of the Sky, Flight of the Intruder, Silent Service II, Microprose Grand Prix, Willy Beamish, Heimdall, A10 Tank Killer Enhanced, Special Forces, A320 Airbus, Microprose Golf, Leisure Suit Larry 5... **£22.99 EACH**

Compendium SIX
Kids Type
Weather Watcher
What is it Where is it?
Calendar Quiz
Words & Numbers
Game, Set & Match
Only £29.99

Mega Maths	17.99
Mickys Crossword Puzzle	17.49
Micro English	17.99
Micro French	17.99
Micro Maths	17.99
Mix & Match	16.99
Paint Me a Story	16.49
Pepe's Garden	16.99
Picture Book	13.99
Reasoning with Trolls	10.99
Sooty's Fun With Numbers	13.99
Spellbook	7.99
Target Maths	13.99
Things to do with Numbers	13.99
Things to do with Words	13.99
Thomas the Tank Engine	13.99
Three Bears	16.49
World Atlas	44.99

SERIOUS

VIDEO & MULTIMEDIA

Photon Video (Cel Animator)	7.99
Deluxe Video III	59.99
Aegis Animagic	59.99
Broadcast Titrer 2	174.99
Broadcast Titrer Font Pack	99.99
Broadcast Titrer Font Maker	99.99
AmigaVision	89.99
Showmaker	239.99
Cando	119.99
Cando ProPak	27.99
Hyperbook	49.99
Scala	174.99
Scala 500	74.99
Director II	79.99
TV Text Professional	89.99
TV Show 2	49.99
VideoTitrer 1.5 3D	69.99

WORDPROCESSING

Scribble Platinum	29.99
Interword	39.99
Final Copy	59.99
Penpal	59.99
Excellence 2	59.99
Protext 4.2	69.99
Protext 5.5	99.99
ProWrite 3.1	99.99
Word Perfect 4.1	159.99
Word Perfect Library	79.99

Wordworth 89.99

SPREADSHEET

ProCalc	149.99
Advantage	79.99
DG Calc	28.99

DATABASES

Infofile	34.99
Superbase Personal 2	69.99
Superbase Professional 4	199.99

INTEGRATED (WP/SP/DB)

The Works Platinum	59.99
Gold Disk Office	109.99
DTP	149.99
PageStream	52.99
Pagesetter 2.0	99.99
Pro Page 1.3	99.99
Pro Page 2.1	99.99
Pro Draw 2	99.99
Outline fonts	99.99
Gold Disk Fonts 1-4	34.99
Structured Clip art	39.99
Eclips	79.99
Proclips	17.99
Pro Vector	159.99
Designworks	79.99
Deluxe Print II	34.99

CAD

X-CAD 3D	299.99
X-CAD Professional	149.99
Aegis Draw 2000	99.99

ACCOUNTS

Home Accounts 2	39.99
Cashbook/Final Accounts	44.99

PERSONAL TAX PLANNER

Personal Finance Manager	29.99
Personal Finance Manager	21.99
Small Business Accnts Cash	59.99
Small Business Accnts Xtra	79.99

MUSIC X Jnr
Excellent MIDI Value at an incredible Mini price.
Only £19.99

Butcher 27.99

The Art Department 49.99

The Art Department Pro 2.00 134.99

Kara Anim Fonts 1, 2 or 3 29.99

Kara Fonts Headlines 1 or 2 49.99

Kara Fonts Sub Headlines 44.99

3D MODELLING & RENDERING

3D Construction Kit	32.99
4D-Professional	199.99
Sculpt 3DXL	84.99
Sculpt Animate 4D	199.99
Vista Professional	69.99
Scenery Generator	32.99
Scenery Animator	59.99
Imagine	149.99
3D Professional	349.99
Real 3D Beginners 1.4	119.99
Real 3D Professional/Turbo 1.4	299.99

PROGRAMMING

AMOS	32.99
AMOS Compiler	20.49
AMOS 3D	23.49
Dewpac 3	49.99
Hisoft Basic	57.99
Hisoft Basic Extend	14.49
Hisoft Pascal	74.99

MUSIC

Stereo Master	29.99
Deluxe Music Const. Set	49.99
Music X Jnr	19.99
Quartet	35.99
Mastersound sound sampler	29.99
Audio Engineer Sound Sampler	179.99
Bars & Pipes Professional	174.99
Bars & Pipes Int. Sound Kit	49.99
Bars & Pipes Music Box A	49.99
Bars & Pipes Music Box B	74.99

SuperJam 74.99

MISCELLANEOUS

AREXX	32.99
BAD Disk Optimiser	34.99
Cross Dos 4	29.99
Dos 2 Dos	39.99
Disk Master	39.99
Disk Master II	44.99
Faccll	24.99
GB Route Plus (New Version)	54.99
Icon Paint	8.99
Quarterback HV Disk Backup	49.99
Quarterback Tools	59.99

HARDWARE

Amiga 500 Basic (1.3)	289
A500 Plus Cartoon Classics	359
A500 Class of 90's Pack	469
A1500 Including Monitor	749
A1500 No Monitor	549
A2000 40Mb HDDisk	899
A3000	POA
CDTV	469
10% OFF all CDTV software	
A590 20Mb Hard Drive	279
A590 20Mb H/Drive-2Mb RAM	339
GVP A500 52Mb-8MbRAM(0k)	359
GVP A500 105Mb-8MbRAM(0k)	549
GVP SCSI Controller-8Mb(0k)	139
GVP SCSI 52Mb-8MbRAM(0k)	269
GVP SCSI 105Mb-8MbRAM(0k)	459
GVP SCSI 200Mb-8MbRAM(0k)	829
45Mb to 520Mb Bare hard disks	POA
44Mb Syquest Removable HDDisk	389
Cumana 3.5" External Drive	55
Zydec 3.5" External Drive	51
RF 5.25" External Drive	99
A500 3.5" Internal Drive	49
CBM 3.5" Internal Floppy Drive	119
A500 512k Ram Upgrade(no clock)	25
A500 512k Ram Expansion-clock	29
1.5 Mb Ram Expansion	79
Supra 500RX 8Mb RAM (2Mb Pop)	149
Supra 500RX 8Mb RAM (4Mb Pop)	219
Supra 500RX 8Mb RAM (8Mb Pop)	339
A2000/1500 8Mb Ramcard	189
256kx4 RAM chips per Mb	35
1Mbx1 DRAM chips per Mb	35
A1-Once PC 286 Emulator	179
Colour Solution(Vidi-RGBsplit)	159
Sharp JX100 A6 Col. Scanner	549
Zydec Hand Scanner	99
Genitizer Graphics Tablet	129
Zydec Microswitched Mouse	17
Naksha Mouse-Operation Stealth	22.99
Mouse Mat	4
50 Blank Disks	25

MONITORS

Philips 8833-II Visto (inc Lead)	219
Philips 8833-II (inc Lead)	239
Commodore 1084 s	239
Commodore 1050 Multisync	499

PRINTERS

(inc. leads-Amiga Printer Drivers)

Star LC200 Colour	219
Star FR-10 Colour	279
Star LC24-200 Mono	259
Star LC24-200 Colour	299
Starscript Postscript Laser	1099
Citizen Swift 9 Colour	199
Citizen Swift 24e Colour	299
Citizen 224 Colour	259
Canon Bubblejet Portable	249
HP Paintjet Colour Inkjet	825
Panasonic 4420 Laser	849
Panasonic 4420 1Mb Upgrade	199

AMIGA 500 PLUS CARTOON CLASSICS PACK
Latest specification 1Mb RAM, Workbench 2 with enhanced chipset (Up to 2 Mb Chip RAM)
Plus usual Cartoon Classics Software Pack!!!
Only £359
One Meg Upgrade for A500 Plus Enables 2Mb CHIP RAM....£44.99

You name it... We do it... Just phone and we'll quote... We are faster and cheaper!

PRICES QUOTED ARE SUBJECT TO AVAILABILITY.. SOME OFFERS ARE LIMITED SO ORDER EARLY TO AVOID DISAPPOINTMENT

Cheques/PO Orders to **POST HASTE**, 11a Burgate Lane, Canterbury, Kent. CT1 2HH

TELEPHONE HOTLINE 0227-764204 9.30am to 7.00pm

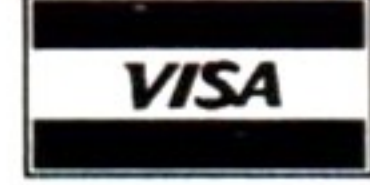

(Answerphone outside normal hours)
VISA, MASTERCARD and EUROCARD orders welcome
Visa, Mastercard, Eurocard and PO Orders are despatched same day!
Please allow up to 4 working days for cheques to clear. Overseas orders add £2.00 postage.
MAIL & TELEPHONE ORDERS ONLY.... NO PERSONAL CALLERS PLEASE!



POWER COMPUTING

Power Scanner v2.0



Features

- 100-400 DPI scanning resolutions
- 64 Greyscales
- Thru'port for printer

Software

- Full screen image editor
- Interlace mode on/off
- Edit true greyscale & colour images
- Fully multi-tasking

Editing

- Cut rectangle, cut lasso, crop, flip, rotate, scale, draw, lines, circles, boxes ellipses, freehand, zoom mode

Scanning

- Unique 'True feel' real time scan mode - Know instantly if you are scanning the image too quickly
- Automatic selection of 100-400 DPI
- Produce true greyscale images

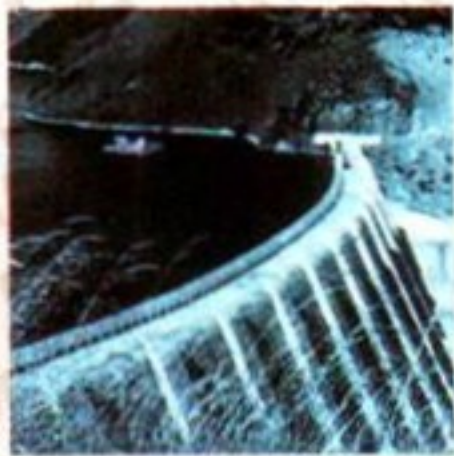

Actual Amiga Screen Shots

Amiga can only display 16 greyscales

£99 inc. VAT **£239** inc. VAT
GREYSCALE COLOUR

PC880B Power Drive



£69.95

Viruses, diskswapping, clicking drives, disks which won't back up. Is there no end to the whingeing of the Amiga user?

At Power, we want to tell you just where you can stick your disks and worries. In fact we will show you. The slot in this picture belongs to our PC880B, the first intelligent disk drive. Insert a disk.

Now you can back up at lightning speeds using the inbuilt Blitz Amiga hardware*, with free software, (even if the disk is Atari or PC) and if your computer has a virus the PC880B will stop it being written to the bootblock of any of your drives, though you can still save files as normal.

When you do not want these features, switch them off and the PC880B will sit quietly, without clicking, pretending to be simply an extra drive.

The PC880B, the only drive to introduce Blitz Amiga, the Power anti-click device and to combat viruses, is only available direct from Power, priced at just **£69.95**

We have noticed how pricey unintelligent drives are. Perhaps, it's your turn to tell people where to stick it.

*Due to the precision nature of the Blitz copier high density disks may be required with some internal drives.

Dual Drive



£125

Our latest dual drive uses the slimline, ultra low power NEC drive mechanism. This drive takes less than half the power of a normal floppy drive. The new dual drive includes all the features you would expect from a Power Computing Drive.

The NEC drive mechanism is able to access high density 1.44MB disks. While this may not be of use to you at the moment (the Amiga can only access 880K), watch this space for our new 'high density' Interface, on the market soon!

Whisper quiet operation

Blitz Copier built-in (switchable)

Virus blocker built-in (switchable)

Anti-click

PSU included

New Products

Released or available soon

- 8MB board with thru'port
- 1.44MB interface
- 1.44MB disk drive
- Scanner software upgrade
- PC880B with X-Copy
- Power Scanner v2.0

Name

Address

Postcode

Telephone No.

System owned

Description

Credit card No.

Expiry date

I enclose a cheque/postal order for £

Signature

Make cheques payable to **Power Computing Ltd**

Power Computing Ltd
Unit 8 Railton Road
Woburn Road Industrial Estate
Kempston Bedford MK42 7PN
Ring your credit card order through on **0234 843388** or fax your order on **0234 840234**

All prices include VAT, delivery and are subject to change. Specifications are subject to change without notice. Next day delivery £4.50 (U.K. mainland only), all trademarks acknowledged.

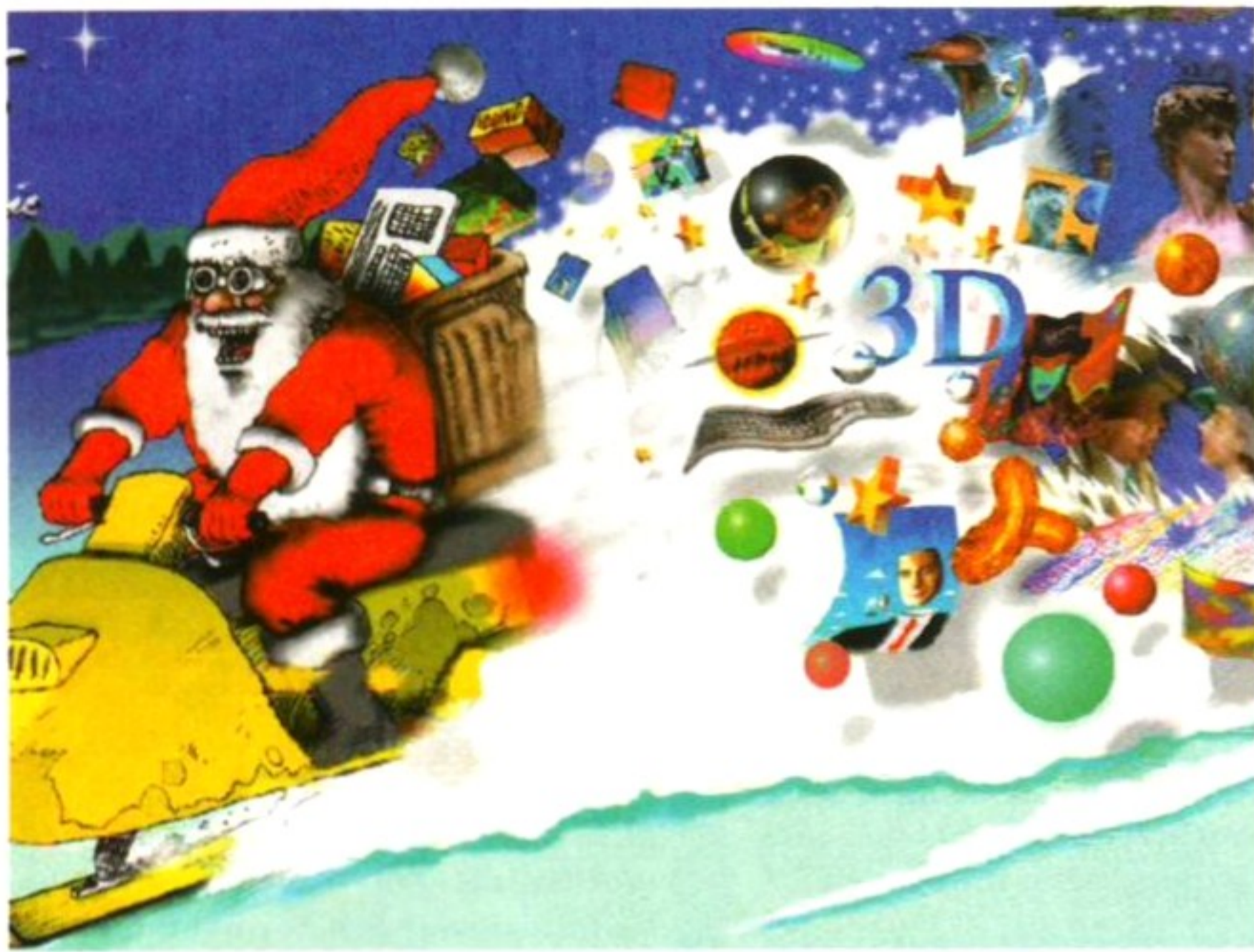

OK, it's not a very seasonal picture seeing as the majority of the population are currently getting out their bucket and spade and jetting off to Greek isles, but this work of art is included with TVPaint and illustrates well the graphics effects you too can achieve on your Amiga.

TV Paint 1.6

True Colour Art Package ■ £940 ■ TecSoft

TVPAINT WAS DEVELOPED from scratch by the French company TecSoft in just three months last year. Development has slowed down, but it's still improving version-by-version. In our first review (Issue 27) it was a joy to use but there was no gradient fill, ellipse or brush distortion. Version 1.6 has taken care of these and added some excellent new tools.

Gradient Fill has now been implemented, though more types of gradient would be useful. Linear and circular types are provided but not the logarithmic gradient necessary for rounded surfaces. Up to four cycles can be set in the Cycle requester, provided the required gradients of colour are produced in the palette. A more elegant solution like the colour 'beads' used in *Deluxe Paint IV* could surely have been devised. Once the cycle ranges are set up they can be used for fills when the respective buttons are selected. All filled tools can use the gradients, and the direction of the gradient is set by a line from the centre of the object indicating the pseudo-light direction.

Brush distortion has been provided but only as a 'brush fill', controlled from the Cycle requester. Any current custom brush can be wrapped horizontally, vertically or both. Only one brush can remain in memory at once. Drawing a perspective box allows a sort of perspective, but real distortion, bending, skewing and true perspective are sorely needed. The ellipse tool now works normally, though it is not possible to rotate the shape other than as a custom brush. Other new features are several new modifiers and modes: Light, Shift, Dither and Grain; a complete control panel for the Airbrush; Big Screen; new load and save options including JPEG compression and support for AREXX and an 8-bit Alpha channel.

Light allows areas to be lightened



smoothly and highlights added. Shift is a powerful way to shift or flow areas of the screen around smoothly. By using Shift the corner of a mouth can be lifted into a smile, a nose lengthened slightly, all without noticeable distortion. Magic! Dither and Grain are great for adding real-life texture and 'grime'.

The new control panel for the Airbrush adds even more flexibility and unique power to an already beautiful tool. The Airbrush controls resemble the Density's in that they provide a graphical profile of the spray pattern that can be defined by the user. Also both panels have a set of predefined shapes that can be applied to the profile. These give the spray pattern a level of complexity that could never be simulated with a real airbrush.

Big Screen allows a SuperBitmap to be loaded area-by-area for editing. Large 24-bit scans can be de-compacted to temporary files which can be viewed in reduced form. This is then loaded at full size for editing and saving. If the Shift Mode seems like magic then JPEG

This whole drawing is produced by selecting one AREXX script with a single key press. It looks very much like all of the drawing operations were stored as a macro, recording all mouse moves and tool selections as they were made. If this is possible without writing a script file the possibilities are quite endless.

Of all the pages, in all the magazines, **Brian Larkman** chooses this one to illustrate the update of the paint program that has a certain je ne sais quoi...

compression seems like a miracle. After a year of keeping 24-bit images small, it seems amazing to fit 10 or more large pictures on a one meg disk with no loss of detail. TVPaint now offers JPEG and TVDC compression as well as DEEP, Rendition (*Caligari*), in addition to the standard Amiga IFF file formats.

Although it only displays 24 bits of colour, the ACS Harlequin board is actually a 32-bit buffer. The extra 8-bits are used as an Alpha channel. This works like this; if you want a custom brush to blend into a background you either anti-alias the edge or better still you make the pixels at the edge partially transparent to the background. TVPaint can do this by using Rub Thru or Transparent mode, bringing the image from the spare screen using a soft-edged density setting. If the custom brush or foreground image is placed over a genlocked image coming from a live video source, the jaggies at the edge cannot normally be anti-aliased; the video replaces just the single background colour. With an Alpha channel an 8-bit mask can be created to tell the genlock how transparent to make the foreground image. In theory the Alpha channel can also be used to make a semi-transparent stencil for the working screen, but with very poor instructions, it is impossible to fathom out how!

The final new feature is AREXX support. Up to 10 AREXX command scripts can be resident at once – launched via a menu or a key press – and any other command script can be loaded from memory or typed in. Presently all of the scripts included perform predetermined routines without any user input. However it is possible to write a script to set up a particular set of parameters and produce your own specialised tool or image processing effect.

The new attributes have managed to make TVPaint immensely powerful and the slickest of all Amiga paint programs.

TVPaint 1.6

SPEED ●●●●●
No faster than version 1.0 – but still as fast as *Deluxe Paint III* – with 16 million colours!

DOCUMENTATION ●●
Still being added to – but a proper manual is promised. About time too for all that cash.

ACCESSIBILITY ●●●●●
Still beautiful though a few of the functions are in curious places.

FEATURES ●●●●●
Still getting better but some functions need more user control.

VALUE ●●
It is getting cheaper but it is still a little bit too expensive.

89%

TVPaint is available from Amiga Centre Scotland 0896 87583

THE NEW WINDOW IN THE WORLD OF COMPUTER SHOPPING!

With over 150 stores nationwide and still growing, **Calculus** is the largest Independent Computer Multiple in the UK. Each store is independently owned guaranteeing you a high level of service and support.

Calculus offers you the advantage of discussing your purchase decision with a real specialist who can advise you before you buy and, more importantly, will be there to assist you later if you need support or guidance.

CALCULUS STORES THROUGHOUT THE UK.

SCOTLAND

● ABERDEEN ● AYR ● BO'NESS ● DUNDEE ● DUNFERMLINE ● EDINBURGH ● FORRES ● GLASGOW

ENGLAND

● ACCRINGTON ● ALTON ● AYLESBURY ● BARNOLDSWICK ● BARNSELY ● BECKENHAM ● BEXHILL ON SEA ● BIRKENHEAD ● BIRMINGHAM ● BLACKPOOL ● BOGNOR REGIS ● BOLTON ● BRADFORD ● BRIERLEY HILL ● BRIGHTLINGSEA ● BRIGHTON ● BRISTOL ● BROMLEY ● BURY ST EDMUNDS ● CARLISLE ● CHALFONT ST PETER ● CHESHUNT ● CHESTER ● CHESTERFIELD ● CLECKHEATON ● CLEVELAND ● CLEVELEYS ● COLCHESTER ● COVENTRY ● DARLINGTON ● DERBY ● DEWSBURY ● DONCASTER ● DUDLEY ● EASTBOURNE ● EAST GRINSTEAD ● EDGWARE ● ELLESMERE PORT ● ENFIELD ● EXMOUTH ● FAREHAM ● FARNBOROUGH ● FELIXSTOWE ● FORMBY ● GATESHEAD ● GLOUCESTER ● GOSPORT ● GRANTHAM ● GUILDFORD ● HALIFAX ● HARROGATE ● HARROW ● HAYES ● HUCKNALL ● HUDDERSFIELD ● HULL ● IPSWICH ● KINGS LYNN ● LANCASTER ● LEAMINGTON SPA ● LEEDS ● LEICESTER ● LIVERPOOL ● LYTHAM ST ANNES ● MACCLESFIELD ● MAGHULL ● MANCHESTER ● MANSFIELD ● MIDDLESBROUGH ● MORDEN ● NEWCASTLE UPON TYNE ● NORTH FINCHLEY ● NORTHWICH ● NOTTINGHAM ● PADDINGTON ● PENRITH ● PETERBOROUGH ● PRESTON ● PLYMOUTH ● RAMSGATE ● READING ● REIGATE ● ROSSENDALE ● ROTHERHAM ● SCUNTHORPE ● SHEFFIELD ● SOUTHAMPTON ● SOUTHGATE ● SOUTHPORT ● STAMFORD ● STOCKTON ● STROUD ● SUNDERLAND ● SWINDON ● THETFORD ● UXBRIDGE ● WALSALL ● WAKEFIELD ● WARLEY ● WEMBLEY ● WEST BROMWICH ● WEYBRIDGE ● WHITBY ● WOLVERHAMPTON ● WORCESTER ● YORK

WALES

● CARDIFF ● CARMARTHEN ● HAVERFORDWEST ● LLANDARCY ● RHYL ● SWANSEA

N. IRELAND

● BELFAST ● ENNISKILLEN

FOR YOUR LOCAL CALCULUS STORE

CALL 0543 251275

Phone lines open 9.30am to 5.00pm (Mon. to Fri.)
and 9.30am to 4.30pm (Saturdays)



CALCULUS

C O M P U T E R S T O R E S

A
GREAT
DEAL
& MORE

FROM
YOUR
LOCAL
STORE

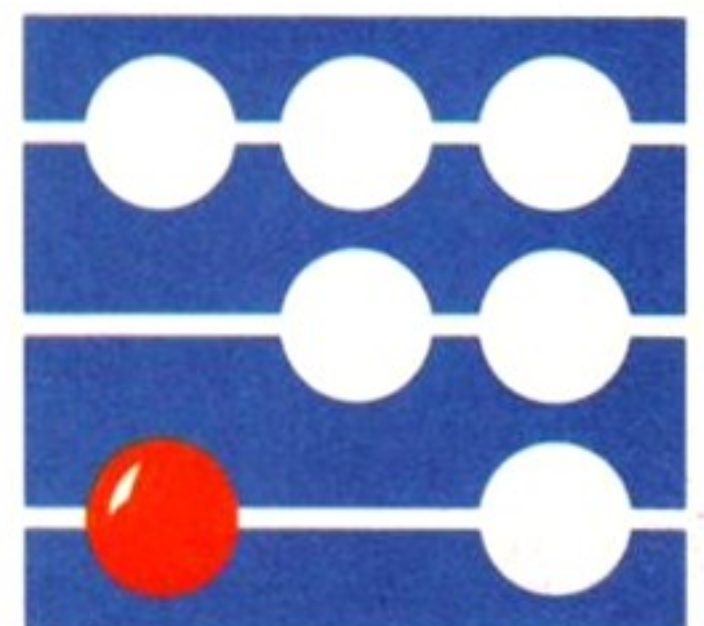
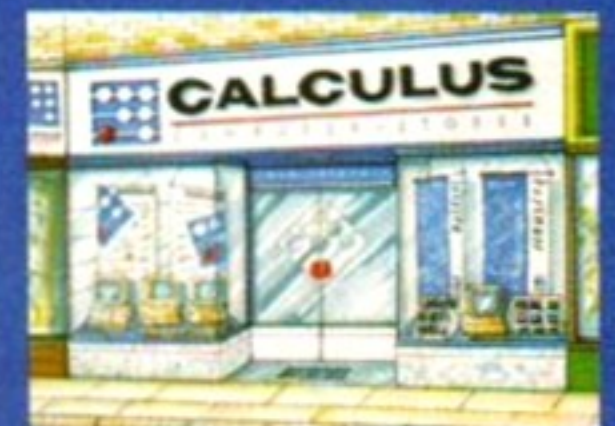

AMIGA 500 PLUS CARTOON CLASSICS



Complete with the following:-

- Amiga 500+ computer with 1Mb RAM
 - A520 TV Modulator
 - 1352 2 Button Mouse
 - Workbench 2 Disks and Manuals
- LEMMINGS** Are you as smart as Lemmings are stupid? Match your intelligence against their lack of it as you play the most original game of 1991.
- THE SIMPSONS - BART vs THE SPACE MUTANTS** Hello fellow humans! Bartholomew J Simpson here,

with a very important secret: SPACE MUTANTS ARE INVADING SPRINGFIELD.

CAPTAIN PLANET AND THE PLANETEERS Captain Planet and the Planeteers has turned saving the Earth's environment into the ultimate adventure.

DPaint III The program that sets the standard for computer painting now with animation.



RRP - £399.99

CALCULUS PRICE

£349.99

THE NEW A570 CD DRIVE



ARRIVING SOON

The new A570 CD drive is at last on its way and will be in Calculus stores in May 1992. Pricing has now been agreed allowing you to upgrade your Amiga A500 for only £299.99.

Initial demand will outstrip supply, please call now for the number of your local store to reserve your A570. With the new A570 CD drive attached to your A500 Amiga* you will have essentially the same capabilities as Commodore's CDTV player. Like the CDTV your new system will allow you to play any CDTV title as well as CD+G, CD+Midi and standard audio CD's.

The A570 installs easily, no software installation is required, you can continue to use your Amiga keyboard, mouse and monitor for inputs and displays.

*Minimum configuration standard for A570 compatibility 2.04

AMIGA CDTV UPGRADE PACK

The CDTV Amiga Upgrade Pack allows existing CDTV owners to tap into the massive base of Amiga 3.5" games software.

Upgrade Pack contains:-

- CDTV Amiga keyboard
- 3.5 CDTV Amiga external black drive

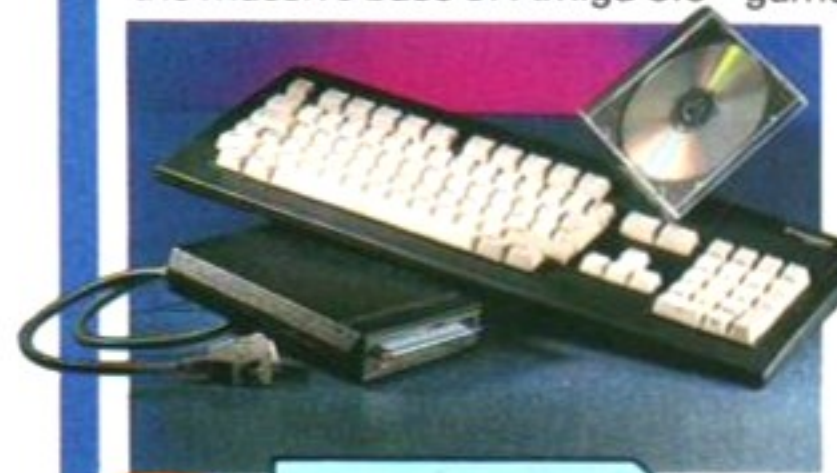

FRED FISH MEGADISC
530 TITLES ON THIS ONE CDTV DISK WITH THIS PACKAGE!!!

PLUS



WORTH £79.00 R.R.P.



RRP - £208.99

CALCULUS PRICE

£149.99

THE NEW AMIGA 600



The new super compact Amiga 600 represents state-of-the-art in Amiga technology using the powerful Workbench 2 and the new Kickstart 2.05. The 600 features extensive use of surface mount technology (SMT) and a lower component count contributing to a computer with unparalleled reliability and performance.

The Amiga 600 has 1Mb of Chip RAM, expandable to 2Mb with a new 601 RAM Upgrade. An industry standard PC... Smart Card Interface allows the use of Fast RAM Cards and future expansion using open channel technology. The standard IDE interface has been adopted by Commodore for the first time in an Amiga product, offering an internal hard drive option using 2.5" drive technology. Even the external modulator has disappeared in favour of an internal integrated modulator.

The Amiga 600 is available in two versions, a single floppy drive and a 20Mb hard drive, both products come with 12 months free on-site service.

AMIGA 600

AMIGA 600HD

NEW PRODUCT

CALCULUS PRICE

£399.99

£499.99

MESSAGE TO DEALERS

Calculus is the largest computer group in the U.K. with over 150 stores each one owned by an Independent retailer committed to the highest possible standards of service. If you are an independent retailer with an appropriate retail premises capable of supporting our Calculus range of products then perhaps we should be talking.

For further information call Calculus on 0543 414817 and ask for Calculus dealer recruitment.

COMMODORE PC PLAYER

For the serious games player who also needs the latest in PC286 MS DOS processing power, Calculus launch the new Commodore PC Player, a saving of £62.00 and 12 months free on-site maintenance.



COMMODORE PC PLAYER

THE POWER

New slimline 286-16 Mhz
40 Mb I.D.E. fast access hard drive
1 Mb Ram expandable to 5 Mb
3.5 inch 1.44 Mb floppy drive
256K Video Ram (Expandable to 512K).
Latest MS Dos 5 Operating System. 1360 Mouse
14" VGA Colour Monitor

THE PLAYER

Adlib Sound Card and Stereo Speakers
Games: Pit Fighter, Super Space Invaders, Hard Drivin II, Mig 29, Trivial Pursuits, Escape from the Planet of the Robot Monsters, Castle Master, Wing Commander.
Business: Office Manager (Word Processor, Database and Spreadsheet)

RRP - £822.49
**CALCULUS
PRICE**

£759.99 (£646.80
Ex VAT)

SAVE
62

AMIGA 1085s STEREO MONITOR



LIMITED
STOCK

Direct from Commodore's warehouse, Calculus are the first in the U.K. to receive the new Commodore 1085s Stereo Monitor. Compatible with all Amiga products, the new 1085s is not only the latest Commodore monitor but also the best priced. With our buying power, we are able to offer the very latest Commodore monitor at only £219.99 featuring

- Stereo sound
- High Resolution Display
- Ergonomic design
- Full Amiga Connectivity Pack
- Compatible with all Amiga products

SAVE
80

RRP - £299.99
**CALCULUS
PRICE**

£219.99

COMMODORE MPS 1270



Is this the best value Ink Jet Printer on the market? We think so. Whisper quiet yet still achieves an amazing 160 CPS. This limited offer is definitely whilst stocks last.

RRP - £149.99
**CALCULUS
PRICE**

£129.99

SAVE
20

COMMODORE MPS 1230



A high quality 9 pin Dot Matrix Printer with paper & tractor feed, is fully compatible with Epsom FX80 and IBM Industry Standards. High speed 120 CPS draft mode and an NLQ mode of 25 CPS.

RRP - £169.99
**CALCULUS
PRICE**

£139.99

SAVE
30

COME &
SEE MORE
GREAT
DEALS ON
LEADING
BRANDS
AT YOUR
LOCAL
CALCULUS
STORE



FREE!
20 DISK CAPACITY
COMMODORE BRANDED
DISC WALLET
WORTH **£12.95**

WHEN YOU PURCHASE
ANY PRODUCT IN
OUR MAY CALCULUS
ADVERTISEMENT.

(Present this voucher at your local Calculus store. Valid whilst stocks last.)

YOUR LOCAL STORE... PHONE 0543 251275... FOR YOU

THE NEW AMIGA 1500

The Amiga 1500 system offers total compatibility with the Amiga 500, with an unbelievable level of internal expansion options.

All our Amiga 1500's featured, are the latest version, featuring Kickstart 2 ROM and Workbench 2, offering significant enhancements over the previous model.



AMIGA 1500 STARTER PACK



- **AMIGA 1500 'CALCULUS' STARTER PACK** Amiga 1500 Dual Drive, 1Mb RAM Mouse, Manuals and Amiga DOS.
- **THE WORKS - PLATINUM EDITION** A full integrated software package with Word Processor (inc. English Dictionary) Spreadsheet and Database Package.
- **DELUXE PAINT III** Probably the best paint package available, allowing you to display your hidden talents. This award winning software allows you to paint, design or animate.
- **HOME ACCOUNTS** Home accounts with budgeting, forecasting and graphics.
- **ELF** - You will encounter Cornelius the Elf on your travels in the mystical lands of Gooks and Goblins. Weird villainous creatures and devious puzzles test your gameplay techniques and gnostic powers.
- **TOKI** - The arcade sensation that swept the world. Toki has been transformed into a monkey by the evil wizard. He must now try to regain his manhood and rescue his beloved princess Miho. Join Toki on his mythical adventure, full of demons and deadly witchcraft.
- **PUZZNIC** - A puzzle game to top them all. It's fast, furious and devilishly addictive. With 144 levels, the action never stops.

RRP - £699.99

CALCULUS PRICE

£579.99 (£493.60 Ex VAT)

POWERED BY QUANTUM FAST ACCESS HARD DRIVE

AMIGA 1500 HD

PROFESSIONAL PACK

Amiga 1500 Dual Drive with 52Mb Quantum Fast Access SCSI Hard Drive Upgrade and Controller Card.

Plus other contents as in the Amiga 1500 'Calculus' Starter Pack.

RRP - £1027.00

CALCULUS PRICE

£829.99 (£706.37 Ex VAT)

MULTISTART II - ROM SHARER

The MultiStart II allows you to install Kickstart V2.0 and V1.3 ROMs into your computer and switch between them with the keyboard. You can also install a third ROM on the MultiStart II. Being able to switch between 1.3 and 2.0 allows you to stay compatible with all your older software that won't operate under the new operating system. It's easy to install, with no external wires or switches required.

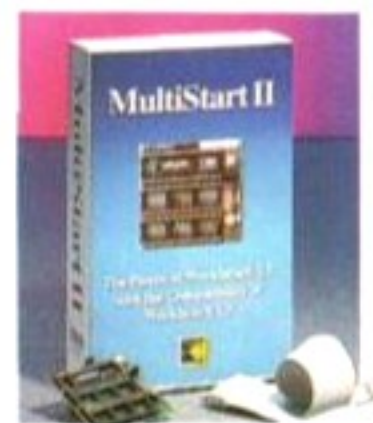

RRP - £49.99

CALCULUS PRICE

£34.99 (£29.78 Ex VAT)

AMIGA 1500 PVP VIDEO PRESENTATION

SYSTEM



FEATURES

Amiga 1500 Dual Drive Starter Pack with 52Mb Hard Drive, High Speed Controller
A2300 Internal Genlock
Scala Presentation Software + FREE Video
Amiga Vision Authoring Software and D Paint III Software
Also Available: 8Mb RAM Board with 2Mb RAM (Recommended for full SCALA use)

RRP - £1349.99

CALCULUS PRICE

£1079.99 (£919.14 Ex VAT)

AMIGA 1500 STARTER PACK

& 1085 STEREO

MONITOR



SAVE £200

Pack contents include the Amiga 1500 'Calculus' Starter Pack. Plus the new 1085s Stereo 14" Colour Amiga Monitor with Amiga Monitor Cables.

RRP - £999.99

CALCULUS PRICE

£799.99 (£680.85 Ex VAT)

ASK YOUR CALCULUS DEALERS FOR DETAILS OF OUR SPECIAL 12 MONTHS ON-SITE MAINTENANCE PRICE.

PHONE 0543 251275... FOR YOUR LOCAL STORE... PHONE 0543 251275...

AMIGA PERIPHERALS AND UPGRADES

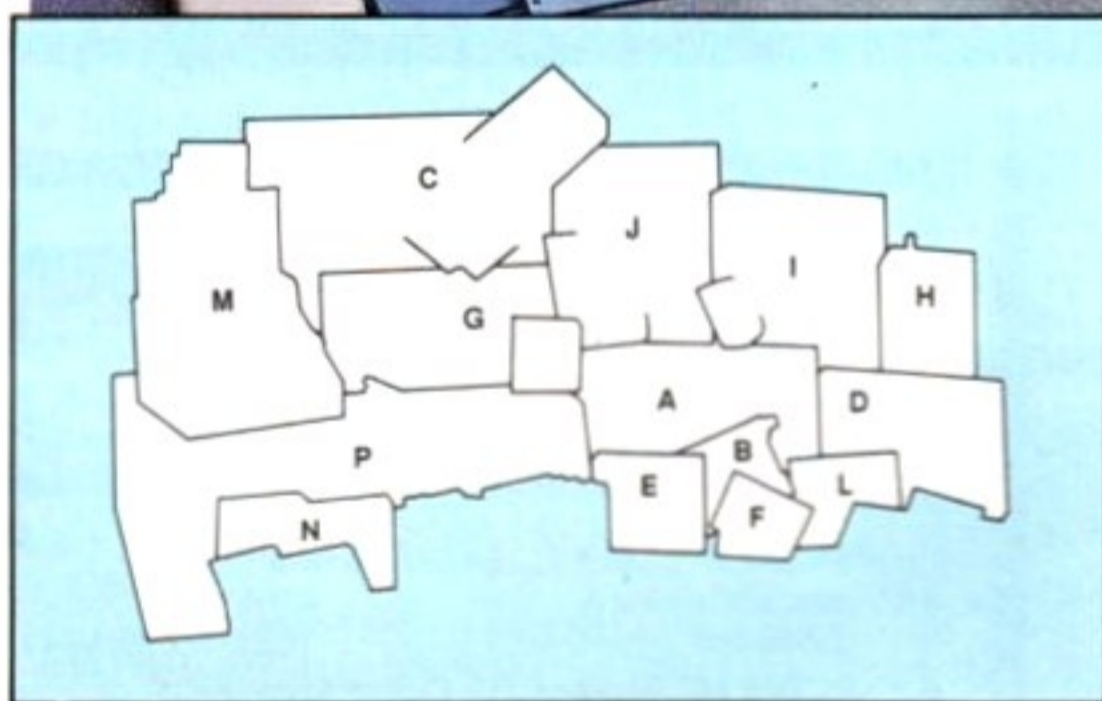

	INC VAT	EX VAT
A CUMANA CAX354 The Market leading 3.5" External Floppy Drive with enable/disable switch and through port facility suitable for use with the A500/500 Plus, 1500/2000 and A3000 series.	54.99	46.80
B CUMANA 500R Replacement Internal Floppy Drive for the Amiga 500/500 plus.	49.99	42.54
C SUPRA 500XP 52Mb External Fast Access Hard Drive with optional RAM upgrade for the Amiga 500/500 Plus. 105Mb Option also available.	339.99	289.35
DATAFLYER 2000S High Speed SCSI Controller for the Amiga 1500/2000 (Optional Hard Drive Available).	59.99	51.06
D DATAFLYER 2000AT High Speed IDE Controller for the Amiga 1500/2000 (Optional Hard Drive Available).	54.99	46.80
CBM 2091A Commodore High Speed SCSI Controller with Optional RAM Upgrade for the Amiga 1500/2000 (Optional Hard Drive Available).	139.99	119.14
E MICROBOTICS M501'S 512K Battery Backed RAM Upgrade for the Amiga 500/500 Plus. (Uses 16 Chip design for 100% compatibility).	24.99	21.27
F MICROBOTICS M502 1Mb Chip RAM Upgrade for the Amiga 500 Plus.	44.99	38.29
MICROBOTICS 8UP DIP (Picture not shown) 8Mb RAM Board with 2MB RAM Upgrade for the Amiga 1500/2000 (Upgradeable in 2Mb Steps).	139.99	119.14
G SUPRA RX 8Mb External RAM Upgrade with 2Mb RAM for Amiga 500/500 Plus. (Available with Additional RAM)	149.99	127.65
MICROBOTICS VXL 30-40Mhz (Picture not shown) 68030 Accelerator Board suitable for Amiga 500/500 Plus and 1500/2000. (VXL 30-25Mhz Board also available)	399.99	340.42

H AMIGA 500 PSU A High Power Output Power Supply Unit for the Amiga 500/500 Plus. (C64 Power Supply also available).	39.99	34.03
I GENIUS HAPPY MOUSE A High Quality Mouse suitable for use with the complete Amiga range (Excluding Amiga CDTV).	14.99	12.75
J GENIUS GENI-TRAC A High Performance 3 button Trackerball for Leisure and Serious uses. Suitable for all Amiga range (Excluding Amiga CDTV).	39.99	34.03
L QUANTUM LPS 52S A High Performance 52Mb SCSI Hard Drive with 17ms Access Time and Disk Cache. Quantum LPS 52AT - IDE Drive also available.	189.99	161.69
QUANTUM LPS 105S A High Performance 105Mb SCSI Hard Drive with 17ms Access Time and Disk Cache. Quantum LPS 105 AT - IDE Drive also available.	299.99	255.31
 ROM SHARER (Picture not shown) DKB Keyboard Switchable ROM Sharer for Amiga 500 and 1500/2000 (ROMS not included)	34.99	29.78
 GOLDSTAR 4905 (Picture not shown) A 14" Remote Control Colour Television/Monitor Complete with Amiga Monitor Cable.	179.99	153.18
 COMMODORE 1084S (Picture not shown) A 14" Stereo Monitor for use with the Complete Range of Amiga Computers Complete with Amiga Monitor Cable. LIMITED OFFER - FREE Amiga Vision Software - WHILE STOCKS LAST	249.99	212.76
M TDK 5 PACK TDK MF-2DD 5 Disk Pack Exclusive to Calculus Stores (4 Colour available)	4.99	4.25
N SONY 10 PACK Sony 10MD-2DD 10 Disk Pack	8.99	7.65
 BODEGA BAY EXPANSION SYSTEM The Bodega Bay fits into the side expansion slot of your Amiga 500/500 Plus and provides 4 x 2000 style expansion slots. The Bodega Bay also has enough space for two half height 5.25" drives and one 3.5" drive complete with a high capacity Internal Power Supply and Cooling Fan.	249.99	212.76

VISIT
YOUR LOCAL
CALCULUS
STORE FOR
A FREE
DEMONSTRATION

OVER ONE HUNDRED
AND FIFTY STORES
THROUGHOUT
THE U.K.
FOR MORE
INFORMATION AND
THE LOCATION
OF YOUR LOCAL
CALCULUS STORE
PHONE

0543
251275

COMPUTER DATABASE
OF CALCULUS STORES

ITEMS HELD IN STOCK MAY
VARY FROM STORE TO STORE

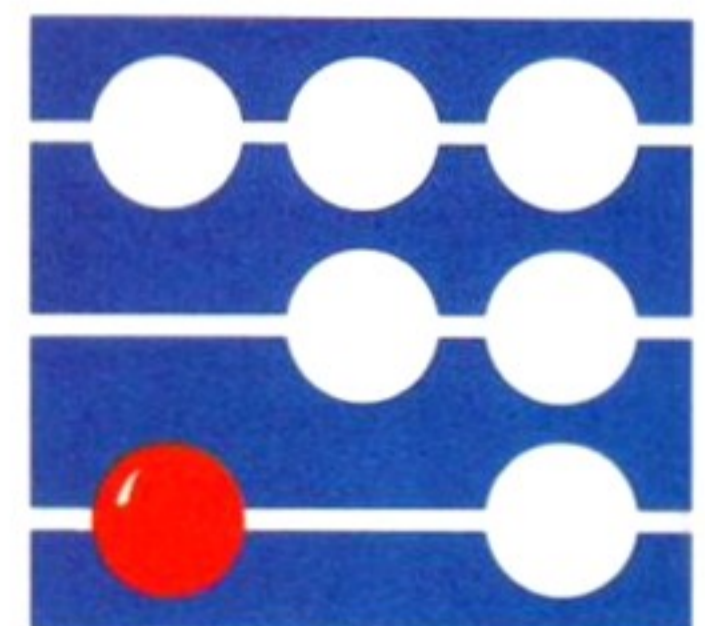

CALCULUS

COMPUTER STORES

YOUR LOCAL STORE... PHONE 0543 251275... FOR YOUR LOCAL STORE...

PROFESSIONAL AMIGA

AMIGA 2000

The Amiga 2000 has been designed as a basic system expandable to satisfy the needs of the home, business or professional user.

AMIGA 2000 HD 20

Amiga 2000 Dual Drive with 20Mb Hard Drive and Autobooting Controller Card. Amiga Vision Authoring Software.

RRP - £879.99

CALCULUS PRICE

£699.99 (£595.74 Ex VAT)

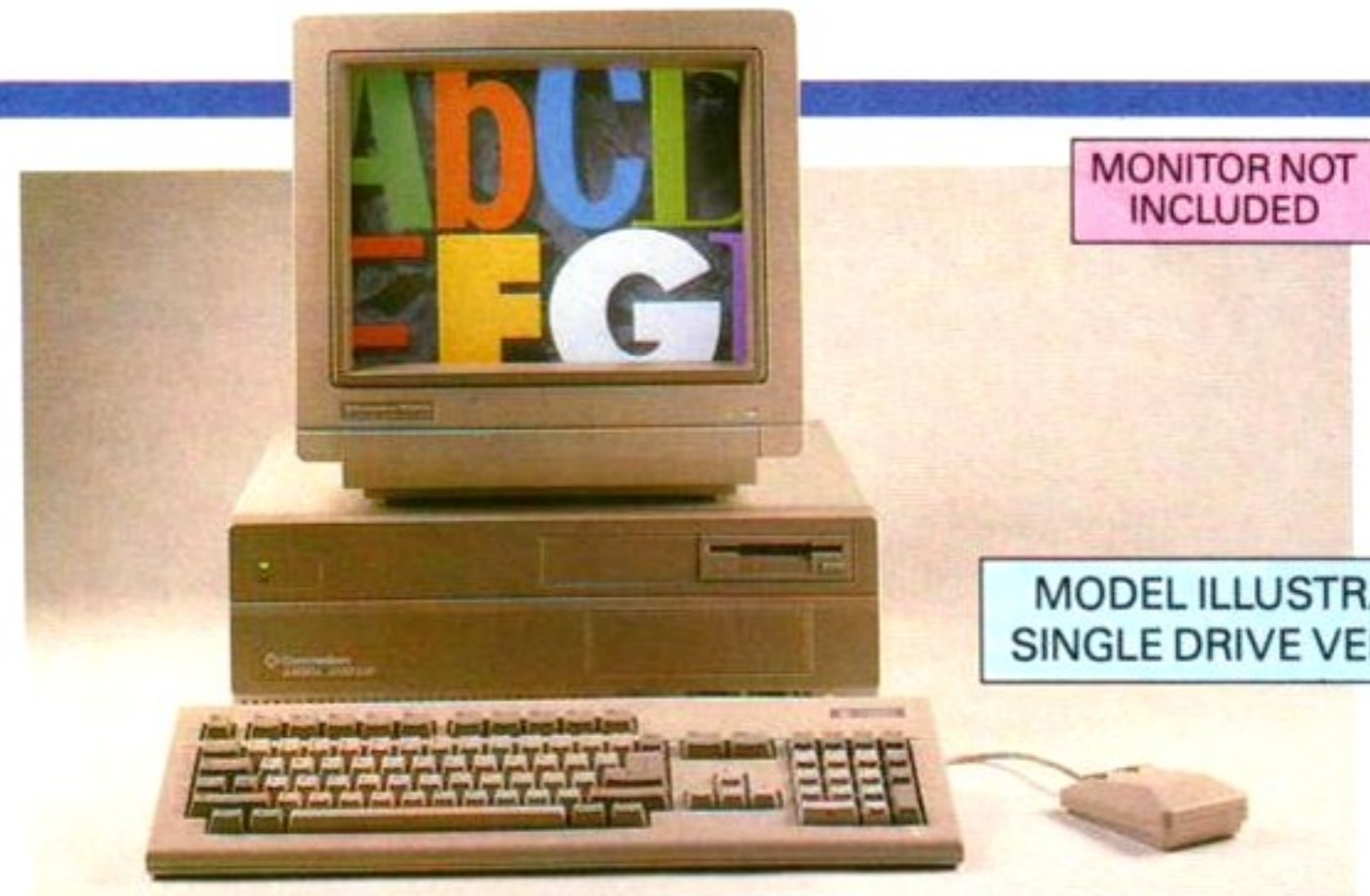

MONITOR NOT INCLUDED

MODEL ILLUSTRATED SINGLE DRIVE VERSION

AMIGA 2500 25Mhz HD52

Amiga 2000 Dual Drive with A2630 030 Accelerator running at 25Mhz
52Mb Quantum Fast Access Hard Drive with SCSI Controller
3Mb RAM (Includes 2Mb 32Bit Fast RAM)
Amiga Vision Authoring Software

RRP - £2198.00

CALCULUS PRICE

£1499.99 (£1276.59 Ex VAT)

ALSO AVAILABLE

105Mb Quantum Hard Drive Option 210Mb Quantum Hard Drive Option

AMIGA 2000 AND 3000

PERIPHERALS+UPGRADES

1084S CBM 14" Stereo CGA Colour Monitor with composite video	£249.99	(£212.76 ex VAT)
1085S CBM 14" Stereo CGA Colour Monitor	£219.99	(£187.23 ex VAT)
1960 CBM 14" Multi Sync Monitor <i>LIMITED AVAILABILITY</i>	£468.83	(£399.00 ex VAT)
21MP CBM 21" Multi Sync Monitor <i>VERY LIMITED AVAILABILITY</i>	£1526.33	(£1299.00 ex VAT)
25Mhz Microbotics VXL-30 030 Accelerator Board For 500/1500/2000	£269.99	(£229.78 ex VAT)
40Mhz Microbotics VXL-30 030 Accelerator Board For 500/1500/2000	£399.99	(£340.00 ex VAT)
A2630 25Mhz 030 Accelerator Board with 2Mb 32Bit RAM For 1500/2000	£669.99	(£570.20 ex VAT)
8Mb Microbotics RAM Board with 2Mb For 1500/2000	£139.99	(£119.14 ex VAT)
A2091 CBM SCSI Controller with 2Mb RAM Board (Optional RAM available) for 1500/2000	£149.99	(£127.65 ex VAT)
HF2000 Microbotics SCSI Controller with Drive Frame for 1500/2000	£139.99	(£119.14 ex VAT)
Dataflyer SCSI Controller Card with Drive Mount for 1500/2000	£59.99	£51.06
Dataflyer IDE Controller Card with Drive Mount for 1500/2000	£54.99	£46.80
2Mb Fast Page 32Bit RAM Upgrade For Amiga 3000 Series	£116.33	£99.00
A2300 CBM Internal Genlock For 1500/2000 and 3000	£89.99	£76.59
A3010 CBM 3.5" Internal Floppy Drive for Amiga 3000	£111.63	£95.00
A3015 CBM 3.5" Internal 1.44Mb Floppy Drive for Amiga 3000	£111.63	£95.00

AMIGA 2000 AT EMULATION HD52

Amiga 2000 Dual Drive with 52Mb Quantum Hard Drive with Controller Card
A2286 AT286 Bridge Board with 5.25" 1.2Mb Floppy Drive
Amiga Vision Authoring Software



SAVE £286 OFF NORMAL RRP

RRP - £1788.00

CALCULUS PRICE

£999.99 (£851.06 Ex VAT)

ALSO AVAILABLE

XT BRIDGE BOARD OPTION

AMIGA 3000 POWER UP

TRADE IN YOUR A1500 OR A2000

You know when the time is right, your trusty Amiga 1500 or 2000 has served you well but that 3000 makes your mouth water. Finding the cash isn't impossible but would be a lot easier if you could sell your Amiga for a sizeable sum. So, before you rush off to pen your advertisement, here's a proposition to stop you in your tracks... When you buy an A3000 from Calculus, we will give you what your Amiga is worth. No, not a second hand price but today's full Calculus retail price. So, with no strings attached, bring your working and Complete* Amiga 1500 or 2000 and power up to the amazing Amiga 3000.

ALL 3000 PROFESSIONAL SERIES INCLUDE FREE 12 MONTHS ON-SITE WARRANTY FOR TOTAL PEACE OF MIND

AMIGA 3000T 25/100

Amiga 3000T (Tower) running at 25Mhz
105Mb Quantum Fast Access Hard Drive
1Mb Video RAM and 4Mb Fast RAM
NOW INCLUDES FREE 12 MONTHS ON SITE WARRANTY FOR TOTAL PEACE OF MIND

SPECIFICATIONS:

- 68030 32 Bit Processor running at 25Mhz
- 1Mb Chip RAM
- 4Mb Fast Ram (Expandable to 18Mb)
- 52, 105, 210 and 425Mb Hard Drive Options
- 512Kb of 32Bit ROM
- 1x 3.5" Floppy Drive with 3x 5.2" Spare Drive Bays
- 8 System Slots featuring 1 CPU Slot, 7 Zorro III Slots with 2 Aligned PC AT Slots
- 8 Bit D/A Converter

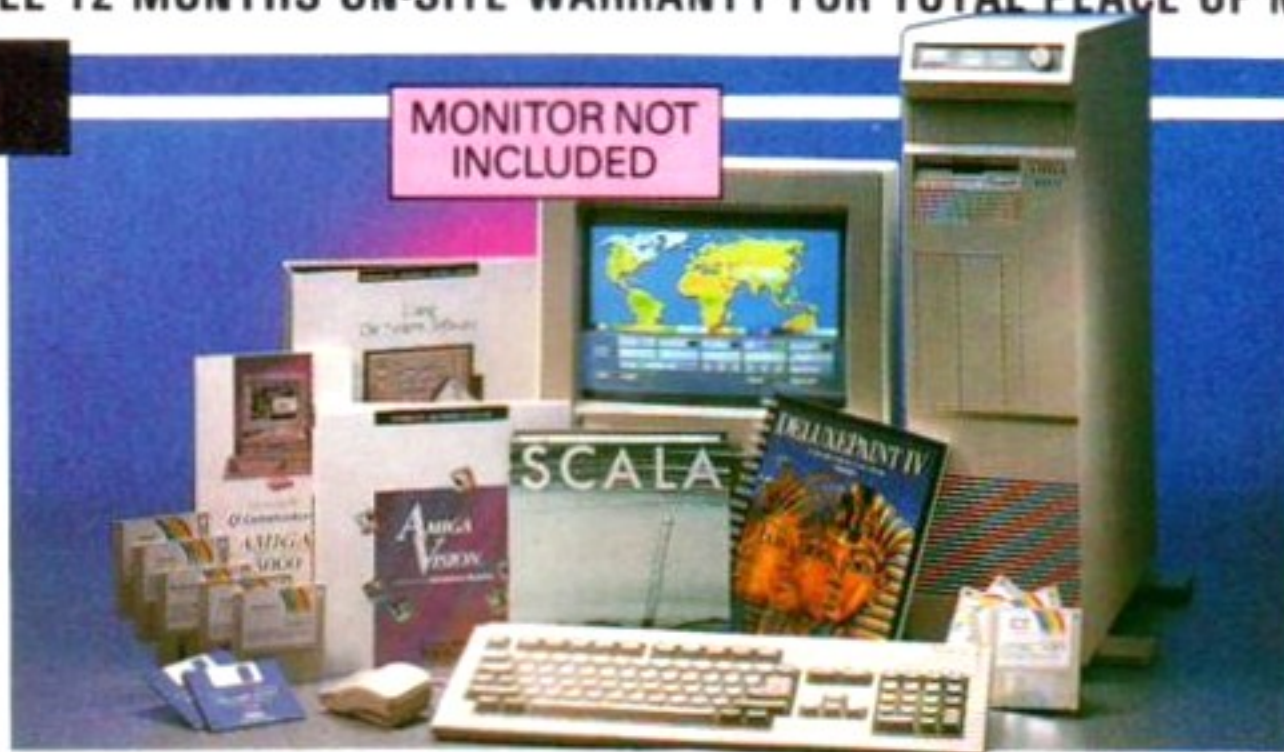

RRP - £3749.00

LESS YOUR
2000/1500 TRADE-IN
PRICE £1000.00

POWER UP PRICE

£2749.00

ALSO AVAILABLE

AMIGA 3000T 25/50

As above except 52Mb Quantum Hard Drive
RRP £3499.00
Less Your 2000/1500 Trade In £900.00
Power Up Price £2599.00

AMIGA 3000T 25/200

As above except 210Mb Quantum Hard Drive
RRP £3949.00
Less Your 2000/1500 Trade In £1000.00
Power Up Price £2949.00

Amiga 3000T 25/400

As above except 425Mb Quantum Hard Drive
RRP £4299.00
Less Your 2000/1500 Trade In £1000.00
Power Up Price £3299.00

FREE SOFTWARE WITH ALL 3000 SYSTEMS

DELUXE PAINT IV The industry standard paint package for all Amiga users, now with video and animation. Used with SCALA, you have the ability to introduce paintings, drawings, video and animation into your presentation.
Normal RRP - £89.99 inc VAT

SCALA The best presentation and video titling package available for applications in Multi-Media, Business presentation and video. Once you have used SCALA you will wonder how you ever managed without such a versatile application software package.
Normal RRP - £199.00 inc VAT

AMIGA VISION
A Multi Media Authoring system that brings together Video, Animation, Sound, Speech, Graphics and Text applications.
Normal RRP - £99.00 inc VAT



MONITOR NOT INCLUDED

AMIGA 3000 25/52

Amiga 3000 Desktop running at 25Mhz
52Mb Quantum Fast Access Hard Drive
2Mb Video RAM and 4Mb Fast RAM
NOW INCLUDES FREE 12 MONTHS ON SITE WARRANTY FOR TOTAL PEACE OF MIND

SPECIFICATIONS:

- 68030 32 Bit Processor running at 25Mhz
- 2Mb Chip RAM
- 4Mb Fast Ram (Expandable to 18Mb)
- 52, 105, 210 and 425Mb Hard Drive Options
- 512Kb of 32Bit ROM
- 1x 3.5" Floppy Drive with 1x 3.5" Spare Drive Bay
- 5 System Slots featuring 1 CPU Slot, 4 Zorro III Slots with 2 Aligned PC AT Slots
- 8 Bit D/A Converter

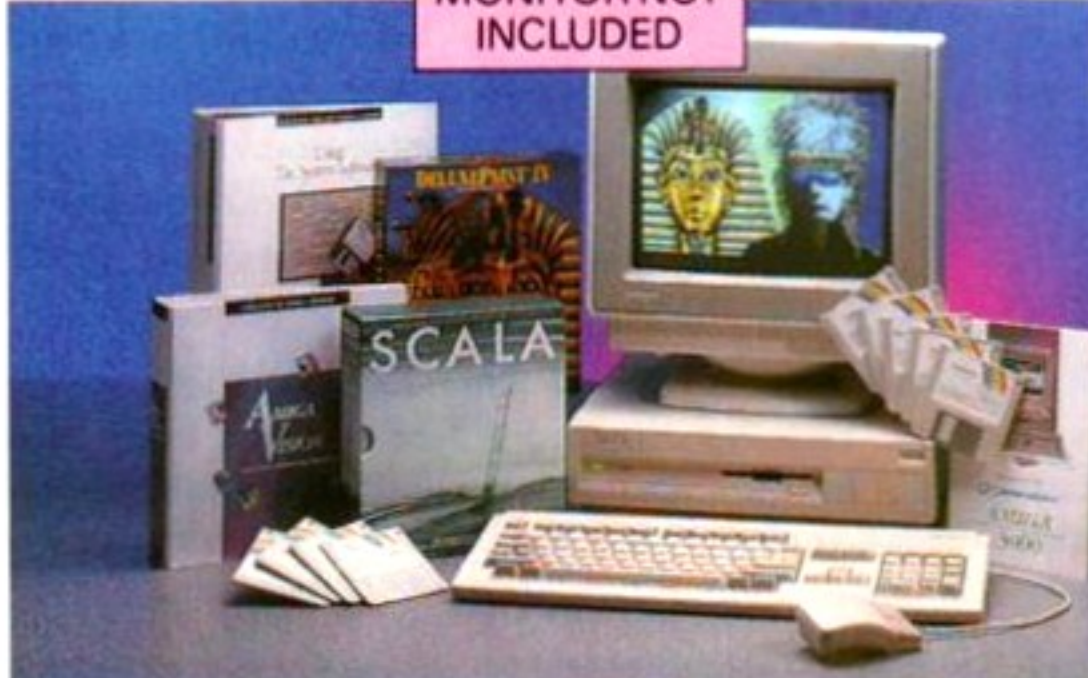

RRP - £2999.00

LESS YOUR
2000/1500 TRADE-IN
PRICE £800.00

POWER UP PRICE

£2199.00

ALSO AVAILABLE

AMIGA 3000 25/100

As above except 105Mb Quantum Hard Drive
RRP £3299.00
Less Your 2000/1500 Trade In £900.00
Power Up Price £2399.00

AMIGA 3000 25/200

As above except 210Mb Quantum Hard Drive
RRP £3499.00
Less Your 2000/1500 Trade In £900.00
Power Up Price £2599.00

Amiga 3000 25/400

As above except 425Mb Quantum Hard Drive
RRP £3999.00
Less Your 2000/1500 Trade In £1000.00
Power Up Price £2999.00

CALCULUS SELL MORE PROFESSIONAL AMIGA PRODUCTS THAN ANY OTHER U.K. RETAILER AND HAVE NOW BEEN APPOINTED BY COMMODORE TO MARKET THE NEW A3000 POWER UP PROPOSITION.

BEFORE ORDERING ANY PROFESSIONAL AMIGA PRODUCT PLEASE CONFIRM THAT THE RETAILER IS A CALCULUS STORE

* A1500/2000 must be in working order and complete with Keyboard, Mouse, System Disks and Manual.

ALL CALCULUS OFFERS ARE FOR THE MONTH OF PUBLICATION ONLY

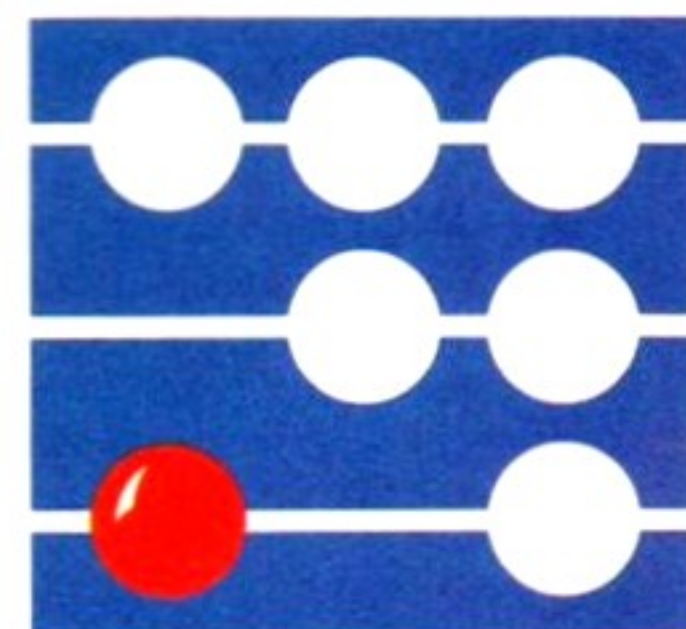

CALCULUS

COMPUTER STORES

YOUR LOCAL STORE...

PHONE 0543 251275...

FOR YOUR LOCAL STORE...

Fractal landscape generation programs just keep on getting better and better. Join **Marcus Dyson** as he takes a look at the new-and-improved version of an old favourite...



VistaPro 2

Fractal Landscape Generator ■ £69.95 ■

Virtual Reality Laboratories

IF YOU BOUGHT Issue 33 of **Amiga Format** you'll know all about *Vista*. We gave away that excellent landscape generation program as part one of the **Amiga Format** Collection (If you missed it turn to Page 156 now for an opportunity to get into fractal landscapes for a bargain-basement price). *VistaPro 2* is the latest version of the full-blown, all-singing, all-dancing True-Colour big brother of our Coverdisk program.

Of course if you didn't buy Issue 33, not only will you have no copy of *Vista*, but you also may have no idea of what this fractal landscape business is all about. For you people we'll quickly recap: fractal landscape programs use a combination of artificial intelligence and chaotic maths to create a picture that looks remarkably like the real world.

They start off with a file called a DEM (Digital Elevation Model) which is really a computerised Ordnance Survey map, the program then uses maths to work out what the terrain will look like. Whether it should have grass, rock or snow coverage, what the light and shade should be like etc, it will then draw out a picture. Of course you don't have to start with a DEM, you can use a random number as a fractal seed, and the program will create a landscape unique to that number. To newcomers this may all seem a little far fetched, but just take a look at the picture on the right if you find it hard to believe. This picture was created from scratch on the Amiga using *VistaPro 2*. It is a randomly-generated landscape, there is nowhere on earth that looks like this, unless of course, you know better.

When you first boot *VP2* it bears a remarkable similarity to *Vista*, well maybe it's not so remarkable because it is a direct descendant. The basic layout of the control panel is the same, map on the left side of the screen, push-button console on the right. One of the first things you'll notice, though, is that there are more buttons, a lot more buttons. This can only mean one thing, a lot more features. But what could they possibly have done to improve on a program that was already so massively good, let's take a look shall we?

One thing you're sure to notice is that the main control panel is displayed in interlace mode. All those extra buttons means *VP2* needs all that extra resolution, but don't worry about interlace flicker because it is only slight. The process of loading and saving a landscape

VISTAPRO 2 is available from HB Marketing 0753 686000

VistaPro 2 is available for £39.95 to readers who send in their **Amiga Format** Coverdisk 33.

The addition of trees (in four flavours) and buildings, along with the ability to control the altitude of the terrain make *VistaPro2* the best landscape generation program available to date.

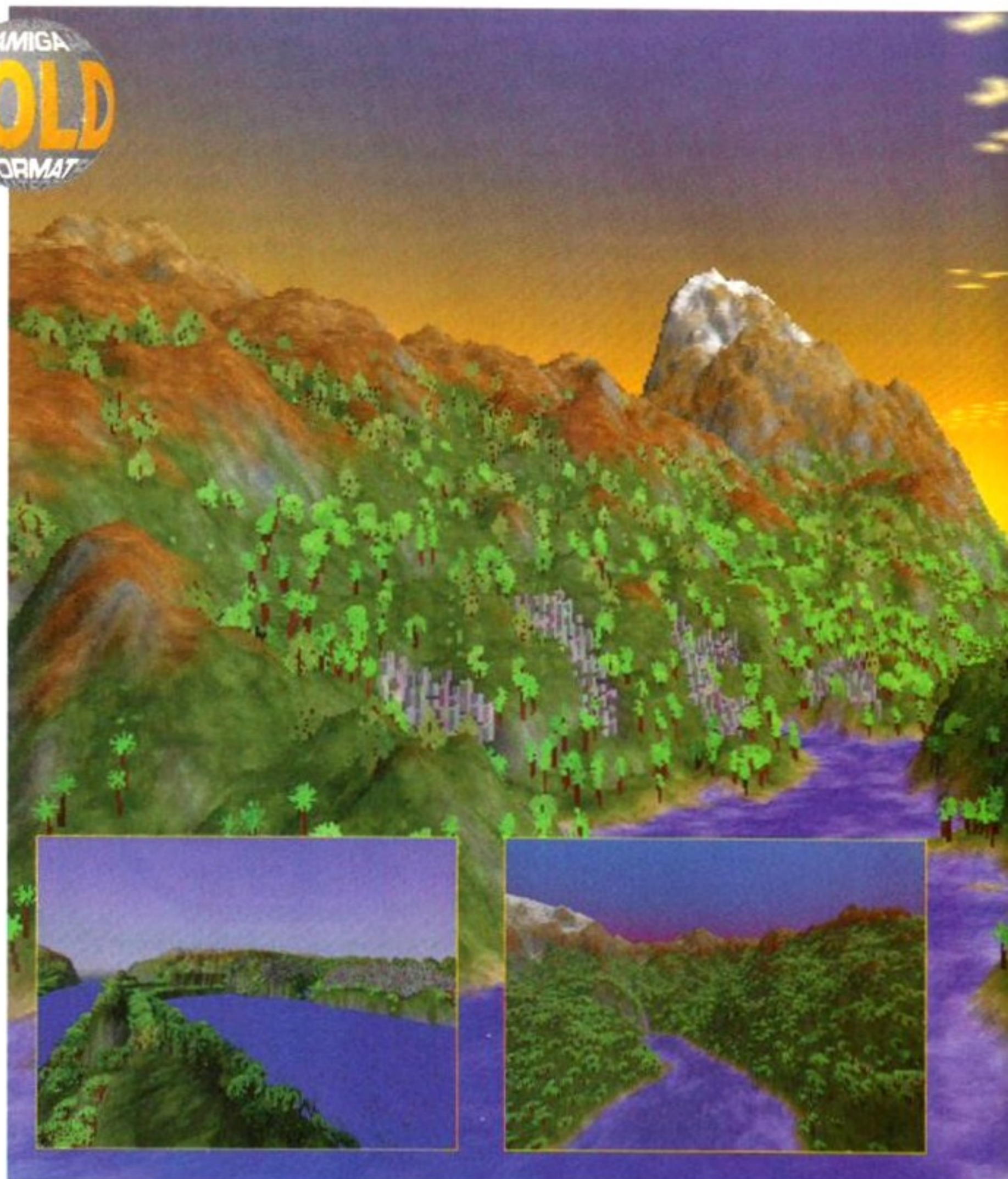

is exactly the same as *Vista*, it is the displaying and manipulating that varies greatly. Whereas *Vista 2* only allows the addition of coniferous trees to your landscape *VP2* goes not one, but three better, by offering you not only deciduous trees, but cacti and palm trees as additional options.

The addition of trees or buildings to a landscape can be heavy on processing time however, possibly lengthening a render by a

factor of 20. *VP2* is quite rapid though, even on a standard Amiga 24-bit pictures are rendered very swiftly. In fact, it is faster than *Vista*, even though it is working at a higher colour resolution. If you have an accelerator *VistaPro* will make capital of the fact. The disk contains two separate programs, one designed for a standard 68000 machine, and one for faster processors. Whilst they look and behave exactly the same, *VistaPro.881* can

IS THERE LIFE ON MARS?

VistaPro2 won't end the on-going debate about extra-terrestrial life, but it will give you a chance to look at some fairly alien scenes. The landscapes disk that accompanies the *VistaPro 2* program disk includes a file called *Mons.dem*, which is a landscape file of the Olympus Mons, a long extinct volcano on the surface of Mars.

Other files on the disk include *Julia.dem* and *Mandelbrot.dem*, both of which are landscape files created from fractal mathematic sets. These files show just one or two of the more unusual uses *VistaPro* can be put to.

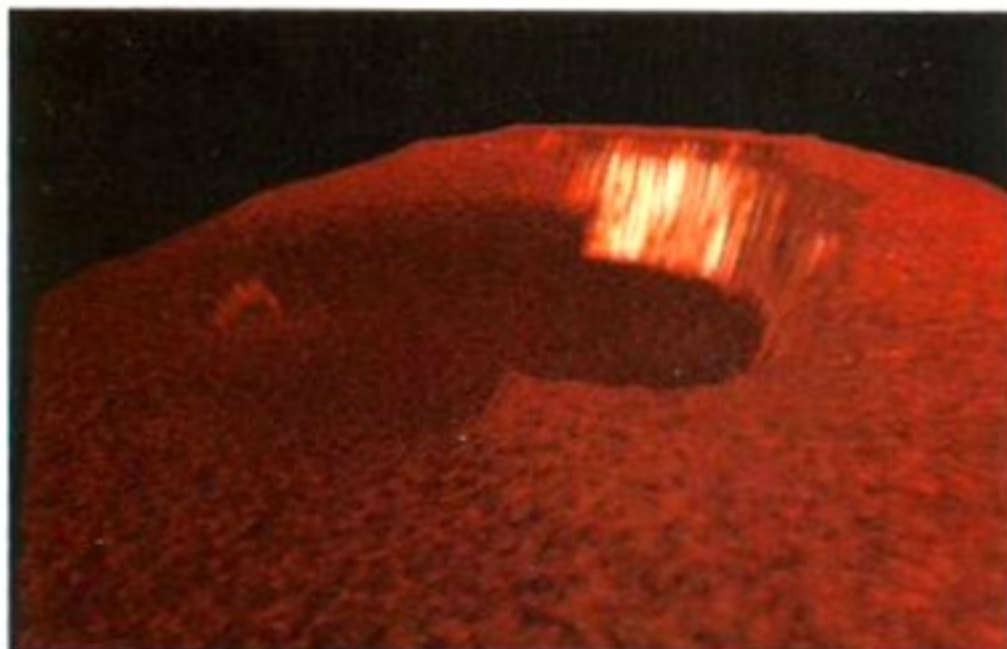

The 18km high (500km in diameter) Martian volcano Olympus Mons, as rendered by *VistaPro 2*.

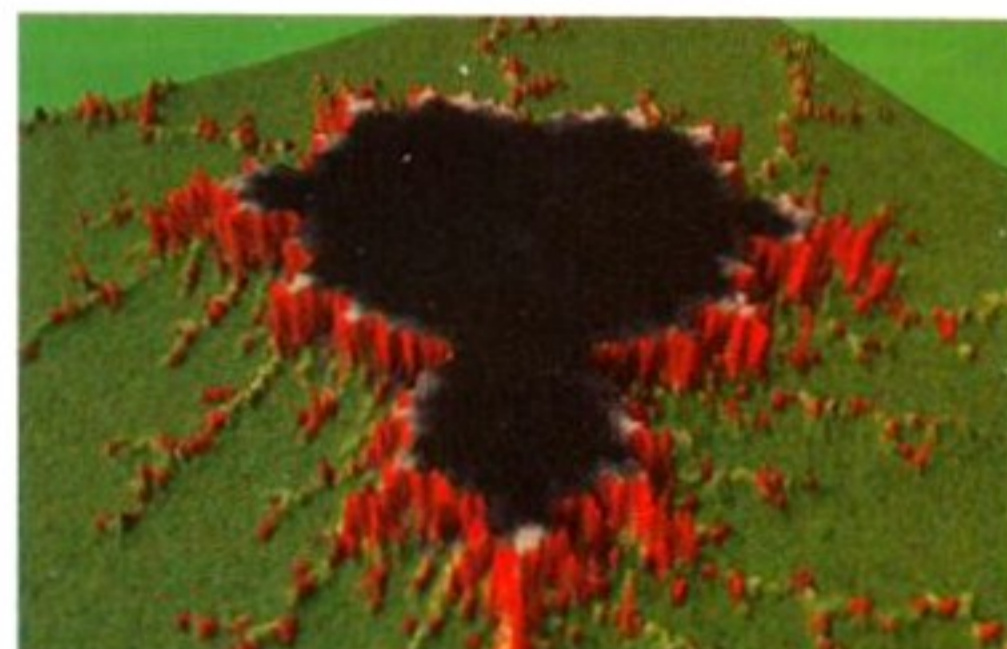

You won't find anywhere on earth as strange as the Mandelbrot set rendered as a 24-bit landscape.

TOTAL CONTROL

The top section of the control panel deals with the position of the camera (the place your picture is taken from) and the target (the place the camera is pointing towards). These items can be positioned in various ways, most simply by clicking on the appropriate gadget, then clicking on the map. The dr, dx, dy, dz and bank, head, pitch, range items tell you more about your camera's position in relation to the landscape.

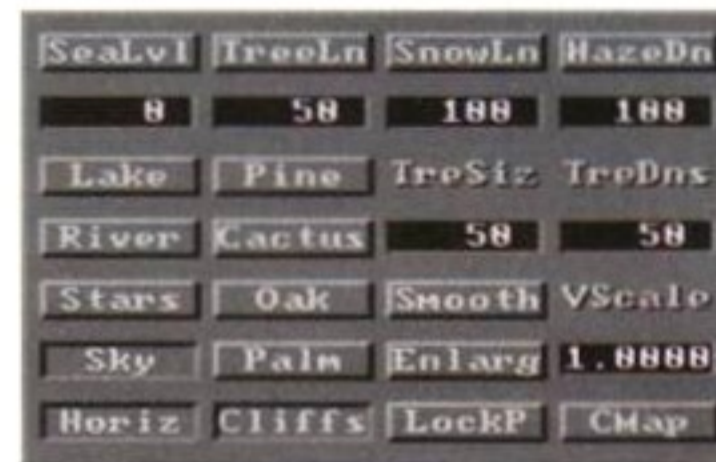

The middle control panel gives control over the features of the landscape. From here you can control the altitude of sea level and snow and tree lines. You can add lakes and run rivers through your landscape. From here you can also control the tree feature. The Cmap button at bottom right accesses the colour palette screen which is very important in determining the look of the land.



The bottom control panel changes according to which gadget is selected from the main panel. The main panel allows selection of the rendering parameters, like the polygon size, shading detail level etc.



The lens panel controls the angle of view in the scene. A small number, or wide-angle lens gives a wider angle of view. Thus a larger number gives a telephoto effect.

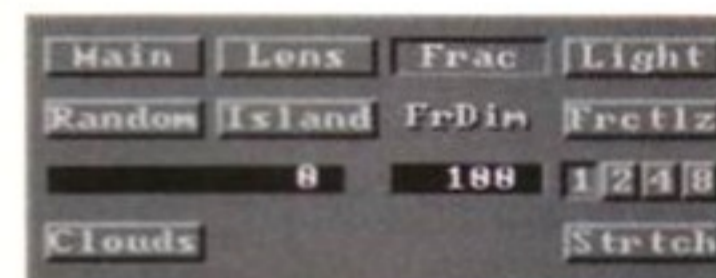

The fractal control panel allows you to control the creation of landscapes. The random button generates a fractal seed, a random number that effects the shape of the finished landscape. Other features in this panel help control the pseudo randomness of the generation process.

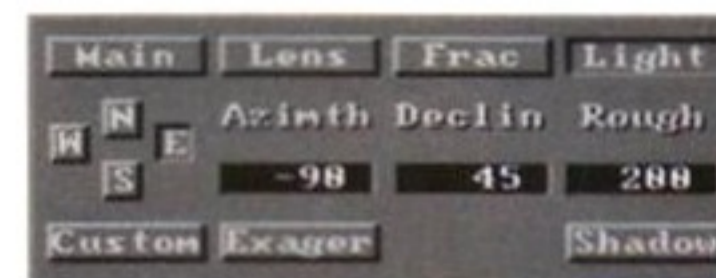

The light panel controls the direction of illumination on the landscape. It is vastly improved over the system used by Vista. The custom gadget allows the user to define direction and inclination of the light source with a single mouse click. The Exager button increases apparent intensity.

The top section of the control panel deals with the position of the camera (the place your picture is taken from) and the target (the place the camera is pointing towards). These items can be positioned in various ways, most simply by clicking on the appropriate gadget, then clicking on the map. The dr, dx, dy, dz and bank, head, pitch, range items tell you more about your camera's position in relation to the landscape.

The middle control panel gives control over the features of the landscape. From here you can control the altitude of sea level and snow and tree lines. You can add lakes and run rivers through your landscape. From here you can also control the tree feature. The Cmap button at bottom right accesses the colour palette screen which is very important in determining the look of the land.

The bottom control panel changes according to which gadget is selected from the main panel. The main panel allows selection of the rendering parameters, like the polygon size, shading detail level etc.

The lens panel controls the angle of view in the scene. A small number, or wide-angle lens gives a wider angle of view. Thus a larger number gives a telephoto effect.

The fractal control panel allows you to control the creation of landscapes. The random button generates a fractal seed, a random number that effects the shape of the finished landscape. Other features in this panel help control the pseudo randomness of the generation process.

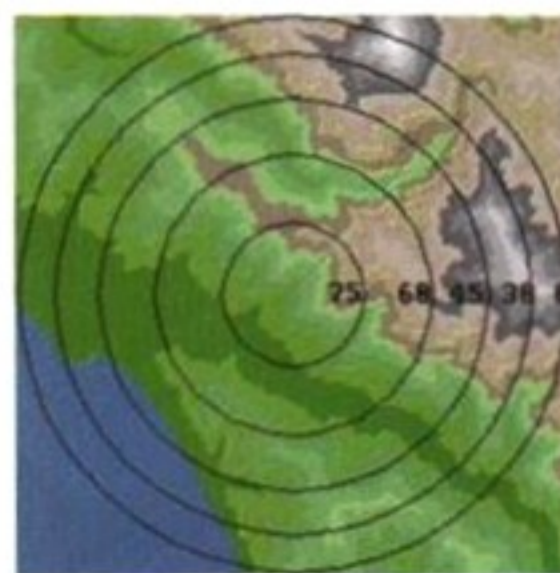

it in the same way. By doing this you effectively create your own contour map. This method allows you to control the shape of the terrain itself. Virtual Reality Labs have a program called *TerraForm* which can be used on a DEM file to shape the landscape as you wish. Files manipulated in *TerraForm* can be rendered in *Vista*. Sound interesting? then read the review on Page 154.

The real advantage of *VistaPro* over *Vista* is, of course, the fact that it works with 24-bit files. But you will have to have the necessary hardware if you want to display them on your Amiga. This doesn't have to cost you an arm and a leg because as well as supporting conventional 24-bit boards (like the Amiga Centre Scotland's *Harlequin*) VP2 also let's you use the *DCTV* and *HAM-E* budget True Colour systems. You don't need to have the ability to display 24-bit images to be able to use them though. You could import *VistaPro* 24-bits directly into a DTP program and output them to your printer as True Colour images. And that's exactly what we've done with the pictures on here, and I think you'll have to admit they are pretty impressive.

Possibly the most disappointing thing about the *Vista* family of programs has always been their weakness in the field of animation. Sure, it is possible to create an animation with *Vista*, but it involves writing a script to move the camera and re-render, then save a picture for each frame. Not the most simple way of doing it, that's for sure. It is for this reason that the program *Scenery Animator* from Natural Graphics has always been a worthy competitor to *VistaPro*. Virtual Reality Labs have addressed this problem though, and the *MakePath* program, which is an add-on to any of the *Vista* family of programs, is reviewed on the following page.

Its many features and ease of use set *VistaPro 2* at the top of the hill when it comes to landscape-generation programs. While Natural Graphics' *Scenery Animator* still has the edge in animation, *Vista* walks away with the medals in every other area of competition. If you enjoyed *Vista*, you'll love this.

VistaPro2

SPEED ●●●●●
Fractal landscape rendering is very processor intensive but *VistaPro* is as fast as they come.

DOCUMENTATION ●●●●●
There's nothing wrong with the manual, but a few more tutorials might be useful.

ACCESSIBILITY ●●●●●
The self-explanatory push-button control panel is a delight to use.

FEATURES ●●●●●
All you can get in the way of fractal landscapes, better animation would be nice though.

VALUE ●●●●●
Excellent value, especially if you're trading up from the *Amiga Format* April Coverdisk.

AMIGA GOLD 92% FORMAT

make use of the number-crunching power of an accelerator with a 68881 maths co-processor. This is very nice if you need to render 240-bit pictures in the twinkling of an eye, but as we said it's no slouch on a standard machine. The program will run from floppies too, though a hard drive is advisable, since 24-bit picture files can easily fill a whole floppy. The program files are archived so it has to be installed onto its own disks, but the procedure is fairly straightforward.

All this speed and flexibility has a price, to use *VistaPro 2* you will need at least 3Mb of RAM, and rendering in high-res interlace mode can require even more memory. But by today's standards this requirement is by no means excessive, many serious productivity programs require more.

One very neat addition is the ability to be able to save the ColorMap of a landscape out as an IFF, then you can manipulate it in a paint package, giving rudimentary control over the features of the terrain. This way it's possible to determine where trees, snow and cliffs will appear on the picture, and this is the only way you can tell the program where to place your buildings. It makes sense that the program doesn't make arbitrary mathematical decisions on the placement of buildings, although some very interesting landscapes would probably result. In addition there is the possibility to turn the altitude map into an IFF and paint on

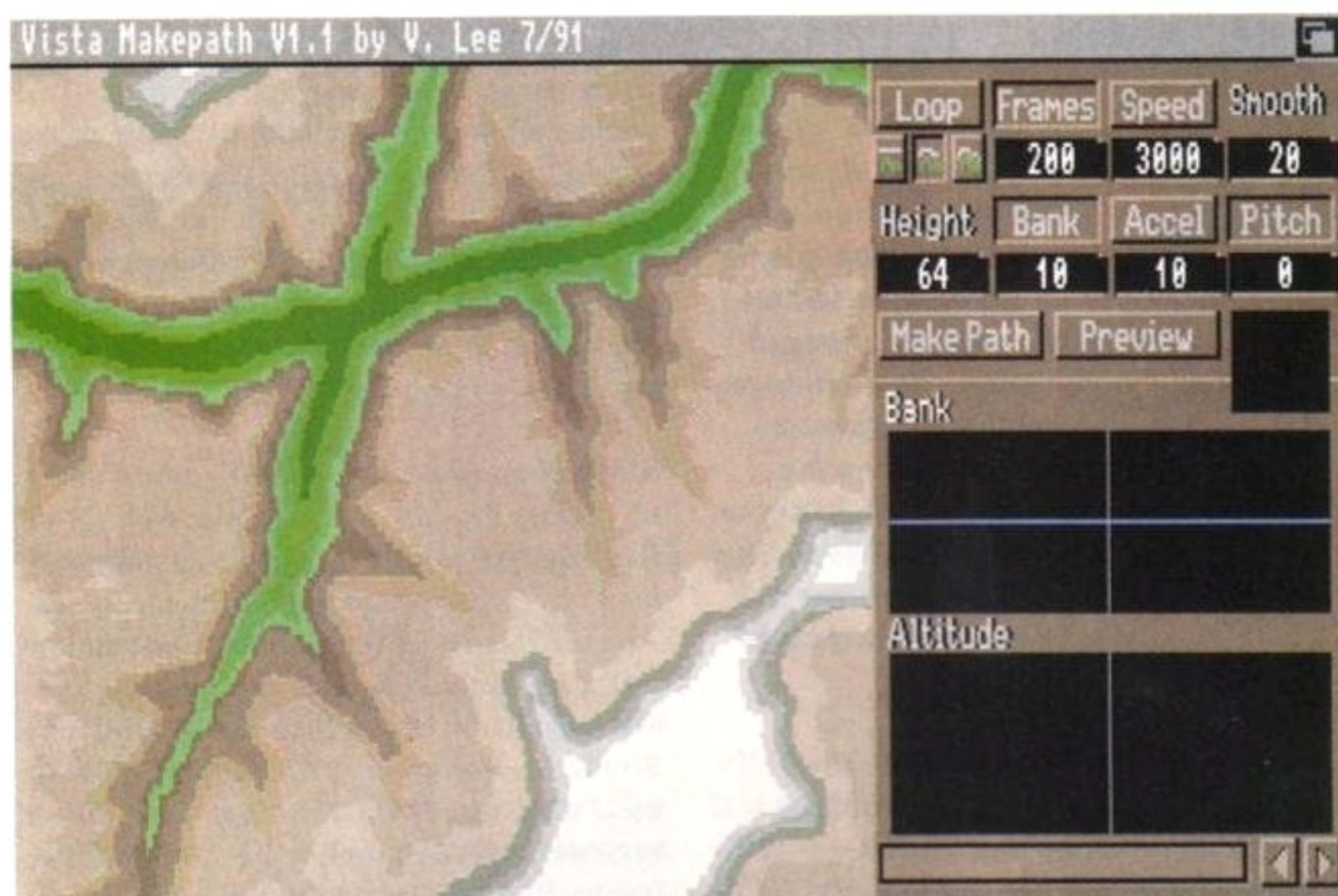

"It's very nice to go travelling (to London, Paris or Rome!) but it's so much nicer, yes, it's so much nicer if you can do it without having to leave home." Or something like that. **Marcus Dyson** discovers how to get around.

The *MakePath* control panel is very simple, but don't let that fool you. The program itself has very powerful features indeed!

dimensional curve, like the tubes that Bill and Ted's telephone box travelled through. You can define a spline using as many or as few editpoints as you wish, the minimum being two for obvious reasons. The number of editpoints does not effect the number of frames in the final animation, this is determined by a separate gadget. Once you have defined your motion path, and you can add or delete points at any time, you simply tell the program to *MakePath*, and that's exactly what it does.

If you want to check that everything is OK before saving your script, there is a preview button that will run through your anim in wireframe mode for you. Once you're happy with it you simply save it to disk as a script.

If you're looking for a *Top Gun*-style embellishment for your flight path, the program can automatically barrel roll for you. Once you have made a path, simply select the add-barrel-roll option from the menu bar, and *MakePath* asks how many frames of the anim you wish to spread the roll over. Then type in your reply and voilà! instant aerobatics.

If you are at all interested in creating animations with your *Vista* program, this is the way to do it. No more slavishly working out camera angles and positions and then painstakingly creating scripts. Just bish, bash, bosh, and loadsa-anims. But it really would be nice to see Virtual Reality Laboratories integrating this facility into *Vista* and *VistaPro* versions 3. Adding 30 pounds onto the price of the packages just to get animation is a bit hefty (especially when Natural Graphics *Scenery Animator* offers it in the price), but when it's this good it is difficult to complain.

AMIGA FORMAT

MakePath

Vista Animation Utility ■ £29.95 ■ Virtual Reality Laboratories

THE ONLY FAULT one can reasonably find with *Vista* (or *VistaPro* for that matter), is that the programs are a little lacking on the animation front. It's all very nice to be able to create stunningly realistic landscapes, but it would be so much nicer to zoom around them helicopter style, or that's what we think here in the **Amiga Format** offices. And it would seem that someone at *Vista*'s creators, Virtual Reality Laboratories, agrees with us, because they have just released *MakePath*, an addition to *Vista (Pro)* that brings powerful animation within reach of any user.

Previously to get *Vista* to animate you had to create a script (a simple computer program) telling *Vista* to move the camera and render and save a new picture, for each frame of the animation. Whilst it was possible to achieve impressive results using this method, it wasn't exactly simple to do so. *MakePath* changes all this by using a simple point-and-click interface. This allows you full control of camera motion, and when you're happy with your flightpath, it writes the *Vista* script for you.

Calling the *MakePath* motion a flightpath is a little deceptive, because although it can be a flightpath (Glider, Jet, Cruise Missile or Helicopter) it can also be a landbound route, either a Dune Buggy or a Motorcycle. The program has a given set of parameters which it will use to follow your animation route whilst acting with the characteristics of the chosen vehicle. For instance, selecting the Glider option will provide a very smooth animation with low rates of acceleration and banking, whereas the Dune Buggy option will provide a very bumpy animation as it hits every anticline and crevice of the terrain.

Creating a path is simply a matter of pointing and clicking on the map. Each click defines an edit point, which the computer joins together to form a spline. A spline is a three-

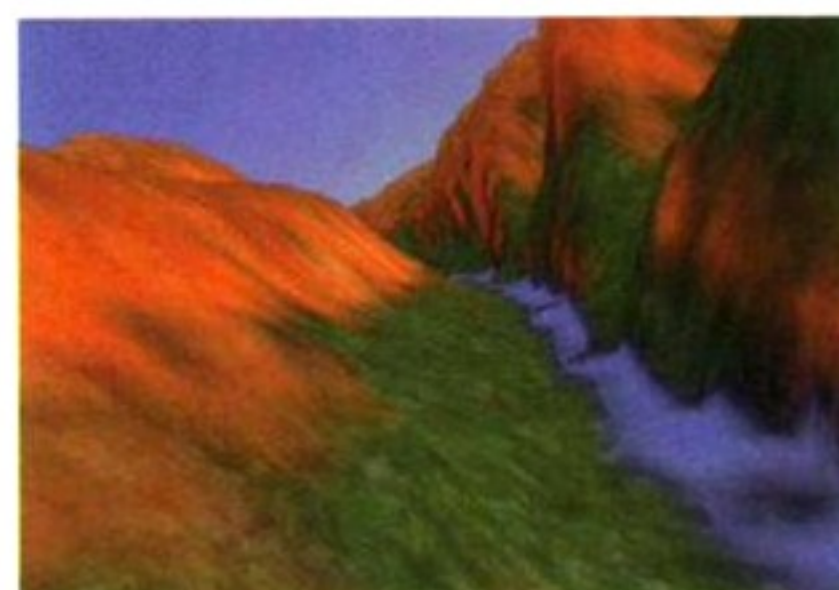

MAKEPATH is available from HB Marketing 0753 686000

If you've ever felt like going for a spin to somewhere exotic, *MakePath* could be the program you've been looking for.

VistaPro's stunning 24-bit images of the Grand Canyon take on a whole new life when seen in motion.

Creating a barrel roll is just one of the things that *MakePath* can do with consummate ease.

Mission accomplished, now fly back to base for a quick bit of romantic interest with Kelly McGillis.

MakePath

SPEED	● ● ● ●
The program runs very quickly indeed, no complaint in the speed department.	
DOCUMENTATION	● ● ● ●
A small and concise manual explains all of the program's features.	
ACCESSIBILITY	● ● ● ● ●
If you have any knowledge of <i>Vista</i> , there is no need to even open the manual.	
FEATURES	● ● ● ● ●
The features are few in number, but absolutely faultless in execution.	
VALUE	● ● ● ●
Not expensive, but it would be nice to see these facilities built into <i>Vista</i> .	

90%

500,000 COMPUTER GAMES

**SURPLUS STOCK SELL - OFF!!
TOP SELLING GAMES
FROM ONLY £1.00 EACH**

**AMIGA/ATARI
ST/PC/C64/SPECTRUM/AMSTRAD**

**JUST SEND ONE FIRST CLASS STAMP TELLING US WHAT COMPUTER
YOU HAVE AND WE WILL SEND YOU A FULL LIST OF AVAILABLE
SOFTWARE AT PRICES YOU JUST WON'T BELIEVE TO:
SURPLUS SOFTWARE SELL OFF**

DEPT.1, (DEPT AF) No 1 SATURN HOUSE, CALLEVA PARK, ALDERMASTON, BERKS. RG7 4QW

500,000 COMPUTER GAMES

THIS IS NOT P.D SOFTWARE, ALL GAMES ARE SHOP SURPLUS

TECHNOMANIA

Commodore Amiga A500+ Cartoon Classics Pack

3 Great Games
Lemmings (Psygnosis' Smash Hit)
The Simpsons versus the Space Mutants
Captain Planet and the Planetears

Also Deluxe Paint III (Electronic Arts Superb Art Package)
and 1Mb of memory.

£349.99

Commodore Amiga 1500

1 Megabyte of memory, two 3.5" disk drives
and the following software:
Toki, ELF, Puznic, Home Accounts
and The Works (integrated word processor,
spreadsheet and database)

£579.99

Commodore 1084D colour monitor

£729.99

MONITORS

Commodore 1085S£229.99
Philips CM8833 Mk2 (inc. cable, free copy
of F19 and one year on site
maintenance).....£239.99

PRINTERS. (all printers include cable)

Citizen 120D+£129.99
Citizen 124D£189.99
Citizen Swift 9 Colour.....£199.99
Citizen Swift 24E Colour.....£289.99
Citizen Pro-jet£399.99

Canon BJ10EX.....£259.99

Star LC20£149.99
Star LC200 colour£219.99
Star LC24-200 mono£259.99
Star LC24-200 colour£299.99

ACCESSORIES

Cumana CAX354 External Disk Drive£59.99
512K memory upgrade with clock.....£29.99
Microbotics M502 1Mb upgrade for A500+ .£45.99
Supra XR 8Mb Ramboard - populated
to 2Mb.....£149.99
Squik Replacement Mouse.....£14.99
Naksha Mouse with Operation Stealth.....£26.99

Dataflyer 500 fitted with 52Mb Hard Drive .£299.99

GVP Series 2 A500 52MB Hard Drive£379.99
GVP Series 2 A1500 52MB Hard Drive ..£289.99
Memory for GVP 1Mb.....£32.00

Bodega BAY expansion.....£249.99

KCS PC Emulator.....£219.99
Also available for A500+

Many other products available. Please phone for
a price on your specific requirement.

**All prices include
17.5% VAT and
Next Day Delivery
on Hardware**



**TECHNOMANIA,
13 WELLBURN STREET
DUNDEE, TAYSIDE DD2 2RR.
PHONE: 0382 22323 FAX: 0382 400444**



**Please allow five working
days for cheque clearance.
Prices are subject to
change without prior
notice. Orders received by
3pm despatched same day.**



Vista's fine if you're happy to render scenes from the real world, or random fractal landscapes, but until now actually controlling the lie of the land has been beyond the program. **Marcus Dyson** investigates a solution to the problem.

All the features of TerraForm are available from this screen. But the only feature the program has is to higher or lower the land, Populous manages to do that, and for a lower price.

TERRAFORM is available from HB Marketing 0753 686000

which case you click on the crater tool (rather humorously represented by a nuclear mushroom cloud) and then on the map. These tools both change the landscape (positively or negatively, respectively) by an amount controlled by the diameter of the brush, and the range of heights in the current map. Both these parameters are under direct user control.

A further set of diametrically-opposed tools can then be used to either roughen or smooth your landscape, according to your specific preferences.

Despite the controls being simple enough, it is fiendishly difficult to get exactly the result you desire, since the height a mountain will achieve depends on how quickly you cross the area the mountain occupies. If you paint slowly, the mountain becomes higher, if you paint quickly the mountain is a low one. Whilst this makes a row of mountains have a natural, range-like appearance, it can hinder precise landscape control. Using the brush function gives absolute control over the altitude, but doesn't draw realistic-looking hills, so it is only a partial solution to the problem.

Using the brush gives terraced hills, which are quite attractive, but not ideal for most uses. It is very good for adding structures to your landscapes though, dams are particularly easy, bridges unfortunately aren't

Whilst TerraForm may seem a worthwhile addition to your **Amiga Format** issue 33 coverdisk, I would recommend all would-be Slartibartfarsts to buy VistaPro 2.

VistaPro 2's ability to save the altitude map out as an IFF allows as much control over a landscape as TerraForm. And the program's other features make it an absolute bargain.

TerraForm

DEM Editing Utility ■ £29.95 ■ Virtual Reality Laboratories

EXTRAORDINARILY WONDERFUL AS the Vista programs are, they still only allow you to view and manipulate saved DEM files. They don't actually let you create your own DEM files from scratch, at least not with any precision. True, you can use the fractal landscape generation features of the programs, but the button that starts this feature operating says it all: Random. You can create a DEM, but this will produce a random landscape, with only minimal control over its features.

Aware of the artistic properties offered by Vista, Virtual Reality Laboratories have produced TerraForm, a program that lets you edit a landscape via a simple point-and-click interface. Once created in TerraForm a landscape can be saved as a DEM file for rendering in any of the Vista programs.

TerraForm is instantly identifiable as a member of the Vista family. But whilst the map is in the top left of the screen (the now familiar place for it), the control panel, which is usually on the right of the layout, is now at the bottom of the screen. Now the right side of the screen is occupied by a 3D view of a (user-definable) section of the map.

All the program's features are accessible via this screen, only file-handling tasks require the use of the menu bars.

TerraForm is essentially a paint program, but instead of applying colour to the picture the mouse pointer distributes areas of increased or decreased altitude. And rather than using an eraser to remove mistakes, you use a steam roller. Having touched on the subject of mistakes, it is worth mentioning that one thing the program lacks is an undo facility. If you do make an error, unless you have saved your landscape recently, there is virtually no way to correct it.

The control method is simple enough, just click on the mountain icon, then on the map. Unless of course you want to dig a hole, in

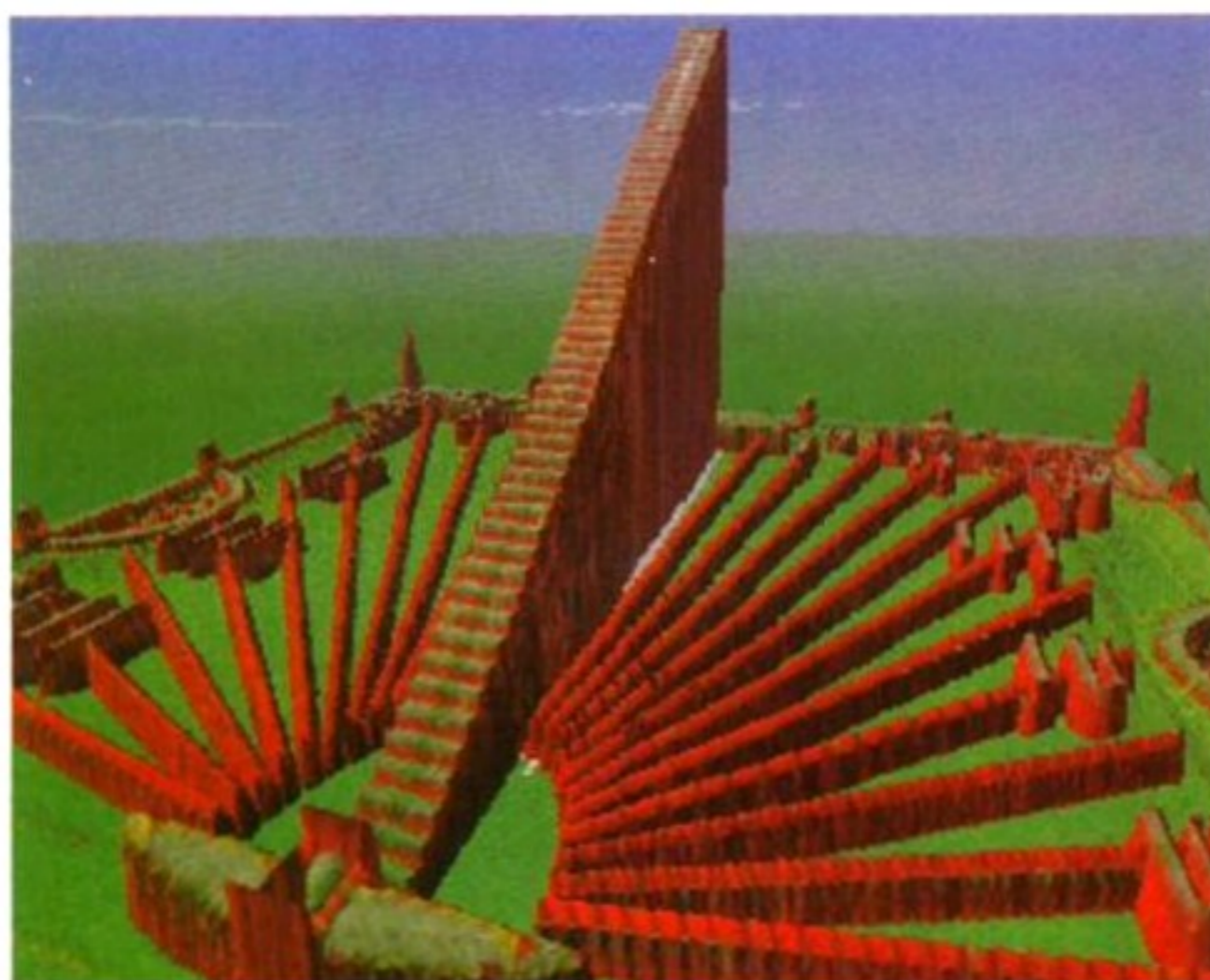

With practice it is possible to create stunning pictures with TerraForm, like this walled garden/sundial. One of the things TerraForm does best is add structural shapes like dams to a landscape.

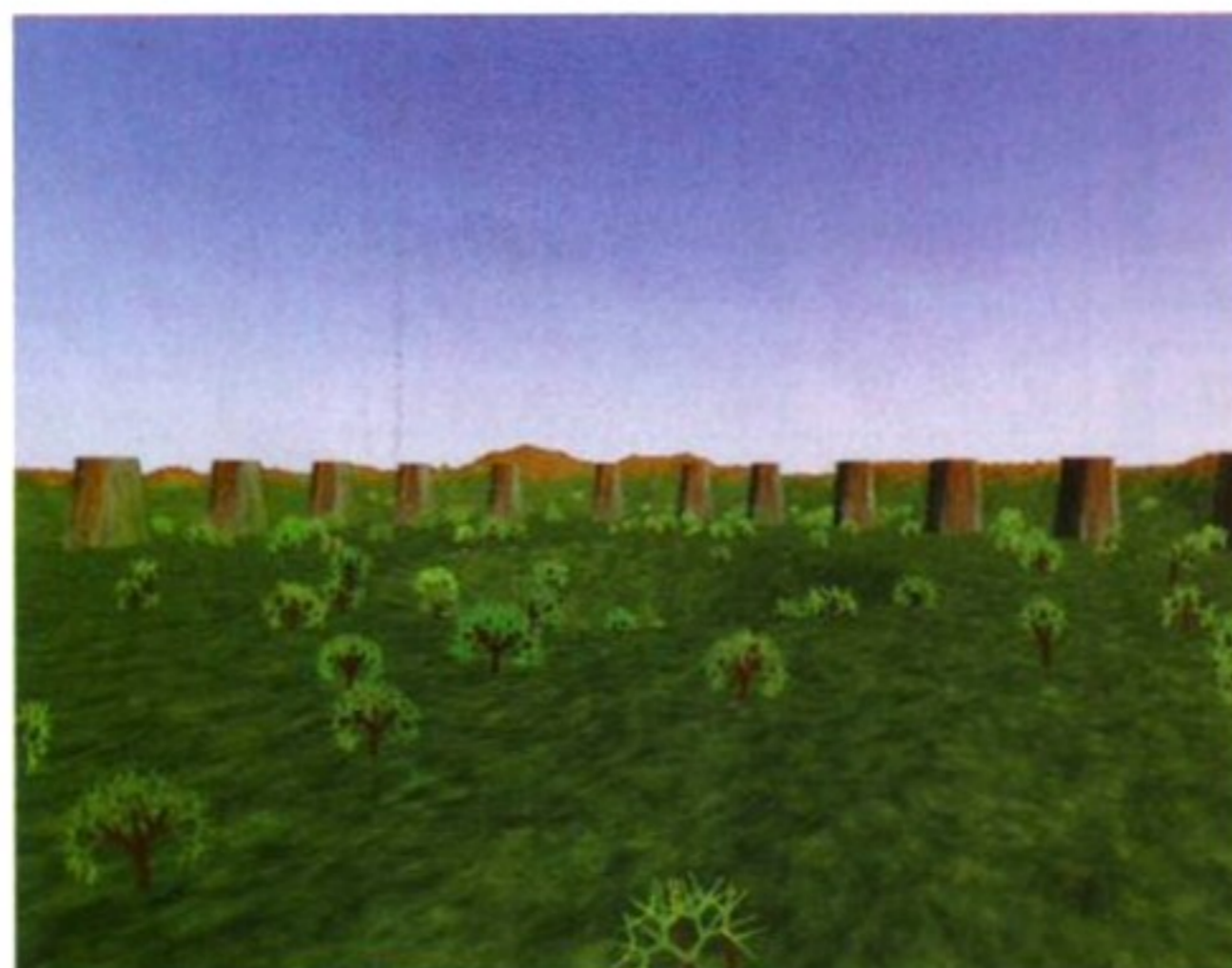

This stone circle is another example of TerraForm's capabilities, each monolith is 500 metres tall, the trees are 100 metres. Unfortunately you can't add lentils to the structures to make them truly Stonehenge style.

TerraForm

SPEED	● ● ●
Chugs a little when editing large areas of terrain, takes a while to catch you up.	
DOCUMENTATION	● ●
The flimsy manual fails to detail some of the program's functions, the two tutorials are basic.	
ACCESSIBILITY	● ● ● ●
A little playing with the program should see anyone becoming competent with the controls.	
FEATURES	● ●
It raises the landscape, it lowers the landscape... er, and that's about it.	
VALUE	● ● ●
If you don't have the money or the memory for VistaPro, then buy this!	

68%

GVP

GREAT VALLEY PRODUCTS

QUALITY AMIGA PERIPHERALS WITH A 2 YEAR WARRANTY

Silica Systems are pleased to present the GVP range of peripherals. GVP are the world's largest third party manufacturer of peripherals for the Amiga range and have a reputation for high specification, quality products. The company was founded only four years ago by a man who understands the Amiga - Commodore's ex-Vice President of Technology. He, along with a team of Amiga experts including other ex-Commodore staff, understand the add-on requirements of Amiga owners better than anyone. Not only do GVP provide peripherals that Amiga owners want, they also offer peace of mind, with a 2 year warranty on the products they manufacture. So, if you are looking for the very best in Amiga peripherals, look no further than GVP.

A530 ACCELERATOR

- 40MHz 68030EC processor
- Hi-speed SCSI interface with 52, 120 or 240Mb hard drive
- 1Mb Populated, Accommodates up to maximum 8Mb of 32-bit wide RAM
- Optional 68882 Maths Co-Processor
- Optional PC-AT emulation



FOR THE AMIGA 500

ACCELERATOR + HD + RAM UPGRADE

Plugging a GVP A530 Accelerator onto your A500 or A500 Plus will boost its speed from 7.14MHz to a blistering 40MHz. The A530 will be available with either 52, 120 or 240Mb hard drive and can be upgraded to include an additional maths Co-Processor, 8Mb of 32-bit wide FAST RAM and much more through GVP's unique "mini-slot".

40MHz-1Mb RAM/52Mb HD	Ref: HAR 0962	£749
40MHz-1Mb RAM/120Mb HD	Ref: HAR 0974	£899
40MHz-1Mb RAM/240Mb HD	Ref: HAR 0986	£1099

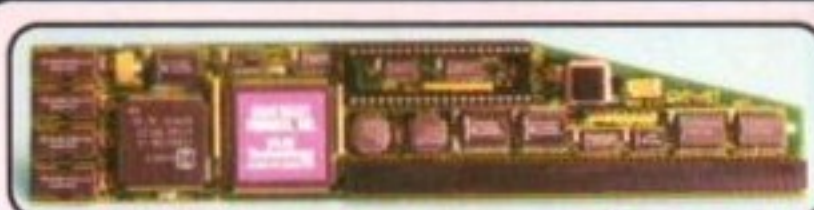

NEW! OPTIONAL PLUG-IN 16MHz PC286 EMULATOR

- 16MHz 80286 processor
- 287 Maths Co-Processor socket
- 512K of PC RAM plus the use of Amiga RAM
- Supports Hercules, CGA, EGA/VGA (monochrome) and T3100 video modes
- Runs MS-DOS (3.2 and upwards) plus thousands of other PC programs

This powerful 286 emulator module simply plugs into the "mini-slot" of the GVP HD8+ or A530 (without invalidating the warranty). The emulator has full access to the Amiga's resources and allows you to run PC and Amiga programs at the same time, giving you two computers in one.

£249
Ref: EMU 0500

- 52/120/240Mb LIGHTNING QUICK HARD DRIVES**
New State-Of-The-Art 1" internal SCSI Quantum hard drives, with a 1.100K per second (11ms) transfer rate making this the fastest hard drive available for the Amiga.
- LEADING EDGE TECHNOLOGY**
High-tech custom VLSI, Faast ROM chips and DMA design, ensure that no other Amiga hard drive will out perform the GVP HD8+.
- 8Mb RAM SOCKETS - UNPOPULATED**
Inside every drive there are sockets to expand the Amiga's RAM by 8Mb.
- USES EASY-TO-FIT 1Mb/4Mb SIMMs**
Memory upgrades. Please order MEM 3632 at £39.95 per Mb (2Mb jumps only), up to 4Mb. To upgrade to 8Mb, please order 2 MEM 3849 at £199.95 per 4Mb SIMM.
- CUT-OFF SWITCH FOR GAMES**
Features a special games switch to 'cut off' the drive for games that won't work with a hard disk. Most other drives require unbolting from the Amiga.
- "MINI SLOT" EXPANSION**
This unique slot has been built-in to allow expansion to be made without using any risky 'pass-through' techniques. See PC286 emulator above.
- EXTERNAL SCSI PORT**
Add up to 6 external SCSI devices, e.g. CD-ROM, tape streamers, additional hard drives, removable media, scanners, etc.
- DEDICATED PSU + FAN**
Following Commodore's strong recommendations, the GVP HD8+ is supplied with its own external power supply and cooling fan.
- FULLY COMPATIBLE**
Fully compatible with all Amiga 500's (inc. PLUS) and versions of Kickstart.
- FREE 2 YEAR WARRANTY**

WHAT THE PRESS SAY

'Superb build, excellent aesthetics and blinding speed make this the best A500 hard drive' ... - AMIGA SHOPPER
'GVP claims this is the fastest hard drive in the world and none of our tests could prove that wrong!' - AMIGA SHOPPER
'Overall: Untouchable. THE choice' - AMIGA SHOPPER
'Still the best hard drive' ... 92% - AMIGA FORMAT

120Mb
£499
REF: HAR 0920

240Mb
£799
Available 5/92
REF: HAR 0942

GVP HD8+ 52Mb HD

£379

ALL PRICES INCLUDE VAT Ref: HAR 0852



ALL PRICES INCLUDE VAT - DELIVERY IS FREE OF CHARGE IN THE UK MAINLAND

FOR ALL AMIGAS

AMIGA 1500 + 2000 + 3000 PRODUCTS

<p>SOUND SAMPLER</p> <ul style="list-style-type: none"> 8-bit stereo sampler Plugs into parallel port MIDI support for song input Extensive editing features Works with all Amigas <p>A low-cost sound and music solution for the semi-professional and audio hobbyist. It consists of a small, high quality 8-bit stereo sound sampler that connects into the parallel port on any Amiga 500, 1500, 2000 or 3000 computer. Combined with one of the fastest, most powerful and easy-to-use sound and music editing programs available. Includes 4-track soundtracker file compatible sequencer.</p> <p>MUS 2500 £59.95</p>	<p>G-FORCE 30-25/40/50</p> <ul style="list-style-type: none"> 68030EC/68030EC/68030 processor 25/40/50MHz clock speeds 68882 Maths co-processor Expands to 13/16/16Mb 32-bit RAM 32-bit SCSI controller on board <p>These fast 68030/68030EC accelerators with memory upgrade and SCSI interface board deliver uncompromising speed and performance without the high price. Each board comes complete with a 68882 maths co-processor and RAM upgrade as standard. Hard Disk Mount Kit available, to mount 1" Hard Drive on any G-Force 030 Board, GVA 4251, £39.95</p> <table border="1"> <tr> <td>25MHz/1Mb</td> <td>Ref: LPG 0110</td> <td>£599</td> </tr> <tr> <td>40MHz/4Mb</td> <td>Ref: LPG 0400</td> <td>£999</td> </tr> <tr> <td>50MHz/4Mb</td> <td>Ref: LPG 0530</td> <td>£1399</td> </tr> </table>	25MHz/1Mb	Ref: LPG 0110	£599	40MHz/4Mb	Ref: LPG 0400	£999	50MHz/4Mb	Ref: LPG 0530	£1399	<p>IMPACT II HCB</p> <ul style="list-style-type: none"> Factory installed Hard Drives 52, 120, 240 & 420Mb options On-board 8Mb memory sockets Add up to 6 additional SCSI devices Easy to install SIMMS <p>These are the equivalent of the HD8+ hard drive, but for the 1500 and 2000 models. Not only are they some of the fastest hard drives available, but they also incorporate an unpopulated 8Mb RAM expansion board.</p> <table border="1"> <tr> <td>52Mb</td> <td>Ref: HAR 1362</td> <td>£299</td> </tr> <tr> <td>120Mb</td> <td>Ref: HAR 1420</td> <td>£449</td> </tr> <tr> <td>240Mb</td> <td>Ref: HAR 1540</td> <td>£699</td> </tr> <tr> <td>420Mb</td> <td>Ref: HAR 1542</td> <td>£1299</td> </tr> </table>	52Mb	Ref: HAR 1362	£299	120Mb	Ref: HAR 1420	£449	240Mb	Ref: HAR 1540	£699	420Mb	Ref: HAR 1542	£1299	<p>IMPACT VISION 24</p> <ul style="list-style-type: none"> 768 x 580 PAL Resolution Supports composite video, S-VHS and RGB signals Broadcast quality genlock Now with RGB splitter <p>This is the very latest 24-bit Professional Video Adapter. It features 16 million colours on screen at once, built-in genlock, flicker fixer, frame buffer, frame grabber and digital keyer. Impact Vision 24 comes supplied with Caligari-IV24 3D modelling and rendering software. Scala IV24 video tiling software, plus Macro Paint 24-bit paint package. A1500/2000 requires additional adaptor, GVA 5224, £49.95</p> <p>VID 7024 £1699</p>	<p>RAM 8</p> <ul style="list-style-type: none"> Up to 8Mb of FAST RAM Upgrade in 2Mb increments Supports industry standard RAM chips Diagnostic software included Fully auto-configuring <p>A simple and convenient 8Mb RAM expansion board for the Amiga 1500 and 2000. Using industry standard RAM chips, the RAM-8 offers an easy way to upgrade your 1500 or 2000 in 2Mb increments. The RAM-8 is fully auto-configuring and is supplied with peace-of-mind diagnostic software. 6Mb configuration supported for bridgeboard owners</p> <table border="1"> <tr> <td>RAM 2800</td> <td>0Mb populated</td> <td>£99</td> </tr> <tr> <td>RAM 2802</td> <td>2Mb populated</td> <td>£169</td> </tr> </table>	RAM 2800	0Mb populated	£99	RAM 2802	2Mb populated	£169	<p>SYQUEST 44/88Mb</p> <ul style="list-style-type: none"> 44 or 88Mb removable media 20ms access time Can be supplied with or without GVP HCB Controller External case available for A500 or A3000 users <p>GVP are now offering Syquest drives with or without their HCB controller. They are available in 44 and 88Mb capacities and have a 20ms access time. Each drive comes complete with one removable cartridge. Syquest drives give complete storage flexibility, offering a quick and easy way to add extra storage to your system.</p> <table border="1"> <tr> <td>44Mb (Bare Drive)</td> <td>Ref: HAR 1054</td> <td>£449</td> </tr> <tr> <td>44Mb (+HCB)</td> <td>Ref: HAR 1058</td> <td>£549</td> </tr> <tr> <td>88Mb (Bare Drive)</td> <td>Ref: HAR 1070</td> <td>£599</td> </tr> <tr> <td>88Mb (+HCB)</td> <td>Ref: HAR 1071</td> <td>£699</td> </tr> </table>	44Mb (Bare Drive)	Ref: HAR 1054	£449	44Mb (+HCB)	Ref: HAR 1058	£549	88Mb (Bare Drive)	Ref: HAR 1070	£599	88Mb (+HCB)	Ref: HAR 1071	£699
25MHz/1Mb	Ref: LPG 0110	£599																																										
40MHz/4Mb	Ref: LPG 0400	£999																																										
50MHz/4Mb	Ref: LPG 0530	£1399																																										
52Mb	Ref: HAR 1362	£299																																										
120Mb	Ref: HAR 1420	£449																																										
240Mb	Ref: HAR 1540	£699																																										
420Mb	Ref: HAR 1542	£1299																																										
RAM 2800	0Mb populated	£99																																										
RAM 2802	2Mb populated	£169																																										
44Mb (Bare Drive)	Ref: HAR 1054	£449																																										
44Mb (+HCB)	Ref: HAR 1058	£549																																										
88Mb (Bare Drive)	Ref: HAR 1070	£599																																										
88Mb (+HCB)	Ref: HAR 1071	£699																																										

SILICA SYSTEMS OFFER YOU

- FREE OVERNIGHT DELIVERY:** On all hardware orders shipped in the UK mainland.
- TECHNICAL SUPPORT HELPLINE:** Team of technical experts at your service.
- PRICE MATCH:** We normally match competitors on a "Same product - Same price" basis.
- ESTABLISHED 12 YEARS:** Proven track record in professional computer sales.
- BUSINESS + EDUCATION + GOVERNMENT:** Volume discounts available for large orders.
- SHOWROOMS:** Demonstration and training facilities at our London & Sidcup branches.
- THE FULL STOCK RANGE:** All of your requirements from one supplier.
- FREE CATALOGUES:** Will be mailed to you with offers and software/peripheral details.
- PAYMENT:** By cash, cheque and all major credit cards.

Before you decide when to buy your new Amiga products, we suggest you think very carefully about WHERE you buy them. Consider what it will be like a few months after you have made your purchase, when you may require additional peripherals or software, or help and advice. And, will the company you buy from contact you with details of new products? At Silica Systems, we ensure that you will have nothing to worry about. We have been established for over 12 years and, with our unrivalled experience and expertise, we can now claim to meet our customers' requirements with an understanding which is second to none. But don't just take our word for it. Complete and return the coupon now for our latest Free literature and begin to experience the "Silica Systems Service".

MAIL ORDER HOTLINE
081-309 1111

SILICA SYSTEMS

MAIL ORDER:	1-4 The Mews, Hatherley Rd, Sidcup, Kent, DA14 4DX	Tel: 081-309 1111
Order Lines Open:	Mon-Sat 9.00am-6.00pm	No late Night Opening
		Fax No: 081-308 0608
LONDON SHOP:	52 Tottenham Court Road, London, W1P 0BA	Tel: 081-580 4000
Opening Hours:	Mon-Sat 9.30am-6.00pm	No late Night Opening
		Fax No: 071-323 4737
LONDON SHOP:	Selfridges (1st Floor), Oxford Street, London, W1A 1AB	Tel: 071-629 1234
Opening Hours:	Mon-Sat 9.30am-6.00pm	Late Night: Thursday until 8pm
		Extension: 3914
SIDCUP SHOP:	1-4 The Mews, Hatherley Rd, Sidcup, Kent, DA14 4DX	Tel: 081-302 8811
Opening Hours:	Mon-Sat 9.00am-5.30pm	Late Night: Friday until 7pm
		Fax No: 081-309 0017

To: Silica Systems, Dept AMFOR-0692-68, 1-4 The Mews, Hatherley Rd, Sidcup, Kent, DA14 4DX

PLEASE SEND INFORMATION ON THE GVP RANGE

Mr/Mrs/Miss/Ms: Initials: Surname:

Address:

Postcode:

Tel (Home): Tel (Work):

Company Name (if applicable):

Which computer(s), if any, do you own?..... 68C

Amiga Format back issues

ONLY £4 EACH!



ISSUE 9
Enter the exciting hyperworld of Multimedia.

ISSUE 14
The world of 'free' Public Domain software explored.

ISSUE 16
The first exciting look at the CDTV.

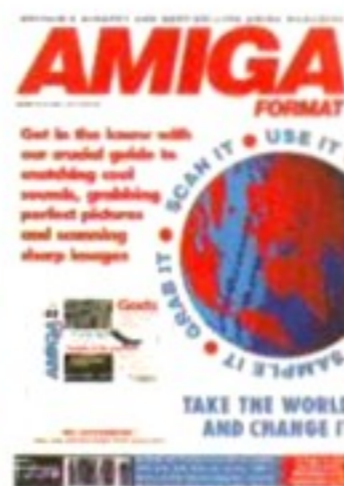

ISSUE 17
True colour: set to change the world?

ISSUE 19
Beginners: how to get your rights!

ISSUE 21
Learn which paint packages to buy, which to avoid!

ISSUE 22
Sampling, scanning and digitising made easy for you.

ISSUE 25
DTP: what it is and how you can do it on the Amiga!

ISSUE 27
True Colour graphics arrive: expensive, yes, but looks great!

ISSUE 28
How the graphics for games like *First Samurai* are made.

Amiga Format back issues with complete...

...full-price games



ISSUE 23
BALANCE OF POWER 1991
An all-time classic strategy game in which you control one of the super-powers aiming to avoid all-out nuclear war!



ISSUE 24
TWO COMPLETE GAMES!
VAXINE
Amazing 3D exploration and shooting game: weirder than weird!
ARCHIPELAGOS
Another 3D classic, with 10,000 levels and a fascinating challenge!

ONLY £5 EACH!

...creativity packages

ONLY £5 EACH!



ISSUE 30
WORTH £170
COMPLETE GRAPHICS AND MUSIC SOFTWARE!

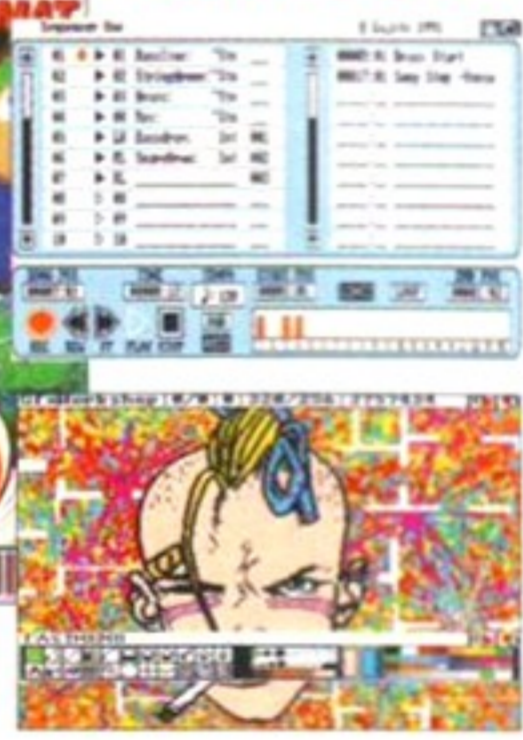

SEQUENCER ONE
Superb entry-level music sequencer: make your own tunes!
GRAPHICS WORKSHOP
A world-beating art-and-animation package, packed with features. 1Mb only.



ISSUE 33
WORTH £60
COMPLETE FRACTAL LANDSCAPE PROGRAM



VISTA
Create your own astonishing landscapes and save them as IFFs - Great for realistic scenery graphics, and fun too!

Amiga Power back issues with complete games

ONLY £5 EACH!



ISSUE 1: BOMBUZAL
A marvellously silly puzzle game packed with fun, frolics and large explosions! It's an all-time classic of its kind.



ISSUE 2: KID GLOVES
This classic platform game has just seen its sequel released, which just goes to show its timelessness!



ISSUE 34
WORTH £80
COMPLETE DESKTOP PUBLISHING PROGRAM
PAGESETTER 1.2



Create your own documents from scratch with this exciting program with its own built in Text and Graphics editors. Then print them to any preferences printer.

SUBSCRIBE!



...or we'll send someone round to explain the benefits!

All right, so it won't be us in person! But having the magazine pop through your letter box every month is like having an old friend come to visit. You're saved the hassle of the weary trek to the newsagent, you get the magazine before it officially goes on sale and now, for the first time, you'll also get a unique newsletter sent only to subscribers.

Please note: the price of subscriptions has now increased to account for the fact that every edition of Amiga Format from now on will cost £3.95 and come with a value-packed second Coverdisk on the front. Don't say you weren't warned! It's still a bargain, if you work it out...



Battle Isles
"A war game that breaks the mould and sets a new standard"
90% Amiga Format Issue 29

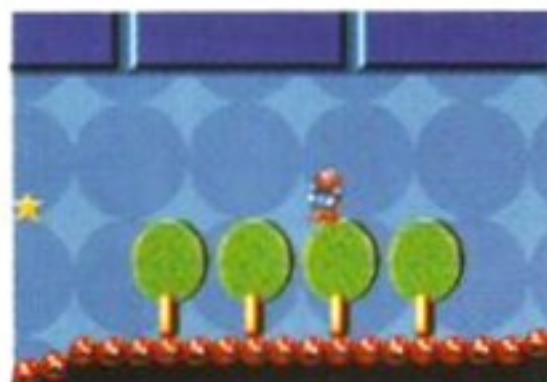

James Pond Robocod
"One of the best cutesy platform games ever to appear"
91% Amiga Format Issue 29



Home Accounts 1
Digita's DIY domestic budgeting system is still one of the most popular programs there is!

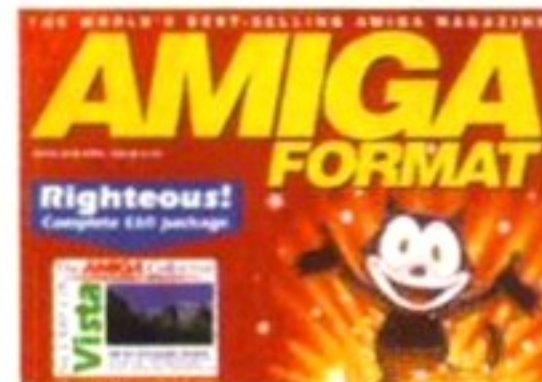

Two Free Issues
Alternatively, you can have the best free gift of them all - two issues of Amiga Format. They would cost you £7.90, but they are worth a lot more with the second disk containing a complete package worth at least £50.

Subscribe and choose one of these superb free gifts!

Amiga Format **Subscription** Order Form

Yes! Please enter/renew my subscription to Amiga Format and send me the software of my choice

(tick as appropriate) **UK £44.95** **Europe £74.95** **Rest of the World £104.95**

Battle Isles **Robocod** **Home Accounts** **2 Extra Issues**

Amiga Format back issues, £4 each. Issues 23, 24, 30, 33 and 34, £5 each

(please indicate the issues you require) _____

Amiga Power back issues (tick as appropriate) **1** **2** **£5 each**

Name _____

Address _____

Post code _____

Telephone No. _____

Method of payment (please circle) Access • Visa • Cheque • PO Total Order _____

Credit Card No. _____ Expiry Date _____

SEND THIS FORM TO:
Amiga Format Subscriptions,
Future Publishing Ltd,
Somerton, Somerset,
TA11 6TB

Please make all cheques payable to
Future Publishing Limited.
This coupon is valid until
the end of June 1992 AF/MAG/06



AMIGANUTS UNITED

169 DALE VALLEY ROAD, HOLLYBROOK, SOUTHAMPTON, SO1 6QX.
AMIGANUTS UNITED AUSTRALIA - 199 TAYLOR ST, TOOWOOMBA, QLD, AUSTRALIA 4350. WORLDWIDE
DISTRIBUTORS OF THE DEDICATED AMIGA CODERS CLUB DISKS.
EUROPEAN DISTRIBUTOR FOR THE T.BAG DISKS.
Numbers 1 to 63 NOW AVAILABLE.



ALL ARE V2 COMPATIBLE - V2 COMPATIBLE PROGS ALSO DENOTED IN OUR CATALOGUE. MAIL ORDER ONLY - IF MAKING AN ENQUIRY, PLEASE ENCLOSE S.A.E.

INTO MUSIC? THEN THE EIGHT CHANNEL MIDI COMPATIBLE OCTAMED V2 IS FOR YOU! CONTAINS FULL NOTATION WITH NOTATION EDITOR, (STAVES), PRINT FACILITY PLUS 16 TRACK DISPLAY FOR MIDI USERS. IT ALSO HAS ITS OWN BUILT IN SAMPLER. ALL THIS FOR £80.00 (NOTE THAT YOU DO NOT NEED A MIDI KEYBOARD TO USE THIS EXCELLENT MUSIC PROGRAM).

THE OCTAMED MANUAL IS HERE!!!

Authorised re-write which will show you what an excellent utility it is. Parts also cover the earlier Public Domain Med program as well. Send for your copy now!

ONLY £9.95

INTO CODING? - NEW TO COMPUTING AND WANT TO LEARN? - THIS CLUB IS FOR YOU! IF YOU WANT TO LEARN HOW TO ASSEMBLE THAT STRANGE LOOKING CODE, YOU NEED US. AMIGA CODERS CLUB IS NOW BEING SOLD WORLDWIDE, SO WHY NOT FIND OUT WHY THEY ARE SO POPULAR FOR YOURSELF? EACH ISSUE CONTAINS LOADS OF SOURCE READY TO ASSEMBLE AND IS ALSO PACKED WITH HELP, TIPS, CONTACTS, LETTERS, PLUS ADVICE. ACC IS PUBLISHED MONTHLY AND IS AVAILABLE FOR THE LOW PRICE OF £4.00 PER ISSUE. OUR SPECIAL INTRODUCTORY COMPRESSED ACC DISK 1 TO 4 IS ONLY £2.00, SO ORDER YOUR COPY NOW!

- 1038: Amidash is a boulderdash clone that deserves to be in your collection £3.00.
- 1199: Amnuts text/video displayer. A brilliant new way to display your text!
You can use different fonts in the size you choose, control the colours and presentation of the display, search for a given word, print out the whole file or just the screen etc, etc., It will even load crunched powerpacked files! £8.00
- 1201: The delightfully crazy and fun hotdog game. Can you get through? £4.00
- 1206: Storyland. A truly excellent childrens program and a must have! £3.00
- 1214: Scrazzle. Enjoy playing the game with a similar name? You'll love it! £4.00
- 1232: Golf Recorder V3. The latest version for all golf enthusiasts (3 disks) £7.00
- 1233: A-Vian Demo from the author of A. Gene, this one is for pidgeon breeders. £2.00
- 1235: Bingo. Will print your bingo cards and then run the program. Excellent! £4.00
- Amibase Professional III. The additions to this new two disk version Database are excellent, (see reviews). Also contains a converter to alter files saved with the previous version. Only £10.00 EC or £15.00 ROW (remember the postage).

Postage for all EC Countries, (including U.K.), Add 50p - Non EC £1.50
Orders from overseas customers must be by Bank Draught, Postal or Eurocheque.
(Sorry but we do not accept credit card orders as these would push up prices). The 1992 catalogue is available now!! £1.50 (don't forget to add postage).

PROGRAMS COMING SOON FROM AMIGANUTS

INTUISYS ★ A-GENE V4 ★ OCTAMED PROFESSIONAL ★ AMICASH PROFESSIONAL
Further details on release date and prices to be announced.
WATCH THIS SPACE

AMIGA FORMAT

158 JUNE 1992

KINGSTON, SURREY

Major stockist for all Commodore products including Amiga and CDTV.

Over 2,000 sq. feet of computer software and hardware for Commodore, Atari and PC.

Our enthusiastic staff also insist that we stock a complete range of Sega, Nintendo and Lynx consoles.

NEW STORE OPENING SOON!

BARKMAN COMPUTER SERVICES
First Floor, Cardinals Market Place,
Kingston, Surrey.
081-546 5941

Beaugh's British Domain

Phone for PD Catalogue

P.O. Box XG 14
Leeds LS14 6XR
Tel: (0532) 642 550

☆ AMIGA 500 & 500 PLUS ☆

The **KEW = II** Collection



P.O. BOX 672
South Croydon
Surrey CR2 9YS

NO MODEM? WE CAN FILL THAT GAP!

All the latest updates plus all your old favourites - tested on the 500 and the 500 plus - of Public Domain and Shareware.
Demos, Games, DataBases, SlideShows, Printing, WordProcessors, Music, Art, Anims, Programming, Comms, Text, Players, Readers, Viewers, Virus detectors & killers plus an unbelievable number of easy to use utilities. All programs are supplied with full help for installation and use. All disks 100% virus and error free. Send P.O/Cheque £1 for your membership pack. 24hr members answerphone.

ONLY £1

SEND NOW FOR CATALOGUE DISK AND PRINTED INDEX

TDM SLIDESHOW GENERATOR
17 BIT 1804



The front panel of this slideshow creation utility is a bit confusing, but with some trial and error (the included demo slideshow helps) most of it becomes clear quickly.

Slideshow generators are programs to help you create slideshows without a lot of previous knowledge. They save you the hassle of writing a fiddly AmigaDOS script file and using a picture viewer like the PD *Vilbm* program. This one, although not the best I've seen, does have a number of features that make it worthy of mention.

But first, a word of warning. This TDM offering has very little in the way of documentation, so be prepared to sit down and play with it for a while to discover its subtleties. You will need to know a little about startup-sequences and such – if you have been following the Beginners series you should be all right.

Now the good news. It lets you incorporate pictures of all standard Amiga resolutions and sizes into a slideshow. It also has some wipes built in (to smoothly go from one picture to the next). You can add background music too. Best of all, though, is the front end. At first, it looks a little daunting, with gadgets to click

PD Update

The best new shareware and freeware utilities currently available in the Public Domain, amply enthused over by **Pat McDonald**.

on everywhere. After a while though (a demo slideshow is included to help start you off) most of the functions become pretty obvious. The program has some on-line help, to give you a few insights into how it all works.

If you're not a pure beginner anymore and want something to cut your teeth on, making a slideshow with this program could well prove to be an enlightening project. As a bonus, there's a program called *PageIt* on the disk as well. This can split up documents into odd and even pages, and send both sets to your printer. So you can print out documentation files on both sides of the paper for a change – neat.

WHOM II
PD SOFT V571 AND V572

A two disk release, *Whom II* is a very unusual database. Within it, you can find out statistics on classic series like *Star Trek*, *Time Tunnel*, *The Tomorrow People* and so on, that have been released on video. Basically, it's all the credits from the beginning and end of the shows, typed into an Amiga and arranged so that you can look up facts quickly and easily.

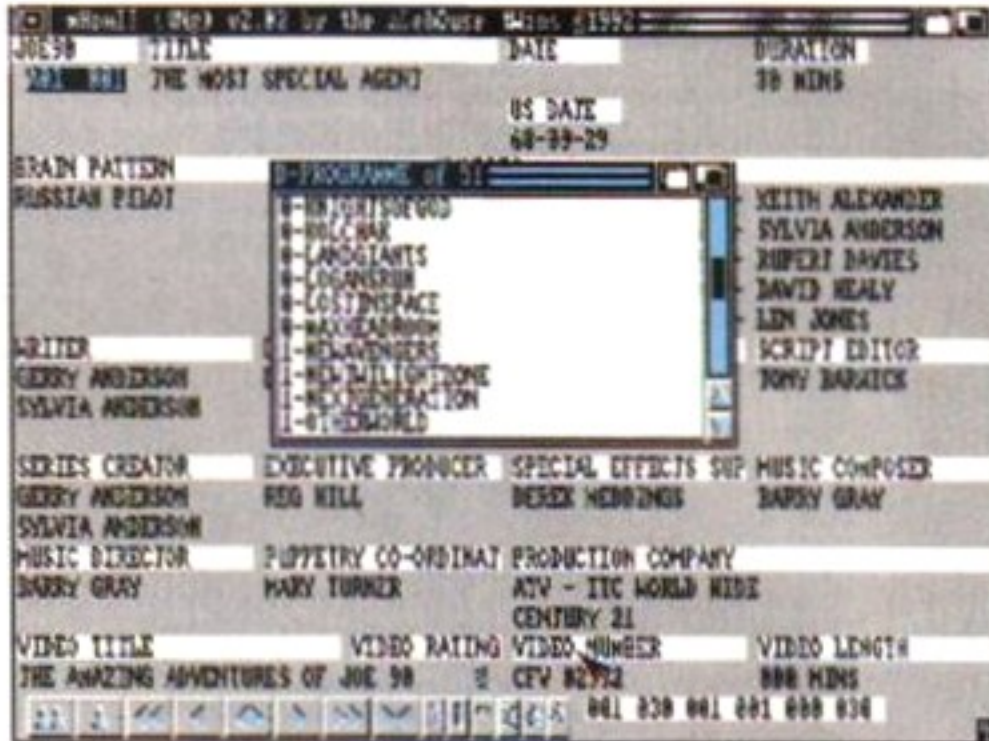

A fanzine database, *Whom II* is not at all useful, but quite intriguing. I mean, can you remember who did the voice for Joe 90?

For instance, although you may know that Joan Collins once starred in an episode of *Star Trek*, you'd probably be hard pressed to remember the name of the episode; "The City on the Edge of Forever". This is sort of statistic that fans devour with relish.

The information is divided into two main areas, the cast and the production crew. So now you can check up to see who the various scriptwriters were. The programmes covered range from *Stingray* to *Red Dwarf* (Gerry Anderson is covered in some depth).

Definitely not mainstream, *Whom II* is well programmed and very user friendly – if you can manage to play a video tape then you can use it. A product of the Alehouse Twins, it will provide many a fan with facts to air at the conference table. It works on an A500 Plus (not perfectly) and single-drive machines too, and separate NTSC/PAL versions are included.

EDITKEYS
17 BIT 1811

There have been programs around for years that can assign strings to the function keys (many PD disks are set up to load programs by pressing a function key) but I've never seen one which could edit a keymap; the file that determines just what is printed on-screen when you press a certain key. If you've ever found that the hash key and the quote symbol have been transposed, that's because the wrong keymap has been selected.

I digress. The documentation is a bit thick and stodgy, but that's down to the subject matter really. Given a few rereads, most of the theory of keymap editing becomes clearer. Up to 32 different characters can be assigned to any key, which should be enough for most people. The presentation of the program is first class, although understanding just what is going on will take time.

Once you have a suitably edited keymap, you can select using the standard Setmap command found on

Continued on Page 162

GAME TAMER 2.3
17 BIT 1765

Ever wanted a list of cheats for every game ever released? OK, *Game Tamer* isn't that good, but it's quite comprehensive. 268 individual cheats are listed – there's even one for *Shadow of the Beast*! Mind you it doesn't work on all the versions of the game. That's a problem with all cheats, in that as a software company reduplicates disks, they often change the cheats over the months and years.

Never mind. There are also level codes for a few games, like *Lemmings* and *More Lemmings*, and all in all it's gratifying to see Gary Henderson is updating his system as time goes on. I've said it before, but the system for using the cheats is really easy to use. Boot up the disk, click on the icon, then on the game you want a cheat for – they're arranged in alphabetical order.

Also on the disk are a couple of other programs. There's a joystick tester, for seeing when your favourite bug blaster has developed a fault. It tests out mice at the same time. And a quite clever version of *MasterMind* called *Wohle*, where you have to guess a colour code within 10 tries. Both are very simple, but they're well presented and executed. Nice one Gary!

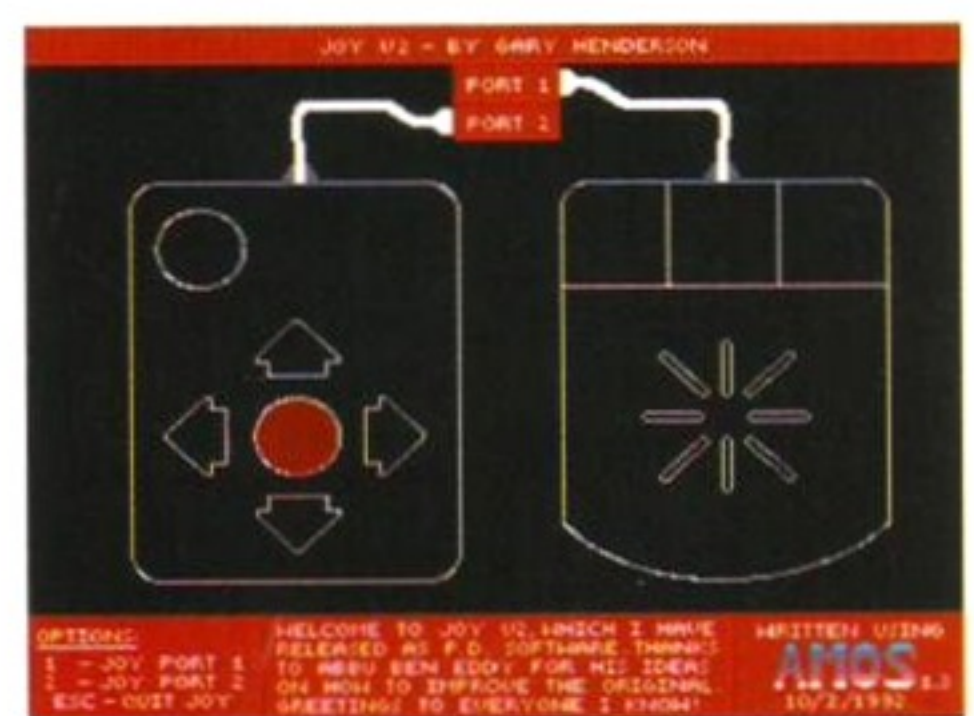

It's very easy to see if your favourite Quickshot XXVXXI Gigablaster is up the spout with a joystick tester. Just waggle it about and if the computer misses one of the directions, one of the switches inside the stick is broken. The mouse test facility is on the right.

Page 7 GME TOWER V2.3 - by Gary Henderson		
Puffin Saga	Raid Blasters	Satan
Quadrillion	Roboed - Part 1	Savage
Raider	Roboed - Part 2	SCI
Railroad Tycoon	Roboed	S.D.I. (Activision)
Rainbow Islands (Part 1)	Roboed 2	Sentinel
Rainbow Islands (Part 2)	Rolland	Shadow Jansen
Rally Cross Challenge	Rolling Home	Shadow of the Beast
Rambo III	Rolling Thunder	Shadow of the Beast II
Return of the Jedi	Rotor	Shadow Warriors
Return to Geonosis	R-Type	Shinobi
Risk Dangerous	Running Man	Silverna
1	2	3
4	5	6
7	8	9
Abort	Greets	Printer : OFF

Yes writing to Gamebusters is not the only way to get the cheats you need to complete the game that's been teasing you all year. Yes with *Game Tamer* it's all very simple to find the cheat for your favourite game – just click on its name and you're there.

vally pd

U/F6, PO BOX 15
PETERLEE, SR8 1NZ
TELEPHONE
091 587 1195

United Public Disc

Games

PG001/2 ADVENTURE SOLUTIONS 2 disks full of adventure solutions! (2)
 PG003 AIR WARRIOR This is a flight simulator program +
 PG004/5 ALL NEW STAR TREK Great game from Tobias Richter! (2) +
 PG006 ANTEP & SLOT CARS A graphical role playing game & a car game +
 PG007 APIDYA Brilliant demo of a great new game. Get it!
 PG008 ASI 1 Tanx, Rollerpede, Avatris, Cavenrunner & Amigoids. +
 PG009 ASI 2 Girl action, Missile command Invaders & 3 more! +
 PG010 ASI 3 Megaball & Drip! Super breakout game & platform game +
 PG011 ASI 4 Jumper, Gomoku, Cracker, Jumpy, Turbo duel & Klondike! +
 PG012 ASI 5 Raid, Go Looly & Retaliator. 3 shoot em ups +
 PG013 ASI 6 Downhill challenge, Pacman 87, Meta Llamas & Wellrix
 PG014 ASI 7 Destination Moonbase, Trux, Mightworks & Clouds runner
 PG015 ASI 8 Air ace II, Hball, Number Bombler & Snakepit! +
 PG016 ASI 9 Battle pong & Blizzard - Two absolute great games!
 PG017 ASI 10 Escape, Pipeline, Pickout & Sys!
 PG018 ASI 11 Dad, Connex, Towers of Hanoi, Reversi & Trippin!
 PG019 ASI 12 Llamatron, Car, Powerpong & X F!
 PG020 ASI 13 Ball Asteroids, Twinnis, Block & Squamble & Amigration
 PG021 ATIC ATAC A conversion of the old classic Spectrum game +
 PG022 AWESOME PREVIEW Fantastic preview of a great game!
 PG023 BATTLEFORCE A strategy war game similar to Mechforce
 PG024 BLACKJACK A really good version of the game!
 PG025 BUCK ROGERS A nifty little shoot'em up from the C-64 days!
 PG026 CASTLE OF DOOM An easy graphic adventure game +
 PG027 CHINESE CHECKERS Computer version of the popular board game +
 PG028 COLOSSUS & WORLD Two very good adventures from Software distillery.
 PG029 CROSSWORD COMPILER Nice program for making crosswords! +
 PG031 DARKSTAFF A spectrum emulated text adventure game +
 PG032 DRAGONS CAVE great Dungeons game, nice graphics! +
 PG034 ETERNAL ROME & DOMINIONS 2 nice games on this disk +
 PG035 ENSIGNIA MAZE Nice little maze game allows 4 views of maze at once
 PG036 FLASHBIER Over 200 levels in this boulderdash type game
 PG046 HACK Great text adventure in the infocom style!
 PG048 HOLY GRAIL A nice text adventure, one of the best +
 PG052 LAMER GAME Similar to operation wolf shoot em up +
 PG053 LARN Another very well regarded text adventure game +
 PG056 LASERZONE Great old 64 classic shoot em up!
 PG057 LEAPING LARRY Simple platform game done in Amos
 PG058 LETTRIX Nice puzzle games similar to Tetris!
 PG059 LORE OF CONQUEST Excellent space trading game D&D style!
 PG060 MARBLE SLIDE Puzzle game, build slides up!
 PG061 MASTER OF THE TOWN Shoot the signposts in this game
 PG062 MENTAL IMAGE PACK 3 great games Gridrunner Invaders & Rebound +
 PG063 MORIA Text adventure based around Dungeons & Dragons theme!
 PG064 NAPOLEONIC WAR SIMULATOR A nice strategy type game!
 PG065 NESTOR CARD GAME Another card game, looks quite good!
 PG066/67 NETHACK Dungeon & Dragon adventure style game, very popular! (2)
 PG068 NO MANS LAND Hi tech war games shoot em up +
 PG069 NU GAME Shoot em up with good graphics, quite difficult!
 PG070 PETERS QUEST Rescue the maiden in this fun platform game +
 PG071 POM POM GUNNER Blast the enemy aircraft in this Beachhead done +
 PG072 PROPERTY MARKET Become a millionaire before you retire at 65
 PG073 RAPHAELS REVENGE A turtles game done in SEUCK!
 PG074 RETURN TO EARTH Elite type space trading game!
 PG076 SEVEN TILES Superb futuresports speedball type game, Great!
 PG078 SCUM HATERS Shoot em up done by Brazzle Atkins in SEUCK +
 PG079 SEALANCE A submarine strategy game seems very involved +
 PG081 SERENE II Follow up to the above game +
 PG085 STARFLEET Nice little game done in SEUCK!
 PG086/87 STAR TREK The US version by Jim Barber, very good (2)
 PG090 SUBCULTURE Playable 1st level of a good shoot em up!
 PG092 SWIV DEMO Superb demo of an excellent shoot em up!
 PG093 TENNIS A good shareware tennis game! 1mg
 PG094 TRAIN CONSTRUCTION KIT make your own track layouts!
 PG095 TREK TRIVIA For you Star Trek freaks, loads of questions!
 PG098 TURRICAN 2 PREVIEW Great demo of superb shoot em up!
 PG100 THE JAR Very nice little jump & run game.
 PG101 THE INSIDERS CLUB Stocks & shares game, see how far you get
 PG102 WATERMINES Nice boulderdash type game!
 PG103 WET BEAVER GAMES Version of the old pong game!
 PG104 WONDERSOFT GAMES Golf, Gong, Missile, Trillon, Windmill etc!
 PG105 WIZZYS QUEST A very good arcade adventure game from Germany +
 PG106 YELP Nice little painter type game!
 PG107 ZEUS A very good & popular block puzzle game +
 PG108 ASSASSINS 14 New Pack, China Challenge II & Amiga Columns!
 PG110 SUPER SKODA CHALLENGE Nice new car racegame!
 PG111 MIDNIGHT THIEF A nice text adventure game!
 PG112 ULTIMATE CARD GAMES Cribbage, Hearts, Blumoon, Patience & Solitaire!
 PG114 CHINA SHOP Great built in china shop game, smash everything in sight!
 PG115/119 NEXT GENERATION TRIVIA 5 disk game with loads of questions! (5)+
 PG121 A500+ GAMES PACK 21 games to run on the A500+
 PG123 LEMMINGOIDS Great game, blast the Asteroids (lemmingoids?)
 PG124 TOTAL WAR great new "Risk" type game, ok on Plus!
 PG125 CARD SHARP 5 tab card games, Klondyke, Demon, Castle etc!
 PG126 SKYFLYER Super WWIII shoot em up, great graphics!
 PG127 AIRMANIA Super platform game from Addware + chance to win prizes!
 PG128 CHEAT WORKS Tremendous amount of cheats on this disk, very good!
 PG129 PUGGLES Brilliant O'Berly style game! Get it While you can!
 PG130 BATTLEMENTS Conversion of the old 8 bit Hunchback game!
 PG131 ATLANTIS A nice looking strategy game!
 PG132 ASSASSINS 15 Battlecars, Mambomove & Lettrix! Great pack!
 PG133 ASSASSINS 16 Wastelands, Mission X, Pacman & Diemanti!
 PG134 ASSASSINS 17 Tomcat, Defenda, Jetman & Bugblaster!
 PG135 ASSASSINS 18 Omegarace, Henry in Panic, Skyfly & Megatron! Super!
 PG136 ASSASSINS 19 Growth, Blobbox, Fight, Bip, Slider & Frantic Freddy!
 PG137 BALL LIGHTNING Pretty average platform game, (not dos 2)
 PG138 BATTLE OF BRITAIN & War Game, 2 strategy war games load on WB!
 PG139 DUNGEONS OF MADROJ Very nice dungeons & dragons type game! load WB.
 PG140 MIND GAMES Lots of mind games to tax your brain with! Load WB.
 PG141/3 SWORD OF THE WARLOCK 3 disk role playing adventure game, 1mg 2drives
 PG144 REVENGE OF THE MUTANT CAMELS Minters all time classic Shootup! Getti!
 PG145 YUM YUM Nice little pacman game for kids, 1 Meg +
 PG146 ASI GAMES 20 Microbes, CornDrop, HollyWood Trivia & MatchPatch!
 PG147 QUADRIX Excellent puzzle style game from Down under, Very good +
 PG148 COSMIC RACER A simple Space Harrier type game done in Amos!
 PG149 A NIGHT AT THE TOWN Witty text based adventure, save the world! (WB)

Business Software

PB001 AMICASH Brand new bank management program, very easy to use. +
 PB002/3 ANALYTICALC Now unpacked and ready to use! (2 disk version) +
 PB004 ASI LABEL PRINTERS 3 of the best label printing programs on 1 disk +
 PB005 BANKIN A complete cheque book analysis program. Keep tabs on cash +
 PB006 BUSINESS CARD MAKER Make your own with this useful utility. +
 PB007 CLERK Another program similar to Journal, manages your bank account.
 PB008 DTP PUBLISHER From Germany, English translation now available +
 PB009 FLEXIBASE DATABASE A simple to use database for the beginner. +
 PB010 JOURNAL A nice program designed to keep track on your finances.
 PB011 MISCELLANEOUS BUSINESS PROGRAMS Geotime, Grocery list, Calc
 PB012 OBASE Database program, simple to use with full search facility.
 PB013 QED A nice easy to use text editor program! Load, save, print. +
 PB014 RIM DATABASE Very comprehensive relational database system.
 PB015 TEXTPLUS V3.00 One of the best wordprocessors, inc. Amigaspell. +
 PB016 UEDIT LATEST RELEASE Word processing shareware program. +
 PB017 VISICALC SPREADSHEET Simple to use spreadsheet program based. +

PB018 WORDWRITE WORDPROCESSOR Comprehensive wordprocessor, speller
 PB019 600 BUSINESS LETTERS contracts, letters, allsorts included!
 PB020 TEXT ENGINE 3.0 New version! Superb quality wordpro. Get it!
 PB021 AMIBASE PROFESSIONAL Now PD !!! Powerful easy to use Database +
 PB022 BBASE II A fast & easy to use database program!
 PB023 FORMS REALLY UNLIMITED Excellent form generation program +
 PB024 LAST WILL & TESTAMENTS Lots of sample Last Wills! +

Utilities

PU002 A-GENE Good genealogy program, to trace your family name. 1meg. +
 PU003 A68K 68000 Assembler program for the Amiga rather difficult to use.
 PU004 A64 EMULATOR NEW VERSION 2.0 of the C-64 emulator BRILLIANT! 2 disks.
 PU005 AMATEUR RADIO 1 Some programs of interest to the radio ham!
 PU006 ANIMATED POINTER PACK Disk full of animated pointers!
 PU010 ARP 1.3 Amigados replacement project, contains new libraries & more!
 PU012 ASI GRAFFIX UTILS Great disk full of graphics converters etc. +
 PU013 ASI BOOT UTILITIES Loads of bootblock utilities on here. +
 PU015 BIORYTHMS, STARCHART Check your Biorhythms & Examine the night +
 PU017/20 C MANUAL II (4) New and better! Version 2 now comes on 4 disks!
 PU021 C-LIGHT RAY TRACER A commercial ray tracing package. Now PD!!!! +
 PU022 CHEMESTHETICS Chemistry program for molecule display etc!
 PU023 CHET SOLACE UTILS 25 utilities on this disk.
 PU036 CURSER BASIC COMPILER Just what you need to speed up basic progr +
 PU037 D-COPY One of the best PD copy utilities available, easy to use. +
 PU038 DARKSTAR UTILITIES 3 A disk full of assorted useful utilities
 PU039 DBW Good PD ray tracing program inc some pictures! CLJ Knowledge.
 PU040 DEMOLISHER UTILITIES 168 easy to use utility something for everyone +
 PU041/43 DESKBENCH Nice alternative workbench, icons + bases (3)
 PU045 DIRECT ACTION A useful utility for editing animation sequences.
 PU046 DISKMASTER 3.0 CLJ Utility program, copy files, delete, format disks.
 PU047 DOPE INTRONMAKER Make your own intro with this utility.
 PU048 DYNAMITE FONT II Another popular disk, Stacks of IFF fontscreens.
 PU049 DYNAMITE FONTS Excellent fonts disk for use in Dpaint etc!
 PU055 ELECTROCAD PREVIEW If you're into circuit design try this now V1.4!
 PU056 EXILE FONTS More of these superb fontscreens. For use with DPaint +
 PU058 FONTS AND RAM MANAGER Lots of fonts plus a software ram switch!
 PU059 FONTS & SURFACES Lots of useful fonts brushes etc for use in Dpaint!
 PU061 GENESIS DEMO Superb fractal generator, really good!
 PU062 GRAPHICS UTILITIES Load of useful graphically orientated programs. +
 PU063 HAMLAB Convert VGA PC pictures to Amiga ham mode with this utility. +
 PU064 HARDDRIVE UTILS Some good utilities for hard drive owners. +
 PU065 ICONMANIA Loads of programs for icon creation & many icons!
 PU066 ICONS This disk is just crammed with useful & varied icons. +
 PU067 IMPLODER V4.0 Very good crunching program, very efficient!
 PU068 INTERFERON PRO Create protection bootblocks against viruses.
 PU069 JAZZBENCH A great alternative workbench much preferred by many!
 PU071 JR COMM 1.02 Latest version of another superb comms package!
 PU072 KEFREN'S METALLION UTILITIES Great util disk full of fonts & more!
 PU073/76 KING JAMES BIBLE Old testament & New testament & text reader (4)+
 PU077 LANGUAGES DISK All you ever needed! Forth, Modula 2, X-Lisp Logo +
 PU078 M-CAD Computer aided design package uses hi res mode. Good. 1M. +
 PU079 MACVIEW_DRAW_ROTATE Collection of three unusual programs.Good!
 PU080 MESSY-SID Easy to use PC - Amiga file transfer program, Brilliant
 PU082 MORBED A very useful program for editing sprites and bobs! +
 PU083 MORSE PROGRAMS Disk full of Morse code programs for radio hams.
 PU084 MYSTIX HARDWARE MODS Documents disk for hardware modifications.
 PU086/7 NORTH C 1.3 (2) A two disk unpacked version of program below!
 PU088 NORTH C 1.3 (Packaged) The complete C compiler by Steve Hawn!
 PU089 PASCAL COMPILER Now becoming a popular language, now PD!
 PU090 PC EMULATOR Software PC emulator needs MS DOS to run! CGA graph +
 PU091 PENDLE MEGUTILITIES 1 An essential collection of over 200!
 PU095 PRINTER DRIVER GENERATOR Design your own printer driver with this +
 PU096 PRINTER DRIVER UTILITIES Various non-standard printer drivers.
 PU097 PRINT STUDIO V1.25 Great utility for accurate printout of pics, text +
 PU101 QUICKBENCH Another alternative workbench system, very clever this!
 PU102 RAZOR 1911 Graphics rippers, Virus killers, Disksalv, powerclever!
 PU108 ROT A simple 3D drawing package for your Amiga. Very popular. +
 PU109 SCOPE 114 Structured clipart for desktop publishing etc! Ppage etc!
 PU110 SCOPE 115 Structured clipart for use in Professional page ETC. +
 PU111 SID V1.6 Newest version of the easy to use CLI utility. Essential!
 PU112/3 SOMETHING FOR NOTHING 2 disk set full of video utils, fonts etc.(2)
 PU114 SOZOBAN C Another very popular C environment, similar to North C
 PU115 ST EMULATOR Run Atari ST software on your Amiga. Needs 2 drives.
 PU116 SUPER C DISK As near to a hard drive as mere mortals get!
 PU117 SUPERKILLERS Kills 233 viruses. This is ESSENTIAL to your collection!
 PU118 SUPER WORKBENCH Yet another alternative workbench disk!
 PU121/2 TV GRAPHICS Superb Dpaint backdrops and some great fonts. (2) +
 PU124 ULTIMATE ICON DISK Contains Iconmaster, Iconlab, Iconmaster & icons +
 PU125 ULTRAPAIN V3 A nice paint package for IFF pictures!
 PU126 UTILITIES COLLECTION Another great collection of utilities about 100!
 PU127 UTILS DISK 1 Another one for the collection. About 60 or more.
 PU128 VECTOR DESIGNER A very comprehensive but difficult to use proggy.
 PU129/30 VIDEO APPLICATIONS (2) Programs for use with genlocks & videos!
 PU132/3 WINDOWSBENCH A Windows 3/Workbench2 lookalike, very nice. (2)
 PU134 WORKBENCH HACKS Disk full of amusing workbench hacks!
 PU136 ZX SPECTRUM EMULATOR Latest version now with sound too!
 PU138 LAST HOPE Priceless when you've just erased a valuable file!
 PU139 GRAPHICS CONVERTERS Convert graphics, format PC disks etc!
 PU140 LITTLEBENCH At last a file copier etc for A500+ (Dos 2 ONLY) +
 PU141/2 TAROT II Learn about your stars with this program, on 2 disks!
 PU143 OPTUTILS 1 Disk crammed with superb utilities!
 PU144 OPTUTILS 2 A second disk full of utilities!
 PU145 OPTICOMMS 1 Contains Nocom 1.921 Lharca, Zoo Arc etc with docs!
 PU147 BEATRIX POTTER Clipart converted from the PC. Lovely. +
 PU149 ELECTRONIC PROTOTYPING Demo version of a "Veroboard" designer!
 PU150 FOOTBALL LEAGUE EDITOR Update league positions of your fav team!
 PU151 BROTHERHOOD UTILS 1 Dcopy, Boot menu, Scenery, Qed (DOS2 ONLY) +
 PU152/66 CLIPART SET: A 15 disk set of all the best available in one set!
 PU167 MULTI-PLOT Excellent data plotting program! latest Version
 PU168a/b RAY-DANCE Brilliant preview of an incredible fractal ray tracer(2)
 PU169 GELIGNITE FONTS Superb cut n paste fonts similar to Exile fonts etc!
 PU170 P-SUITE Make your own disk catalogue with pictures!
 PU171 OPTICOMMS 2 Contains new Nocom v2.0 & other utilities, superb!
 PU172 WORDPOWER Stores anagrams crosswords etc. really useful program!
 PA001 AEGIS ANIMATIONS 3 anims, Juggler, Plane & Marilyn. +
 PA028 AGATRON ANIMS 5 great short looped animations!
 PA029 ANAPLEUC ANIMATION Great anim of an abacus (appleucus??) +
 PA030 BAD BIRD ANIMATION Not too bad this one. +
 PA031 BASKETBALL A basketball player shooting a ball into the net. 1M +
 PA032 BONGO ANIMATION Animation of a man playing the bongo drums. +
 PA033 BUSY BEE Cute animation of a freaky bee, almost looks wooden. 1M +
 PA034 CLOTHES PEG Bouncing clothes pegs and more. Not bad. 1M
 PA035 COOL COUGAR A cartoon style anim, tells the story of cool Cougar. 1M +
 PA036 CX1 SPACESHIP A cool sculpt 4D anim of a ship circling a globe +
 PA037 DART ANIMATION Good animation of a dart passing through an egg!
 PA038 DRAGONS LAIR TIME WARP Animation of the cartoon game. 1M +
 PA039 ERIC-S AMY VS WALKER Cute & sexy(?) squirrel chasing Walker. 1.5M
 PA040 ERIC-S BATMAN A great animation featuring batman and the joker. 1M +
 PA041 ERIC-S COTOTE 2 This ones a conker, coyote up to this tricks 3M
 PA042 ERIC-S COYOTE STRIKES BACK Not too good this time but popular. 1mg
 PA043 ERIC-S MORE AEROTOONS More humorous cartoon capers. Great! 1M +
 PA044 ERIC-S SHUTTLECOCK Two Space Shuttles playing with a satellite. 1M
 PA045 ERIC-S STEALTHY II The Mig-29 and Stealthy bomber cartoon. 1M +

Animations

PA046 FRANKLYN THE FLY Great anim of a day in the life of a housefly! +
 PA047 GHOSTBUSTER ANIMATION Anim on the popular ghostbusters theme.
 PA048 GYMNAST ANIMATION Animation of a gymnast swinging on bars. 1M +
 PA049 HAPPY ANIMATIONS HappyMan, Treefrog, Windowman and Hammer.
 PA053/4 LIGHT CYCLES (2) Huge animation from the Tron film. Fab. 1mg!
 PA055 LUXO TEENAGER Father & son lamp animation, excellent 1M +
 PA056 MAGICIAN II this ones a bit better, more glossier this time round. 1M +
 PA057 MAGICIAN Similar to the juggler anim, but not quite as glossy 1M +
 PA058 MINER A miner truck loading coals into a buggy to be taken away. 1M
 PA059 MR POTATO HEAD Watch the potato man in cabaret!
 PA060 NEWTONS CRADLE ray traced animation, plus F-19 and Rocking chair +
 PA061 PHAROAH ANIMATION An animation of a Pharaoh kings mask. +
 PA062 PIANO ANIMATION This is an animation of a cartoony piano!
 PA064 PROBE SEQUENCE Probe investigates life forms on distant planet 1M +
 PA065/68 REAL 3D (4) Superb demo of effects possible with Real 3D. 1mg!
 PA069 REAL THING HORSES demo of the animation package for deluxe paint. +
 PA070 SHUTTLECOCK ANIMATION 2 shuttles playing with a satellite!
 PA071 THE BOINGS Great anim of 2 Zebudde characters on springs! 1.5M ON +
 PA072 THE JUGGLER The old classic animation that sold 1000s of Amiga's!
 PA073 THE KNIGHT DEMO Animation of a knight climbing out of a book. 1M +
 PA074 THE WALKER DEMO Helicopter attacking the walker. Film style. 1M +
 PA075 THE WALKER DEMO II Walker Attacking the A2000. Not bad. 1M +
 PA077 UNICYCLE ANIMATION Excellent animation of a unicycle & a car!
 PA078 WINGS Superb quality red baron biplane animation. Very nice 1M +
 PA079 MR POTATO HEAD 2 Another great Chris Hill animation disk!
 PA080 LEMMINGS ANIMATION Great lemmings animation. Check it out. 1M
 PA081 BUSTER DOUGLAS Digi anim of Busters not so famous moments!
 PA082 TIN TOY ANIMATION Nice ray traced animation of a tin soldier!

Agatron Animations

AGA01 RED LOTUS Spinning down the road. Fantastic !!
 AGA02 JET FIGHTER landing on a runway, basic anim +
 AGA03 STAR TREK - Shuttle fly past - Great! 1m +
 AGA04 KLINGON CRUISER Flying around your amiga screen!
 AGA05 STAR TREK KLINGON fires torpedoes by 1m +
 AGA06 LOGO, plus a great star wars fly by animation. 1Meg
 AGA07 STAR WARS FIGHTER doing loops etc 1m +
 AGA08 STAR WARS, a great anim from the movie (CLJ, Showanim)
 AGA09 STAR WARS - Fighter fly by, impressive 1m +
 AGA10 STAR TREK - Enterprise in dry dock. Incredible! 1M +
 AGA11 TRON - Tank v Deactivator. Good vectors +
 AGA12 TRON ANIMATION - Not one of the best +
 AGA13 ROBO 1 A nice ray traced robot waving 1m +
 AGA14 STAR TREK Workbee & Reliant. 3 shots +
 AGA15 LOTUS CAR, Billiards, & Jet Fighter animations!
 AGA16 STAR TREK Various anims from the star trek game. Good. +
 AGA17 STAR TREK TWOK animation Short but okay +
 AGA18 STAR TREK - Enterprise fly by, Short anim +
 AGA19 BOND ANIM - Copter plus a car, not too amazing!
 AGA20 Huey 2 A helicopter leaving a landing pad. Neat. 1M +
 AGA21 ENTERPRISE DOCKING WITH SPACE STATION - WICKED !!! 1M +
 AGA22 ENTERPRISE APPROACHING Another stunning anim! 1M +
 AGA23 FLEET MANOEUVRE Stunning animation, shows off your amiga! 1m +
 AGA24 KULI PEN animation & Ping pong. Great! 1m +
 AGA25 THE RUN, a superb car chase 1mg or over. 1m +
 AGA26 SHIP ROCKING at sea, /enterprise leaves dock. 1m +
 AGA27 BOOK OPENING Nice anim of a book opening. 1 Mg
 AGA28 SHUTTLE & ENTERPRISE Fabulous animation by Richter. 1M +
 AGA29 MILLENNIUM FALCON The ship being chased - Excellent 1M
 AGA30 HYPERSPACE animation & Landing animation 1m +
 AGA31 PORSCHIE anim of a rising out of a table 1 mg. +
 AGA32 SPACE - Space probe flying away 1m +
 AGA33 PROBE animation Bird of prey animation & Klingonrht! 1m
 AGA34 SPACE OFFICE - Star trek anim, a little bit short +
 AGA35 SPACE PROBE, great anim of a probe zooming off 1m +
 AGA36 BIRD OF PREY, loop the loop, excellent animation 1m +
 AGA37 TOBIAS GOES KNACKERS - Check this on out! 1m +
 AGA38 TOTALLY WICKED! Shuttle & Enterprise (2 MEG - BUY ONE !!)

Power Animations

PP001/2 ANTI LEMMINGS (2) Absolutely brilliant animation! Get this now! 2M
 PP003 AT THE MOVIES Cute anim from Mr Schwartz featuring Army squirrel 1.5
 PP004/7 AUTOMATED LIGHT (4) Fab battleship galactic type animation. 3ml
 PP008/10 BUZZED (3) Great animation of a wasp crashing into things. 3M
 PP011/12 DATING GAME (2) Superb new demo from Eric Schwartz, Get it. 3.5mg!
 PP013/14 DRAGONS LAIR (2) Three meg power demo with sound effects. Great!
 PP016 GULF WAR ANIM Find out what happens to Hussein! Brilliant! 2mg!
 PP017 JUGGLER II Juggler meets Ms Juggler. Great followup 1.5Meg
 PP018/20 LOST IN SPACE (3) Remember the old TV series? This is it! 2M
 PP021/24 LANDING (4) Tobias Richter Poweranim! Superb ray traced stuff! 4M
 PP025/27 STATION AT KHARN (3) Animation of a space station, nicely done. 2M
 PP028/33 UPGRADE (6) Wow! Cambercock Green meets the Amiga! GREAT! 1.5
 PP034/35 VALUX KILLERS (2) An old but quite good 2mg demo. 2mg.
 PP036/37 WALKER DEMO (2) The 2 disk 2mg version of this classic demo.
 PP038/39 WAVE SAILING (2) A nice animation of a wave sailer! 1.5mg
 PP040/43 AT THE MOVIES II Brilliant, works on 1mg-3mg configurations! (4)+
 PP044/45 AMY V WALKER II Another superb 3mg animation from Eric Schwartz!

Demos

PD001 AGONY DEMO Brilliant graphics in this game demo, show it to ST owners.
 PD005 AMOS 3D DEMO Shows you some effects that are possible with 3d!
 PD007 ANARCHY INSPIRATION IS NONE DEMO with superb ray trace GFX
 PD009 ANARCHY SYSTEM VIOLATION Classy demo Vector Bob Gfx Cool!
 PD010 ANARCHY DIGITAL INNOVATION Their latest and best! superb!
 PD011 ANIMATORS MEGADEMO A nice new megademo from the Animators.
 PD016 BUBBRAIN II Hilarious megademo, music, music video & more
 PD018 CHAOS ROCK A fantastic light show based on fractal patterns. +
 PD020 CRONICS MEGADEMO Includes the superb madonna demo and more!
 PD021 CRONICS NEVERWHERE Superb! with a Real world demo & Madonna
 PD022 CRONICS TOTAL DESTRUCTION Very nice plasma plus kickin music!
 PD023/25 ALCATRAZ MEGADEMO Excellent, huge demo on 3 disks! + (3)
 PD026 CRUSADERS SPACE DELIRIA Fantastic music by Dr. Awesome!
 PD027 CRYPTOBURNERS HUNT FOR RED OCTOBER Lovely filled vector demo.
 PD030 DEAD DANCE THRASH Amazing thrash metal soundtrack & wierd pics!
 PD032 DEVILS LABYRINTH Great new demo with some fab effects, RGB plasma
 PD033 DEVILS NO REALITY Another great multipart demo from Devils!
 PD036 E-P+C Incredible preview to a new game by Ocean, vectors. 1M
 PD037/38 ERPLAND (2) Brill kalidescope patterns on this great demo!
 PD039 FILLET THE FISH Similar to puggs, but not quite as good. +
 PD041 FRAXION FUTURE VISIONS Superb Aliens-type intro plus pictures -high
 PD044 HORIZEN SLEEPING BAG Great multipart demo with vectors, music.
 PD046 IRAQ DEMO Amusing demo of Saddam meeting President Bush!!!
 PD049/50 KEFREN'S MEGADEMO VIII Loads of filled vectors and music.(2)
 PD051/52 KGB MEGADEMO (2) A great house music video & vector drummer
 PD055 MAGNETIC FIELDS HYSTERESIS Excellent vector graphics!
 PD056/57 MAGNETIC FIELDS SPACED OUT (2) demo with great music tracks
 PD058/59 MAXIMUM OVERDRIVE (2) Very nice filled vector demo by TSB.
 PD064 NEWTEK DEMO 3 excellent demo, take your machine to the limit!(2)+
 PD066 PHENOMENA ECES A very good demo with light sourced vectors!
 PD067 PHENOMENA INTERSPACE Is lime Linear? Get this to find out!
 PD068 PHENOMENA ENIGMA Absolutely brilliant, one of the greatest +
 PD069 PHENOMENA JOYRIDE Another absolute corker of a demo!
 PD076 PLASMUTEX Kickin Soul/Soul music beats & wild copper plasma!

nbs

U/F6 1 CHAIN LANE NEWPORT
ISLE OF WIGHT PO30 5QA
TELEPHONE
0983 529 594

- Mail orders: Send your Name, Address & order details with and enclose a cheque/Po/Imo.
- Telephone orders: Call us now, and we will have your order sent out to you fast!
- Prices: 1 - 19 PD disks - £1.25 each • 20 or over - 99p each • Deja Vu licenseware is £3.50
- Postage: UK add 50p 1st class postage & packing, for Recorded Delivery add £1.00
- We love International orders - Air mail to Europe +25p per disk • Rest of World +50p per disk

main Distributors

start
 U/F6 • 20 HOLMESIDE
 SUNDERLAND • SR1 3JE
 TELEPHONE
091 565 2506

PD077 PMC ALPHA OMEGA An absolutely superb filled vector demo. +
 PD078 PUGGS IN SPACE A classic demo, the kids will love it.
 PD079 PRISONER DEMO Remember the old 60s series? Here's the demo!
 PD085 REBELS MEGADEMO II An old classic blast from the past!
 PD088 REBELS SNAP A nice demo with spooky style music track. Great
 PD090 REBELS TRIPLE TROUBLE Some brilliant plasma effects here!
 PD090/91 RED SECTOR MEGADEMO (2) Still stood the test of time, good +
 PD093 SCOPEX CHROMIUM Superb demo with great graphics and music +
 PD094 SCOPEX MENTAL HANGOVER One of the best demos of all time. +
 PD097 SILENTS GLOBAL TRASH This is a MUST for all demo freaks +
 PD098 SILENTS ICE Latest demo from the Silents. Brilliant music +
 PD106 TECHNOFRIGHT A spooky demo with good music & effects!
 PD108 TOMSOFT TRIP TO MARS Very good 3D filled vector trip to mars
 PD109 TOMSOFT VIRTUAL WORLDS An absolute Epic! Best demo of the year
 PD111 UNREAL DEMO Superb graphics & sound in this great demo. +
 PD113 VANGELIS DEMO Great music & superb colour cycled gfx. 1mg. +
 PD114 VECTRA SINKING DEMAND Really good filled vector demo.
 PD116 WITH VECTORS TO HEAVEN New demo just in, check it out!
 PD119 REBELS OUTLAND Latest demo from a prolific outfit! Excellent
 PD120 KEFRENS GUARDIAN DRAGON A very nice new demo from KeFREns!
 PD121 DIVINA TECHNO FRIGHT Vectors in front of Ham pics? Good!
 PD123 ITALIAN BAD BOYS MANGAD Japanese style cartoons & techno music!
 PD124 ANDROMEDA DECAYING PARADISE Very good vector demo & music!
 PD125 RAY OF HOPE 2 Great megademo, good music & graphics!
 PD128 LEROY 1 Great pack inc. Substance, Shining vector, & more!
 PD127 BASS SUBLIMINAL VISION Very heavy rave music & graphics!
 PD128 DIVINE INSPIRATION New music disk by Goldfire. Very good.
 PD129 RAZOR 1911 VOYAGE Another great party winner demo Super effects!
 PD130/34 ALCATRAZ ODESSY Awesome 5 disk space extravaganza! Brill! (5)
 PD135/6 CRIONICS HARDWIRED Fab space anim with superb effects & music (2)
 PD137 ANGELS EVOLUTION DEMO Great psychedelic vectors & more!
 PD138 ANARCHY SEEING IS BELIEVING Brilliant demo with excellent music!
 PD139 TRACKERS POWER & AGONY DEMO Some unusual Vector effects!
 PD140 CELSIUS 23 MORE VECTORS A Terminator intro + hundreds of vectors!
 PD141 WILDFIRE MEGADEMO great House & dance music on this megademo!

PS088 EVOLUTION SLIDE Pics from one celled life to humanity?? +
 PS090 FRACTALGEN Great fractal landscapes & star studded skies+ music!
 PS091/2 FRACTAL MOUNTAINS Superb 2 disk set of fractal pictures!
 PS093 VANISH 3D Awesome 3d ray traced picture disk!

Music Utilities

PT001 ALGORYTHMS Midi program for synthetic music creation.
 PT002 ART OF MED Disk full of Med music scores. +
 PT003 ASI AUDIO MAGIC Collection of soundtrackers and ripping progs!
 PT004 ASI AUDIO MAGIC 2 Latest collection of soundtracker programs!
 PT005 CASIO CZ EDITOR Superb program + 250 patches for Casio CZ series. +
 PT006 DELUXE MUSIC DATA Some scores need midi synths (Deluxe music)
 PT007 FUTURE COMPOSER A chip music sequencer. Complex to use, but good
 PT008 GAMES MUSIC CREATOR A music sequencer. Similar to soundtracker.
 PT009 JFF SAMPLES Great samples taken from the Kawai 1 digital synth!
 PT010 JAMCRACKER Four channel chip music sequencer. Handles samples
 PT013 MED 3.2 Very latest version of this superb sequencer. Great!
 PT014 MED MUSIC DISK Some nice med music on this disk +
 PT015 MIDI TRACK Contains lots of useful midi programs for synth owners +
 PT016 NOISE DISK Music sequencer used by the pros. Stacks of functions
 PT017 NOISETRACKER-EXECUTABLE Convert modules to executables
 PT018 PERFECTSOUND SAMPLER Nice sample edit program with samples!
 PT019 ROLAND D110 + S220 Converter program, convert Roland samples to IFF.
 PT020 SAMPLES DISKS ST-01 TO ST-10 Various disks available, ring for details.
 PT021 SOUNDTRACKER 2.6 New release of this popular program, new editor!
 PT022 SOUNDTRACKER A superb four channel sequencer. Easy to use
 PT023 SOUNDTRACKER COMPILATION Compilation of tracker type programs
 PT024 ST-80 BEAST SAMPLES Lovely pan flute sounds from Beast. Beast II
 PT025/6/7/8 ST-90-93 SAMPLES DISKS Studio quality samples. Excellent!!! +
 PT029 YAMAHA DX7 VOICE FILER Program for the DX7 series synthesisers
 PT030 YAMAHA DX7 VOICE SORTER For the above program.
 PT031/2/3 ST-97 - 99 3 disk full of great samples!
 PT034/5 ST-97 & 98 2 more great disks full of samples!
 PT036 SAMPLE MAKER Allows you to create samples without a sampler!
 PT037 PROTRACKER 2.0 New version of well known music program!
 PT038 YAMAHA DX100.TX81Z, DX27.DX11 & FB01 editors & librarian!

PUBLIC DOMAIN DISKS ONLY ...

99p

PER DISK!

THIS OFFER ONLY APPLIES WHEN YOU BUY 20 OR MORE DISKS!

LPD45 + MUSIC BOX A music program for children of 7 upwards.
 LPD47 + DIRTY CASH Our most popular game! Fruit machine simulator
 LPD49 + MARVIN THE MARTIAN Find your girlfriend in this maze game
 LPD51 + MAGICAL YOUNG ARTIST Contains 30 stencils to colour in!
 LPD52 + LC24-200 FONTS Installs fonts for Star series printers!
 LPD55 + SPRITEX V1.32 New sprite editor, superior to original editor!
 LPD56 + CTEXT V1.23 and 1.3 for programmers, use icon bank based fonts!
 LPD57 + KIDDIES CLIPART Another nice clipart disk!
 LPD58 + LOCKS KEYS & ENEMIES Hunchback game! Brilliant, just get it!
 LPD59 + THE PREHISTORIC FUN PACK Four dinosaur games for kids
 LPD60 + TECHNO SNAIL Fire slime at the enemies - Great platform fun!
 LPD61 + THE FINAL CHAPTER 3D graphics adventure. Very good!
 LPD62 + REVOLUTION Four player game get to the top of the Screen 1st!
 LPD63 + WILBERTS WINTER WONDERLAND Excellent platform game - Get it!
 LPD64 + RESCUE II Totally wicked 3D vector game - GET IT!!!!
 LPD65 + POWER PLANNER Personal organiser - Keep track of your life!
 LPD66 + HOTEL MANAGER Similar to monopoly - Brilliant!!!!
 LPD67 + CYADONIA (CYAD II) Boulderdash clone - collect the diamonds
 LPD68 + VIRUS BUSTER Very good new virus killer disk, needs 2 drives!
 LPD69 + MAGICAL MIX UP Puzzle game, sort out the mixed up pictures!
 LPD70 + PAINTBOX Childrens painting package to color in or draw
 LPD71 + BATTLECARS Car racing game for two players, really addictive!!!
 LPD72 + MONSTER ISLAND Brilliant role playing game for kids.
 LPD73 + AMOS DATABASE V3.0! Simple & easy to use with lots of functions
 LPD74 + SOUR GRAPES 3D isometric game. You must get your enemy drunk!
 LPD75 + VIDEO LAB Simple to use titling package for home videos! (2 drives)
 LPD76 + T-TECMAZE Excellent puzzle type game switch games on/off!
 LPD77 + SPECTRA 2.1 Powerful database system with a host of features.
 LPD78 + CHEATLISTER Logic puzzle game & a host of cheats
 LPD79 + MUSIC ENGINE Play MED-ST-NT modules without converting them
 LPD80 + ICON BANK EDITOR Manipulate icons in the same way as sprites
 LPD81 + POOLS PRO Program to help you fill in your pool coupons
 LPD82 + COLORING BOOK 2 8 More pictures to color in this Hangman game.
 LPD83 + PICTURE HANGMAN Excellent variation on this Hangman game.
 LPD84 + GUESS WHO Another Hangman type game. Good.
 LPD85 + MAGIC WASSOCKS A great little arcade game worth seeing.
 LPD86 + NCOMMAND V2.038 Give your workbench the 2.0 look!

Music Disks

PM001 100 GREATEST 64 TUNES Over 100 classic 64 tunes immortalised!
 PM004 ALCATRAZ THE POWER Excellent re-mix of the song by Snap.
 PM005 ALCATRAZ MORE THAN MUSIC A superb music disk well presented.
 PM007/8/9 AMAZING TUNES II (3) This ones a biggy loads of great music!
 PM010 AMEGA PARTY WINNERS Four EXCELLENT songs that won the party +
 PM012 AMAGICAL CLASSICAL Superb renditions of Eine Kleiner etc. +
 PM013 ANARCHY CAPTURED IMAGINATION Excellent music by 4-Mat +
 PM014 BANGING RAVES Yeah! Pump up the music, kickin remix of house
 PM015 BEAST SONIX Scoopes present the music from Beast I, all tunes. +
 PM016 BEATLES SONIX Lots of Beatles music done in Sonix!
 PM017 BEATMASTER 808 STATE Cubik and more of this type of music.
 PM018 BEATMASTER I LOVE TECHNOLOGY More of the rave type music. +
 PM019 BRUNO'S MUSICBOX II This is great Jazz-Funk music!
 PM020/21 BRUNO'S MUSIC BOX III More jazzfunk style music. Get it!
 PM022/23 CLASSICAL MUSIC Great music of Bach, Handel etc from Rob Baxter. +
 PM030 DIGITAL CONCERT 2 Thirteen minutes of music, Doctor in the house
 PM031 DIGITAL CONCERT 3 Another house music re-mix Great quality - Love it
 PM032 DIGITAL CONCERT 4 Four songs including Got to keep on - Brilliant!!! +
 PM033 DIGITAL CONCERT 5 The Power, Kees, Keep Bustin Touch Me. Brill!
 PM034 DIGITAL CONCERT 6 Latest in the series, very good quality House music
 PM035/36 DIGITAL DEBUSSY Excellent! Clair de lune & more tracks +
 PM041 EQUAMANIA II Demo with a great dance music track and fab equalizers!
 PM042/43 EVIL FORCES Brand new mega acid/house demo (sweating!!)(2) +
 PM047/48 GOLDFIRE CEREBRAL DELIGHTS!! Excellent music disk. +
 PM052 KEFRENS JUKEBOX This ones super! Lovely music with a Juke box!
 PM058 MAGNETIC FIELDS CHIP FESTIVAL Crammed full of great chip music!
 PM059 MANIACS OF NOISE This is brilliant! Great stieve wonder type music!
 PM065 PHENOMENA MUSIC DREAMS 120 wicked songs by twins +
 PM066 PHENOMENA MUSIC DREAMS II Second in the series More music!
 PM067 POPEYE MEETS THE BEACHBOYS Great demo very funny!
 PM069 RAZOR FACE ANOTHER DAY This is an incredible music track!!
 PM070 RHAPSODY IN BLUE Great conversion of Gershwin by Rob Baxter! 1M
 PM071/72 SILENTS BLUES HOUSE (2) Tangerine Dream style music & game!
 PM073 SILENTS FULL POWER House it up music, Inc Remix of tricky disco. +
 PM074 SOUND OF SILENTS This is a must! Great atmospheric music!
 PM078 TECHNOTRONIX REMIXES Pump Up the Jam and Get Up!
 PM079 TECHNOTRONIX REMIX The songs remixed into one great track!
 PM080 THE SOUNDS OF GNOME Mahoney and Kaktus music. 46 great tunes.
 PM082a/82b VIVALDI - FOUR SEASONS (2) Superb 4 Seasons by Mr Baxter!
 PM087/88 HIS MASTERS VOICE Even better than the sounds of gnome! (2)
 PM090/91 MOZART HORN CONCERTO'S 4 superb concerto's from H.Gannon +
 PM092 PIANO TUNES 9 Great Protrackered tracks from Andy Chilton!
 PM093 UTAH SAINTS REMIX What can you do for me remixed by Tony Hilton!
 PM095 HARDCORE III Brilliant techno dance tracks.
 PM096 STAIRWAY TO HEAVEN & Send in the clowns & other tracks. Great!
 PM098 ERASURE MIX Remix of erasures top songs.
 PM100/103 MANIC RAVES II Fantastic 4 disk music set with Simpsons anim! +
 PM104 500 THINGS COMEBACK 4 great rave type tracks, very well done!
 PM105/6 KEFRENS MEGAMIX (2) Fabulous dance music, Amazing quality +
 PM112 TECHOMANIA II Eight essential hardcore tunes for ravers out there +
 PM113 PROTON GATES OF TIME 6 nice pieces of music on this disk!
 PM114 CHROME SPLIT BEAVER MIX Excellent dance music mix. +
 PM115 CHROME SHOW OFFER your amix sound with this incredible music set (2)+

Amos Public Domain

APD036 + AMOS 1.34 UPATE Latest edition of the updater!
 APD062 + ARCADIA A nice version of the popular breakout game
 APD076 + RAINBOW WARRIOR Paint with coppers and save them out!
 APD083 + AMOS PAINT V3.7 Nice paint package in 2-64 colours.
 APD085 + REVERSI - SNAKES & LADDERS 2 well known games
 APD096 + PAIR IT Match the cards to make a pair, easy to play 1mb
 APD103/4 + PICK UP A PUZZLE Solve jigsaw puzzles, 3 difficulty levels
 APD110 + CROSSFIRE Nice game, keep the kids occupied for ages.
 APD115 + BALLOONACY Good version of the classic Bomber game.
 APD130 + THE WOODEN BALL A shareware game 1mb
 APD132 + FAMILY HISTORY DATABASE Nice geneology program 1mb
 APD137 + TILE TRIAL Sliding tile puzzle to solve within a time limit
 APD148 + DEMOLITION MISSION Another version of popular bomber game. 1mb
 APD176 + DATABASE MASTER V2.0 Nice database program, needs 1mb
 APD180/1 + DUNGEON DELVER Room round mazes collect keys etc (2 disks)
 APD182/3 + PIXIE KINGDOM Another good exploration game on 2 disks
 APD229 + AMOS MULTIPAIN Another Amos paint program!
 APD230 + AMOS ASTEROIDS Four versions of the asteroids game.
 APD231 + AMOK Your robot is trapped in a strange world 1mg
 APD237 + SHAPES Very nice little puzzle game.
 APD257 + CASSETTE LABELLER & MIXED SOURCE Make your own cassette s
 APD271 + WIZARDS DOMAIN Nicely done graphical adventure game
 APD284 + AMOSAGRAM Nice anagram program.
 APD292 + WAR OF THE FOUR A shareware graphic adventure game
 APD293 + GRAND PRIX SIMULATOR Not a race game, more of a simulation.
 APD314 + BLACKJACK TRAINER A nice new blackjack game!
 APD318 + BOING Get Herbert back home to his village!
 APD325 + HANGMAN V2 Hangman game with editor!
 APD326 + HYPERBALL Latest version of woodenball, an excellent game!
 APD329 + FRUIT MACHINE Quite a nice little fruit machine program!
 APD333 + AMERICAN FOOTBALL RADIO VERSION You are a football coach!
 APD334 + SNAKE IN THE GRASS Collect white mushrooms, avoid toadstools!
 APD340 + KARATE WORM Very nice platform game, jumping over worms etc!
 APD343 + SAVE THE TREES Stop the baddies destroying the trees!
 APD347 + NOTEBOOK Easy to use notebook & shopping list program!
 APD351 + ARCHIVIST 2.0 Demo version of a useful database program!
 APD356 + POWERBASE V2.0 Demo version of a very powerful database!
 APD362 + SQUAT THE REVENGE Operation wall type game!
 APD363 + CHAIN REACTION & CPU CHALLENGE 2 games
 APD367 + WEIRD IN EDGWAYS Circuit board based puzzle game!
 APD373 + COMPILER 1.34 UPDATE Update for the Amos compiler!

Deja Vu Licenseware

LPD01 + COLOURING BOOK Colour in the nursery rhyme pictures
 LPD02 + ARC ANGEL MATHS An educational game to help kids with maths
 LPD03 + GALLEONS Follow up to the popular dogfight II game.
 LPD04 + THINGAMAJIG Superb jigsaw style game for kids, easy to use
 LPD05 + JUNGLE BUNGLER Icon driven adventure game for the kids
 LPD06 + PUKADA & SPRITES Avoid all the baddies as you remove the tiles
 LPD07 - FOUR WAY LYNX A 22 level puzzle to tiles to a main center tile
 LPD08 + WORK & PLAY 3 really good educational games on this disk
 LPD10 + THE WORD FACTORY Great program helps the kids to spell
 LPD11 + GO-GETTER A card game where you have to pass go.
 LPD12 + HYPNOTIC LANDS catch balls coming down four different lanes
 LPD13 + JIGMANIA A jigsaw solving puzzle & a jigsaw construction kit
 LPD14 + PLAY IT SAFE For the very young, helps to teach safety at home
 LPD15 + ARC ANGEL SHAPES Make pictures from a variety of shapes
 LPD16 + REVERSI II New improved version of Reversi!
 LPD17 + DOGFIGHT II An 8 player shootemup game. Great!
 LPD18 + TOUCHSTONES An Ishido type game played with tiles
 LPD19 + X-IT-50 Shoot objects across the screen
 LPD20 - WORDY A basic Amosware wordprocessor program, quite good
 LPD21 - QUINDO Great quiz game in which you play Bingo
 LPD22 - LC10 FONTS New fonts for your Star LC10 / LC200 printer
 LPD23 - ESP FONTTS The letters ESP
 LPD25 - THE MISSION A great text adventure written in Hisoft basic
 LPD26 - CYAD Collect the diamonds in this puzzle game
 LPD27 - FLOWER POWER grow flowers before bugs munch them away.
 LPD28 - BUDDBASE Simple to use database with tutorial
 LPD29 - BIG TOP FUN 4 great educational games for younger children
 LPD30 - SHYMER Nursery rhyme adventure game for young or old.
 LPD31 - CLI PRINTER DUMP Prints a screen dump of the screen display
 LPD32 - HARD DRIVE MENU SYSTEM Has menu of over 3,800 items.
 LPD33 - CREATIVE ADVENTURE TOOLKIT Produce stand alone adventures
 LPD34 - INVOICE PRINTER Quick production of invoices on paper
 LPD35 - T-TECDRAW Technical drawing program with print facilities
 LPD36 - FRACGEN II Great fractal program generator
 LPD37 - ROCKET MATHS Help children in maths with this game
 LPD38 - AMOS ART Contains lots of fonts, bobs, sprites & scenery blocks
 LPD39 - MAGIC FOREST II Great sideways scrolling platform game
 LPD40 - SPRITE BANK EDITOR Makes sprites really easy to use
 LPD41 - RESCUE A 3D adventure game done with 3D construction set
 LPD42 - X-STITCH Print out pics for embroidery, with documents
 LPD43 - LAZERZONE Shoot the aliens in this addictive shootemup
 LPD44 - FORMULA ONE CHALLENGE Strategy road racing game. VGood

Educational Software

PE01/5 EDUCATION SET Science, Geography & more. Superb! (11+) (5) +
 PE006 KIDSPAIN Superb talking colouring book for the very young!
 PE007/8 LEARN & PLAY 2 disks of educational programs, under 10s +
 PE009 STORYLAND 2 Brilliant kids game, save toyland from the witch!
 PE010 TOTAL CONCEPTS ASTRONOMY Fab interactive book on a disk. Get it!
 PE011 TOTAL CONCEPTS DINOSAURS Learn about the dinosaurs. fantastic!
 PE013 SIMON & SPACE MATHS Talking maths program for kids +
 PE014 SPANISH, FRENCH, GERMAN TUTOR Translates all languages +
 PE015 TREASURE SEARCH Help the pirate find that treasure!
 For more excellent educational software see the Deja Vu listing, above

NEW LICENCEWARE

● **OBLITERATION** The Ultimate ShootEmUp, A cross between Turrican & asteroids, has received more rave reviews than I've had Chicken Nuggets. Utterly addictive - You'll love it! Cost £3.50

● **WILLIES WATER WORKS** Put the pieces together to let the water flow through the pipes, an excellent puzzle game for all ages. Cost £3.50

● **FISH LISTER** A superb program that contains a catalogue of every single fish disk fully indexed on Name & category. An essential program for the serious amiga user. Cost £3.50

● **VIDEO TITLES** Easy to use titling package for video users, uses any amiga workbench font, with full load & save - Excellent + Cost £3.50

● **TOTAL CONCEPTS DINOSAURS** This is the first in a new series, Total concepts is an interactive encyclopedia that lets you explore the world with pictures and information on a profusion of subjects. This title is based on the ancient world of the Dinosaur. Plus Compatible. Supplied on 2 Disks, Cost £4.50

Slideshows

PS002 ADVANCE HAM A collection of brilliant digitised pictures with music +
 PS003 AGATRON 5 Some superb HAM pictures, created by Tobias Richter. +
 PS004 AGATRON 6 Incredible 4096 color ray traced S/S. Get this one!
 PS005 AGATRON 8 Excellent HAM pictures, with some good music too. Mega!
 PS006 AGATRON 9 More of Richters superb works, again based on Star trek.
 PS007 AGATRON 12 Some more great pictures on this new disk. +
 PS008 AIRCRAFT SLIDE Lots of pictures of fighter aircraft. +
 PS009 ASTRONOMY SLIDE Nice pics of constellations, galaxies nebulae etc!
 PS013 BORN TO BE FREE Picture of wild animals this time. Very good quality!
 PS014/15 BUTTERFLIES (2) High quality slideshow of butterflies, by WS +
 PS016 C64 ART Lots of picture screens from the good old Commodore 64.
 PS017 CHAINSAW SLIPPERS This one is great, the pictures are naff but Mad!
 PS019 COLOURCYCLES A slide of colour cycled pictures. Very impressive. +
 PS023 DEMONS III A quality S/S from C-Dryk of Demons, with music
 PS025/26 DIVINE VISIONS (2) A S/S of Mythological gods with music +
 PS030 FRAXION FUTURE VISION Great fantasy S/S, fab for lo res. +
 PS032 GENOCIDE great fantasy slide with unusual fades & wipes & soundtrack.
 PS033 GERMAN RAY TRACE High quality ray traced pics by a german artist. +
 PS045 KELLY S/S Some excellent quality HAM pictures.
 PS052 NAGEL PICTURES Hires pictures of girls, very arty. +
 PS056 NEWTEK DYNAMIC HAM A S/S of Newteks new 640x512 4096 colors +
 PS057 NEXT PIXELIUM Very nice pictures all done in Dpaint plus some music.
 PS062 NW DYNAMIC HAM More from the Nik Williams series. Superb quality. +
 PS063 PENTAGON & DRIFTERS Very high quality Hi-res B/W fantasy pictures.
 PS064 PHOTOMONTAGE I S/S on various subjects very nicely done. +
 PS065 PHOTOMONTAGE II Another great slide of various subjects. +
 PS067 RICK PARK'S ART Dpaint style pictures all done in Hi Resolution. +
 PS069/70 SILENTS/CH 42 (2) This is superb, slides plus a great music track.
 PS072 SUPER HAM CARS Superbly digitised S/S in Interlaced HAM. Mega!
 PS082/83 WRESTLE MANIA (2) Collection of picture and animations. Good!
 PS084 WWF WRESTLERS Pictures of Hulk Hogan and the rest of 'Em. Great!
 PS086 SONIC DYNAMIC HIRE S 5 Superb 4096 colour pics on this disk!
 PS087 ALTERED DECEPTIONS Superb disk of pictures from Chris Hill!



● All disks with the + sign are compatible with the new A500 Plus & A1500 Plus
 ● We also stock other libraries including Fish 1 - 630, T-Bag, Amigos, and more!
 ● If you dont see the disk you want here - Just give us a call!



ALL MAJOR CREDIT AND DEBIT CARDS ACCEPTED



blitterchips

U/F6, CLIFFER HOUSE
 PRIMROSE ST, KEIGHLEY
 B D 2 1 4 N B
0535 667469

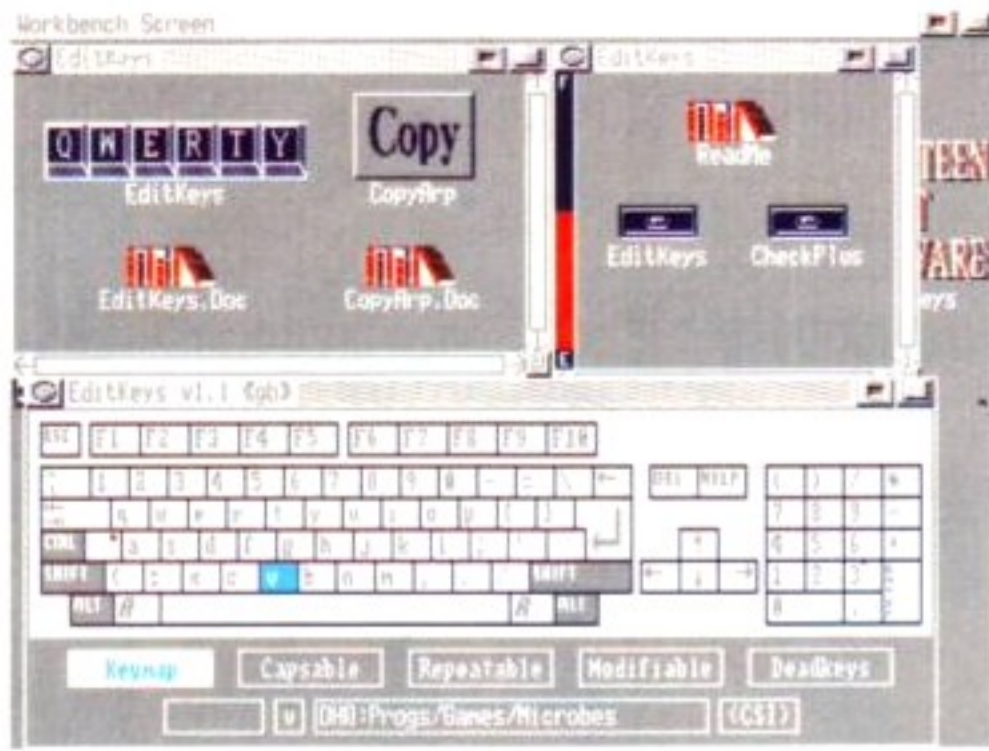

A very clean frontend gives edit keys a basic strength. Just select the key you want to edit with the mouse, type in the character or string of characters that you want to be printed with that key, and Robert is indeed your uncle.

every Workbench disk. Also included on the disk is a handy program for startup-sequences and similar script files, called Checkplus. This returns one value if the machine it's running on has Kickstart 2, and a different value for older versions. The whole lot works on an A500 Plus – congrats to David Kinder on producing one of the more useful disks I've seen this month.

ABSOLUTE ADVENTURER VOL 1
17 BIT 1774

If you want 12 different maps for *Black Crypt*, hints for *Elvira II* and *Leisure Suit Larry V*, *Space Quest IV* and *Fascination*, a complete solution and cheats for *Ultima VI* and all the levels of *Power Monger*, get this. Otherwise don't bother. Slick presentation, but not by LSD's standards.

EDWORD 2.2
17 BIT 1776



Want a cheap text editor that runs well under interlace? Sorry we can't reproduce the screen flicker, but if you have a multisync or SVGA monitor then the display will be this good.

EdWord does not really offer much more than other PD offerings like *TextPlus 3.0EN* or *TextEngine 3*, but it certainly is user friendly. You can do all the normal things, like cut-and-paste blocks of text where you want, set markers and jump to them, or go to any line.

However, *EdWord* was designed with the programmer in mind, and does have a couple of tricks up its sleeve. It can run script files by selecting a menu option (handy for running a separate compiler or assembler) and can also be taught program commands or key words, and force them into upper case. Handy for finding typing errors that cause bugs in programs. You can also run the program in interlace if you're lucky enough to own a multisync monitor and a flicker fixer (or an SVGA monitor and the Enhanced Chip Set found in the A500 Plus).

EdWord took over two years for the author, Martin Reddy, to write. If you've already a text editor there's little here that's new, but like I say for the programmer bashing out source code it's quite ideal.

PRO TRACKER 2
17 BIT 1750

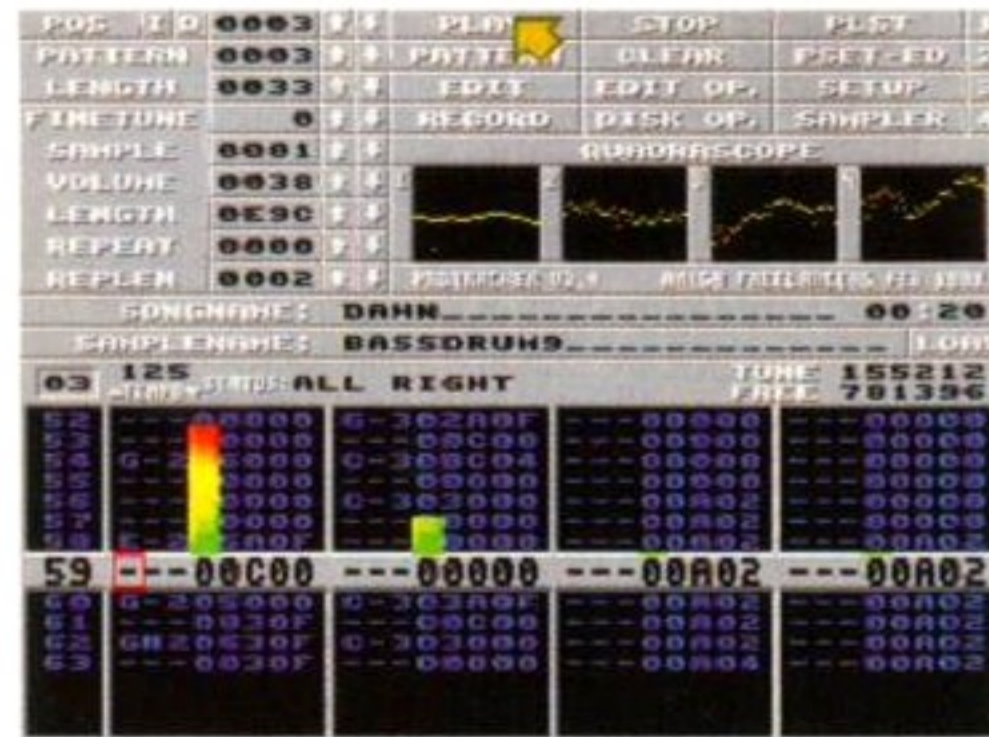

The main updates in *ProTracker 2* seem to be in the sample editing department, although the inclusion of a large readme file is very welcome.

I've heard quite a lot about the latest incarnation of *Tracker*. *NoiseTracker*, *SoundTracker* and *ProTracker* have much the same 'look and feel' to them. They are used to arrange sound samples together, forming blocks of music, which can be further arranged to form songs, albeit ones without much in the way of vocals – but then getting the Amiga to sing would be a tall order, nearly as tall as making it dance.

This version has a much slicker feel to it than others I've seen. Lars Hamre has done a good job in modifying the front control panel. In terms of capability, all the old options are there – it can still be used to read in samples through a sampler cartridge plugged into the parallel port, making the process of composition that little bit less tiresome. More options have been added, giving you more control over what the sounds come out like, and you can now boost or filter them to just the right level.

Also, *ProTracker 2* can make use of synth sounds, which are very small in size (pure sound samples tend to be large) but lack the harmonics of real sound. All the same, if you can squeeze a couple of extra sounds into a song, so much the better.

It's heartening to think that programmers are still prepared to extend and strengthen the *Tracker* saga, even though for musician and musical novices (like myself) it's a bit of a nightmare. *Tracker* programs are mainly used by musicians producing songs to include in other programs, like games and PD demos. Best of all though, there's a hefty documentation file (50K) to help you get acquainted with the program.

OPTICOMMS 2
VALLY PD PU171

Good heavens, just when I was despairing of ever seeing an update to the highly popular *NComm* program, version 2 shows up. This hasn't been done by Daniel Bloch, who was responsible for *NComm 1.9*. Instead, Torkel Lodberg of Oslo has spent months developing what has to be the best comms program yet.

A word of explanation: comms. Communications, that's the name of the game. If you have a modem and a modem lead, then plugging them into the Amiga is as simple as plugging in a joystick. To be able to use it to dial up computer services, you need some software – and that's where this program comes in.

The updates are prolific; translating special symbols and foreign characters for keymaps correctly – a lot of European users found the old version very irritating in this respect; advances like more protocols for sending and receiving programs and files – version 2 recognises Kermit, CompuServe-B and JModem, as well as more established forms; and *NComm* now has a full ARexx port, especially useful in a comms program, because you can now automate dialling up a service, downloading all new messages and logging off, which saves you money in phone bills.

The really good thing about this disk is full documentation. Everything is explained, clearly and concisely, although there is a lot of jargon *NComm 2* is shareware – the contribution is about £25, which seems a lot, but when you see the program you will see why. A registered user will receive a version without the hundreds of little reminders to pay the shareware fee.

Also on the disk is *Zoom 5.40* (a neat Workbench hack that makes windows and screens zoom into and out of view), three archiving programs for making uploaded files smaller (saving phone bills again) and downloaded files usable, and a disk compacter for those who wish to squeeze as much as possible onto a floppy disk – again, all with full documentation.

A word of warning though; all programs and support files on the disk have been heavily crunched, and if you want to take things off the disk (to install onto a hard drive) it will take quite a bit of work. Apart from that, first-class presentation and content make this a disk not to miss for all comms freaks.

CONTACT LIST:

All the Public Domain programs and utilities reviewed here can be obtained from the following PD libraries.

17 BIT: 1st Floor Offices, 2-8 Market Street, Wakefield, West Yorkshire WF1 1DH. 0924 366982

PD SOFT: 1 Bryant Avenue, Southend-on-Sea, Essex, SS1 2YD, 0702 612259

VALLY PD: PO Box 15, Peterlee, County Durham, SR8 1NZ, 091-5871195

TOP TEN UTILITIES OF THE MONTH

Every month, we look at the best-selling utility and game PD disks from a particular library, so you can see what's popular...

VALLY PD

1. TextPlus 3.0EN
2. Amibase Pro II
3. New Superkillers 2.2
4. Mental Image Games Disk 1
5. Air Warrior
6. IBM PC Emulator
7. AmigaFox DTP
8. Pom Pom Gunner
9. MessySID 2
10. TextEngine V3

AMIGA
ONLY

ULTIMATE PD

ONLY 99P
PER

★ DEMO DISKS ★

D264 - Shark Animation (1Meg)
D278 - Madonna Hanky Panky (P)
D240 - At The Movies (2 Meg)
D279 - More Aerotoons (1Meg) (P)
D280 - Amy V.S. Walker Anim
(1 Meg)
D294 - Life Of Brian (P) (2 disks)
D297 - Anti Lemmin Demo (2 Meg)
(2 disks)
D298 - Robocop Animation (1 Meg)
(P)
D300 - Silents: Ice Demo
D254 - Virtual World (1 Meg)
D150 - Windsurfer Animation (P)
D315 - Mr Potato Head (1 Meg) (P)
D316 - Creature Comforts Demo
D318 - 3D Pinball Animation (1 Meg)
(P)
D001 - Walker 1 (1 Meg)
D002 - Walker 2 (1 Meg)
D003 - Walker 3 (1 Meg)
D004 - Cool Cougar (1 Meg)
D012 - Rebels Megademo
D014 - Space Ace Demo
D023 - Stealthy 2 Anim (1 Meg)
D028 - Budbrain Mega Demo
(2 disks)
D047 - RAF Megademo (2 disks)
D045 - Arse Wipe Advert
D059 - Red Sector Megademo
(2 disks)
D062 - Red Sector CeBIT 90
D077 - Good Morning Vietnam
D088 - Silents Megademo
D095 - Outsiders Acid Demo
D115 - Vision Mega Demo 4
D127 - Chubby Brown
D134 - Garfield Demo
D147 - Neighbours Slideshow
D148 - Viz Slideshow
D151 - Robocop 2 Slideshow
D153 - Epic Game Demo (1 Meg)
D158 - Operation Vark
D160 - Exodus Real 3D (1 Meg)
D163 - Probe Sequence
D164 - Slycath Amazing Demo Comp
D168 - Horizon Mega Demo
D169 - Budbrain Mega Demo 2
D176 - Jasper Carrot Demo
D184 - Dragons Lair 2 Demo
D185 Wrath Of The Demon Demo
D187 - Batman The Movie Demo
D251 - Decaying Paradise (1 Meg)
D264 - Hardwired (1 Meg)
D225 - Phenomena Enigma
(1 Meg)
D231 - KGB Mega Demo (2 disks -
1Meg)
D237 - Silents - Global Trash
D240 - Vic Reeves Demo (2 disks)
D241 - Ray Of Hope (2 disks)
D247 - DMob It's A Lame Demo
D284 - Odyssey - Alcatraz (5 disks)
D312 - Anarchy - Seeing Is Believing
D325 - Hynautic Hammer
D327 - Greatest Demos Vol 1
D330 - Greatest Demos Vol 2
D333 - Greatest Demos Vol 3
D345 - It Came From The Desert
Demo
D346 - Harry Meets A ST Owner
D347 - Shuttle Cock Animation
D354 - NASA Slideshow
D357 - KGB Mega Demo 2
D359 - Kefrens Guardian Dragon
D370 - Terminator 2 Slide Show
D379 - Navy Seals SlideShow
D388 - Track Ro Vectra

★ MUSIC DISKS ★

M001 - Seriously Good Music 1
M002 - Seriously Good Music 2
M003 - Seriously Good Music 3
M011 - DMOB Music 2
M012 - DMOB Music 4 (2 disks)
M014 - Rebel Megablast
M016 - Micromix 2
M022 - Amiga Charts Mix 3
M029 - D-Mob Music 3
M023 - Titan Trax 1
M026 - Amiga Charts Mix 5
M029 - D-MOB Music 3
M034 - Arnie Swarzenaggar Total
Remix (2 disks)
M035 - Digital Concert 2
M036 - Digital Concert 3
M037 - Digital Concert 4
M038 - Digital Concert 5
M039 - Digital Concert 6
M040 - RAF Megamix 1
M042 - Bat Dance Remix
M049 - Ben Elton (xxx)
M057 - DMOB Music 1
M081 - Flash 2 (disks)
M102 - Debbie Gibson's Electric
Youth (2 disks)
M114 - Betty Boo - Doing The Do
M121 - Band Aid 11 (2 disks)
M122 - RAF Beat Thiz 1
M123 - RAF Beat Thiz 2
M124 - RAF Beat Thiz 3
M125 - RAF Megamix 2 (2 disks)
M126 - Amiga Charts Mix 2
M127 - Amiga Charts Mix 6
M134 - Miami Vice Theme (4 disks)
M136 - Laurel And Hardy (2 disks)
M141 - JM Jarre - Definitive
M143 - CD Player Demo (1 Meg)
M144 - Flash! Queen (2)
M159 - Techotronic Remix
M161 - Crusaders Bacteria
M183 - Scoopex Beast Sonix
M157 - Digital Concert 5 (V1)
M151 - Crusaders: Genesis
M132 - Depeche Mode Mix Disk
M156 - Seal Crazy Remix (1 Meg)
M185 - I Think We're Alone
M186 - Everybody Dance Now
M187 - Doing The Do (Remix)
M189 - Amazing Tunes (1 Meg) (3 disks)
M190 - Move Any Mountain
M192 - Charly Remix
M193 - What Can You Do For Me?
M194 - Bruno Music Box (2 disks)
M195 - Manic Raves (2 disks)
M199 - Star Trek Theme
M201 - Journey Into Sound
M203 - Looney Tunes
M205 - Vogue CD Player
M206 - Flashing Bytes
M208 - Remember The Time (Remix)
M209 - Enjoy Live
M211 - Rave Around The Clock
M212 - Raver's Delight
M216 - Genesis
M217 - Dirty Digit Songs
M225 - Phil Collins
M226 - The Wall By Pink Floyd (6 disks)
M229 - Desire Lego Land
M230 - Manic Raves Remix
M234 - 808 State Remix
M241 - The Equiliser
M246 - Music Dream 2
M247 - Four Seasons
M248 - Flash Team Music
M249 - Move Any Mountain
M251 - Roger Ramjet
M253 - Crazy Looney Tunes
M260 - Old Soul Remix
M265 - Stand By Me
M269 - My Girl
M271 - Simply Red-Stars (2 disks)

★ UTILITIES ★

U001 - Sound Tracker Collection
(3 disks)
U012 - Mega Utilities (175 utilities)
U024 - Sid Cli Utility
U039 - Amibase V3.76
U042 - Front Disk
U043 - Kim Database
U059 - Clip Art
U062 - Ultimate PD Copiers +
Virus Killers Disk
U069 - Demolisher Utilities
U071 - D-Copy
U073 - Hard Disk Utilities
U074 - Easy Back Up And View 80
U075 - Pascal C Compiler
U078 - A500 + Utilities (For The
A500 +only)
U080 - Turbotitle
U081 - S-Movie
U082 - Graphs
U083 - Drawmap V3.1
U085 - RBase II V5
U086 - Text Engine V3
U025 - Sid V1 6
U091 - Opti Utilities 2
U093 - PCQ Pascal
U094 - M.U.K V2.1
U095 - Zerovirus + Bootx V4.30
U096 - ST Emulator
U098 - Amibase V3 6.7
U099 - M-CAD
U101 - C Manual V2.00
U103 - Iconmania
U104 - Messysid 11
U105 - Insanity Tools
U106 - Imploder V4.0
U107 - N-Comm V1.921
U108 - Amiga MCAD
U109 - D Paint Cartoon Brushes
U111 - D Paint Font Disks (4 disks)
U112 - Ham Radio Utilities (5 disks)
U113 - Programming Disk (2 disks)
U117 - Sound Applications (2 disks)
U119 - Video Applications (2 disks)
U128 - The Comms Disk
U129 - D- Paint Clip Art (2 disks)
U130 - Video Graphics (4 disks)
U132 - Genealogy (1 Meg)
U066 - C-Light (1 Meg)
U135 - New Super Killers
U138 - ElectroCAD V1.4 Demo
U139 - Spectra Paint V3.0
U140 - Language Tutor
U145 - Database Master 2.0
U146 - Dynamite Brush Fonts
U147 - Textplus Word Processor
U149 - Med V3.10
U151 - Dice V2.06A
U152 - Pagesetter Clip Art (8 disks)
U154 - Night Flyers Utilities IV
U156 - Vector ball Editor (1 Meg)
U157 - Antivirus V3.14
U158 - Kids Paint
U159 - Text Engine
U160 - Windows Bench
U161 - PDS Utilities Nol Printing Utilities
U163 - NComme V1, 921
U164 - Work Bench 2+ Work Station
U165 - Video Screens
U167 - Cursor Basic Compiler
U168 - JRComm V1.02
U171 - Super C. Commands
U172 - P. Suite V1.4
U173 - The Ripper Guide
U174 - Jam Ripper V1.7 Jam Cracker V1
U175 - Beatrix Potter Clip Art
U177 - Thief Sound Ripper V3.0
U178 - Faulty Towers Samples
U179 - News Flash 21
U183 - Swag No 4: Fractals
U184 - Little Bench
U185 - Plotting + Graphics: Plot-X-Y

★ GAMES ★

U186 - Draw Map V3.1
G001 - Star Trek 3 (2 disks)
G006 - Breakout Construction Kit
G008 - Board Games (Monopoly etc)
G014 - Buck Rogers
G015 - Star Trek (3 disks, 1 Meg)
G016 - Tennis (1 Meg)
G020 - Train Set
G024 - Pipeline
G026 - Treasure Hunt
G031 - Drip!
G033 - Jeopard (1 Meg)
G034 - Dragon Cave
G037 - Seven Tiles
G038 - Pom Pom Gunner
G043 - Mental Image Games Disk
G056 - Strategy Games
G057 - Simpsons Game
G059 - Bionix II (1 Meg)
G062 - Atic Atac (1 Meg)
G065 - Battle Pong (1 Meg)
G066 - Frantic Freddie
G068 - Air Ace II
G069 - Down Hill Challenge
G070 - Llamatron
G071 - Sky Flyer
G074 - Revenge Of Mutant Camels
G075 - Jet man
G077 - Asteroids
G078 - Twintris
G079 - Card Games
G080 - Battle Cards
G081 - Mind Games 21
G083 - Sword Of The Warlock
G084 - Solitaire
G086 - Scramble
G087 - Dungeon On Nadroj
G088 - Royal Boulder Dash
G090 - Sub Attack
G092 - Mega Ball
G093 - Air Warrior
G095 - Super Skoda Challenge

★ SPECIAL OFFERS ★

**UNBRANDED
BLANK DISKS
38p EACH**

DISK BOXES

3.5"Cap 10.....99p
3.5"Cap 40.....£4.00
3.5"Cap 80.....£6.50

Mouse Mat.....£2.99
1000 Disk Labels...£9.99
512K Memory Upgrades
With Clock£32.50
Without Clock.....£28.50

**We also stock Fred
Fish disks 1-596 &
T-Bag 1-59**

Please make cheques and postal orders payable to:
Ultimate PD.

The Ultimate PD Mag - Catalogue disk is available
for 75p or free with orders of 2 disks or
more.



PLEASE SEND ORDERS TO:

**ULTIMATE PD
44 FESTINIOG ROAD,
GABALFA, CARDIFF CF4 2QS,
WALES**

All disks are 99p each, some titles are on more
than 1 disk.

Please add 50p p&p to the total order.
European orders please add 50p per disk and
the rest of the world add 75p per disk



Q: HOW MANY PROGRAMS CAN YOU GET FOR £30?

A: 30!

Public Domain is your essential monthly guide to the world of free software. For as little as a pound you can pick up games, utilities, even fully-fledged business packages for your PC.

- New look issue! Redesigned to be even clearer than ever before
- Hundreds of programs reviewed and rated each and every issue
- In-depth features that tell you all you need to know
- Lower price! – For only £1.95 you could save yourself hundreds

DON'T MISS ISSUE SEVEN ON SALE 7TH MAY

Yet another superb magazine from Future Publishing, the company that brings you Amiga Format, ST Format, Amiga Power, Amiga Shopper, PC Plus, PC Format, PC Answers...

Future PUBLISHING

AMIGA · PC · ST

THE WORLD OF FREE SOFTWARE – YOUR MONTHLY GUIDE

PUBLIC DOMAIN

ISSUE 7 • £1.95
JUNE 1992

THE LATEST PD, SHAREWARE & LICENCEWARE REVIEWED

WELCOME TO THE HOUSE OF FUN

Play arcade classics and save those 10ps ...PAGE 9

IT SHOULDN'T BE ALLOWED...
We uncover the seedier side of PD ...PAGE 12

THE PRETTY FACE OF COMPUTING
The best in Graphic User Interfaces ...PAGE 73

FREAKED OUT BY FRACTALS!
Take a trip into the exciting new world where calculated chaos creates mind-blowing patterns ...PAGE 33

PLUS: PUBLIC EYE: BUDGIE UK • NEW SERIES: DISK MAGAZINES • 21 JOYSTICKS UP FOR GRABS • COMMS

Future PUBLISHING





CUT, TICK & POST.... CUT, TICK & POST

Telephone or Fax Hotline (0702) 466933
PD Soft (AF36) 1 Bryant Ave, Southend-on-Sea, ESSEX, SS1 2YD

LATEST AMOS & FISH DISKS

All Fred fish disks are Workbench driven but knowledge of CUI/Shell may be required to run some of the programs. Most programs will work with Wb 2.04

APD151 UNDERSTANDING AMOS The Amos Tutorial Program Disk. A must

APD356 POWERBASE v2.0 This is an easy, friendly and Powerfully database which can handle 10,000 records.

F579 OCTAMED A music editor which was originally designed for making music for programs, idemos, games, etc, but works well as a stand-alone music program as well. Octamed is the 8-channel version of MED.

F580 WORLD DATABANK v2.2 Using a data base from the CIA, this program will plot world maps.

F583 SUPERSPELL A global spelling checker that checks your spelling no matter what program you are typing under. Comes with a 9000 word dictionary, which you can edit, add to or replace completely.

F590 SUPERDUPLEX v2.01 A very fast disk copier & formatter. Verified copies very quickly indeed.

F593 ANALYTRIM (2) An integration of AnalyCalc spreadsheet & RIM-5 Database management

F601 PP v1.4 Use this Patch to load Power Packer files into any standard word processor. I.e. Plus or Ledit.

F602 MATHS ADV A simple game where you the young adventurer, must try to escape the Kings Mather's adventure. After each room the questions get harder.

F621 IE Icon editor with import & export commands.

MULTIPLAYER v1.17 Plays most music progms modules.

F628 LEGEND OF LOT-HAN v1.02 is an adventure game in the vein of the Ultima game series. Includes colourful graphics, hordes of monsters & puzzles to solve.

F629 ROCKY Another boulderdash clone. This one has loads of levels & is joystick or keyboard driven.

BUDGET SOFTWARE (A500P Tested)

FREE POSTAGE & PACKING (P&P) NO CHARGE	
1 Budget Title £7.99	2 Budget Titles £7.79 Each
B13 ARCADE TRIVA X	BT13 FANTASY WORLD DIZZY X
B120 DRILLER X	BT21 CALIFORNIA GAMES
B122 FORTGOTTEN WORLDS X	BT25 INDIANA JONES
B127 MOONWALKER X	BT30 SWITCH BLADE X
B143 BUBBLE BOBBLE	BT44 PLATOON X
B145 POWER DRIFT X	BT46 NEW ZEALAND STORY
B147 CRAZY CARS X	BT48 DRAGON NINJA
B149 CABEL X	BT50 RAMBO III
B151 BEACH VOLLY BALL	BT52 HEAD OVER HEALS X
B153 OPERATION WOLF	BT54 R-TYPE X
B155 THE LAST NINJA	BT56 LOMBARD RAC RALLY
B157 GAMES SUM EDITOR X	BT58 CS ALPHANT ANICS X
B159 FAST FOOD	BT60 NINJA RABBITS X
B162 WACKY DARTS	BT72 ULTIMATE GOLF X
B173 THUNDERSTIKE X	BT74 RESOLUTION 101 X
B175 MANIX X	BT76 MINDBENDER X
B177 1ST DIVISION MAN X	BT79 PRO BOXING SIM
B181 X-OUT X	BT82 STUNT CAR RACER X
B183 RICK DANGEROUS X	BT84 IK-X X
B185 SKY HIGH STUNT MAN X	BT86 CHOCOCOPY X
B187 RENEGADE	BT88 CHASE HQ X
B189 IVAN-HOE X	BT91 RAINBOW ISLANDS

LATEST BUDGET (Phone for A500 Plus Compatibility)

B192 MIDNIGHT RESISTANCE £194 TUSKER

B195 1000 CC TURBO £196 CYBERCOP

B197 STRIDER £198 Z-OUT

BT100 TOYOTA GT RALLY £101 JAMES POND

BT102 VOODOO NIGHTMARE £103 VENUS FLYTRAP

BT104 COMBO RACER £105 APACHE FLIGHT

BT106 MAN UTD £107 NAVY MOVES

BT108 PUFFY'S SAGA £109 SHADOW WARRIOR

BT110 T-PACK £112 YOGI 3

BT113 FI TORNADO £114 QUATRO FIGHTERS

TITLES PRICED @ £8.99 Each / £8.00 Each for 2

DOUBLE DRAGON The original Karate beat em up

B167 BLOODY RANGER Superb Graphical adventure

B168 LOCKWOODYCH Brilliant Role playing Game

B190 CAVITAS One of the best shoot em ups games

B193 MONTY PYTHON'S STRONG Graphical adventure

B199 ITALIA 90 An excellent soccer computer game

BT106 SUPER OFF ROAD RACER An excellent super Sprint course with extra effects & Special weapon's

BT111 THE HUNT FOR RED OCT A Sub simulator

Phone or Write (SAE) for a free upto date Printed Catalogue. details of all the best disks & All Budget software.

FLETCHER VIDEO FONTS - £15.00 Per Pack

Packages in Stock FFP1, FFP2, FFP3, FFP4 and PD-SOFT (UK) Only have FFP5 The best pack yet

Six disks packed with a varied assortment of coloured fonts in many colours, shapes & sizes. For use with Dpoint programs or any Video production utilities. This pack has some totally outstanding fonts and for only £15 they give you over 70 fonts to play with. Best produced & totally

TELEPHONE ORDERS & COLLECTING DISKS

The Telephone hotline is open six days a week from 9am to 7pm (Week days) & from 10am - 4pm (Saturdays). You can now collect any disks of our New office address 6-8 DUNHAM ROAD, SOUTHEND-ON-SEA, SS1 2YD

EUROPEAN ORDERS - NO POSTAGE CHARGE

When ordering from within Europe remember that there is a min order of 5 disks. All orders sent by AIRMAIL Free

INTERNATIONAL ORDERS ONLY

All orders are sent by Air Mail. Please add 20% (Minimum £2.00) to the total of the order, towards the postage. International Cheques must be drawn on a U.K. bank.

VARIOUS UTILITIES

V13 PLAY & READ (2) A collection of education programs for the under 7 year olds.

V16 FISH TANK SIMULATOR A program that simulates an aquarium. Visually pleasing.

V28 WORD WRIGHT & AMIGA SPELL, Contains over 9,000 words & more words can be added.

V29 HOUSE HOLD INVENTORY Means of maintaining all your House hold possessions.

V41 DPAINT ART Contains loads of pictures for you to mess around with. Loads into your Dpoint.

V48 TV & VIDEO GRAPHICS (8) Packed with background screens for your video productions. Different types of graphic styles. Peel, takes an IFF Picture & peels it down the screen. & Much More.

V86 VIDEO PRODUCTION (2) Both disks are packed with video & Genlock utilities.

V109 PRINT STUDIO Excellent for printing pictures or text. An excellent program for all printer owners.

V191 MASTER VIRUS KILLER Virus Checker & Killer. With Excellent options. Includes search disk.

V193 THE EMULATORS Covers Various (2) Formats which includes CPM, IBM-PC & ST. Require 2 drives.

V194 M.R.BACKUP HD An excellent Hard disk backup program. Backs up all or any part of the drive.

V195 GRAPHIC INTERCHANGE Interchange graphics Between Atari 5/PC Graphics to the Amiga.

V215 DISKMASTER v3.2 Copies files from one disk to another. DISKSALV Corrects & repairs.

V261 TEXTPLUS VERSION 3.0 This disk is not just an update but completely New Word processor.

V262 DUPLICATION & BACKUP: Super Duper, Turbo copy, Sanity copy & PCopy. Four new copiers to backup your originals for save keeping.

V277 FORTRAN-77 v1.3c Compiler, linker & run time support library. F470

V279 CROSSWORD CREATOR A program that creates crosswords. UPDATED VERSION

V284 MCAD PROGRAM The Object Drawing Program for the Amiga ie CAD

V285 EDUCATIONAL: TYPING TUTOR A Simple typing which measures your speed on the keyboard.

V291 POSTSCRIPT INTERPRETER v1.5 Down load any Post Script Fonts to your printer. Like a Laser Printer.

V298 NORTH C v1.3 (2) The most famous C. language on the Amiga. Encodes all files required.

V301 EYE OF THE BEHOLDER HINT BOOK IFF Introduction, Background, Maps, Strategy & Solution.

V304 CHAOS STRIKES BACK HINT BOOK IFF Introduction, Background, Maps, Strategy & Solution.

V306 A-GENE v3.125 Latest version of the Family Tree program. Reviewed in CJ Amiga.

V311 JACK NICKOUS COURSE DISKS (5) A selection of Extra courses designed with the construction kit.

V323 ANALYTICAL SPREAD SHEET (2) This is the best spread sheet program to date on the Amiga.

V327 THE SOUND TRACKER CONVERTER Load in a sound tracker tune & save an executable file.

V330 RED SECTOR EXTRAS DISK 1 On this disk are 32 point fonts, 16 Point fonts, vector stars, Star fields & music Space Journey Lorna. By the deatzone Troopers.

V331 RED SECTOR EXTRAS DISK 2 On this disk are Big logos, little Logos, Vector Stars, Starfields, Bob Anims, Vector Objects, Vector Ball Objects & various Fonts.

V332 AMIGA PUNT PROGRAM Predict which horse will win with this horse prediction program.

V333 KING JAMES (4) This version of the Bible by King James has been typed onto disk & packed on (4)

V338 TRANSFORMER v3.3 This is the Latest version of the IBM Emulator. Require an MS-Dos disk.

V339 SPECTRUM EMULATOR DATA DISK 1 Adventure Classics needs v216 or v443

V340 TSB VECTOR DESIGNER The Special Bothers presents The TSB Vector designer v1.1. This program will create filled vector objects, line vectors & Bobs.

V341 CLIP ART COLLECTION 2: Eight more disks fully packed with excellent clip art (8)

V349 VSD v1.06 Replaces the CU Command line & makes life very easy. Recommended for all

V350 BUSINESS CARD MAKER Design your own Business cards on the Amiga.

V354 PDS UTILITIES No 13: FREECOPY, Removes protected games copy protection so that the user can install them on his/her hard disk. DCAT, Can create your own disk catalogue. SCENERY, Creates some excellent fractal based land scapes. NUKE v1.4

V358 GENESIS LANDSCAPE Sculpt or Mould any fractal landscape in various types & sizes. Shareware

V361 PDS UTILITIES 14: MODCONVERT, Program. NOISE PLAYER, Program. MULTI PLAYER, Program. which will play various modules not just one type

V365 RED SECTOR MODULES (MUSIC): Various music modules for use with the RSI Demo Maker

V366 600 BUSINESS LETTERS There are over 600 Standard business letters on this disk. Can be used as they are, or insert some parts into your own letters/text.

V390 THE DESK TOP PUBLISHING PROGRAM The first amiga PD Desk Top Publishing program. Includes various extra features over the old Word processor, Text Editor, Graphics editor & loads more.

V392 AMICASH BANKING The best banking program that I have ever used on the Amiga. easy controls.

V393 PDS UTILITIES No 15: BOOTGAMES, The idea is to install one of two games onto your disks bootblock. Breakout & Breaker. Very simple to use. BOOTGEN, Another boot block program. BOOTPIC, This program will install any IFF picture onto your disks bootblock. TRAINER MAKER.

V394 CHEMESTETIC, A program that draws molecules using the collette model. Excellent effects.

V395 UEDIT WORD PROCESSOR v2.6h This is an excellent Word Processor with various learn modes. Menu customization, Hypertext, On line help. A teach mode. Split windows, Copy, Paste, Undo & More.

V396 PDS UTILITIES No 16: DATAEASY, Excellent Database program. A nice menu driven system. LANDSCAPE, Based around a landscape drawing

V397 MANDELBROT ADVENTURE KIT A well done mandelbrot Generator with full source Code

V399 PDS UTILITIES No 17: STITCHERY, A niting pattern program. SAVOIE, Video production scroller

V400 RAY TRACER CONSTRUCTION KIT A Ray tracer for the Amiga computer. Load Workbench first

V401 WINDOWBENCH v1.0 (2) An excellent Workbench II replacement for all v1.3 users. Recommended.

V403 AMOS UPDATE v1.32 This is the latest RAMOS update for the Amos Programmer

V410 PDS UTILITIES No 1: PRINTING UTILITIES PPTYPE, PPSHOW, ABFD, View, Tiny Print, FASTJET, A program for Deskjet 500 users you want to use the resolution enhanced graphic set. GWPPrint II.

V413 WORKBENCH 2 & WORK STATION This is not just another workbench clone. It's a collection of utilities with the Workbench theme. (2)

V415 VIDEO SCREENS-1 Excellent back ground pictures for video production work. Nice back drops.

V417 SUPERBENCH & EXTRAS (2) An excellent replacement disk with more utilities than the original WB

V420 CURSOR BASIC COMPILER Compile any Amiga Basic program with this utility disk.

V423 C: COMMANDS This disk is filled with utilities which can be used in Start-up-sequences

V424 PDS UTILITIES No 18 Utilities include. Anti-flicker program, Said to stop the flicker in High Res. Atari ST Emulator. Program to turn your amiga into an ST

V431 IMPLODER v4.0 Reduces file size for storage on hard drives over your own collection disks.

V433 ANIMATION STUDIO An excellent Animation creator for you to make your own.

V438 OPTI UTILITIES v2.0 This disk is packed with some excellent hard disk utilities.

V439 AMIGA C: MANUAL II This manual is the complete C. manual for the Amiga & describes open & work with all parts of the C. system. It also contains various examples, some simple & some more complex all the way through the disks a tutorial is there to help you out. (4)

V443 SPECTRUM EMULATOR v1.2 By KGB. Main updated feature is it now has sound ability.

V444 PRINTER DRIVER UPDATE DISK III Now contains instruction on how to install them. All previous drivers included on this disk. Over 90

V445 JRCOMM v1.02 This is the latest version of the excellent modem based computer program.

V455 LAND BUILDER A fractal generating program to generate landscapes.

V463 SUPER C: COMMANDS The disk is not as full as some others but comes with full instruction.

V468 DIGITAL ADDRESS BOOK Collect & save your address lists on computer. Shareware

V475 P.SUITE v1.4 A collection of programs called P.Write, a simple word processor, P-Draw, P-Render and much much more. Excellent disk

V479 CHESS & CHESS UTILITIES A collection of chess related Puzzles, Programs & Utilities

V483 THE RIPPERS GUIDE A collection of help full utilities for people who rip pictures & sounds.

V484 ADVENTURE SOLUTIONS (2) Another good collection of adventure solutions for various games.

V489 AMIBASE PROFESSIONAL II The latest updated version of the excellent Database program. now includes various excellent new features.

V490 MESSY SID II This is the latest version. It will read MS-Dos disks and transfer any text files to & from the PC disk / Your Amiga. So you can do work on an IBM or an Amiga and swap text between them.

V492 JAM RIPPER v1.7 & JAM CRACKER v1.0 Also contains an excellent music ripper program.

V493 DESKBENCH (3) This is an excellent Workbench replacement with special utilities.

V497 BEATRIX POTTER CLIP ART An excellent collection of clip art for any DTP program or Dpoint.

V498 THEE SOUND RIPPER v3.0 Finds Sidman 1, 2 (Midli), J-Horn cracker, future Composer, Sound monitor, Noise/Protracker, Startracker, Delta, sound system, david Whioaker & Noisepacker

V499 STAR CHART v1.2 This is an excellent star plotting program with some interesting features.

V509 MED v3.2 This is another update to the Ultimate sound music Editor program.

V510 LITTLEBENCH This workbench replacement is the first one for the new Amiga 500p Computer

V515 THE A64 PACKAGE v2.0 (2) A very complete C.64 Emulator. Actually runs faster than 64. Runs 64 basic. Transfers disks from your original 64 disk drive with a shareware load

V517 VIDEO & AMIN: VIDEO DB, A program for keep track on your video tape collections. RTAP, Lets you play large Anims on small Mem machines.

V518 IMAGE LAB Performs many effects from simple averaging to fast fourier transforms. Tools On Top, Does lodes, colours & gray bar generation

V519 STILLSTORE Used to create over the shoulder graphic inserts like the 90 clock news.

V520 GRAPHICS: AGRAPH, Creates colourful pie, bar and line graphs. PICBASE, Shows reduced versions of all of your IFF pictures. ** Requires V522

V521 PLOTTING & GRAPHICS: PLOTXY, A powerful full featured plotting package. PLANS, A well done computer aided drafting program.

V522 ARP v1.3: Corman v1.4, Makes many improvements to AmigaDOS & makes your system easier to use. Includes full users developers guide.

V523 DICE C COMPILER (2) Matthew Dilons full featured powerful C compiler & environment system.

V525 LABEL MAKER v1.3 An excellent disk printing program with various new features.

V526 DRAW MAP v3.1 (2) Will now generate any 16 colour palette with user control. New features include larger maps with national boundaries, improved help and printing. 1.2Mb. (IBM version on disk V263)

V528 PDS UTILS-20: SUPERDUPER, Another excellent disk copy program. Latest update with new feature. DiskSpeed & FullView.

V529 FRACTAL & SCULPT Ad: Tree 4d, Creates sculpt 4d trees with leaves. Colour 4d. IFSGen & Plasma.

V530 BUDGET A program to help managing personal finances. This is an update to disk V280.

V536 CATALOGUE UTILITIES A collection of utilities used to Catalogue disk/ Video/ Tape collections (2)

V543 DISK STATION (2) An excellent workbench replacement with built in utilities like Sid and others

V546 KIDS PAINT A painting program designed for children. Includes various colours and speech.

V547 RADBENCH v1.4 Another workbench replacement/Enhancement disk.

V549 ELECTROCAD v1.4 Another Updated on the cad drawing preview written in Amos.

V550 KEFRENS POWER UTILITIES: NewTopaz, Power Fonts, Create, Edit or change any 8x8 or 16x16 fonts. Window, Change size of dos windows.

V551 THE SUPER KILLERS V2.3: BOOT X v4.40, This is the best virus killer disk to date kills over 232 virus & may be more. Includes excellent killers. Including VC v6.0, Zero virus III v1.20 & VT v2.37.

V552 PRINT UTILITIES DiskIt, HyperCat, Label print, Super reltab, LabelBase III

V553 SHADOW UTILITIES Roster Blaster II, Simplesinal & Text Writer v1.0.

V554 R.S.I. MUSIC MODULES 2/3 Another selection of music from Red Section. (2)

V556 RED SECTOR HELP DISK Another disk to help you use the Red Sector Demo Creator.

V557 TOO SEXY UTILITIES A very large selection of utilities including, V-Checker, Print Studio, Super Duper & Nuke. For to many utilities to list

V559 PUMA TRACKER v.99 Another good sound tracker clone. Used to create the music from Toki.

V560 10 AMIGA PD COPIERS A collection of copiers like amigaCopy, Coder copy, Pcopy, Ratlecopy & more.

V562 MORE UTILITIES PopDir, Exchange, Qcal, Excellent little calendar program. PhoneDir.

V567 PRINTER DRIVER GENERATORS A selection of utilities with various excellent Printer Driver Generators.

V569 DUNGEON MASTER MAPPER A little tool that creates maps of dungeons land eventually towns which can be used by a DM for use in a AD&D game.

V570 CHRIS HAMES UTILITIES: DIRWORK v1.51, Excellent file copier simual to diskmaster & Sid but contains more commands to hand. Recommended.

V571 WHOM II v2.02 (2) An update to the Dr Who database program. Goes all into an Dr Who prog.

V573 FILE & HARD DRIVE MANAGEMENT (2): HDCLICK v2.0, A program selector to make Hard disk Menuus. Starts with gadgets FILE MINER, Utility for maintaining files & Directories. DOSCONTROL, Tool that combines the functionality of many separate tools.

V575 HOME BUSINESS PACK (6) An excellent selection of utilities based on word processing, Data Management, Spread Sheets, Accounts & Printing.

V581 PDS PRINTING No 3: PRINTER DRIVERS, HP Deskjet 500 & 500 Colour, Canon BJ10e, BJ130, BJ300, Nec24p, Oki24p, 39p, Star24p, Panasonic9, Seikasho9. HPMODE, For use with Deskjet 500

V582 DB, A Database with upto 50 fields, max of about 1.2 million records. CLICKDOS II, is an Amiga Dos enhancement utility. FILEFIND & SUPERVIEW v3.0

V583 ICONEDITOR III v2.0, Can create Icons upto 640x200 pixels. DOCTORICON v1.0, Imports images as icons, Can Edit & Create any Amiga icons.

V584 EDUCATION: FASTFACTS, Everything you ever needed to know about the solar system.

WORLD MAP, Produces different sorts of world maps. PLANETS, Instant locations of planets. MATH MOUNTAIN

V585 ARCHIVERS A selection of most archivers, like IHarC, Zoo, IHWarp, Pak, LZ, PKAZip, Zap, Zippy & more.

V586 FONTS & C: COMMANDS: DISKSALVE, Repairs damaged disks. SWEEP, Free unUsed allocated memory. FONTASSIGN, Assigns fonts to the SYS path.

V587 GELIGNITE FONTS (2) A selection of Amiga fonts for use with any DTP Package or Dpoint disks.

V590 CRUNCH N COPY A selection of programs that will crunch files & Copy disks for safe keeping

V591 HANLAB IFF CONVERTERS GIF to IFF & back. Used with the IFF Machine to convert Pic to the IBM

V592 MICRO EMACS This is an excellent Word processor also comes with a Spell checker program

V593 TEXT ENGINE v3.0 Another excellent word processor program Simple but will do the job

V598 DATABASE WIZ This program will record all your Names & Address. Easy Database program.

V599 BBASE II v5.3 This disk is one of the most well known database program. Recommend.

V600 DELTA MUSIC EDITOR An excellent Music editor program. A new flavor in music creation.

V601 AUDIO MAGIC v2.0 The latest collection of music based programs. Excellent selection.

V602 UNICOPI New disk copy program with various extra features with onboard features.

V603 POOL FORCAST An extra helping hand for people who monitor the pools.

V604 PD COPY v3.0 New disk copy with some extra commands & quick copy modes built in

V605 PRO CALC v1.0 An excellent production which will produce graphs. See AF32 for review

V606 SAMPLE MAKER v1.0 This program works in a similar way to synthesizers, just choose the wave form, alter it to taste & insert into your sample.

V607 PRO TRACKER v2.0 A music Editor, which you can create music with. Also load any sample.

V608 DCOOPY v2.0 This is the best copier yet, powerful commands with deep scan modes.

V610 GOLF SCORES v1.82 Golf scores just got better with easy charts to keep your averages upto date.

V611 FOOTBALL LEAGUE EDITOR Update your leagues positions for instantfootball league Info

V620 ASPICE v3.0 Circuit analysis program which has been modified to run on the Amiga

V621 EDWORD v2.2 is a fully featured & operational text / Word processor which offers all standard features & More like Powerful search routines, use any 8-point Amiga font & has a built in virus checker.

V624 NIB COPIER v2.0 The latest update to that excellent disk copy program. Requires 2 disk drives

V625 NCOMM v2.0, it's here the long awaited update to the best modem related program on the Amiga. Also contains a New version of LHarc.

V627 DPOINT FONTS No's 1-3 (3) The latest selection. Fonts for use with any IFF DTP Program (3)

V630 AMICASH Another excellent program to keep a track of all your checks & expenses.

V634 DUNGEON MASTER II MAPS IFF maps for FIL's Dungeon Master II. Load through Dpoint.

V635 IBM EMULATOR This is the best IBM Emulator which supports various colour monitors unlike all the others. Voted best shareware program.

V636 SHADDES & FADES: TURBO TITLE, Video titler especially suited for inserting film subtitles. STAR BLANK, Blanks screen & displays a 3d Star Field.

V637 TWIN EXPRESS v1.1a (2) Trans any file(s) direct from an Amiga or IBM PC. By connecting the Two machines together with a null modem cable. Currently runs at board rate 115200. That's fast

V640 SCALABLE FONTS (5) Excellent fonts for use with any Desk Top Publishing Program. A PD First

THE STAR TREK SELECTION

AT05 KLINGON D7 CRUISER, fires torpedoes while passing by NCC-1864 RELIANT, Very good anim indeed.

AT10 ENTERPRISES, Leaves the Star station dock. NCC 1701-A. The classic original Animation

AT17 THE TWOK NCC-1860, Reliant & the NCC 1701-A-Enterprise. MENSCH ROBOTER

AT18 TWOK-O, Anim NCC 1860 Avenger & NCC 1701-A-Enterprise. NCC 1089 Grissom.

AT22 APPROACHING VESSELS, Animation, Binary Flight Wireframe landscape by T.Richter

AT23 STAR TREK FLEET MANUEVER, NCC-1940 Fly over & by animation. excellent classic

AT33 THE PROBE II, Animation. BRID OF PREY, Animation from Star Trek. KLINGONHIT.

AT34 LEAVING SPACE OFFICE, Animation. DOCKING, Animation from star trek. ATTACK MODE, Bird of Prey Scout hip in attack mode.

AT60 STAR TREK THE NEXT GENERATION, This game is by Terry A. Mc Intosh. v1.47

AT81 THE ULTIMATE STAR TREK (2) Game by Tobias Richter. Now with English instructions.

AT222 STAR TREK THE NEXT GENERATION This is the latest quiz game based on the Next generation (2)

SMAUG120 THE STAR TREK Game by Eric Gustabson US import requires 1Mb & (3) disks

SMAUG156 THE STAR TREK Game by Jimbo Barber The American version 1Mb & (2) disks.

AMUSE19 TREK73, A STAR TREK Battle Simulator where you can attack klingons & Romulans

V367 STAR TREK INFORMATION A Database of all the original series. Very Detailed

V616 THE FINAL FRONTIER ISSUE 1 This is a disk magazine based on Two disks both packed. (2) He are the best NEW Mega demo's from our collection from the past 2 months. The BEST are listed below

2307 AMY AT THE MOVIES II (4) 1Mb Only

2311 AMY vs THE WALKER II (2) 3Mb

2384 AMY AT THE BEACH (2) Probely the best animation by ES to date, Excellent 3Mb

2427 CAMOUFLAGE ANIM 1Mb

2428 MR POTATO HEAD THE CIRCUS ACT (2) By Chris Hill. know this is not an ES Anim but it up to his standard & features one of his characters The Harrier. Excellent story

2430 SKUNKS & HUNKS-POGO II Animation 2Mb

2430 AMY302 AMYHIST Introduces Amy the squirrel

SMAUG303 BATMAN, Another Animation VTOL, about a Harrier vs Propeller plane contest.

SMAUG305 HOW TO RUN, How to run into a wall Very funny Animation by Eric Schwartz.

SMAUG306 AMYWALKS, Anim of Amy the squirrel Walking. AMYJOGS, Anim of Amy the Squirrel Walking

THE GAMES SELECTION

1073 TETRIS ORIGINAL This is the closest game to the original tetris computer game. A Classic

1420 DTRIS This is the best 2 Player Tetris game.

1454 MEGA BALL An excellent Arkanoid game

1486 SOLITAIRE & SOLITAIRE ROYAL Card games

1561 TRITWIS This is the best version of Tetris on the Amiga, with 1 player, 2 player & 3 Payer options.

1735 ASTEROIDS THE ORIGINAL Another old classic. This is the original classic computer game.

1747 LLAMATRON GAME 2001 By Jeff Minter Brilliant stuff & An excellent production. Shoot to kill

1749 SCRAMBLE The Original Remember that old classic well is now on the Amiga The Shoot em up

1870 PATIENCE'S, This is the best version to date. DOMINOS, Play vs the computer or another player

1977 POM POM GUNNER Shoot down the incoming world war II air planes in this Operation Wolf type game

1981 TRUCKING ON A Truck traveling adventure Trading game. An excellent simulator. (2)

1984 AIR WARRIOR The first real flight simulator on the Amiga with various Air planes to Fly

2018 JETMAN Another Spectrum classic converted to the amiga. It's JetPak with all the original sounds.

2022 SEA LANCE The first Silent Service type sub war game within our Amiga PD collection.

2054 ATIC ATAC A rendition of the game from the original Spectrum computer. Graphic Maze adventure

2161 ETHOS GAME An excellent new role playing/ Strategy game. Load through workbench.

2162 BATTLE OF BRITIAN WAR GAME 2 Strategy war games which both need loading through Wb.

2164 DUNGEON ON MADROJ This is the best Dungeons & Dragons Public domain type game

2173 CARD GAMES, Various card games titled Cribbage, Blue Moon, King, Patience & Hearts.

2177 MISSION X: RAID II This is a shoot em up game in the style of SWW & 1943. Very good game

2178 SURVIVOR A space based adventure game within the Aliens theme. Nice colourful graphics

2179 ADVENTURES IN HELL A collection of six games, Jedi, Star trek, Atlantis, Ring & indication.

2180 SKODA CHALLENGE An excellent 4 player hotRod game written in Amos. Simple but good fun.

2185 BATTLECARS Excellent Solid 3d Graphics. Travel around, track down the other cars & destroy.

2199 PARACHUTE JOUST You are falling down to earth & must take the Parachute from the other player.

2219 NAPOLEONIC WAR SIMULATOR v5.0 An excellent simulator program. Sent direct by the Author.

2220 STRATEGIC GAMES, Eternal Rome, Lords of Hosts, In Moonshine. An Excellent collection of games.

2221 MIND GAMES 21 of the best Mind games to challenge your mind not your shooting skills.

2224 SWORD OF THE WARLOCK A Bards tales / Eye of the Beholder adventure game packed on three disks. The best Shareware role playing game on the amiga. Excellent Adventure. (3) 1Mb (2 Drives)

2265 HOLLYWOOD QUIZ, A nicely produced quiz game with a choice of subjects. DOWNHILL SKIING

2272 BLACK JACK LAB Play Pontoon upto 7 Players. The computer plays banker & knows the popular versions of the game.

2278 CARD SHARP A very professionally presented selection of solitaire type card games. Excellent versions

2279 SUB ATTACK v1.0 Control the torpedoes & sink the enemy ships as they sail past. LANDMINE.

2280 DIPLOMACY v2.0 A classic strategy game loosely based on World War 1. A very detailed game.

2313 REVENGE OF THE MUTANT CAMELS By Jeff Minter The ride of a life time with mutant camels

2357 SPACE POKER The alternative Poker Game

2411 TOTAL WAR The board game version of Risk

2412 FORMULA 1 SIMULATOR Anaditive simulator

APD329 AMOS FRUIT MACHINE II As near as possible to the fruit machine found in Pubs & Arcades.

SMAUG312 AMI MORIA v.2.22 This is the latest update to the Original Moria adventure game. Better graphics, and the latest adventure to date. Excellent

EASY ORDERING INFORMATION & ORDER FROM

ORDERING BY POST:

When ordering disks please tick the boxes to the left of the disk numbers (Any coloured pen, Hi-lighter or just just outline the disks). After selecting the disks/software that you require, Please fill in your Name & Address on the order form provided. Cut out or Photocopy this advert. Hand written orders are accepted. & Post to the address Above. Cheques & Postal orders should be made payable to: PD-SOFT. If you have ordered before please tick the account Number box.

NAME _____

ADDRESS _____

POSTCODE _____ A/c No _____ TELEPHONE _____

CREDIT CARD NUMBER (MASTERCARD or VISA) _____ EXPIRY DATE _____ TOTAL PD PRICE £ _____

TOTAL PD DISKS # _____

PRICES ARE PER DISK	A500 PLUS SPECIAL NOTICE (X) = IT WORK
---------------------	--

KCS Power PC Board

SEE US AT
AMIGA SHOPPER
SHOW STAND
D32

PC EMULATION FOR YOUR AMIGA

About...

The KCS Power PC board is a complete #11MHz 1Mb PC sub-system that can be fitted to any Amiga in minutes.

Based around NEC's highly successful V30 CPU, the Power PC Board offers a very high degree of compatibility at machine language level, yet runs faster than an equivalent Intel 8086.

The 1Mb of Autoconfig™ memory can be accessed by all current Amiga models including the A500 Plus. Even the original A500 can access 512K as a standard expansion with clock; plus a 512K RAM disk.

Adored by critics and users alike, the KCS Power PC Board is a real alternative to buying a complete PC clone.

Installation

The KCS Power PC board fits to any Amiga in minutes:

* On A500 and A500 Plus machines it simply slides into the trapdoor expansion; and doesn't invalidate your warranty!

* On bigger Amigas, such as the 1500/2000/2500/3000, it drops into a vacant Amiga slot using the custom designed adaptor board.

* Once fitted, your Amiga can be switched into PC mode simply by clicking an Icon. Just reset and it's an Amiga again.

No fuss, no hassle. Just two machines in the space of one.

Video

* Supports the majority of EGA and VGA modes in 16 glorious colours and monochrome - graphics up to 640x480 and text too. Interlace is required for some modes but a software flicker fixer is built in.

* Other video modes include MDA and CGA text and graphics. Also supports Tandy colour graphics adaptor and Hercules monochrome.

* EGA and VGA graphics can be displayed on a domestic TV or monitor. Unlike real PC's, no extra hardware is required.

Disk

* Up to four Amiga drives can be connected to your system and accessed in PC modes as 3.5" 720K or 5.25" 360K. Typical disk access is at least twice as fast as most real PC clones!

* DOS can be started from any mounted drive 5.25" or 3.5" and most Amiga hard drives.

* Supports most popular hard disks including GVP Impact, Supra and A590 (Omtl and SCSI).

* A massive 200K ramdrive (up to 8Mb with expansion) is available in PC mode and it's PC-reset proof too.

Memory

* Even with a base Amiga 704K is free for DOS programs (640K in EGA and VGA modes).

* EMS (expanded memory) is supported

"PC emulation is a contentious issue - but the KCS Power PC board is the only one to carry my personal recommendation. It is an excellent product that does all it claims and does it well."

comments Mark Smiddy, co-author of Mastering AmigaDOS 2.

PRICE

including MS-DOS and on-board memory £219.95 inc VAT/Carr
Excluding MS-DOS but incl on-board memory £189.95 inc VAT/Carr
Adaptor for 1500/2000/3000 £74.95 inc.

AVAILABLE FROM YOUR LOCAL COMPUTER SHOP

(IF NOT - ASK THEM WHY NOT) OR DIRECT FROM BITCON.

BDL

BITCON DEVICES LTD.

88 BEWICK ROAD, GATESHEAD, TYNE & WEAR,
NE8 1RS ENGLAND

TEL: (091) 490 1919, HELPLINE (091) 490 0202

FAX: (091) 490 1918



Compatibility is excellent but no-one can guarantee every single program available, therefore if your purchase depends on a particular program, please ask us first or send in a copy of the program. (With suitable S.A.E. if to be returned). Price subject to change without notice.

Australia: HPD (Tel) 08 349 8486. Kaotic (Tel) 03 879 7098. Spain: Discover Int. (Tel) 957 47 89 38.
Sweden: Delikatess-Data (Tel) 31-300580. Canary: Customs Chipx (Tel) 928 271064. Denmark: Betafon (Tel) 31 31 02 73. Portugal: Softclub (Tel) 01 352 8452. Ireland: Computer City/Dublin 745250. N. Zealand: Pzacc (Tel) 054-82949.

All trade enquiries welcome. UK and Overseas (PAL only)

WHOLLY DEVELOPED AND PRODUCED IN THE NETHERLANDS.

SOUTH Lincs PD

75p PER DISK, LARGE SELECTION OF AMIGA PD INCLUDING GAMES, GRAPHICS AND ANIMATION, UTILITIES, MUSIC, DEMOS, FRED FISH DISKS, T-BAG DISKS 1-62. BELOW IS A SMALL SELECTION OF TITLES AVAILABLE

GAMES

- 1011 Return To Earth
- 1024 Breaker
- 1040 Bionix
- 1050 Pipeline
- 1059 Tile Trial*
- 1065 Yelp
- 1086 Hugo* (3 disks)
- 1093 Downhill Challenge
- 1094 Games 12 (Air Ace 2 and more)
- 1098 MegaBall*
- 1100 Startrek T.N.G. (1.3)
- 1101 Llamatron (1.3)
- 1105 Grand Prix Sim (1.3)
- 1106 Pete's Quest
- 1110 Airmania

MUSIC AND SOUNDS

- 5037 Led Zeppelin (2 disks)
- 5066 Blues House (2 disks)
- 5067 Meaning Of Life* (2 disks)
- 5068 Walk This Way Remix
- 5074 Crystal Symphonies
- 5075 Bad Boyz* (Rave)
- 5079 Head Banger

GRAPHICS AND ANIMATION

- 2031 El Gato* (Cat Anim)
- 2040 Tron* (2 disks)
- 2069 Real Thing Birds*
- 2077 Rock Album (Slideshow)
- 2089 Madonna Cartoon* (1.3)
- 2109 Juggler II (1.5Mb)
- 2110 Juggette 2* (The Revenge)
- 2111 Anti-Lemmin (2Mb, 2 disks)
- 2113 Pogo (1.5Mb)
- 2115 Top Gun (Slideshow)
- 2120 Agatron Animation 30*
- 2124 At The Movies (1.5Mb)
- 2143 Robocop* (1.3)
- 2161 Life Of Brian

UTILITIES

- 4001 UEdit (Word Processor)
- 4070 Amibase 3.76 (Database)
- 4084 Cartoon Brushes (Clip Art)
- 4087 CManual v2.00 (4 disks)
- 4100 Text Plus 3

DEMOS

- 6059 Indianapolis 500
- 6072 Ray Of Hope 2 (1.3)
- 6073 Alpha Omega
- 6075 Odyssey (5 disks) (1.3)
- 6078 Voyage

(1.3) Amiga 1.3 only, all other titles are 1.3 and 500+ compatible. * = 1 Meg. Blank disks DD/DS, 10 for £4.80, 50 for £22, 100 for £42 (P&P inclusive) Mitsubishi Branded, 10 for £5.80, 50 for £27, 100 for £52 (P&P inclusive) Catalogue disk only 50p or send large S.A.E for list of titles. Please add 50p for postage and packing to total for orders of PD. All orders of PD sent same day by first class post. Europe add 25p per disk. ROW add 50p per disk. Cheques/postal orders made payable to SOUTH Lincs PD

10 LINDEN RISE,
BOURNE, Lincs, PE10 9TD
TEL: 0778 393470



ALL DISKS
CHECKED -
DESPATCHED
WITHIN 24
HOURS.

MCPD

ALL SINGING, ALL DANCING AMIGA P.D. SOFTWARE

Demos/Anims

- | | |
|---------------------------------|---------------------------------|
| MCD 4 Franklin the Fly ** | MCD38 Cult SFTV Guide* |
| MCD24 Gymnast Anim ** | MCD63A Anti Lemming Anim |
| MCD25 Conga Man/Windmill Anims* | MCD63B By Schwartz - Brilliant! |
| MCD28 Virtual World | MCD67 Simpsons Demo* |
| MCD29 The Boings** | MCD80 Mutley on the Bounty* |
| MCD32 Robocop Anim* | MCD81 Vietnam Conflict** |
| MCD33 Swinging Frog Anim** | MCD106 Spiderman Anim* |
| MCD37A Odyssey* | MCD108 Agatron Anim 7* |
| MCD37B Brilliant 5 Disk | MCD124 Epic Demo* |
| MCD37C SF Epic - Story Told | MCD127 Alien Breed Anim *i |
| MCD37D In 3D Anim/Demo | MCD128 Terminator 800 Demo* |
| MCD37E Form - Superbl | MCD129 My Tin Toy** |

Games

If you can't see the disk(s) you want...

- | | |
|--|--------------------------------------|
| MCG1 Holy Grail (Text) Adv ** | MCG13 Seven Tiles |
| MCG2 Breakout Const Kit | MCG15 Llamatron |
| MCG5A Star Trek TV Style | MCG19 Quick + Silva* |
| MCG5B game - very | MCG20A Star Trek the Next Gen Trivia |
| MCG5C good - needs 2 drives | MCG20B Needs 2 drives* |
| MCG6A Agatron Star Trek (Movie Trek)** | MCG30 Dragon Cave (3D)* |
| MCG6B Very good* | MCG32 Wastelands* |
| MCG9 Hollywood Trivia * | MCG36 Revenge (Mutant Camels)* |

Utilities

...just give us a call!

- | | |
|----------------------------------|------------------------------|
| MCU8 Nuke V1.4b | MCU38 D-Copy II - V Good* |
| MCU9 TCB Vector Designer | MCU40 Text Engine V3.0* |
| MCU13 Med Version 3.2 (Superb)** | MCU44 Printer Drivers (42) |
| MCU21 Sid V1.6* | MCU45 Shadow Intro Utils |
| MCU25 Slideshow Const Kit | MCU50 Messy Sid II* |
| MCU27 C-Light (Ray Trace)* | MCU57 Shadow Sample Maker* |
| MCU34 Harm Lab* | MCU59 Personal Address Book* |

Slideshows

- | | |
|----------------------------|--------------------------------|
| MCSS5 Addams Family (TV)** | MCSS19 Agatron S. Show 12 |
| MCSS6 The Prisoner | MCSS22 Roger Dean Slideshow* |
| MCSS9 Star Trek! Next Gen* | MCSS23A Terminator II S. Show* |
| MCSS10 Thunderbirds* | MCSS23B Very Good!!! |
| MCSS18 Agatron S. Show 11 | MCSS24 Creep Show* |

** DISK PRICES **

1-11 @ £1.30 each

12+ @ £1.00 each

1 FREE DISK of your choice

with every 10 ordered

• Plus compatible

Catalogue Disk £1.00

Please add 70p p&p

per order

All Prices include VAT.

Please make cheques & PO's payable to MCPD.

MCPD, 6 Colchester Road, Prittlewell, Southend-on-Sea,

Essex SS2 6HP, England. Tel: 0702 - 351941

Open from 9.30am till 6.00pm, Mon-Sat. Answerphone outside biz hrs.

NINETEEN

17 BIT, DISK 1753 (THREE DISKS)
REQUIRES TWO DRIVES

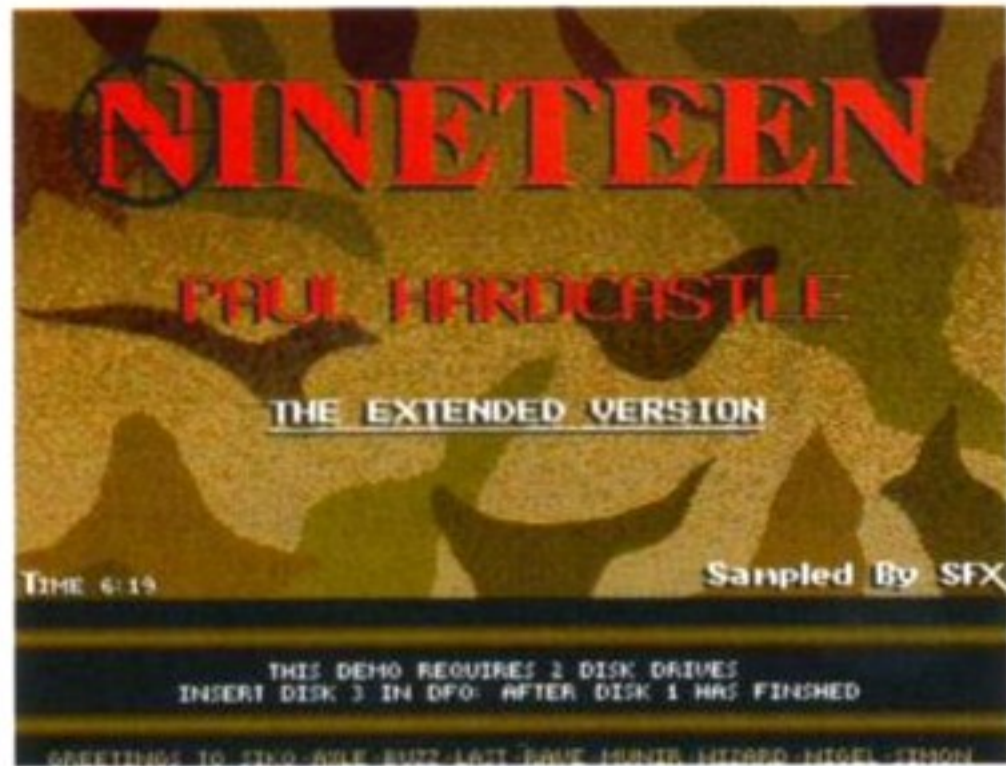

Some suitable combat imagery for a song about the Vietnam war – the classic dance track Nineteen.

If anyone can think back to the charts of the mid Eighties, they will no doubt recall the track that set the lead in using cut-up samples in club dance music; Paul Hardcastle's Nineteen. Not only did the single reach Number One in the UK, it also paved the way for the continuing trend of using samples from TV and films to add atmosphere to dance music – a trend that has been carried on right up to current rave records. But what has all this music history got to do with the PD demo world? Funny you should mention that...

Amiga musician SFX has taken a step back in time and put together a track which closely mimics the 12-inch Destruction Mix of the single. Using samples from the original track along with new instrument sounds, SFX has managed to produce a fairly accurate rendition of the track. The sample quality is pretty good, and the track slots together nicely. There is little in the way of graphics, but the screen that is displayed as the track plays has been well drawn and captures the combat atmosphere of the track's subject matter.

Unfortunately it needs to be run on a machine with an extra floppy drive, but if you want a bit of nostalgia (or are just too young to remember the record) and you do own a second drive then it is worth checking out.



Twisting shapes, cartoons, digitised pictures and more rave music than you can shake a strobe at. What can it all mean? It must be another batch of that strange phenomenon known as Public Domain software. **Maff Evans** sits down with a whole stack of disks and sorts out the choice cuts from the gristle (ugh).

CAT COMPUTER CLUB DEMO

WACK PD

If there was an award for the most relaxing demo of the month, then it would have to go to this disk. Put together by Silents and Crionics, *CAT Computer Club* features a whole host of effects, all of which unfold at a leisurely rate. All the usual elements are there, such as vector shapes, vectordots and ray-traced pictures, but all the sections have been put together with the style and care that has made Crionics and Silents big names in the PD demo world.

Most of the demos appear on a screen next to an animated silhouette of a running cat, which gives everything a sombre and mysterious feel. One of the strangest effects is the 'ghosted vectors' animation technique, which was first seen in the *Hardwired* demo. There isn't really a lot of new stuff to be seen on this latest demo, but the casual tone of the graphics and music coupled with the slick presentation make it a nice diversion for a short while. Just don't expect to be loading it up time and time again for entertainment – it's really best kept for those special, relaxing moments that are spent in private.

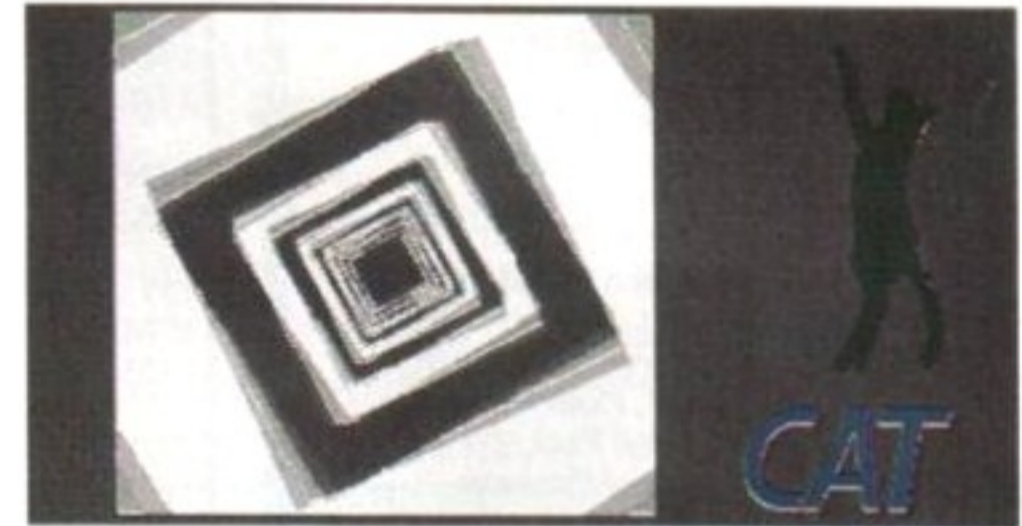

Cats and psychedelic tunnels. It's either a trip or a demo!

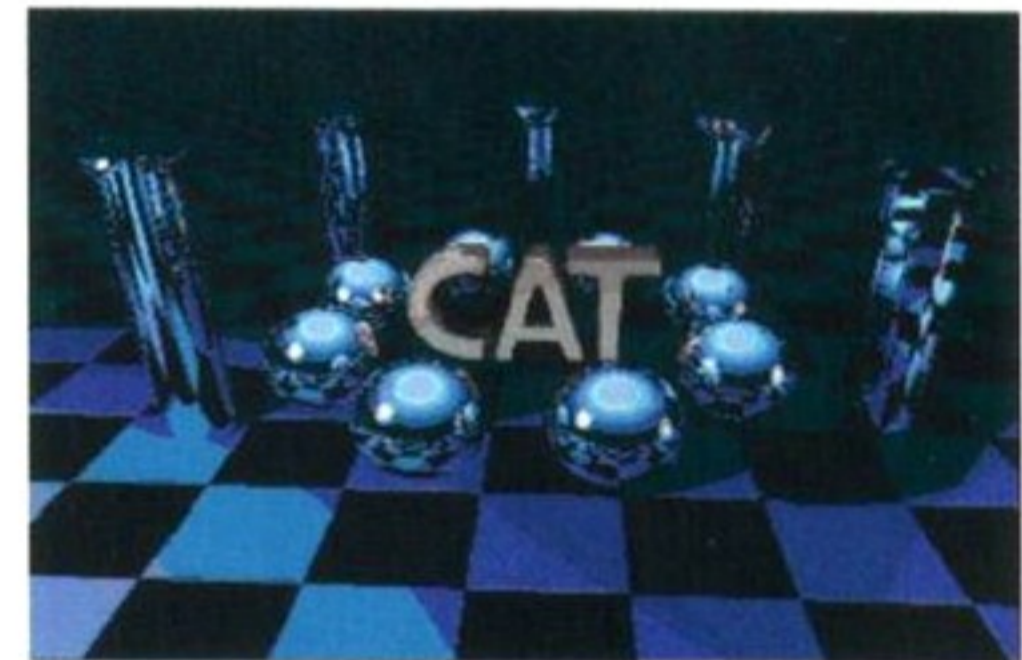

This classy image gives you some idea of the relaxing feel of Crionics' and Silents' *CAT Computer Demo*.

AMIGA FORMAT

167

JUNE 1992

TOTAL DECEPTION

WACK PD



Oh yes, very original. Colourful and smooth it may be, but it's hardly the most innovative technique ever.



Neat? Well... it looks like a tree or a lot of straggly lines, no matter what mathematical technique was used.

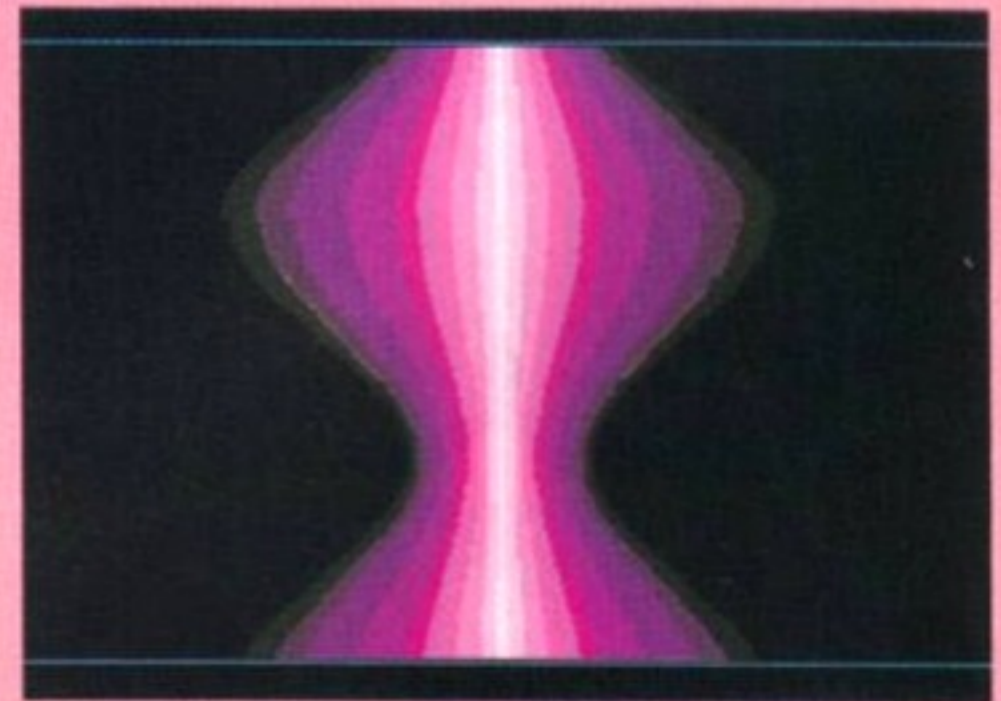

What's this wobbly tube doing here? Some more bendy lines from the *Total Deception* demo? Could be...

Judging by their very first demo, PD demo newcomers Cyborx seem to be living in a bit of a time warp. All the elements of their *Total Deception* disk are very similar to demos reminiscent of a couple of years ago. The demo starts off by displaying a couple of logos, which come complete with starry skies, silhouetted rocks and quickly follows up this cliché with some plasma effects.

Next up are some rather wibbly fractal lines to represent trees and ferns. Sorry lads, but this kind of thing has been somewhat succeeded by solid, 3D

surface fractal generators (have you not heard of *Vista Pro*? Or why not check out the *Vista 2* review on Page 148).

A Mandelbrot set, some poetry, a few vectors and copper bars and a ray-traced picture are pretty much all that's left, but these are hardly groundbreaking examples, so they are highly unlikely to hold your interest for very long at all. Even the music is a tired reworking of the usual Soundtracker theme. Liven up! This is 1992!



17 Bit Software

Quality public domain software for the Amiga
THE * MEANS NOT +COMPATIBLE

Sexy Tash says do not order pornographic disks, as we do not supply them. This has been a daz information film

PROJECT X The latest arcade smash from Team 17 available now only £17.99, with 21 PD games absolutely free. This game has received every accolade known to man, and is the ultimate blast for your Amiga on the market today. Blister those fingers now!!!
Mr Bun 100% Arcade Action.



DISK OF THE MONTH PROTRACKER 2.0 COMPLETE WITH DOCUMENTATION AND MODULES, KEN SAYS "Before Protracker 2 my life was nothing". DAZ SAYS "Nearly as good as my van." ONLY £1.10. MR BUN SAYS "Hello".

DEJA-VU

- LPD 86 N Command, needs Amos
- LPD 85 Magic Wassocks, platforms game (very playable)
- LPD 84 Quess Who, neat puzzle game
- LPD 83 Picture Hangman (good fun)
- LPD 82 Colouring Book 2 (brilliant)
- LPD 81 Pools Pro Predictor (brill)
- LPD 80 Icon Bank Editor
- LPD 79 Music Engine, (music player)
- LPD 78 Spectra, colour puzzle game
- LPD 77 Powerbase, great database
- LPD 76 Tecc Maze, puzzle game
- LPD 75 Video Lab, Titling Progs
- LPD 74 Sour Grapes, Qbert style game
- LPD 73 Database V3.0. Superb database
- LPD 72 Monster Island, Dungeon Master for the younger player
- LPD 71 Battlecars, Smash those mothers, great car game.
- LPD 70 Paint Box, Junior Paint Prog
- LPD 69 Magical Mix Up, Good Game
- LPD 68 Virus Buster, The best virus disk available today.
- LPD 67 Cyadonia, Mega Game
- LPD 66 Hotel Manager, (Monopoly)
- LPD 65 Power Planner, Home Utility
- LPD 64 Rescue 2, Better Than 1
- LPD 63 Wilberts Winter Wonderland
- LPD 62 Revolution
- LPD 61 The Final Chapter, Game
- LPD 60 Techno Snail, Platform Game
- LPD 59 Prehistoric Fun Pack
- LPD 58 Locks Keys and Enemies
- LPD 57 Kiddies Clip Art
- LPD 56 X Text, needs Amos
- LPD 55 Spritex, needs Amos
- LPD 54 Magpies Clip Art Disk 4
- LPD 53 Magpies Clip Art Disk 3
- LPD 52 LC24/200 Fonts V1.0A
- LPD 51 Magical Young Artist
- LPD 50 Magpies Clip Art Disk 2
- LPD 49 Marvin the Martian
- LPD 48 Sparx Stockin Filler
- LPD 47 Dirty Cash, Fruit Machine
- LPD 46 Magpies Clip Art Disk 1
- LPD 45 Music Box, Like Sonix, Very Nice
- LPD 44 Formula 1 Challenge V2.0
- LPD 43 Amos Lazerzone
- LPD 42 X-Stitch
- LPD 41 Rescue, Great 3D Game
- LPD 40 Sprite Bank Editor V2.0

All the above disks are professionally written programs with a fee going to the authors. All are £3.50 each. Please add 50p to all orders for P&P Thank you

STOP PRESS!!!
LOTS OF DEMO'S FROM THE RECENT ANARCHY DEMO PARTY AVAILABLE ALL LICENSED TO 17-BIT

(Please note, these demos will not be available from any other library. Tel for more details)

ORDERING DISKS

All major credit cards are taken. Opening time are
Mon - Thurs 9am - 8pm
Fri - Sat 9am - 5.30pm
Please make cheques and postal orders payable to:-
17 BIT SOFTWARE
Our address is:-
1st Floor Offices, 2/8 Market St, Wakefield WF1 1DH (Dept AF)
TELEPHONE: (0924) 366982
NOW 2 LINES
We welcome foreign orders (add 20%)

LATEST PD

- 1749 Microbes superb arcade game
- 1750 Protracker 2.0 with docs
- 1751 LSD Mega Demo, very nice
- 1752 Cascade Music Disk + only
- 1753 A.B.C. Three Disk 19 Mix from Paul Hardcastle, superb quality £3.30
- 1754 Saved Goals for Kick Off
- 1755 Star Mix Tas Copy Util
- 1756 Doly Mixture 21, intro's Comp
- 1757* The Bouncer Remix version 2
- 1758 Night Shade Music
- 1759 A.B.C.D the Bible on 4 disks (£4.40)
- 1760 Video Applications Disk 1
- 1761 As above Disk 2
- 1762 Fonts Disk
- 1763 TV Graphics Disk
- 1764 Skoda Challenge (driving game)
- 1765 Games Tamer and Joy Tester
- 1766* Tornado Slideshow
- 1767 Superb Fractal Disk, fast fun
- 1768 Disk 4 of the + Owners Utils
- 1769 Classic Utils (the cream of PD)
- 1770 Ripped Icons (over 80) to use and edit with your own programs
- 1771 Instruments disk (med, Protracker)
- 1772 A+B Final Frontier, The disk mag for Trekkies on 2 disks
- 1773* Angels Evolution Demo
- 1774 LSP RPG and Adventure Cheats
- 1775 Edword, straight from the author this text editor is mega!!!
- 1776 Lemmings Anim (1 meg)
- 1777 Viking Saga, 1 meg Anim
- 1778 Real Things Horses (1 meg, Anim)
- 1779 Brian Badlands Comic Art
- 1748 Yum Yum (game)
- 1747* Demolition Mission (game)
- 1746 Genesis Mega Demo (good stuff)
- 1745 Mad Mixers Demo
- 1744 Creepshow Slides 2 (great disk)
- 1743 Intro Maker
- 1742 Wastelands (game)
- 1741 Survivor (game)
- 1740 Noiseplayer 1.0
- 1739 Superkillers 2.2 (great virus disk)
- 1738 A+B Fractal Mountain Slideshow on 2 disks great
- 1737 Too Much 3D 1 meg anim
- 1736* Easter Island Animation (1 meg)
- 1735 Escape V2.0 (game)
- 1734 Issue 3 of + owners utils
- 1733 Issue 2 of above
- 1732 Quarix, great game
- 1731 Napalm Death Slideshow
- 1730* Airline Safety, Comic Sketch
- 1729 A + B Not the 9 o'clock News

DISK MAG CORNER AMFM 4 + SAMPLE DISK ONLY £5.00.

CONTENTS:- Vangelis discography, A500 Sound Enhancer, Roland d110 bank loader, table Midi note numbers + a selection of the latest Amiga music from Bjorn Lynn and the boys. Back issues also available. Tel for details.

NEWSFLASH 24

3 disks crammed full of the latest PD utils games and demo's from all over the world, see why Newsflash is hailed as the best disk mag in Europe. Only £6.95 for 3 Disks
U24-OUR OWN MAG AT £1.50

+ OWNERS UTILITY PACK

5 Disks crammed full of useful programs for your new Amiga+ disks are 1532, 1572, 1768, 1734, 1733, all the above disks also work on 1.2 and 1.3 as well
Only £5.50

LATEST PD

- 1728* 500 Things 2 from Nic Cusworth
- 1727* A+B Opus 2 Evolution Rush
- 1726* A.B.C. Obsession Army of Lovers
- 1725* Opus 2 Fine Day Remix
- 1724 Arcade Games Comp
- 1723 Garfield Clip Art
- 1722 Diplomacy, good strategy game
- 1721 File Locator and seeker, utils
- 1720 Superdooper, sys info 2.55
- 1719 A+B Giga Music Disk, brill
- 1718 A+B Whom 2 V2.2 Cult Info
- 1717 Bouncer Music Remix
- 1716 Parachute Jump, good game
- 1715 Terminator 2 Dance Mix
- 1714 Nightshades, Harmony
- 1713 80 DPaint Fonts
- 1712 Music of the World
- 1711* Silicon Sounds
- 1710 Classic Games, Frogger etc.
- 1709 Clipart Fonts
- 1708 Clipart Fonts
- 1707 Boot Utils
- 1706 100 DPaint Fonts
- 1705* Slideshow
- 1704 Household Inventory (home util)
- 1703 Text Plus 3, brill disk
- 1702 Boot Block Disk (lots of em)
- 1701 Amateur Radio Utils
- 1700 Amicash, brilliant util disk
- 1699 Journal, another fine util
- 1698 A + B Video Titling Disk
- 1697 Fractal Frenzy, compilation
- 1696 Alien Breed Music Remix
- 1695 Twilight Zone Remix
- 1694 Wildfire Mega Demo....

DISK PRICES
ALL DISKS £1.10 EACH
BUY 10 DISKS AND GET 1 DISK FREE!!!
BUY 25 DISKS AND GET A COMMERCIAL GAME ABSOLUTELY FREE!!
PLEASE ADD 50p TO ALL ORDERS TO HELP WITH POSTAGE AND PACKING.
All orders sent 1st class post!!!

17-BITWARE (LICENSED) DUAL CREW + COMPLEX BRING YOU FINLANDIA
A 3 DISK MUSIC DEMO OF THE HIGHEST ORDER ONLY £6.50

CRYSTAL SYMPHONIES 2 FROM PHENOMENA
A SUPERB MUSIC DISK FROM ONE OF THE BEST DEMO CREWS ONLY £1.75

The authors of both these programs receive royalty payments on every disk sold....

17-BIT SOFTWARE SPECIAL PACKS

THE ULTIMATE MUSIC CREATION PACK

1750 - Protracker 2 with docs
1572 - Med 2 superb disk
482 Games Music Creator
1614 Sample Maker
1441 Puma Tracker
ALL THE ABOVE DISKS WILL HELP YOU GET THE MOST FROM YOUR AMIGA'S POWERFUL MUSIC CAPABILITIES.
ONLY £5.50 inclusive of postage and packaging.

CLASSICAL MUSIC

1491 Mozart Flute Concertos
1487 Bach
1402 Rhapsody in Blue
1297 and 1298 Mozart Horn Concertos
878 Digital Debussy
FED UP WITH HARDCORE THEN GET A WHOLE NEW SCORE WITH THESE 5 SUPERB CLASSICAL MASTERPIECES MOST RECREATED USING SONIX FOR MORE AUTHENTICITY. AGAIN ONLY £5.50. Including all postage & packing.

SCHEME 17

- SS1 A Brimble Music
- SS2 Samples
- SS3 Samples
- SS4 Samples
- SS5 Samples
- SS6 Techno Uproar
- SS7 Make a Break
- SS8 Music Disk
- SS9 Tuff Enough
- SS10 Techno Attack 1
- SS11 Techno Attack 2
- SS12 Karaoke Disk
- SS13 Techno Attack 3
- SS14 Crystal Symphonies 2 from Phenomena

ALL THE ABOVE DISKS ARE £1.75 EACH

DISK BOXES

80 CAPACITY £5.99
100 CAPACITY £6.99

RECOMMENDED

- 1633 Gator Graphics Tutor
- 1486 Data Bases 2
- 1545 Hard Drive Utils
- 1369 Opti Utils 2
- 1208+1209 Anti Lemmin 2 meg
- 1647 Scoopex Demo
- 1281 Megaball
- 1613 Procalc 1.0

Something Fishy

- F533 DOS Manager
- F550 ICalc
- F412 JP Dir Utils
- F90 Othello
- F478 Med Songs
- F239 Mandelbrot
- F579 Octamed (latest version)
- F498 Freecopy, Tapecover
- F120 Backgammon
- F206 Picture Garden
- F578 Circuit Analysis Prog
- F355 Track Salve
- F574 Chemesthetics
- F162 Unknown Girl
- F590 Crystals
- F594 Rayshade V 3.0
- F75 Hard Copy
- F497 Centre Screen

AMAZING SOFTWARE BARGAINS AVAILABLE

AT £9.95 OR LESS

TELEPHONE FOR MORE DETAILS

BITS + BATS

MOUSE MATS £3.99
DUST COVERS £2.99
SECOND DRIVES £59.99
All Fish disks available.
All T-Bag available.
Any commercial title available.

THAT BIT BETTER THAN THE REST



WE NOW TAKE SWITCH CARDS!!!



ANALOGIC
ANALOGIC
ANALOGIC

Analogic Computers
(UK) Ltd
152 Latchmere Road
Kingston-upon-Thames
Surrey KT2 5TU
Tel/Fax: 081-541 4671
Mon-Fri 9am-7pm
Sat 9am-5.30pm
081-546 9575

COMPUTERS SPECIAL OFFERS

Amiga A500 Plus
Cartoon Classics Pack..... **1 Meg £349.95** **2 Meg £379.95**

MONITORS

Protar Visto C14M colour monitor +cable + 1 yr replacement warranty£220.00
Philips 15" TV/monitor (model 3332), remote control + scart cable£239.00
Philips 15" TV/monitor (model 2331), as above plus Teletext£269.00

ACCESSORIES

Amiga 512K RAM + clock..£24.95
Amiga Plus 512K RAM.....£34.95
Amiga Plus 1 Meg.....£54.95
Amiga/Atari Squik Mouse .£14.95
Amiga Scart Cable.....£14.95
Mouse Mat£4.95
Dust Cover.....£4.95
Super Pro Zipstick£14.95
Amiga Power Supply£44.95
10 Blank Disks.....£5.95

AMIGA A500 REPAIRS

Without diagnostic fees
★ Fixed charges ★ Fast turnaround
★ We provide pick-up service
for repairs
for only £5.00 + VAT

£49.95

★ All prices include VAT and **NEXT WEEK DAY DELIVERY** subject to availability
★ Fixed charge for repair does not include disk drive replacement nor keyboard
★ All prices subject to change without notice
★ We reserve the right to refuse any Amiga repair



BUILD YOUR OWN ROBOT

With the **NEW AMIGA INPUT/OUTPUT PORT** **£27.95**
Now you can use your Amiga to control robots, electric motors, mains appliances, anything!

- 11 Outputs. Up to 13 inputs.
- 10 page instruction manual with program listings in AMIGA BASIC, AMOS & GFA.
- FREE Technical support.
- Custom programming service.

AMAZING SENSOR & CONTROL EXPERIMENTERS KIT **£27.95** **£1 OFF** if purchased with I/O Port.
6 Electronic projects which plug into the I/O port. No soldering required. Includes relay module, motor, tilt sensor, reed switch, light bulb, 4 LEDs, powerful software on disk and **FREE "Guide to Amiga Interfacing"**.

Current projects by Switchsoft I/O Port Owners: Burglar alarm, control of model tanks, Control of a telescope, time-lapse cine camera, robotic arm. Your own imagination and creativity are the only bounds.

TEMPERATURE & LIGHT EXPERIMENTERS KIT **£11.95**
Thermo & Photo sensors which plug into the analog inputs. Software included. Print out a graph of temperature variation in your home. Save on fuel bills. The photo sensor could be used for a mobile robot (moves towards a light source).

MAINS CONTROLLER MODULE **£24.95**
Just plug in most Mains appliances. Handles 15 amps.

UNCONDITIONAL GUARANTEE.
If not completely satisfied, you may return any product within 30 days for a full refund.

Please send cheque payable to SWITCHSOFT or ring Switchsoft on 0325 464423. Prices include P&P. Overseas add £3.



SWITCHSOFT Dept AF0692
26 Ridgeway, Darlington,
Co. Durham DL3 0SF



WISHFUL THINKING

PROGRAMMERS * GRAPHIC ARTISTS * DESIGNERS

If you have the ability to produce imaginative software to an agreed timescale, Wishful Thinking would like to hear from you. We require original and creative freelance and in-house programmers and graphic artists to work on a variety of exciting projects. Commodore 64, Amiga and IBM PC formats are particularly prevalent. Applicants with experience on other home formats will also be welcomed.

Please send a **DEMO** and a covering letter to:
CLIVE THOMPSON, HEAD OF DEVELOPMENT,
WISHFUL THINKING, PO Box 10,
EGREMONT, CUMBRIA CA22 2QU

ALL DISKS
STILL ONLY
99p EACH

Anglia PD

Catalogue Disk (P)
only 70p - Includes a
superb Scenery
Generator!

(%) = Magazine review score (P) = Works on A500 and A500 Plus

DESKTOP VIDEO PACK (P) 4 DISKS £3.96
Outstanding collection for video producers. Includes Rolling Credits, Slideshow, Video Backgrounds, Special Effects, Pattern Generator and more!!!

HOME MANAGEMENT PACK 3 DISKS (P) £2.97
Calendar, Mortgage, Spreadsheet, Grammar, Mileage, World Time, Budget, Chequebook, Database, Typing Tutor, Typewriter, Grocery, List Maker, Home Banking.

CLIPART PACKS 1, 2 OR 3 EACH PACK = 5 DISKS £4.95
3 different packs of 5 disks, all full of the very best clipart for DPaint etc. (P)

FONT PACK 1 OR 2 EACH PACK = 5 DISKS £4.95
2 different packs of 5 disks. pack 1 contains: Publisher fonts, various fonts, fonts disk 2, Cosmopolitan fonts, large fonts (loads of great fonts for DPaint etc.) (P)

ANGLIA COLOUR FONTS (P) 5 DISKS £4.95
5 disks full of original colour fonts produced here at Anglia. These are 16 colour fonts - not cut and paste! They are produced in the same way as the chisel font supplied with DPaint and the Kara range of commercial fonts! They are typed straight in and work with Dpaint and TV Text.

UTILITIES PACKS 1, 2, 3 OR 4 EACH PACK = 5 DISKS £4.95
4 different packs with all the utilities you will ever need! Pack 1 contains: Chet Solace disk (26 utils), Diskmaster v3.0, Darkstar Utilities 2, 3 & 4.

EDUCATION PACK 1 (P) 5 DISKS £4.95
German, Globe, Geotime, Drawmap, Evolution, Clouds, Formula, Airfoil, Gravity Sim, Weather, Wave Maker, World Data Bank and more!! (This pack is one of our best sellers and is incredible value for money).

ASTRONOMY PACK (P) 4 DISKS £3.96
Star Chart, Amigazer, Deepsky, Gravity Well, Grav Sim, Orbit, Planet.

PRINTER USER PACK (P) 4 DISKS £3.96
Essential for all printer owners! Includes, Label Designer, Label Printer, Printer Driver Generator, Print Studio, Plus More!

FRACTALS PACK (*) (P) 4 DISKS £3.96
If you want to explore fractals then here's everything you'll need! CPlot - SMan - Mandelbrot - Polyvys - CPM - ZPlot - Fractal Lab - Mandamin - Mandelblitz - Polyvysamples - Julia - FCS - Mandelmountains

PUZZLES PACK II (*) (P) 2 DISKS £1.98
Superb new pack for fans of crossword type puzzles. Includes: Wordsearch - Reader - Wordhat - Wordgame - Crosswords - CWP - Scrazzle - Disearch

SIMULATIONS PACK (*) (P) 5 DISKS £4.95
All of the best PD simulations in one pack! Metro - Be a city planner, King Oil - you are J.R.! Nuke - Nuclear arms race, Impreium Romanum - Grab ancient Mediterranean power, Sealance - Save the world with your nuclear sub, Truckin - Run your own truckin company, DC10 - Learn to fly a DC10 jet, Lore of Conquest - Two players: take over the galaxy! Insiders Club - Superb stockmarket simulation, Air Warrior - Take you pick from a huge range of aircraft with this excellent flight simulator!

EASY BUSINESS PACK (P) 5 DISKS £4.95
All programs included are powerful but easy! Includes: Text Engine V3 (The very latest wordprocessor), Spread V1 (Spreadsheet), QBase (Simple Database), BBase II (Good Database), Bankn (Great accounts package), X-Spell (Spell checker), Print Studio, Business card maker.

INTERMEDIATE BUSINESS PACK (P) 5 DISKS £4.95
Wordwright (Wordprocessor including Mail Merge and Macros!), S-Calc (Good Spreadsheet), Amibase Pro 2 (Stunning PD Database - New!), Amiguaspell (Spell Checker), LS Label (Infinite label control), Messysid V2 (Amiga File Management + PC File Transfer), Amiga Fax (Desktop Publishing)

DISK EXPERT PACK (P) 5 DISKS £4.95
If you want to learn more about your Amiga, get this pack! - You'll be a disk expert in no time! Includes Power Packer (Easy file compacter), Sid (Brilliant CLI Replacement Tool!), Iconmania (Change any Icon in seconds), Fixdisk, Viraschecker V3.3, D-Copy (Copies, Repairs, Formats and more), CLI Tutorial (All you need to know) and 202 other utilities!!!

"C" PROGRAMMERS PACK (P) 6 DISKS £5.94
A complete "C" language and superb instruction manual provide all you need to learn the "C" language, includes North C (2 disks) and the C Manual (4 disks)

MED V3.2 MUSIC PACK (P) 4 DISKS £3.96
MED is widely recognised as the best music package, PD or otherwise!! This pack contains V3.2, the latest version complete with loads of digital samples, a disk full of MED music scores and some great MED music to load and play! Listen to what your machine is capable of!

500+ CLASSIC GAMES PACK (P) 5 DISKS £4.95
An incredible collection of superb commercial quality arcade games! Hours of fun for both kids and adults. Includes: Defender, Galaxians, Scramble, Missile Command, Pac-Man, Bi-Planes, Drip!, Space Invaders, Asteroids, Breakout, Tetris + more!

CARD + BOARD GAMES 2 (P) 4 DISKS £3.96
Another outstanding collection! 38 very good "Thinking" Games! Chess V2, Backgammon, blackbox, Towers, Pipe, Zerg, Maze, Cluedo, Connect4, Dominoes, Draughts, Othello, Go Moku, Dragon Tiles, Klondike, Canfield, Mastermind, Wordsearch, Hangman, Pontoon and many more.

HARD DISK USERS PACK 3 DISKS £2.97
Easy Backup, Mr Backup, DSD Park, Kwick Backup, Click Dos II, Fix Disk, FMS Disk, Sectorama, Disk Perf, AHDM (A hard disk menu)

Please note all pack disks may be bought singly at 99p!

SINGLE DISKS AT ONLY 99p!

BUSINESS
B303 (P) (85%) Flexibase (Good DBase with form designer)
B321 (P) (85%) Amigafox (English Desk Top Publishing)
B322 (P) (95%) 600 Business Letters (Superb! - Ready to use)
B324 (P) (75%) Q Base (The perfect database for beginners)
B314 (70%) Business Card Maker (Design Your Own)
B330 (P) (80%) Amicash (Superb new bank account manager)
B331 (P) (92%) QED (Very good wordprocessor for beginners)
B332 (P) (90%) U-Edit V2.6H (Latest and greatest word pro)
B333 (P) (86%) Amibase Professional 2 (Now PD! - Super database)
B334 (P) Appointments (never miss one! Let your Amiga remind you)
B337 (P) Findex (an easy database with good search facilities).
B339 (P) A-Graph (very easy to use - make bar + line graphs and pie charts!)

B327 (P) (86%) Text Engine V3 (great looking wordprocessor, easy yet powerful)
B340 (P) (85%) BBase II (Lightning fast database - easy and very well designed)

UTILITIES
U402 (90%) Master Virus Killer v2.1 (The best Virus Killer)
U413 (P) (100%) Sid v1.6 (makes you a master of CLI)
U416 (P) (70%) Cli Tutorial (Learn all about it)
U427 (P) Demolisher Utilities (over 200 utilities on one disk)
U437 (P) (95%) D-Copy (As good as X-Copy)
U471 X Copy III (PD version of commercial prog: Save £30!!)
U478 (P) Typing Tutor (New! Great features)
U494 (P) Pascal (2 disks - brilliant language)
U495 (97%) Viraschecker V6.00 (P) (The latest - For the plus too!)
U496 (P) (95%) Messysid V2 (Reads and writes PC disks)
U497 (P) (95%) A500+ Utilities (For the A500+ only!)
U498 (P) Turbotitle (Add subtitles to your videos!)
U499 (P) S-Movie (Smooth scrolling video titler)
U4004 (P) Pools Predictor (significantly improves your chances)
U4005 (P) (75%) Turbo Imploder (squeeze loads more onto a disk)
U4006 (P) Fancy disk label designer (the best around, in colour too!)

U4007 (P) (93%) Disk Optimiser (brilliantly simple! Any disk loads up to 15 times faster)
U4008 (P) Sid V2 (It's superb!!! Fully functional apart from Config save!)

GAMES - (*=IMEG)
G6012 (P) Backgammon (Great version of a great game)
G6013 (P) Chess Tutor (improve your skill) includes a full chess game!
G6018 (P) Dominos and Connect 4 (Good versions of the originals)
G6019 (P) A500+ Games (21 Games for the Plus!)

G6021 (P) (90%) Tanx (great fun! get it now - you won't be disappointed)
G6022 (P) Cluedo (100% accurate version of the board game)
G6023 (P) American Football Simulator (very addictive)
G6025 (P) Monopoly (excellent American plus compatible version!)

G6026 (P) Nebula (very good 3D Shoot em up!)

G677 (P) (90%) Amigoids (The best Asteroids Game)
G625 (P) Drip! (*) (You must get this classic game!)

G624 (P) Blizzard (*) (PD's best shoot em up)
G689 (P) Pom Pom Gunner V2 (Latest - New levels)

CHILDRENS
C701 (P) Learn + Play (2 disks-super education for 4-10yrs)
C704 (P) Simon Says/Space Maths
C705 Treasure Island X marks the spot - with speech!
C706 Snakes + Ladders (Classic board game fun)
C707 (P) Pair It (*) (Match the cards-great fun!)

C708 (P) Crossfire (*) (Hectic arcade game)
C709 (P) Pixie Kingdom (2 disks - save the pixies)
C712 (P) Colour Pad (New colouring book for youngsters)
C713 (P) (90%) Peters Quest (Lots of fun platform game)
C714 (94%) Storyland II (Brilliant kids game)
C715 (P) Composer (simply superb music maker for 12yrs +)
C716 (P) Snake in the Grass (great game for under 12s)
C717 (P) Frogger! (frantic frog fun for under 10s)
C718 (P) (87%) Centipede (wonderful graphics, brilliant game for ages 8 to adult!)

C719 (P) (87%) Total Concepts (2 Disks) (Astronomy & Dinosaur Education Pack - Good!)



FISH DISKS IN STOCK 350-630 ONLY 99p EACH!

DEJA-VU IN STOCK 1-85 £3.50 EACH!

PUBLIC DOMAIN SOFTWARE

ANGLIA PUBLIC DOMAIN LIBRARY
(Dept ASH), 115 Ranelagh Road, Felixstowe, Suffolk, IP11 7HU

TELEPHONE 0394 283 494

Access VISA CREDIT CARD ORDERS

Cheques + Postal Orders payable to Anglia PD

Simply phone your order through or send a cheque/postal order. Please add 60p to cover post and packing.

AMIGA FORMAT

169

JUNE 1992

FIVE-STAR PD

Over 1200 titles in stock covering FREDFISH, T-BAG all. Massive range of GAMES, DEMOS, UTILITIES, ADULT ONLY, ANIMATION and EDUCATION.

GAMES G130 Bi Planes G035 Flashbier G048 Drip G118 Mission X G124 Tetrix G121 Llamatron G012 Games Pack 12 UTILITY U022 Boot Block Util U048 Darkstar 4 U137 Uedit U180 Dlock U023 Banking U122 Sid 1.6 U176 Textplus 2.2e U09 Med 3.25	DEMO D067 Ray of Hope 2 D097 Odyssey (5d) D114 Amos Demo ANIMATION A070 Donald Duck A028 Pug in Space A156 Bruce Lee (1s) A001 Walker 1 MUSIC M040 Spank (Madonna) M097 Bad (M. Jackson) M130 David Bowie 1 EDUCATION E004 Learn and Play 1 E005 Learn and Play 2	1-9 Disks 95p each SPECIAL OFFERS 10+ Disks 80p each + FREE CATALOGUE + 1 FREE DISK NEW PLUS OWNER? PLEASE STATE FIVE STAR PD 48 Nemesia Amington Tamworth B77 4EL Tel: 0827 68496
---	--	---

Send 60p for the latest CATALOGUE + FREE BRILLIANT GAME. OVERSEAS ORDERS WELCOME. Please add 50p to all PD orders except CAT.

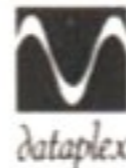

DATAPLEX COMPUTERS LTD.

129 Bath Road,
Slough,
Berkshire,
SL1 3UW
Tel: 0753 535557

19 High Street,
Old Town,
Swindon, Wilts
Tel: 0793 488448

SHOWROOM
open:
Mon - Fri
9.30 - 5.30
Saturday
9.30 - 4.30

MAILORDER
Consumables
add £2.50
Hardware
add £9.00
(courier)

Prices including VAT

AMIGA A500 PLUS (CARTOON CLASSIC PACK)

Includes new A500 Plus with 1Mb RAM, Lemmings, The Simpsons, Captain Planet, Deluxe Paint III
£330 inc VAT

AMIGA A500 (FIRST STEPS)

Amiga A500
Plus educational software
£435 inc VAT

AMIGA A1500 new version

A1500 Accounts Plus pack including Puzznick, Toki, Elf, Operating Systems Software, Home Accounts, Platinum Works, Deluxe Paint III + manual
£560 inc VAT

ADDITIONAL PACKS

Amiga A500 Plus Cartoon Classic with 10 extra games£359
A500 Basic Pack (stand alone old version) plus 10 extra games plus Photon Paint plus GFA Basic.....£295

ACCESSORIES

512K Ram + clock£35.00
1 Meg Ram + Clock£115.00
A500 Power Supply Unit£39.00
Naksha Mouse plus Operation Stealth£29.00
1Mb upgrade for A500 Plus£49.00
14" screen filter£17.00

MONITORS

Philips CM8833 MK II Colour Monitor + FREE Lead
£210 inc VAT

PRINTERS

Star LC20 Mono£135
Star LC200 Colour (9 pin)£188
Star LC24 200 (24 pin mono)£209
Star LC24 200 Colour (24 pin)£258
Panasonic KXP1124i£235
Panasonic KXP 1123£185
Citizen 120D +£125
Citizen Swift 24E + Colour Upgrade£290
Citizen Swift 9 + Colour Upgrade£195
Starjet Bubblejet Printer, SJ48£229
Canon BJ10EX£234
HP Deskjet 500 + Leads£352
HP Deskjet 500 (colour)£587
Sheetfeeder£58

All above come complete with leads

AMIGA HARD DRIVES / HARD CARD (GVP SERIES II)

FOR A1500
52Mb h/card (0-8Mb)£275
120Mb h/card (0-8Mb)£445
FOR A500
52Mb h/card (0-8Mb)£365
105Mb h/card (0-8Mb)£525

Upgrade the above with 1Mb SIMM module £39

VORTEX AT ONCE PLUS

PC Emulator for A500, A500 plus and A1500
£199 inc. VAT

AMIGA DRIVES

1 Meg 3.5" internal£55
1 Meg 3.5" external (Cumana).....£57

Disks:		Postage:
1-10	1.25	U.K. 60p
11-20	1.10	Eur. 1.50
21+	0.95	ROW 2.50

PRODISC P.D.

TELEPHONE: 021-628 1450

Phone NOW for your FREE printed catalogue

Open 24 HOURS a day 7 DAYS a week, for orders and technical help

Soundtracker Pack (not plus) 13 disks	12.00	PD ON VIDEO
Educational Pack 1 age 5+	7 disks 7.00	Prodisc PD brings you
Educational Pack 2 age 11+	8 disks 8.00	3 half hour videos:
Utilities Pack all you need	10 disks 9.50	The catalogue 3.95
Games Pack 1 (not plus)	5 disks 5.00	Eric Schwartz 4.95
Games Pack 2 30 games	10 disks 9.50	Tobias Richter 4.95

TO ORDER: Either phone for your free catalogue and then use the order form attached, or write your order on a piece of paper and send it to us, together with a cheque or postal order made payable to Prodisc PD, to the address below. Please don't forget the appropriate postage.

81 Middleton Hall Road, Kings Norton, Birmingham, B30 1AG

DELTRAX PD

DISKS FROM £1.00 FREE DELIVERY TEL: 0492 515981

OVER 1600 HIGH QUALITY TITLES TO CHOOSE FROM

() = NO OF DISKS * = NO OF MEG P = PLUS COMPATIBLE (D) = DRIVE

UTILITIES	GAMES	MUSIC AND DEMOS
U4 Jazzbench	G4 Megaball (P)	M10-39 Sample Sounds (P)
U14 Clerk v4.0 Accounts	G5 Star Trek 1 (2) (P)	M45 Protacker v1.1a (NP)
U22 Relational Database	G9 Flashbier	M49 Star Trekker 1.3 (P)
U42 Disk Salvage	G14 Holy Grail (NP)	M77 Med v3.2 (P)
U47 C Language Manual (3)	G22 Card Games (P)	M99 Classical Music
U54 Quickbench Plus (P)	G23 SuperTwintris (P)	M159 The Wall (6) 2D (P)
U57 Genealogy * (P)	G33 Whizzy's Quest * (P)	M182 Masters At Work 2 (P)
U58 Anti-Flika	G34 Return to Earth (P)	D32 Budbrain Megademo II
U59 Windows Bench (2) (P)	G35 Llamatron 512K & * (NP)	D138 Silents "Ice" (P)
U60 Messy Sid II (P)	G36 Monopoly (NP)	D283 Hypnotic Hammer 11 (NP)
U86 Journal	G39 Bug Bash (NP)	D305 Odyssey (5) (2D)
U87 Spectrum Em+ 40 games	G43 Downhill Challenge (NP)	D306 Hardwired (2)
U88 Crossword Designer	G44 Dragon Cave (P)	
U91 MCad (P)	G48 Mayhem (P)	
U95 Electrocad (P)	G49 Mechflight RPG (P)	
U96 Amibase v3.76 (P)	G53 Scum Haters (P)	
U99 Catalogue Workshop 1 (P)	G58 Sea Lance * (P)	
U100 Catalogue Workshop 2 (P)	G59 Klondike Card Game (P)	
U102 Hard Disk Utilities	G61 Survivor RPG (P)	
U103 Amateur Radio (6)	G62 Air Ace II (P)	
U104 Bankinu	G63 Adventure Solutions 1 (P)	
U106 Q Base/Spread	G64 Adventure Solutions 2 (P)	
U111 Analytical * (2) (P)	G65 Merv The Merciless (NP)	
U112 Flexibase v2.0 (P)	G66 Snakepit (P)	
U124 Business Card Maker (P)	G68 Games Cheat List v1.0 (P)	
U131 U-Edit (NP)	G70 Parachute Joust (NP)	
U132 TextPlus v3.0	G71 Crystal Caverns (P)	
U133 600 Business Letters (P)	G73 Zeus - The Game (P)	
U135 Amigafox DTP v1.1 (P)	G75 Pick-up-a-Puzzle * (P)	
U139 A64 Emulator (NP)	G76 Chainsaw Death *	
U140 Transformer v3.3 (NP) (2D)	G79 Baloonacy (P)	
U141 iBeM Emulator	G82 Black Jack - Cards (P)	
U143 ST Emulator (NP)	G84 Peters Guest (NP)	
U146 Master Virus Killer v2.2 (P)	G88 Amigaman Games Collection	
U147 PD Copy v3.0 (P)	G90 Shapes (P)	
U149 C64 Games Disk 1 (NP)	G92 Star Trek - T.N.G. * (P)	
U150 C64 Games Disk 2 (NP)	G95 Dragon Tiles (P)	
U152 Amibase Professional II v1.2		
U154 Spectra Paint v3.2		
U161 Text Engine v3.0		
U175 Golf Recorder		
U183 Hack Pack (2)		
U212 Label/Designer		
U224 Tetra Copy + game		

PRICES:	POSTAGE AND PACKING:
1-5 disks£1.50	FREE PER ORDER U.K.
6-10 disks£1.25	Europe per disk+ 25p
11+ disks£1.00	R.O.W per disk+ 50p

OVERSEAS ORDERS WELCOME. PAYMENT IN STERLING PLEASE.

Catalogue disk £1.00 or FREE with orders over 5 disks. Fredfish catalogue disk £1.00. Blank disks - please ring for current prices. Please make cheques with bank's card number/postal order payable to: DELTRAX PD

We also stock:
Fredfish 1-530
and
TBAG 1-54

DELTRAX PD, (AF)
36 BODELWYDDAN
AVENUE, OLD COLWYN,
CLWYD LL29 9NP U.K.

All disks are VIRUS
checked and
TESTED prior to
despatch.

Simple!
Ingenious!

TRACEY

Turn your mouse into a digitiser - for just £7.95!

Do you want to trace photographs and sketches into your DTP or graphics package? You need Tracey! This precision-moulded transparent puck attaches to your Amiga's mouse to give a quick visual guide of what you are tracing. Fixes to either side of the mouse for left or right handed use.

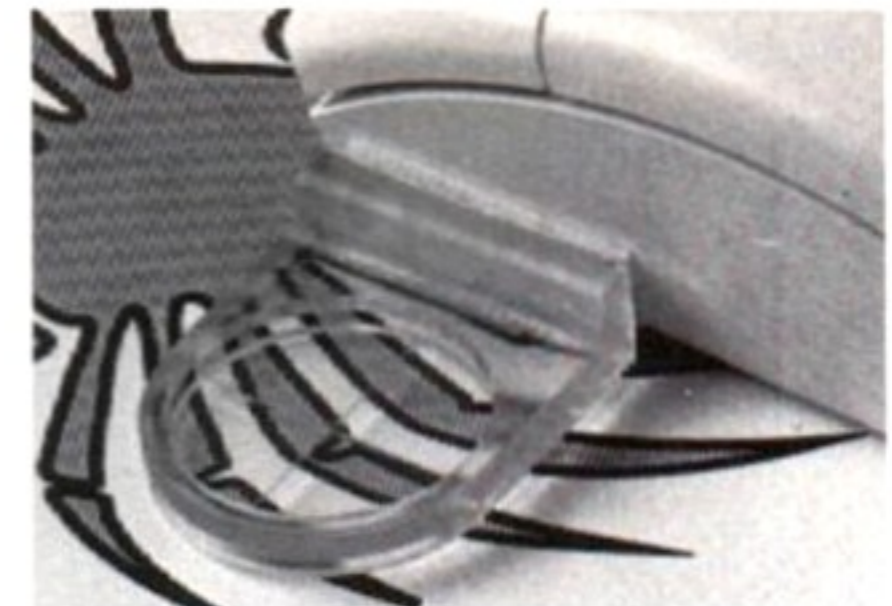

- ★ Removable when not in use
- ★ Ideal for Naksha, Commodore and all flat-sided mice
- ★ Only £7.95 including VAT and p&p

"This novel little device makes copying pictures easy" - Amiga Format, Nov. '90

"If the rule that all the simplest ideas are the best is applied, then Tracey gets the prize" - Computer Shopper, Jan '91

Cheque with order. Trade enquiries welcome.

SideWise Ltd (Dept AF35), PO Box 4,
Totnes, Devon TQ9 7EN

INTENSIVE FREQUENCY VOLUME ONE

17 BIT, DISK 1783

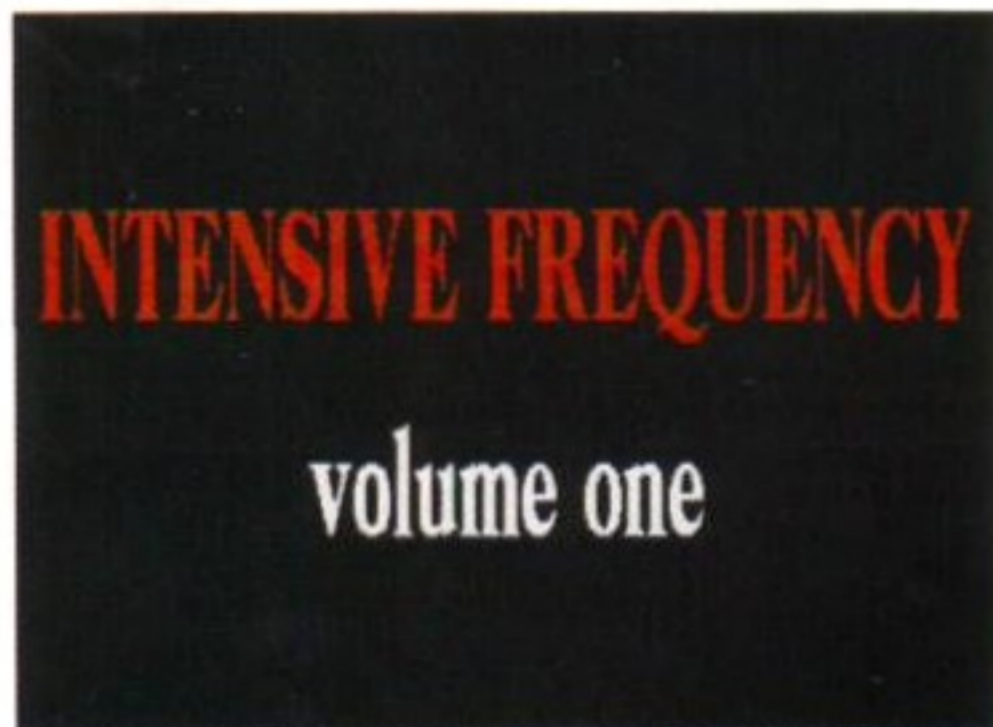

Not much in the way of impressive visuals here, but a few competent dance remixes can be found on the disk.

Not content with simply converting one hit rave track to the Amiga for their latest demo disk, Stryx and Dr Awesome have plugged in the sampler and come up with three new versions of recent chart dance singles.

First up are reworkings of Moby's 'Go' (the one with the *Twin Peaks* string line) and Altern-8's 'Activ-8'. The tracks are very similar to the originals, with the shouts, drums and synth noises all taken straight from the records and reorganised to form shorter versions.

The last track on the disk is a little more predictable - a Prodigy track. This time it's their second chart hit, 'Everybody in the Place', that gets the PD treatment. The sampling on this track isn't of as high a standard as on the other two, because it has been constructed from longer samples of the track. This means that the sample rate has to be decreased to save memory, resulting in very little difference between this version and the single, apart from the fuzziness of sound, which hardly makes for worthwhile listening.

There are no graphics on the disk, apart from a few text messages that fade in and out, and the sound quality isn't the best heard on an Amiga music demo. If you like the original tracks, chances are that you already own copies of them, so you'd be better off sitting by the stereo listening to them rather than staring at a computer screen listening to inferior versions.

GARLOWEEN THE MOVIE

17 BIT, DISKS 1800 AND 1801

There have been some odd animation demos in the past, but this has to be one of the most off-beat yet! It features... well, let's go through it a little.

It starts off with a scene from the inside of a movie theatre. The lights go down and a few adverts appear



A few cinematic adverts are always found before the main feature and the *Garloween* demo is no exception.

ALICE'S ADVENTURES IN WONDERLAND

GEORGE THOMPSON SERVICES, FOUR DISKS

This is an exceedingly strange demo. In fact it hardly seems like a demo at all. There's no music, no fancy loader, no animation and no scrolling greeting messages. So what is it? It's actually an Amiga conversion of Lewis Carroll's classic children's book *Alice's Adventures in Wonderland*.

The demo has to be loaded via Workbench, with the four disks containing text files and scans of the original line art. To view a file all you have to do is double click on its icon and the text file or picture is loaded and displayed. The text is a straight copy from the book and the scans of the illustrations have been very nicely done, but the big question has to be "What is the point?". True, it may be a classic piece of literature, but surely it's much more relaxing sitting down with the original book and reading through in sequence instead of sitting in front of a computer screen calling up short segments one at a time. If it had been a new story with a fresh approach, it may have been more interesting.

The Alice demo is a brave attempt to bring a fresh idea to the PD demo scene, but it is hardly the most exciting thing to hit the circuit. Also, when you consider that all it contains is material from a book, it's hardly original either. The approach opens an interesting avenue for future demos though. Imagine - a totally original story to be found on disk with a collection of pictures or animations at key points in the story. It could be pretty big stuff... so how about it?



To start the demo, some background information on the book and its author can be called up for educational purposes.



A disembodied head with wild eyes and a maniacal grin appears in a tree. Who else could it be but the Cheshire Cat?

on the screen, shortly followed by the trailers for forthcoming attractions. But what's the main feature? Imagine a horror flick starring a cute yellow and orange fellow by the name of Garfield and you're there, since the film is 'A Chainsaw Nightmare on Garloween Street the 13th - Part 48'. The short film carries on this ridiculous scenario, followed by credits (including a soundtrack album featuring Garf and Roses and Garchael Jackson).

The animation style is quite simple, with bold, colourful cartoon pictures to portray the scenes. Despite the fact that there isn't the detailed movement and fluid action of someone like Eric Schwartz, *Garloween* still manages to work rather well. The cleverly studied portraits and sense of humour give it a lift which makes the whole thing definitely worth watching. Order yourself a copy, put your laughing trousers on and have a giggle.



Just when you thought it was safe to go back to the post box... Garbo XI - the return of the gun-toting fuzball.

CONTACT:

GEORGE THOMPSON SERVICES:
Cucumber Hall Farm,
Essendon, Hertfordshire AL9 6JB.
Tel: 0707 664654

17 BIT: 1st Floor Offices, 2-8
Market Street, Wakefield,
West Yorkshire WF1 1DH.
Tel: 0924 366982

WACK PD: 48 Emerson Avenue,
Middlesbrough,
Cleveland TS5 7QH

TOP TEN DEMOS OF THE MONTH

Every issue we take the trouble of finding out a PD library's best-selling music and graphics demos. This month it's the turn of...

PD-SOFT

- 1 Odyssey
- 2 Hardwired (2 Drives, 1 Meg)
- 3 Flashfor Fantasy
- 4 Devil's Colours
- 5 Rhythm nation
- 6 Ray of Hope II
- 7 Digital Disco
- 8 Wildfire Mega Demo
- 9 Mangad
- 10 Skin Egg

PENTIRE PD

10a Hag Hill Lane, Taplow,
Maidenhead, Berks SL6 0JH
(0628) 666641

99p per disk. 5 or more 85p each

P&P 90p per order

European add 25p per disk

Worldwide add 50p per disk

TITLES MARKED (P) ARE ALSO COMPATIBLE WITH A500+

GAMES

G126 7 Tiles
G240 Blizzard (P)
G144 Drip
G162 Eat Mine
G138 Flaschbier
G212 Insiders Club
G125 Megaball (P)
G175 Paranoid
G139 Pipeline (P)
G106 Pom Pom Gunner (P)
G110 Puggles (P)
G169 Quick and Silva
G137 Return to Earth (P)
G142 Star Trek (2) (P)
G274 Star Trek Arcade (P)
G140 Stone Age (P)
G260 The China Shop
G229 The Holy Grail
G289 Water Mine 1
G173 Werner
G136 Wet Beaver Games (P)
G160 Wheel of Fortune (P)
G281 Wizzard World (P)
G284 Wizzy's Quest
G101 XWord Compiler (P)

UTILITIES

U358 8 Track s/tracker (P)
U312 Ami Base (P)
U225 Clerk (P)
U129 CLI Tutorial (P)
U400 D-Copy (P)
U134 Direct Action (P)
U126 Diskmaster (P)
U147 Dope Intro Maker
U117 ESA Utilities (P)
U207 Flexibase (P)
U155 Ghost Writer (P)
U424 Hack Pack (2)
U221 Hard Disk Utils. (P)
U204 Hot Stuff
U163 Icon Mania (P)
U164 Jazz Bench (P)
U236 Learn and Play (2) (P)
U224 M-Cad (P)
U255 Med (P)
U154 Messysid (P)
U434 Modern Utilities
U239 Pair-It 90 (P)
U394 QBase (P)
U227 R.I.M. (P)
U153 Slideshow Cons. (P)

DEMOS

D265 Franklyn Fly (P)
D242 Hanky Panky (P)
D130 Iraq Demo
D248 Batman Music
D182 Luxo Teenager (P)
D206 Justify My Love (1.5Mb)
D207 Rescue Me (P)
D131 Madonna III (3)
D171 Open Your Heart (P)
D257 Phenomena Enigma (P)
D175 Probe Anim. (P)
D174 Puggs in Space
D166 Robocop (P)
D190 Simpsons (P)
U252 S/T Utils (P)
D209 S/T Samples (P)
D196 Chips Are Up (P)
D230 Viz Slideshow
D300 Mr Potato Head
D301 Fillet The Fish
D187 Crionics Hardwired (2) (P)
D277 Crusaders Euro Chart
D250 Donald Duck (P)
D201 Fenntastic 3 (P)
D147 Stealth Bomber

HUMOUR

D178 Total Recount (P)
D198 Total Respray (P)
D176 Total Restyle (P)
D164 Total Retrial (P)
D275 Viz Jokes (2) (X)
D185 Dating Game (2)
A168 Delerious (2) (X) (P) (2 Drives)
D179 Eau Madonna (P)
D173 Porky Pig
G171 Lame St Ports
D258 Safe Sex (P)

GLAMOUR

A172 Bo Derek (P)
A171 Blonde Beauties (P)
A164 Sam Fox (2) (P)
A101 Girls Girls Girls (P)
A130 Girls 2
A176 Kathie Lloyd
A102 Madonna
A103 Maria Whittaker (2) (P)
A173 Sam Fox Vol 2
A160 Utopia (2) (P)
A182 Sabrina (P)

CATALOGUE DISK 75p
1000 TITLES
CONSTANTLY UPDATED

FRED FISH
AND T-BAG
COLLECTIONS STOCKED

TO ORDER GLAMOUR
PLEASE STATE
OVER 18

LOCAL CALLERS
WELCOME BY
APPOINTMENT

COOLEEN COMPUTER SERVICES

Amiga P.D.
& accessories
PHONE
MON-SAT
1pm to 9pm

30, Cooleen Ave,
Newtownards,
Co. Down
BT23 3UZ
Telephone:
(0247) 811091

Utilities

Messysid 2 (WBII)
PC Emulator needs MSdos (WBII)
QuickBench (not WBII)
WindowBench (not WBII)
JazzBench (not WBII)
SuperWorkbench
SpaceWriter
Graphics Management (2 disks)
SuperKillers (WBII)
C64 Emulator autoboot (not WBH)
Crossword Puzzle Creator
Crunchers & Copiers
PowerPacker (not WBII)
IconMania
D-Paint Fonts 2 (WBII)
Fonts & Surfaces (WBII)
Graphic Utilities
Darkstar Utilities
Virus Killer Disk
Ants Utility Disk
Printer Utilities
Print Studio (WBII)
Gelignite Fonts I (WBII)
Converters
Fractal Generator

Games

Education Pack (WBII)
Kids Paint (WBII)
Collosus text adventure
MegaBall (WBII)
WackoJR in Wonderland (not WBII)
Lazer Zone
Merv the Merciless (not WBII)
Snake Pit (not WBII)
The Maze (not WBII)
Llamatron
Chinese Checkers
Wastelands
Agony (WBII)
Games comp. 1 7 games
Games comp. 2 7 games
Games comp. 3 8 games
Games comp. 4 6 games

Music

Flash Music
Delicate Sounds
Do the Bartman remix
Keyboard Legends
Jean Michel Jarre Live:
Journey into Sound

Business

Wordwright wordprocessor
Rim database
Visicalc spreadsheet

Fred Fish & TBAG & Topik
If you have any problems using disks
please phone and we will try to help.

£1.20 per disk. Order 10 get one free. P & P 50p
ROM SHARER £29.95 2.04 ROMS £39.95 1.3 ROMS £29.95
HARD DRIVES from £299 ACCELERATORS from £350
Send cheque, P.O. or phone your Access/Visa No.

SOFT SWAP

WE BUY AND SELL ALL
TYPES OF SECOND-HAND GAMES
HUNDREDS OF TITLES IN STOCK FROM OLD TO NEW E.G.
- HEIMDALL, MICROPROSE GRAND PRIX ETC...

Phone Between
6 - 10 Weekdays
☎ 0732 872261

Write to **SOFT SWAP**
P.O. BOX 124
WEST MALLING
KENT. ME19 5RN

Cottage Industries

HOME BASED BUSINESS

EXPLOIT YOUR COMPUTER

The ART of making your computer earn.

For your FREE details send 1st class stamp to:-



COTTAGE INDUSTRIES CB
4 ODDFELLOW COURT
ODDFELLOW STREET
YSTRADGYNLAIS
SHANSEA
SA9 1LH

NEWSFLASH
8833 Mk II Monitors
Genuine UK Model
ONLY £199.95



PHILIPS TV Monitor
The best available £279 INC VAT
OR ONLY £269 when purchased
with a computer!

**LIMITED STOCKS
ORDER TODAY
AND RESERVE ONE**

DIAMOND

COMPUTER SYSTEMS LTD

DIAMOND'S SALE HAS BEEN EXTENDED TO MATCH HUGE DEMAND

1Mb RAM  **1Mb RAM**

PACK

THE FANTASTIC NEW AMIGA 600

AS SEEN IN THE COMPUTER PRESS EVERYWHERE

ONLY **£399.00** INC VAT
Or with 8833 Mk II Monitor
+F19 Promotion
ONLY **£589.00** INC VAT
COMES WITH FREE HOME MAINTENANCE ON A600

WE CANNOT BE BEATEN ON PRICE

LIMITED STOCK

1Mb RAM  **1Mb RAM**

PACK

THE EVEN MORE FANTASTIC NEW AMIGA 600 HD
WITH 20Mb HARD DISK

AS SEEN IN THE COMPUTER PRESS EVERYWHERE

ONLY **£499.00** INC VAT
Or with 8833 Mk II Monitor
+F19 Promotion
ONLY **£689.00** INC VAT
COMES WITH FREE HOME MAINTENANCE ON A600

WE CANNOT BE BEATEN ON PRICE

LIMITED STOCK

1Mb RAM  **1Mb RAM**

PACK

THE ALL NEW EVERYTHING BUT THE KITCHEN SINK PACK
NEW AMIGA 600 +5 GAMES

Teenage Mutant Turtles, Speedball II, Testdrive II, Corporation and Gunship(Helicopter Simulation)
+ All AMIGA standard features, Mouse etc.

+ Mousemat, Tailormade Dust Cover, Joystick, 10x3.5" disks, 1 disk storage box.
COMES WITH FREE MAINTENANCE ON A600

ONLY **£439.00** INC VAT
Or with 8833 Mk II Monitor
+F19 Promotion
ONLY **£629.00** INC VAT
WE CANNOT BE BEATEN ON PRICE

LIMITED STOCK

1Mb RAM  **1Mb RAM**

PACK

600 WORD PRO PACK
AMIGA 600 PLUS

With the NEW AMIGA 600 H/D with 20Mb hard disk AND 9Pin Seikosha Printer + Transwrite Word Processor + All AMIGA standard features, Mouse etc.

COMES WITH FREE HOME MAINTENANCE ON A600

ONLY **£649.00** INC VAT
Or with 8833 Mk II Monitor
+F19 Promotion
ONLY **£839.00** INC VAT
ADD £75.00 FOR COL PRINTER
WE CANNOT BE BEATEN ON PRICE

LIMITED STOCK

1Mb RAM  **1Mb RAM**

PACK

BUSINESS PACK
AMIGA 600 PLUS COMPRISING

With the NEW AMIGA 600 H/D with 20Mb hard disk + Oki 24Pin (380) Business Printer + Transwrite Word Processor + All AMIGA standard features, Mouse etc.

COMES WITH FREE HOME MAINTENANCE ON A600

ONLY **£729.00** INC VAT
Or with 8833 Mk II Monitor
+F19 Promotion
ONLY **£919.00** INC VAT
ADD £50.00 FOR COL PRINTER
WE CANNOT BE BEATEN ON PRICE

LIMITED STOCK

 **PACK**

INDUSTRY COMPATIBLE PACK
INVEST IN YOUR CHILD'S FUTURE WITH A REAL COMPUTER

A 386 Mini Tower PC running at 16MHz, 40Mb hard disk, 1Mb RAM, single 3.5" floppy drive, DOS 5, colour VGA, joystick + 6 Top Games including Risk + other War Games, Deep Space and Planet.

ONLY **£699.00** INC VAT
1 Year Warranty included
NEW PHOENIX 286 Notebook with 20Mb hard disk and 1Mb RAM
ONLY **£589.00** INC VAT

LIMITED STOCK

The NEW Adventures Of **CAPTAIN DIAMOND**



WANT A 1500
With Workbench 2.04?
GOT A 500
SWAP IT FOR ONLY £399.95
ALL PRICES INCLUDE VAT



NEW PHILIPS 15" FST TV/MONITOR,
ONLY £239
SEE TV PROMOTION ON PAGE 3
OF THIS ADVERTISEMENT!
ALL PRICES INCLUDE VAT

CAPTAIN DIAMOND'S 1500 & 3000 CENTRE

AMIGA 1500 Specials	0Mb P/X		2Mb P/X		4Mb P/X		6Mb P/X		8Mb P/X	
	£839	£669	£899	£729	£959	£789	£839	£849	£1079	£909
A1500 GVP 52Mb + 8833 Mk II Monitor	£1039	£869	£1039	£929	£1159	£989	£1039	£1049	£1279	£1109
A1500 GVP 105Mb + 8833 Mk II Monitor	£978	£808	£978	£868	£1098	£928	£978	£988	£1218	£1048
	£1178	£1008	£1238	£1068	£1298	£1128	£1178	£1358	£1418	£1248

all Mk II Monitors come with F19 Promotion

P/X = part exchange Amiga 500 For Amiga 1500

AMIGA 3000
The NEW
Commodore AMIGA 3000
25MHz processor, 100 Mb hard disk,
4Mb Fast RAM, 2Mb Chip RAM.
+ SCALA + Deluxe Paint IV,
CM 1960 M/SYNC MONITOR
£3295.00 INC VAT

ROCTEC DISK DRIVES & DISKS
UltraSlim Roclite **£54.95**
Slimline Roctec **£49.95**
CDTV Drive **£64.95**
AMIGA Internal floppy drive
Only **£39.95**
Disks only 40p

FUSION 40 68040
THE LEADER IN ACCELERATOR CARDS
WITH 4Mb ON BOARD RAM **£1299**

GVP SERIES 2 HARD DISKS
52Mb ONLY **£369.00**
105Mb ONLY **£529.00**
Perfectly matched in colour + style to the AMIGA 500p. 11ms access drive. 1" high drive by Quantum. Room for up to 8Mb of RAM expansion. Cut Off switch for games Expansion 'Mini Slot'. External SCSI port Dedicated PSU and fan. 2 years free warranty. Add **£65.00** per extra 2Mb RAM

52Mb	105Mb
Ok £369.00	Ok £529.00
2Mb £434.00	2Mb £594.00
4Mb £499.00	4Mb £659.00
6Mb £564.00	6Mb £724.00
8Mb £629.00	8Mb £789.00

ROCHARD DRIVES ALWAYS IN STOCK

HARD DISK DRIVES
FASTER DRIVES FOR LOWER PRICES.
QUANTUM IDE SCSI
52Mb **£169.95** **£179.95**
105Mb **£269.95** **279.95**
2 year warranty
SYQUEST
Removeable cartridge drive
44Mb 28ms **£299.00**
TRUMPCARD for above add **£69.95**

SPARES AND REPAIRS
Internal A500 Disk Drive **£41.95**
Fatter Agnus **£74.95**
fitted by one of our Qualified Engineers
C.I.A. chips **£14.95**
A500 fixed repair cost **£44.95**

CAPTAIN'S CHIP SHOP
4X256K DRAMS
For A590'S etc **£3.99**
1X1MB DRAMS For 8up/Supra etc **£3.99**
1x9Mb SIMMS
For NEXUS/GVP/Rochard etc **£34.99**
4x9Mb SIMMS For GVP/NEXUS etc **£159.95**
CIA CHIPS **£14.95**
1.3 ROM **£29.95**
ROM Sharer **£14.95**

These prices do not include fitting; however if you don't want to fit them yourself then this can be performed by one of our Qualified Engineers at any of our branches.

DIGITISING PACK
DIGVIEW 4
DIGITISING HITACHI CAMERA ONLY **£249**

GVP PRODUCTS FOR THE AMIGA 1500 & 2000

22MHZ ACCELERATOR
22MHz 68030 CPU
68882 25MHz maths co-pro
1Mb 32-bit RAM installed
Expands to 13Mb. SCSI HD on board controller
ONLY **£585**

33MHZ ACCELERATOR
33MHz 68030 CPU
68882 40MHz maths co-pro
4Mb 32-bit RAM installed
Expands to 16Mb. SCSI HD on board controller
ONLY **£1289**

50MHZ ACCELERATOR
FASTEST 030 AVAILABLE
50MHz 68030 CPU
68882 50MHz maths co-pro
4Mb 32-bit RAM installed
Expands to 32Mb. AT HD controller
ONLY **£1789**

IMPACT II HCS8
Wide range of drive sizes 52Mb and 105Mb options
Sockets for 8Mb RAM
Uses easy to install SIMMS
Supports virtual any SCSI device

52Mb version **£295**
105Mb version **£425**

150Mb STREAMER
Over 6Mb per min. backup Comes with GVP TapeStore software Mounts in the 5.25" drive bay Optional external casing Includes 1 DC150 cartridge
ONLY **£739**

IMPACT VISION 24
768X576 PAL resolution Supports composite video, S-VHS and RGB signals Broadcast quality genlock Software included
ONLY **£1785**

MONITORS
PANASONIC M/sync **£275**
High Res 21" colour **£1599**
8833 MK II + F19 Promotion UK
Genuine Model ONLY **£199.95**

AMIGA 1500
With Workbench 2.04

Software with the machine comprises Deluxe Paint III, The Works, Home Accounts, 3 Games (Puzznic, Toki and Elf), and a book entitled "Get The Most Out Of Your AMIGA"
ONLY **£549**

Or with 8833 Mk II Monitor + F19 Promotion ONLY **£769**

Or with NO SOFTWARE ONLY **£499**

Or WITH MONITOR NO S/W ONLY **£719**

SUPRA 8Mb BOARD FOR 1500/2000

Bareboard	£89		
Add	£69 for 2Mb	Add £138 for 4Mb	
Add	£207 for 6Mb	Add £275 for 8Mb	

NEXUS BOARD
Bareboard 0Mb HD 0k RAM ONLY **£149**

RAM	0Mb	2Mb	4Mb	6Mb	8Mb
No HD	£149	£199	£249	£299	£349
52Mb HD	£299	£349	£399	£449	£499
105Mb HD	£399	£449	£499	£549	£599

GENLOCKS

Rocgen	£89.95
Rocgen +	£124.95
Rendale 8802	£119.95
G2	£575.00
G2+	£999.00
Video Pilot	£999.00
New Philips Editing System Only	£399.00



THE DIAMOND PRICE PLEDGE

If, whilst buying goods from us, you can show us a better price on the same goods from one of our U.K. competitors then Diamond will match that price.

Even if our prices have increased, we will honour the prices in this advertisement on items in stock.

This PLEDGE applies only to customers producing or relying on this advertisement before the end of the month of publication. It does not apply to competitors prices offered in closing down or stock clearance sales.

Join in the special Diamond & Philips promotion to launch our new retail shops

ULTIMATE SOUND & VISION



First branch opens this June in the basement of our London Branch at 232 Tottenham Court Road

Save up to £30.00

on a Philips TV when you pop into Diamond
and pick up a bargain today by using Diamonds two ultimate saving plans

Philips Televisions

Normal RRP

Cube Teletext TV 14" £279.99

Cube Teletext TV 17" £329.00

The new Book TV £249.99

FST TV 15" £239.00

SAVING PLAN 1

Save £10 on RRP if purchased with
the new Amiga 600,
includes connecting leads.

Come and see the TV & Hi/Fi
specialists at
ULTIMATE SOUND & VISION

To celebrate our opening, anyone visiting our Tottenham Court Road
branch on May 30th can enter a FREE draw to win a 21" colour TV.
No purchase necessary, just fill in this form & hand it in at the shop.

Name.....

Address.....

.....TEL.....

£20

SAVING PLAN 2

OFF

VOUCHER
When you make any
purchase over £200
from any branch of
Ultimate Sound &
Vision. End 31st July

HITACHI
CCTV CAMERA
ONLY 129.95

P/X Your old 500
for a new Amiga 1500
for ONLY £379.95
WITH WORKBENCH 2.04



PART EXCHANGE EX DEMO
AMIGA 500
+3 MONTH'S WARRANTY
ONLY £199.95

DISKS
ONLY
40P EACH

CAPTAIN DIAMOND'S PERIPHERALS PAGE

ALL PRICES INCLUDE VAT

APPLICATION SOFTWARE

Graphics & General		20th Century	
Advantage	£64.99	Spelling	£7.69
Anim Font 1 or 2 or 5	£19.59	World Geography	£7.69
Art Dept	£52.29	General Science	£7.69
Art Dept. Pro 2	£139.99	Compedium 6	£26.99
Big Alternative Scroller	£34.99	Distant Suns 4.0	£27.49
Broadcast Titler 2	£154.99	Fun School Series	£15.99
Colourburst	£449.99	French Mistress	£15.49
Deluxe Paint IV	£54.99	GB Route Plus	£54.99
Digiview Media Station	£109.00	Mavis Beacon Typing	£22.99
Disney Animation Stud	£64.99	Micro Series	£16.99
Flow 3.0	£59.99	Tekno Amiga	£69.99
Font Grabber	£29.99	Yale Bright Star	£11.49
Imagine 2	£194.99	DTP & Wordprocessing	
Kara Fonts 1	£53.49	Excellence 2	£59.99
Kara Fonts 2	£47.79	Final Copy	£59.99
Kara Fonts Sub Headline	£27.49	Gold Disk Decorate or Design	
Mediastation	£119.95	or Publish	£23.49
Personal Finance Mgr	£19.99	Gold Disk Video	£30.50
Personal Font Maker	£34.99	Kindwords	£29.99
Pixel 3D	£64.95	Pagesetter 2	£39.99
Presentation Master	£149.99	Pagestream 2.2	£129.99
Pro draw	£78.49	Pen Pal	£54.99
Prodraw 2	£89.99	Personal Write	£19.99
Professional Calc	£129.99	Protext 5.5	£99.99
Pro Video Post	£117.60	Pro Page 2.1	£169.99
Real 3D Beginners	£99.99	Pro Page 3.0	£149.00
Scenery Animation	£49.99	Quickwrite	£29.99
Spectra Colour	£39.99	Scribble	£24.95
Take 2	£79.95	Structured Clip Art	£23.50
TV Text	£34.29	Transwrite	£29.99
Video Director	£99.99	Wordsworth 1.1	£89.99
Vidi Amiga	£84.99	Works Platinum	£49.99
Vidi Complete Clr Sol	£129.00	Development & Utilities	
Vidi Colour Solution	£139.99	AMOS or Easy AMOS	£29.99
Vistra Pro	£49.99	AMOS 3D	£22.99
Music & Sound		AMOS Compiler	£19.99
AMAS 2	£69.95	Anim Fonts 1,2 & 3	£29.99
Audio Engineer +2	£149.99	Blitz Basic	£69.99
Audiomaster 4	£44.28	Can Do V1.6	£64.99
Audition 4	£34.99	Cross Dos	£22.99
Bars & Pipes Pro	£156.89	Dev Pac 3.0	£49.99
Deluxe Music const Set	£49.99	Directory Opus	£25.99
Dr T Copiest Apprentice	£58.85	Diskmaster	£32.99
Dr T KC5 Level II V3	£147.09	Hi Speed Pascal	£64.99
Jam	£69.99	Home Accounts 2	£36.99
Music X 1.1	£69.95	Hyperbook	£42.99
Perfect Sound	£39.95	Lattice C V5.1 dev sys	£171.19
Stereo Master	£29.99	Quarterback	£39.99
Sound Master	£84.99	Quarterback Tools	£44.99
Techno Sound Turbo	£29.99	SAS C	£159.99
Educational		Superback	£35.99
Answer Back Jnr	£15.25	Superbase Pro 4	£299.00
Answer Back Snr	£15.25	Superbase Pers 2	£76.49
Answer Back Data Disks		X Copy	£30.39
Arithmetic	£7.69		

DOT MATRIX PRINTERS

Printer	Price	Printer	Price
STAR LC20	£116.32	CANON BJ10EX	£217.37
CITIZEN 124/D	£179.77	CANON BJ300	£349.95
STAR LC 24/10	£158.62	STAR SJ48	£210.32
STAR LC 200	£169.20		
STAR LC 24/200 COL	£233.82		
SWIFT 9 COLOUR	£179.77		
SWIFT 9	£170.37		
NEW SWIFT 24E COL	£270.25		
XB 24 200 COL	£348.97		
XB 24 250 COL	£417.12		

COME AND SEE THE NEW COLOUR
PANASONIC PRINTER £119.95
NEW SP2400 SEIKOSHA £139.82
PANASONIC KXP 1123 £159.80
OKI 380 £199.75
SWIFT 9X £259.95
SWIFT 24X £379.52
NEW SWIFT 224 £229.12
NEW SWIFT 224 COL £239.70
NEW SEIKOSHA 24 PIN £245.57

INK JET PRINTERS

Printer	Price	Printer	Price
HP PAINTJET	P.O.A.		
HP DESKJET	£327.82		
HP DESKJET COL	£527.57		

LASER PRINTERS

OKI 400	£551.07
HP III P	£809.57
OKI LASER 800 0.5Mb	£999.92
OKI LASER 800 Dual bin 0.5Mb	£1199.67
OKI LASER 830 Postscript 2Mb	£1099.80
OKI LASER 840 Postscript 2Mb	£1399.42

STAR BUY
OKI 400
1.5MB RAM
ADOBE
TYPE
MANAGER
£699.95

TOP 30 GAMES SOFTWARE

Formula 1 Grand Prix	£20.89	Football	
A320 Airbus	£21.59	Crazy Challenge	£16.89
Jimmy White's		PGA Tour +	£19.49
Whirlwind Snooker	£17.99	Alien Breed	£16.24
WWF Wrestlemania	£15.59	Monkey Island	£19.49
Harlequin	£15.59	First Samurai	£20.14
Birds Of Prey	£20.99	2 Hot 2 Handle	£19.49
Robocop 3	£15.59	Lotus Turbo	
Dizzy Collection	£14.99	Challenge 2	£16.89
Populous 2	£17.99	Soccer Stars	
World Series Cricket	£17.99	Compilation	£16.89
Ultima VI	£20.14	Knights Of The Sky	£22.74
Another World	£16.89	Heimdall	£22.74
Abandoned Places	£19.49	Leander	£16.89
Castles	£19.49	Ninja Collection	£12.99
Terminator 2	£16.89	The Jetsons	£8.44
Oh No!		Board Genius	£19.49
More Lemmings	£12.99		

PERSONAL CALLERS ONLY FOR GAMES SOFTWARE NOT AVAILABLE ON MAIL ORDER
CLUB MEMBER PRICE ONLY

LET CAPTAIN DIAMOND PUT YOU IN THE CLUB FOR ONLY £10

DIAMOND SHOPS AROUND THE U.K.

DIAMOND COMPUTERS 144 FERRY ROAD EDINBURGH TEL: 031 554 3557 FAX: 031 554 3557	DIAMOND COMPUTERS 232 TOTTENHAM COURT ROAD LONDON - W1 TEL: 071 580 4355 FAX: 071 580 4399	DIAMOND COMPUTERS (HEAD OFFICE) 84 LODGE ROAD SOUTHAMPTON TEL: 0703 232777 FAX: 0703 232679
DIAMOND COMPUTERS 1022 STOCKPORT ROAD MANCHESTER TEL: 061 257 3999 FAX: 061 257 3997	DIAMOND COMPUTERS 406 ASHLEY ROAD POOLE - DORSET TEL: 0202 716226 FAX: 0202 716160	CORPORATE SALES TEL 0703 333184 FAX 0703 232679
DIAMOND COMPUTERS 1045 HIGH ROAD CHADWELL HEATH ROMFORD TEL: 081 597 8851 FAX: 081 590 8959	DIAMOND COMPUTERS 443 GLOUCESTER ROAD BRISTOL TEL: 0272 522044 FAX: 0272 521738	CONTACTS: SHARON/DAWN/BARBARA EDUCATION/GOVERNMENT ORDERS ACCEPTED 14 DAYS ADD 2% 30 DAYS ADD 5%

HOW TO ORDER

Simply telephone through your order, giving your Access or Visa card number, or send a cheque or postal order to your Local Dealer. MAIL ORDER No. 071 580 4355
Prices include VAT unless otherwise stated. Minimum Courier Service £10.00
Allow 10 working days for cheque clearance. Bankers drafts clear on the same day.
All prices are correct at time of going to press but may change without notice.

POSTAL SERVICE FROM OUR TOTTENHAM COURT ROAD BRANCH ONLY

THE DIAMOND PRICE PLEDGE

If, whilst buying goods from us, you can show us a better price for the same goods in stock from one of our U.K. competitors then we will match that price

Even if our prices have increased we will honour the price in this advertisement on items in stock as long as you bring it with you

This Pledge applies only to customers relying on this advertisement before the end of the month of publication. It does not apply to competitors prices offered in closing down or stock clearance sales.

Answering questions for fun and profit! here, for the first time, we are proud to present the grand Amiga Format quiz:

a bunch of ludicrously irrelevant questions which you should be able to have some fun answering. But there's

also gain to be made: you could be one of five lucky winners to go home clutching a brand-new A570 CD-ROM drive, as supplied to us by this month's competition sponsors, Calculus.



The Grand Amiga Format Win an A570 CD

Brought to you by...

This is the first example of what (we hope!) will become a regular feature of **Amiga Format**: the Grand Quiz. It's partly for fun, and hopefully you should get a bit of fun out of answering the questions: but if you don't like playing the game for its own sake, you can also enter the draw for your chance to share in a massive-prize giveaway!

This month we've got five – count 'em! – brand-new, Commodore A570 CD-ROM drives to give away. The prizes have kindly been supplied by Calculus, a name you should expect to see more of in your area in the very near future.

In case you're not familiar with the name, Calculus is a nationwide network of local Amiga dealers, linked together by a central telephone system. This means you can telephone the central number, find out where your local Calculus store is and be assured that you'll be able to pop round and purchase a wide range of Amiga goodies at the Calculus fixed price. Using their computer system, the telephone service can even tell you whether a particular item is in stock at your local Calculus shop!

Because the Calculus network is made up of independent, local stores, they are firmly committed to bringing you a friendly, personal and knowledgeable service, which is always a great boon. Features of the Calculus network currently include:

- Over 150 stores and growing fast
- Based throughout the UK
- Database telephone number connects to a computer system providing local dealers' names, addresses and telephone numbers
- The UK's largest volume mover of Amiga professional products
- Exclusive A3000 trade-in offer authorised by Commodore
- About to launch a national PC advertising campaign in major national newspapers.

HOW TO ENTER

Simply write down the answers to all ten questions on the back of a postcard or stuck-down envelope along with your name and address, then send it to Grand Quiz June, *Amiga Format*, 29 Monmouth Street Bath BA1 2DL to reach us by the closing date of June 12. You can enter as many times as you like provided that each entry is posted separately. Please do not include entries with any other correspondence to the magazine: the competition address is different from our normal correspondence address.

THE RULES

Employees of Future Publishing, ZCL PLC and Calculus member stores are not allowed to enter. Entries will be drawn from the postbag after the date of closing and the first five correct entries drawn will win. The judges' decision is final and no correspondence will be entered into. No cash or other alternative prizes will be offered but we reserve the right to offer prizes of an equivalent value if the prizes named are unavailable.



at Quiz for June ROM drive

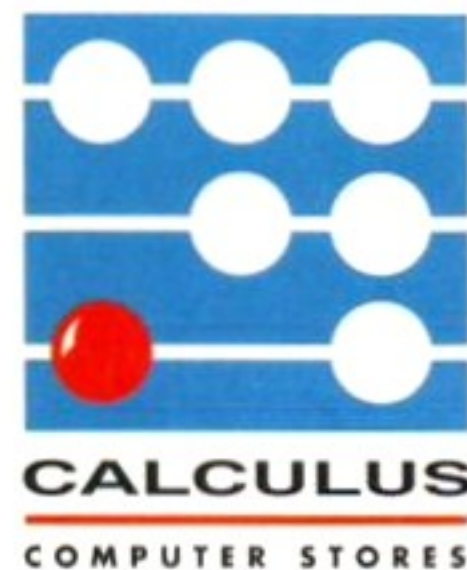

A570: going for a drive!

Right, there's 10 questions here, and what we want, of course, are the answers. Because the A570 is a drive and because its carefully-chosen name sounds more like a road number than anything else, we thought the theme for this month's quiz should be a short trip through Lancashire along the A570 and a few others

- 1** The A570 has (T) after its name on maps: what does that mean?
- 2** Racehorse trainer Ginger McKane used Southport beach as running ground for which three-times Grand National winner?
- 3** St Helens is home of glass-makers Pilkington: what's their winning connection with the game of rugby?
- 4** What formative railway experience took place at Rainhill, just between St Helens and Liverpool?
- 5** For what is the old estate of Lord Derby at Knowsley, just west of St Helens, best known?
- 6** Which was the first motorway built in Britain?
- 7** Which is the longest road bridge in the UK?
- 8** England's less glamorous equivalent of Route 66 is the A66: where is it?
- 9** Where is the longest road tunnel in the world?
- 10** Which two Roman roads, still followed by modern A roads, meet at Lincoln?

probing road-related questions. What a bunch of train-spotters, eh?

Basic info: the A570 runs from Southport to St Helens via Ormskirk, which is just north of Liverpool for the uninitiated. Now answer these incredibly silly questions — you may use reference books or ask clever people, if you need to!

Swap your April Amiga Format VISTA cover disk and upgrade to VISTAPRO 2

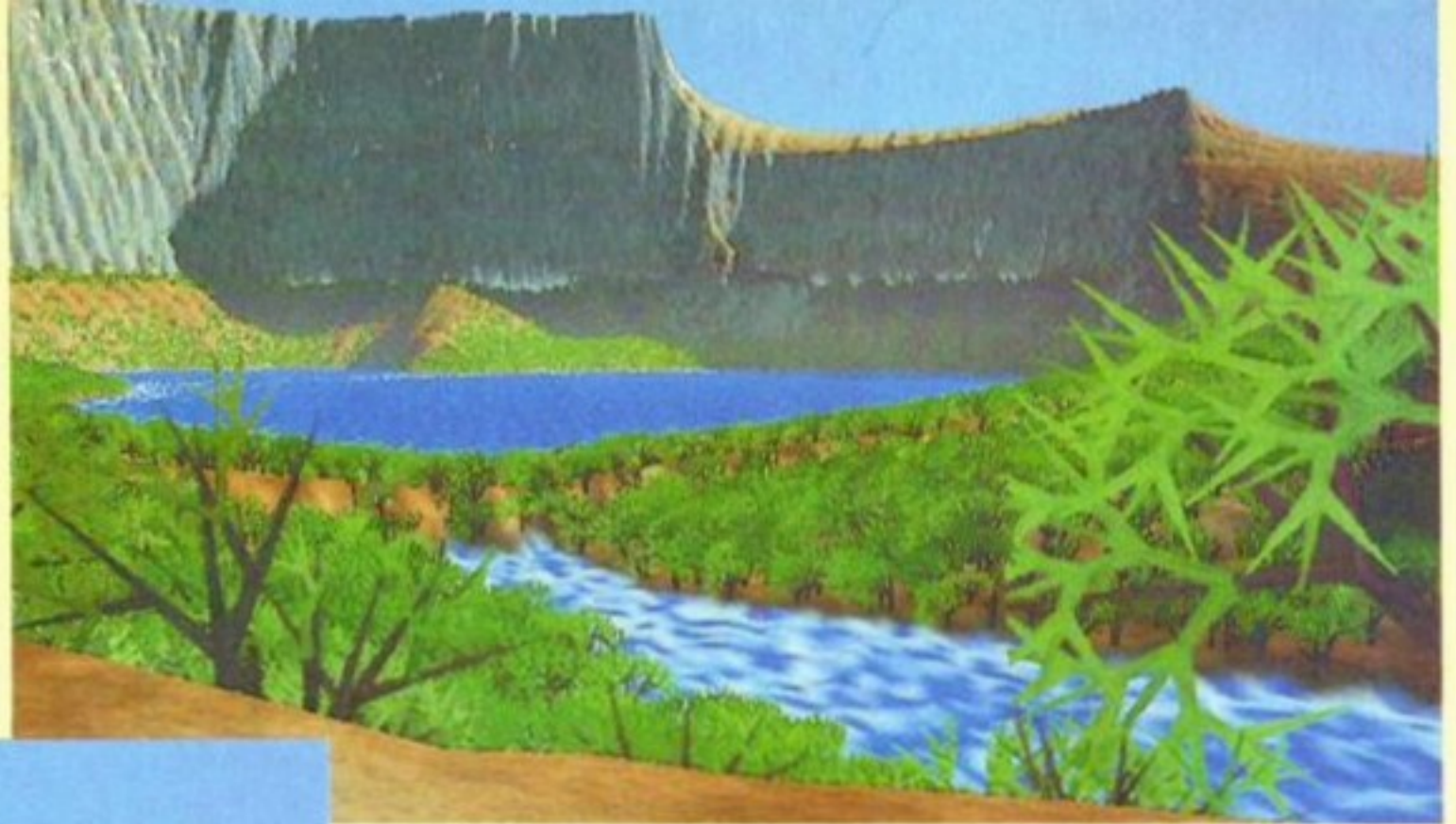

£39.95

NORMAL PRICE £69.95

VISTAPRO 2.0 OFFERS

- The most complete final image control of any landscape simulator
- Add oak, pine, palm, cactus, sage brush trees in varying mixes and density.
- Add large or small buildings, roads and sunsets.
- Direct support for DCTV, FireCracker, HAM-E and ARREX

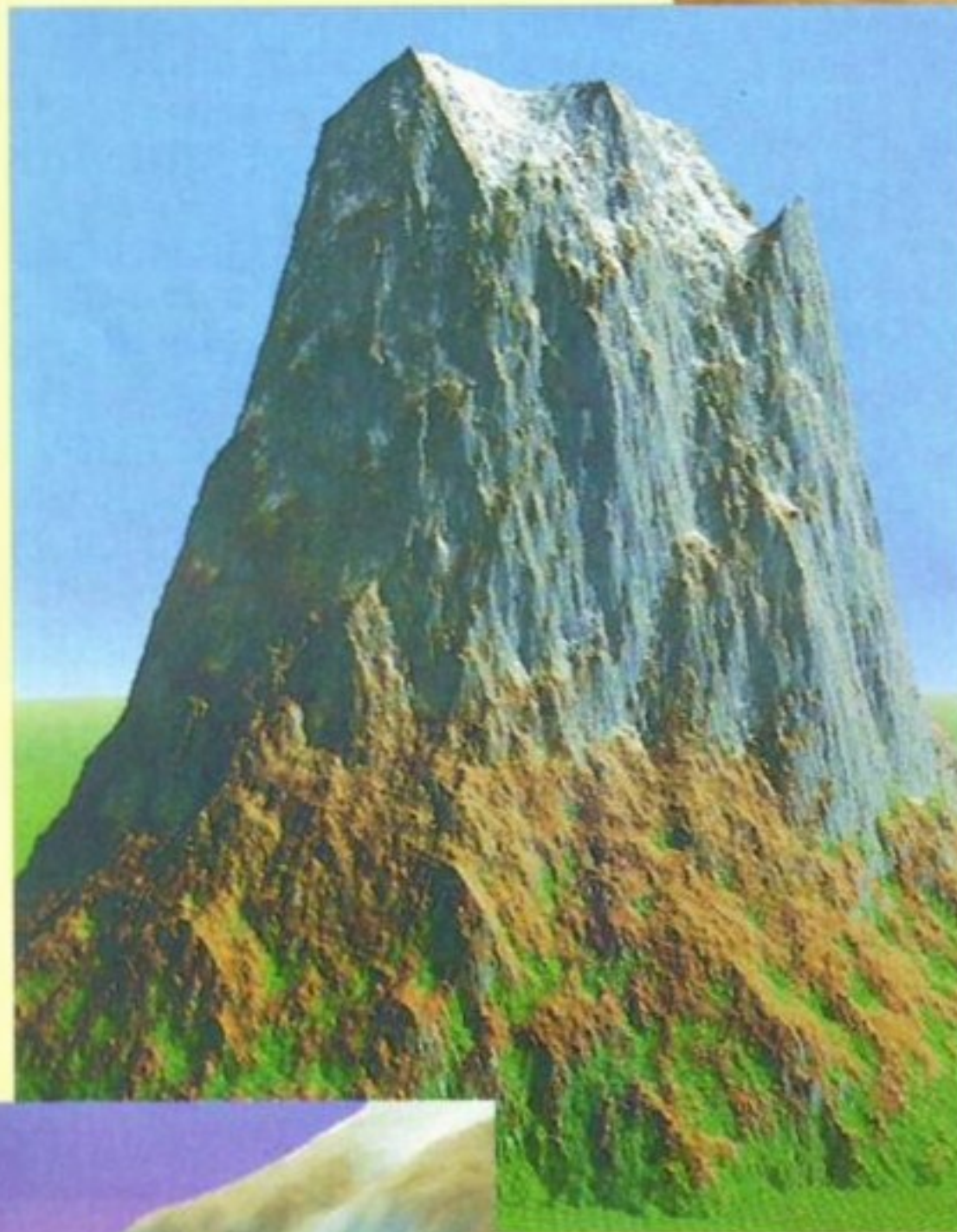

Other packages that can be purchased under the special Amiga Format VISTA cover disk offer are:

TERRAFORM - modify your VISTA and VistPro landscapes or create your own. Add dams to rivers, run roads up mountains, flatten or build up mountains, make craters etc. **£29.95**

MAKEPATH - a motion editing tool. Create complex animation sequences, control acceleration, banking and pitch. Works with both VISTA and VistaPro images. **£29.95**

Scenery Disk X001 - part of Mars equatorial region, Valles Marineris, Pavonis Mons, Acraeus Mons, Tharsis Tholus, Lunae Planum, Syria Planum, Sinai Planum **£19.95**

36 different scenery disk sets of various locations in the USA including Grand Canyon. Ask for list with order

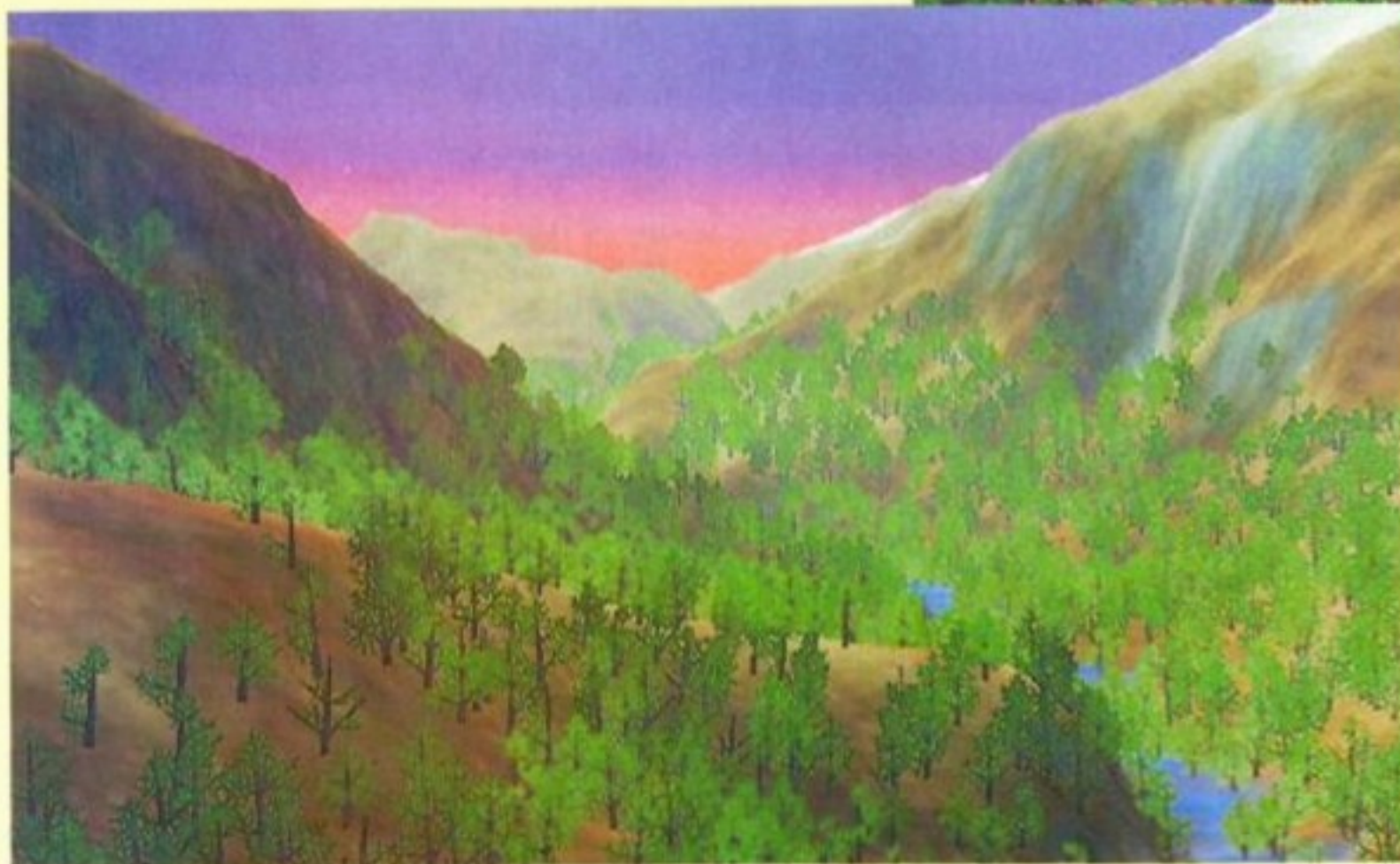

VISTAPRO 2 now supports user definable backgrounds and foregrounds. For instance a foreground might be a shot from inside a light plane cockpit looking out of the window. A background might be a particularly nice cloud photo or astronomically-correct night sky rendered with Distant Suns 4.0

NOTE: VISTAPRO 2 needs 3mB or more. If you own an accelerator card VISTAPRO 2 will take advantage of it.

Cheques to be made payable to:
Genisoft Ltd

Unit 3, Poyle 14, Newlands Drive, Colnbrook, Slough, Berks., SL3 0DX

ACCESS and VISA accepted - 48 hour despatch (cheques 7 days). Overseas customers add £2.50 postage. ALL prices include VAT.

Remember - you **MUST** include your free VISTA cover disk from the April issue Amiga Format

Original Virtual Reality Labs. VISTA Manual for your Amiga Format April Cover disk **£4.95**

NOTE: To take advantage of these update offers, you **MUST** send in your April Amiga Format VISTA diskette and £1-00 post/package with your order (your diskette will be returned with your order).

VISTAPRO 2 control panel

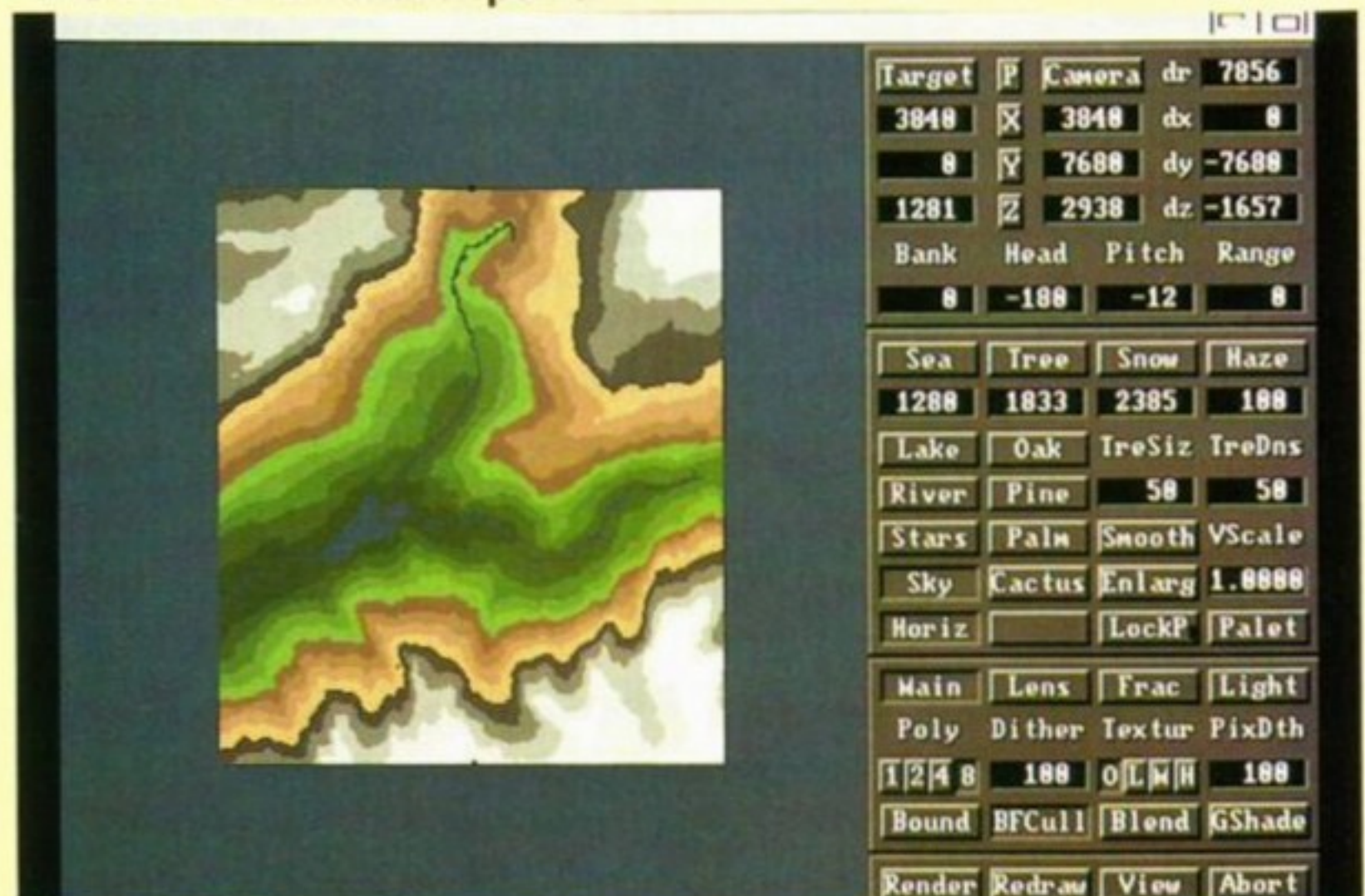

You missed the April issue of Amiga FORMAT - DON'T WORRY
Send this coupon to Amiga Format Back Issues, Future Publishing,
The Old Barn, Somerton, Somerset, TA11 7PY. Fill in your name
and address and enclose a cheque or PO for £5 made out to Future
Publishing Ltd. Order code: HB04

Name: _____
Address: _____

Price Busters!!

Graphics & General

Advantage	64.99
Art Department Pro 2....	139.99
Big Alternative Scroller ...	34.99
Broadcast Titler 2.....	154.99
Colourburst	399.99
Deluxe Paint IV	54.99
Disney Animation Studio..	64.99
Flow 3.0	59.99
Font Grabber - NEW!!.....	29.99
Imagine 2.0 - NEW!!	194.99
Mediastation.....	119.95
Personal Finance Manager	19.99
Personal Font Maker	34.99
Presentation Master	149.99
ProDraw 2.0.....	89.99
Professional Calc.....	129.99
Real 3D Beginners	99.99
Scala.....	179.99
Scala 500.....	69.99
Scenery Animator	49.99
Take 2	64.99
Video Director	99.99
Vidi Amiga.....	84.99
Vidi Colour Solution	139.99
Vista Pro 2	49.95

Educational

Compendium 6	26.99
Distant Suns 4.0	49.99
Fun School 4 Series	15.99
GB Route Plus.....	54.99
Micro Series.....	16.99
Tekno Amiga.....	69.99

Development & Utilities

AMOS	29.99
AMOS 3D	22.99
AMOS Compiler.....	19.99
Easy AMOS	22.99
Anim Fonts 1, 2 & 3	29.99
Blitz Basic	59.99
Can Do V1.6	64.99
Cross Dos.....	22.99
Dev Pac 3.0	49.99
Directory Opus.....	25.95
Diskmaster.....	32.99
HiSpeed Pascal	64.99
Home Accounts 2	36.95
Quarterback.....	39.99
Quarterback Tools	44.99
SAS C.....	159.95
Turbo Print Pro	39.99

Hardware

A1500 Accessories	CALL
A1500/2000 40Mb	
Quantum Hard Card.....	299.99
Mouse/Joystick Switch....	14.99
Boot Selector Switch.....	14.99
512K RAM with clock	29.99
1.5Mb RAM with clock	82.99
Colour Handy Scanner..	279.99
Dual Serial Board.....	159.99
Invision Plus/Live	499.99
Kickstart Switch.....	16.99
Naksha Handy Scanner ..	89.99
Naksha Mouse	22.99
Optical Mouse	29.99
RGB Splitter	59.99
RocGen Genlock.....	84.99
RocGen Plus.....	129.99
Podscat Graphics	
Tablet	189.99
Touch Screen for Amiga.....	229.99
3 Button Track Ball.....	34.99
Zydec Trackball.....	29.99
Zydec Amiga Drive.....	49.99
Zydec A500 1Mb RAM Card	44.99
Zydec Hand Scanner	119.99

Music & Sound

AD1012/Studio 16 Card - NEW!	429.99
AMAS 2.....	69.95
Audio Engineer Plus 2 ..	149.99
Audition 4	34.99
Deluxe Music Const. Set.....	49.99
Jam - NEW!!.....	69.95
Music X 1.1	69.95
Perfect Sound	39.99
Stereo Master	29.99
Soundmaster.....	84.99
Techno Sound Turbo.....	29.99

DTP & Wordprocessing

Excellence 2.0.....	59.99
Final Copy.....	59.99
Kindwords	29.99
Page Setter 2	34.99
Page Stream 2.2	129.99
Pen Pal	54.99
Personal Write	19.99
Protex V5.5	99.99
Professional Page 3.0 NEW!.....	129.99
Quickwrite	29.99
Scribble	24.95
Transwrite	29.99
Wordworth 1.1.....	89.99
Works Platinum.....	49.99

FREEPOST or £5 Securicor

48 hour despatch (cheques 7 days)

Cheques should be made payable to Softstore
Access and VISA cards accepted

Softstore, 410 Bath Road, Slough SL1 6JA

0628 - 668320

CALLERS WELCOME

FOOTBALL TACTICIAN

Until now, football simulations came in two categories: arcade and management. Few, if any, ever bothered with the all-important STRATEGY which a successful manager is to master, both before a match when deciding on squad selection, and during the match when high-drama, real-time decisions must be made on tactics, substitutions, set pieces and player deployment. But now, for the first time on any major computer, there is a superlative management game that encompasses all forms of soccer strategy: it is called **FOOTBALL TACTICIAN**.

Team selection, needless to say, remains a critical element in any successful campaign: and here you will be aided with a wealth of player data, never seen in any soccer program before. Gone are the days when a player was given a single skill level. Each player is now analysed in up to 20 different aspects, enabling you to select the side best suited for the match in hand. And then to the BIG innovation of **FOOTBALL TACTICIAN**: full on-line, real-time involvement during the match! For the first time ever, you will, as a manager, be able to alter your strategy: choose a defensive or offensive system, mark certain opponents, drop back some of your players if the pressure is tough, decide exactly when substitutions should be made, play the off-side trap, go for quick counters, etc... With full on-screen commentary and minute-by-minute feed-back, you're as involved in the match as any of your players! When you further consider that this game is written in 100% machine code (unlike scores of other slow-motion offerings which are written in basic), that up to twenty two users can play this game at the same time, that accurate records are kept on all 440 players in the first division, right down to their exact market valuation, that a built-in editor allows you to change any player's or manager's name, you will realise that this is no ordinary soccer manager. THIS is the REAL THING. You're in charge. You manage your side before and during the match. Nothing is left to chance. Can you rise to the challenge? Try **FOOTBALL TACTICIAN** and prepare yourself for the ultimate football experience.

Amongst the many features: intelligent computer behaviour, lively transfer market, ability to replay ANY match of the week with full commentary, three levels of commentary from highlights only to every single ball challenge with all players named, ability to retrieve any fixture from the last 21 seasons, top scorers chart, friendlies, speed control, twenty player squads including the VERY LATEST transfers right up to this very week, full European Cups program with every single European player accurately named, selectable positions, automatic and intelligent substitutions by computer opponents based on player fitness, fatigue and tactics used; computer opponents will automatically change tactics to respond to situation on the field, ability to utilize to full advantage any extra memory fitted, and many more!



FREE UPDATES OFFER!

Because Talking Birds are committed to providing the most up-to-date football manager ever, purchasers of FOOTBALL TACTICIAN will receive free update disks for a whole year! As players are transferred, injured or revalued, as managers are sacked and teams promoted or relegated, it is essential that up-to-date data disks should be made available to the serious user. Beyond the first year period, this service will be available as an optional extra.

AMIGA and ATARI ST/STE Double-sided disk.

Please rush 1 copy of **FOOTBALL TACTICIAN**

I own an AMIGA A500 1meg /A500+ A500 1/2 meg ATARI ST/STE

Name
Address

I enclose cheque for £19.95

My Visa number is

Visa or Access orders: same-day dispatch. Overseas please add £1 p&p

TALKING BIRDS 0702 523607

5 Minster Close Rayleigh Essex SS6 8SF



EASY AMOS

Specially designed for the beginner, *Easy AMOS* is more than just a computer language. Based on the highly successful *AMOS*, it has many more examples and detailed explanations to help you learn.

Description	Price	Order No
Easy AMOS	£29.99	AF247



Stereo Master

This updated version of Microdeal's *MasterSound* is an ideal entry level sound sampler. Its numerous features, and improved easy-to-use graphic interface, make this an excellent bargain for budding music freaks.

Description	Price	Order No
Stereo Master	£29.99	AM234



AF T-shirt

The exclusive limited-edition *Amiga Format* T-shirt is now available to *Amiga Format* readers. It features the 'Lichtenstein' pop-art cover of Issue 20 in a large four-colour back print, new logo on the front.

Description	Price	Order No
Amiga Format T-shirt	£8.99	AM225

AMIGA FORMAT

182

JUNE 1992

Amiga Format Mail Order

We've picked out the best and we bring it to you at a bargain price!

512K Expansion

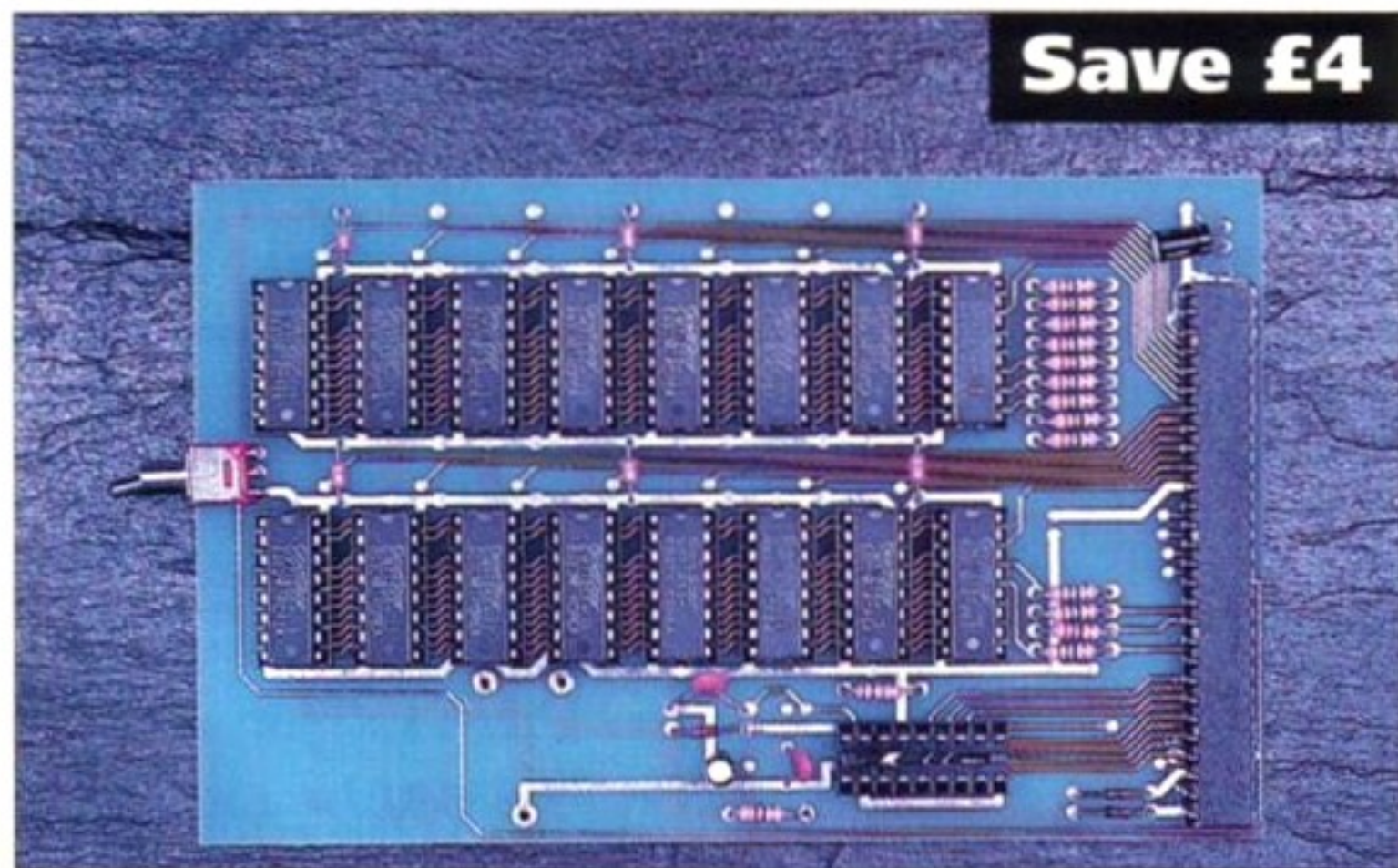

Made by WTS in the UK, this isn't the most glamorous memory expansion you'll ever see: but it gets the job done and it means we can bring 512K users the memory expansion you need at the lowest possible price! It also comes with a battery-backed-up clock, so you need never set the time again. More and more software is being produced that will only work properly on a one megabyte machine: and if you don't have an expansion, you're missing out on the complete full-price programs, like *Vista*, brought to you on Coverdisk 33, or *PageSetter*, Coverdisk 34, or this month's *Spectracolor*. Get upgraded!

Description	Price	Order No
512K RAM Expansion	£25.99	AM237

Fun School 4



The latest versions of the top-selling home educational programs are here! The *Fun School* series aims to teach basic skills to children via enjoyable games. The new series comes in three different flavours, aimed at three age groups: Teddy looks after the under fives, Freddie the Frog caters for the five-to-seven year olds, while Sammy the Spy is there for eight-to-elevens. Each age level has six different games, which teaches and tests different facts and concepts.

Description	Price	Order No
Teddy Disk	£17.99	AM231
Frog Disk	£17.99	AM232
Spy Disk	£17.99	AM233



SAVE £6

Oh No! More Lemmings

Who could complain about getting more of the top game of 1991! This adds another 100 levels to the original, and we're offering you the stand-alone version, so you don't need the original *Lemmings* to play it!

Description	Price	Order No
Oh No! More Lemmings	£19.99	AM236

SAVE £7

Celtic Legends

Huge, beautifully-presented and intriguing game based around a board-game-style hex system, with the emphasis on combat. Absorbing and intelligent: rated 85 per cent in *Amiga Format* Issue 30.

Description	Price	Order No
Celtic Legends	£23.99	AM235

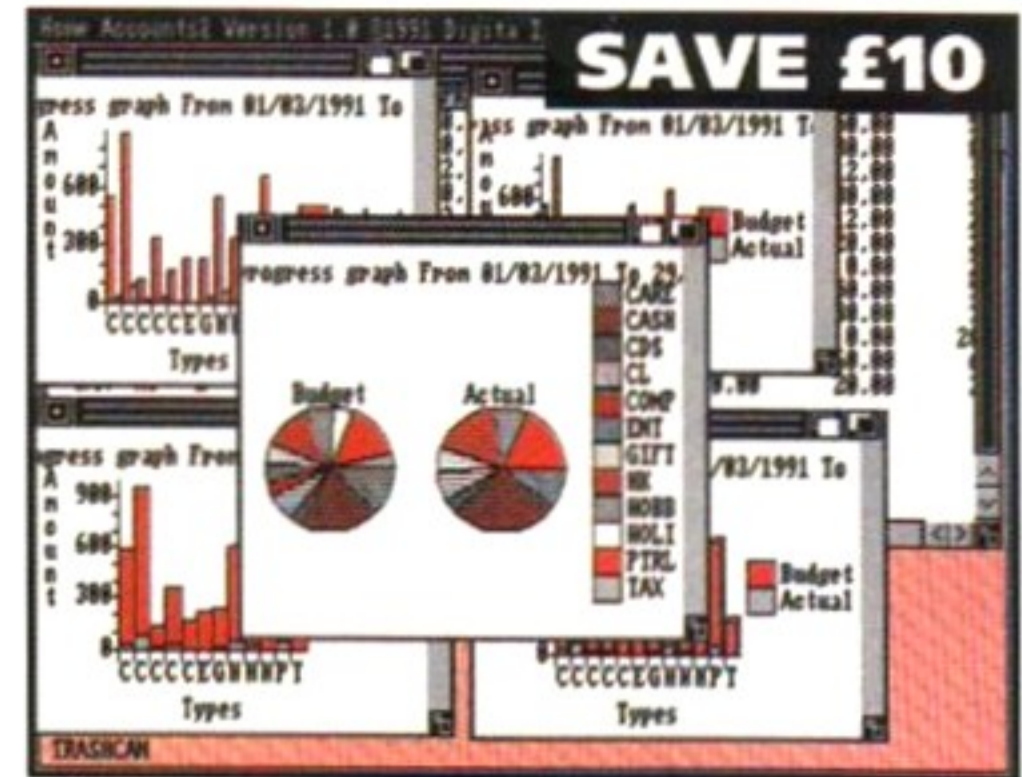
SAVE £10

Home Accounts 2

Described by *Amiga Format* as "a package which will suit any household", this is the ideal way to keep track of your financial affairs, from what's in your cheque account to how much is left after the bills!

Description	Price	Order No
Home Accounts 2	£44.99	AM229

HOTLINE 0458 74011

No Hidden Extras

Back Issues

Why miss out just because you didn't buy an issue when it went on sale? Back issues come complete with Coverdisk: see Pages 156-7 to find out what was in each issue. While you're about it, why not get a binder to collect your new issues?

ISSUE	Price	Order No
Issue 9	£4.00	AMF9
Issue 14	£4.00	AMF14
Issue 16	£4.00	AMF16
Issue 17	£4.00	AMF17
Issue 19	£4.00	AMF19
Issue 21	£4.00	AMF21
Issue 22	£4.00	AMF22
Issue 23	£5.00	AMF23
Issue 24	£5.00	AMF24
Issue 25	£4.00	AMF25
Issue 27	£4.00	AMF27
Issue 28	£4.00	AMF28
Issue 30	£5.00	AMF30
Issue 33	£5.00	AMF33
Issue 34	£5.00	AMF34
One binder	£4.95	AM108
Two binders	£9.00	AM109

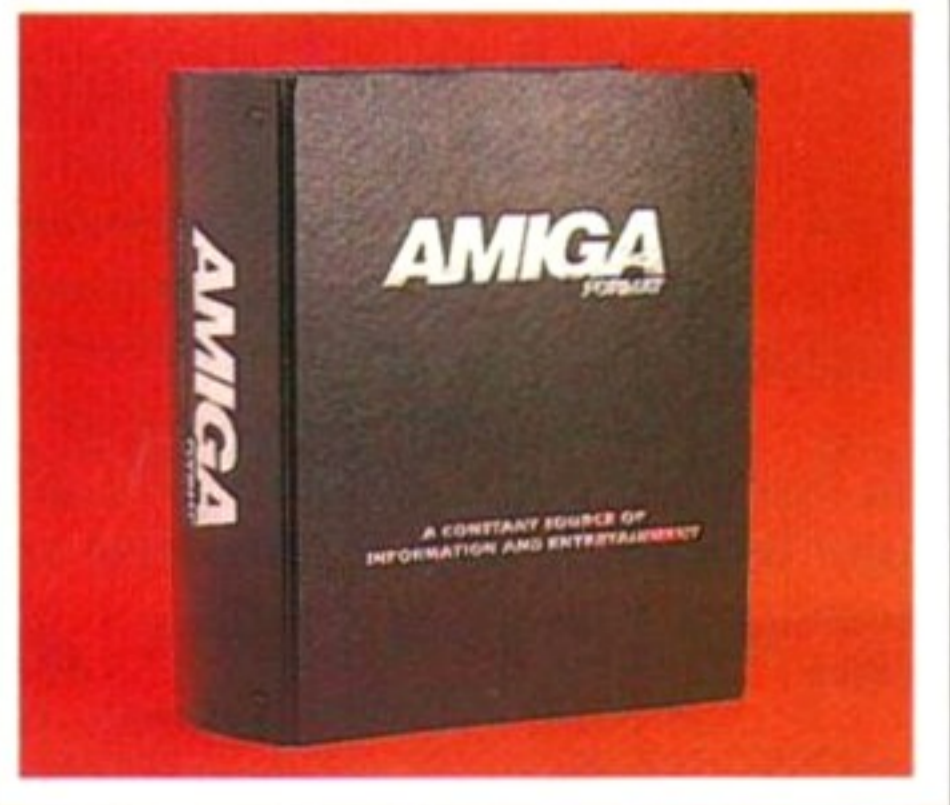
SAVE £5

Award Winners Compilation

What a combination! The Format Gold ground-breaker *Populous*, stunning footie fun in *Kick Off*, the cartoon-on-a-disk *Space Ace* and the top-class puzzle game *PipeMania*: all rolled into one great package.

Description	Price	Order No
Award Winners Comp	£20.99	AF245

SAVE £10

New Technosound Turbo

The newly updated sampler from New Dimensions allows you to grab digitised sounds, then sequence them into simple compositions. Package contains new cartridge, updated manual and set of audio leads.

Description	Price	Order No
Technosound Turbo	£29.95	AF246

See our remarkable Subscription offer on Page 156!

Amiga Format Mail Order

Name _____
 Address _____

 Post code _____
 Telephone No. _____

SEND THIS FORM TO:
Amiga Format,
Future Publishing
Ltd, Somerton,
Somerset, TA11 6TB

Description	Price	Order No.
Total Order		

Please do not send cash, only use method of payments listed below

Method of payment (please circle) Access • Visa • Cheque • PO
 Please make all cheques payable to **Future Publishing Limited**.
 All prices include postage, packing and VAT

For overseas orders call Nikki for prices on +44 458 74011

Credit Card No. _____ Expiry Date _____

Sequencer One

On the second Coverdisk of the Christmas special issue we brought you the best special offer you could have: the complete **Sequencer One** music package, RRP £89, for next to nothing. If you missed out, you can get your copy from Back Issues for only £5. But it doesn't stop there! Make the most of **Sequencer One** by taking advantage of the **host of extras** which build up the **most powerful easy-to-use music-making system** there is!



Sequencer One, the excellent beginners' music program we gave away with Issue 30. If you missed out, get it now from our Back Issues department on Page 184!

THE HIT KIT!

A music composition system to use with both *Sequencer One* and *Sequencer One Plus*. It can help you to create professional-sounding drum tracks, bass lines and other accompaniments in a wide range of musical styles (eg ballad, blues, house, disco, latin, reggae or techno). Very little previous musical knowledge is needed to obtain frighteningly rapid results! Can you write a number one hit? Here's the kit to help you, only £24.95 (RRP £29.95)!



SAVE £5!

Description
The Hit Kit!

Price
£24.95

Order No
AM237

AMIGA FORMAT

184

JUNE 1992



SAVE £90!

SEQUENCER ONE PLUS UPGRADE KIT

Don't miss out on this incredible offer! Upgrade to *Sequencer One Plus* to take advantage of a host of extra features including the unique Juke Box screen and Gajits' new 'Diamond Drag' note editing system. Also includes: tempo maps, auto count in, MIDI sys ex handling, track solo, extra quantise options, and much more! All of this will sell for £129.95 (RRP). For a short time only, *Sequencer One Plus* is available as an upgrade kit for *Sequencer One* owners (and that includes everyone who has the program from **Amiga Format** Coverdisk 30) at just £49.95 (RRP). But we're offering it to you at a mere £39.95 for an amazing total saving of £90!

Description	Price	Order No
Sequencer One Plus	£39.95	AM235



SEQUENCER ONE USER GUIDE

Contains not only the full program User Guide but also a personal User Registration Card. The User Guide includes a beginners' introduction to sequencing and MIDI, lots of helpful illustrations and examples, and a full index. The User Registration Card entitles you to free update information and the Gajits Telephone Helpline support service. You can benefit from all of this for the special price of only £6.95!

Description	Price	Order No
Sequencer One User Guide	£6.95	AM236

Graphics Workshop

A FUTURE BOOK

Graphics Workshop

Powerful paint and animation at your fingertips!

**AMIGA
FORMAT**



The complete Amiga Format guide to getting the best from Graphics Workshop, with full explanations of all the advanced paint and animation features plus tutorials, hints and techniques

IN ASSOCIATION WITH
HOLOSOFT TECHNOLOGIES

The Graphics Workshop, which we gave you for practically nothing on the Coverdisk of our Christmas Special issue, is a powerful paint and animation program. In no time, you'll discover what an excellent package it is, and want to use it more. Why not get the most out of it by buying the full instruction book and tutorial guide, specially rewritten by **Amiga Format!**



SAVE UP TO £25!

THE SAMPLE SERIES

A collection of five volumes of IFF format digital sound samples for use with *Sequencer One* and *Sequencer One Plus* (as well as other programs using IFF samples). Each volume contains up to 80 high-quality samples and includes a specially-written demo song to demonstrate the capabilities of the samples.

There are five volumes to collect:

1. Percussion and Effects
2. Guitars and Strings
3. Brass and Woodwind
4. Synth and Vocals
5. Piano and Keyboards

Each volume costs just £9.95 here (RRP £12.95). The complete set can be bought for only £39.95, saving you nearly £25!

Description	Price	Order No
Sample Series 1: Percussion	£9.95	AM238
Description	Price	Order No
Sample Series 2: Guitars	£9.95	AM239
Description	Price	Order No
Sample Series 3: Brass	£9.95	AM240
Description	Price	Order No
Sample Series 4: Synth	£9.95	AM241
Description	Price	Order No
Sample Series 5: Piano	£9.95	AM242
Description	Price	Order No
Sample Series Complete Set	£39.95	AM243

All prices include postage, packing and VAT



HOTLINE 0458 74011

AND REMEMBER!

If you missed out on Issue 30 and your copy of *Graphics Workshop*, you can order the magazine from our back issues (Page 164) for only £5!

only £16.40
including tutorial disk

Order form

Name _____

Address _____

Post code _____

Telephone No. _____

Description	Price	Order No.
Total Order		

SEND THIS FORM TO:
Amiga Format,
Future Publishing
Ltd, Somerton,
Somerset, TA11 7BR

Do not send cash
through the post,
with your mail
orders

For overseas orders
call Nikki for prices
on +44 458 74011

Method of payment (please circle) Access ● Visa ● Cheque ● PO

Please make all cheques payable to Future Publishing Limited.

Credit Card No. _____ Expiry Date _____

GASTEINER

Tel: +44 081-365 1151
Fax: +44 081-885 1953

Trade & Educational
Orders Welcome

Technologies

Credit Cards
Welcome

Personal Callers
Welcome

Presenting an outstanding range of products from **GASTEINER**

THE TRACK BALL



Excellent quality three button track ball with click & hold. Smooth, precise, and priced at

£39.95

OPTICAL MOUSE

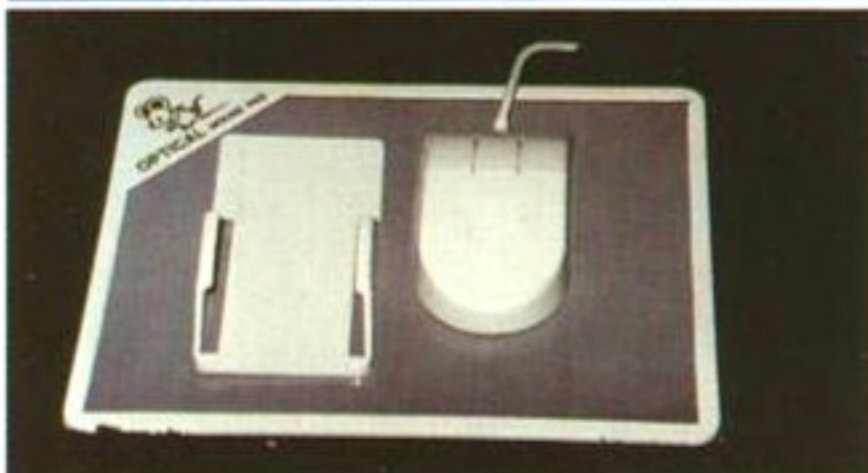

Fast 300dpi resolution ideal for DTP. Includes pad & holder. 600mm/sec tracking speed

£35.00

Auto Mouse/Joystick Switch



Allows selection of mouse or joystick

£17.95

POWER SUPPLY



for A500, original Commodore

£34.95

1.3/2.0 Kickstart Switch **£19.95**

Boot Selector for

A500/A2000

£17.95

CORDLESS MOUSE



NEW!!

Fully rechargeable with long 6ft transmission distance.

£49.95

OPTO-MECH MOUSE



High resolution 300dpi mouse, with micro-switch buttons. Smooth and reliable. Long 6ft cable.

£19.95

Extra durable replacement mat for Optical Mouse

£9.00

SCANNER



U.K.'s best selling scanner - 400dpi, 256 Greyscale, with Touch-Up software and Merge It (lets you scan full A4 page)

£169.00

OKTAGON 508



NEW!!

MEMORY MASTER



A New Age fast RAM expansion for Amiga 1500/2000/2500/3000, with 2Mb memory.

£129

Expandable to 4/6/8 Mb.

ALF 2008



NEW!!

Universal HardDisk controller. Fully configurable, highly adaptable, totally compatible.

Controller £129

+2MB **£189**

+6Mb **£309**

+4MB **£249**

+8Mb **£369**

RAM UPGRADES

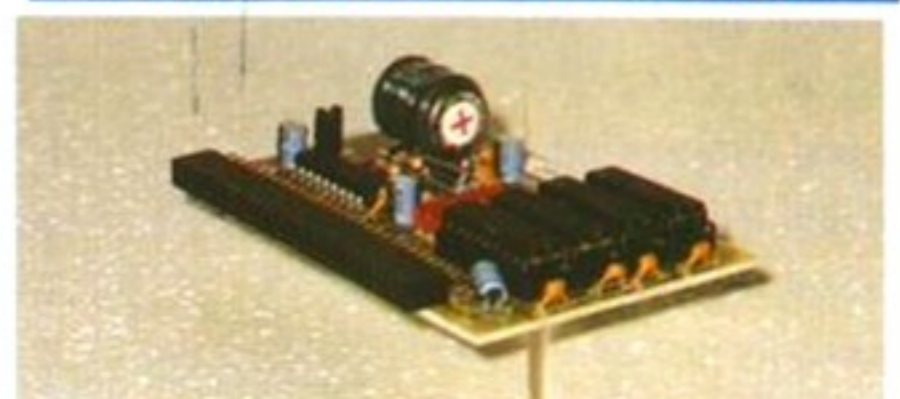

A500 1/2 Mb RAM Upgrade **£26**

2.5 Mb RAM Upgrade **£99**
with clock

A500+ 1/2 Mb RAM Upgrade **£39**

1 Mb RAM Upgrade **£79**

GASTEINER Unit 3 Millmead Business Centre, Millmead Road, London N17 9QU

All trade marks acknowledged. Prices and specifications may change without prior notice. Prices include VAT but do not include delivery.

AMERICAN FOOTBALL COACH

on the Amiga (1 Meg only)

"AMERICAN FOOTBALL COACH is a good game. It's certainly worth a look as the game play is superior to many full-blown simulations.

I'll end by saying that it's extremely tough to have a winning season because the AI (artificial intelligence) definitely plays hardball. Are you tough enough?"

REVIEW...STRATEGY PLUS ISSUE 16..FEB 1992.

YOUR TASK is to get LONDON's name printed on the trophy in 5 years against some of the best coaches ever on the Amiga

YOU HAVE important information via SKILL RATINGS (that work) and comprehensive match & season STATISTICS (that inform).

YOU WILL SEE, on our special chalkboard, every play of every match of every season and YOU pick the players for EVERY play but be careful of OVERUSE as players get tired.

KICKOFFS...PUNTS...RUNBACKS...FUMBLES...DROPPED CATCHES...SACKS...BLITZES...SAFETIES...BOOTLEGS...DEFENSIVE LINE SHIFT...RUNS...REVERSE RUNS...INTERCEPTIONS, etc etc but most of all you will get REALISM.

Every play is a challenge in itself...no matter how good you are, or get...you will NEVER be sure of winning here...but when you do... it's a real achievement...

Winning the title in season 5 has been done...but only by the very best!

40 OVER LEAGUE CRICKET

on the Amiga (1 Meg only)

GUIDE YOUR CHOSEN COUNTY TO THE LEAGUE CHAMPIONSHIP

Up to 18 player game...play against human or tough, tough, Computer opposition.

Each match takes about 90 minutes to play (at 40 overs level) but you can play any number of overs against human opposition...THOUGHT PROVOKING STRATEGIC, GAMEPLAY...but little time to think...

Ball by Ball text based commentary with appeals HEARD & SHOWN graphically...GAMBLE option to take quick singles if you need them...3 types of wicket...pick BOWLERS to suit...Full scoreboard information for decision making...change all tactics every ball if needed.

VERY REALISTIC responses to your Gameplay. VERY LITTLE LUCK INVOLVED..Best tactics usually WIN.

To get your copy of either game...send cheque/PO for £9.75 incl p&p and we will post within 24 hours of money clearance. OR £18.50 FOR THE TWO GAMES!!

YOUR NAME _____
ADDRESS _____

Please tick game/s ordered
CRICKET..... A. FOOTBALL.....

COMPOSER SOFTWARE (AP)
'BLENHEIM CHASE',
THE NARTH,
Nr. MONMOUTH
GWENT NP5 4QN
Tel: 0600 860706

NEITHER GAME IS COPY PROTECTED - YOU CAN PLAY ANY NUMBER OF SEASONS.

OUT OF THIS WORLD!

ZERO-G DATAFILE AMIGA Music Samples

A series of ten five-disk volumes,
for musicians, DJ's, programmers
and dance producers

"Unreservedly excellent!"
Music Technology

A fantastic collection of dance music samples (IFF 8SVX format) for use with ALL major Amiga sequencing packages including MED, Music X, Protracker and Sequencer 1.

OUT NOW!

Breakbeats Volume 1

A selection of superb quality samples, all looped to provide a continuous backing track for your creations!

"Very professionally prepared"
CU Amiga, April 92

Vocals Volume 1

An assortment of sampled vocals including Ad-Libs, Vocals Hits, FX and Speech, all ready to bring your music to life!

The entire Zero-G library is also available on 3 standard CD's (1000 samples on each) for sampling into any hardware samplers - £49.95 each or £129.95 for all three.

To order Zero-G Datafile Amiga sample sets, or the CD versions, call our 24-hour order line on 0442 870681 (Access/Visa/Amex) or Fax us on 0442 877266

TIME+SPACE, PO Box 306, Berkhamsted, Herts HP4 3EP, England

Please send me: Zero-G Datafile Amiga Vol.1. "Breakbeats 1" @ £29.95
 Zero-G Datafile Amiga Vol.2. "Vocals 1" @ £29.95

I enclose a Cheque/Postal Order to the value of £ _____ made payable to "TIME+SPACE" or: Please debit my Access/Visa/Mastercard/Amex credit card:

NUMBER: _____ / _____ / _____ EXP. DATE: _____ / _____ / _____

NAME AND ADDRESS: _____

POSTCODE: _____ TELEPHONE: _____

(ALL PRICES INCLUDE V.A.T. and post) DELIVERY: Orders despatched within 14 days of receipt of payment. UK: post free, International Order: please add

£5.00 Air-mail £10.00 Express Air-mail.

WHAT WE'VE DISCOVERED SO FAR

In the first four parts of this series, we've been learning how to use Workbench and the CLI or Shell to do all the basic 'house-keeping' jobs. Let's take a brief run-through of what we've covered so far...

The Workbench disk contains two different 'interfaces' for controlling your Amiga. One is the Workbench itself, where it's all done using icons, menus, windows and the mouse. The other is the CLI or the Shell (both are pretty much identical, but the name 'CLI' is often used to refer to both) where everything is done by typing in commands.

Both interfaces give you control over a hidden thing called AmigaDOS (Amiga Disk Operating System) which basically lets you control what's happening to things on a disk.

All items of data on a disk come under the general name of 'files', though there are actually two kinds: programs themselves, and data files which are created by those programs (like a letter you've created in a word processor, or a picture you've created in *Deluxe Paint*). The Amiga manuals call programs 'tools' and files 'projects', but nobody else does.

There are basically four main things you can do with files on a disk. You can create new ones, like when you save a picture out of *Deluxe Paint*. After it's there, you can delete it so it no longer exists; you can make a copy of it, choosing whether the copy remains in the same place or moves somewhere else; or you can move it from where it is to another place.

Apart from files, the other things you can have on a disk are drawers, also known as directories. If you think of the disk as a filing cabinet, these are literally like the drawers: they're used to help you organise your files into groups. What distinguishes a drawer is that no two files inside it can have the same name: but a file in a drawer can have the same name as a file outside the drawer.

THINGS YOU SHOULD BE ABLE TO DO BEFORE YOU GO ON...

If you've read all the series so far, you should know how to do all these things using the Workbench, or the CLI, or both:

- Format a disk
- Rename a disk, drawer or file
- Copy a disk, drawer or file
- Delete a disk, drawer or file
- Create a new drawer
- Move a file or drawer from one place to another

If you're not quite sure how to do any of these things, then either go back and read the previous instalments of this series before you start or look it up as you go along.

Getting to grips with Workbench

In part five of the series that's specially for people who want to learn about the Workbench disk, we're going on to some advanced CLI stuff and we'll learn the basics of making a self-booting disk!

WHAT TO DO IF YOU'VE MISSED PARTS ONE TO FOUR...

The series started in Issue 31 (Feb 1992) of *Amiga Format* with a look at the theory behind Workbench, which is useful but not essential. Copies are still available from our Back Issues department on Page 156.

Part Two in Issue 32 (March 1992) covered basic techniques for operating your Workbench and how to format and rename a blank disk. Unfortunately this sell-out issue is not available as a back issue. If you have a friend with a copy you have our permission to photocopy the article.

Part Three in Issue 33 (April 1992) went into all the details of doing the main functions described above. Part Four of the series in Issue 34 (May 1992) recapped everything we have done to date and both are still available from our Back Issues department.

ARE YOU READY to take a step on and become a real hard-core Amiga user? Yes? Good! Because we're going to do some really intensive messing about with the CLI and you're going to create your very own self-booting disk. And you'll probably discover it's all a darn sight easier than you thought it was, too!

Before we actually crack on with it, let's take a quick look at some of the theory behind it so you've got an idea of what we're going to be doing later on. Oh, and before we start, here's a couple of notes.

Most important thing is that we're going to be using the Shell for the vast majority of this. There are certain things you could probably do using the Workbench instead, but for the sake of learning more about the CLI it's worth doing it this way.

I'm actually going to be using Workbench 1.3, but we've checked it and everything works exactly the same on Workbench 2. Finally, remember that although we often refer to it as the CLI, the Shell is actually more or less exactly the same thing. OK, let's get theoretical!

Just in case you're not precisely certain what a self-booting disk is, let's take a look at that first. It's simple enough, really.

If you've just switched your Amiga on without a disk in the drive (and assuming you haven't got a hard drive attached), it sits there showing you the screen that says "put a disk in if you expect anything more to happen". For older Amigas that's the picture of a hand holding a disk: for Workbench 2 Amigas, that's the purple screen with the animation of a disk being put into a disk drive.

At this point, if you put a self-booting disk into the drive, the Amiga will load up from the disk and start doing something. The Workbench disk and most game disks are self-booting.

Alternatively, if you put in a disk that isn't self-booting, the Amiga will take a quick look at it and do nothing. That's all that a self-booting disk is: one that actually starts up the Amiga and does something.

Disks that aren't self-booting have to be accessed from the Workbench, so you load up the Workbench first from its disk, then take out the Workbench disk



It doesn't really make sense when it's sitting still on the page, but this is what your self-booting disk will do: display a series of pretty pictures for you as a slideshow.

and put the non-self-booting disk in.

While we're on the topic, it's worth mentioning that self-booting disks come in two kinds: standard Amiga ones, and non-standard ones. The difference is that with a standard Amiga boot disk, you can treat it as if it was not a boot disk.

In other words, if a self-booting disk is a standard Amiga one, you can load up Workbench first, then put the disk in the drive. Workbench will recognise it and you can use it from Workbench the same way you could with a non-booting disk.

The difference with non-standard self-booting disks – like the vast majority of game disks, for example – is that if you boot Workbench first and try to run them from there, they won't work. Workbench won't even recognise them: you'll get that disk icon with DF0:BAD or DF0:??? under it, just as if the disk were an unformatted blank disk or a disk from another type of computer.

The reason for this is that most software houses, who make the games, don't want you to be able to make copies of their game disks from Workbench. We'll find out how they stop you from doing that in just a moment...

What is it, then, that makes a self-booting disk different from a non-booting disk? Well, basically it has something extra on it called a 'bootblock'. A bootblock

Continued overleaf

is simply a small piece of data at the start of a disk which tells the Amiga that it should start up from this disk. A 'block', incidentally, is a term for a chunk of data on a disk - you know what 'boot' means already.

When we're making our own self-booting disk, we'll need to put a bootblock on it. We'll do this as the very last step, when we've prepared the disk we're going to make self-boot. It's done using a CLI command called 'install', which writes a standard Amiga bootblock onto the disk by copying it from a standard one on the Workbench disk. Simple enough, eh?

Incidentally, this is why those non-standard self-booting game disks can't be recognised by the Workbench: they have a special bootblock written by the game programmers. These are known as 'custom bootblocks', in the same way as an individually-prepared non-standard car is a custom car.

Where this becomes terribly important is if you are concerned about viruses. The vast majority of viruses are bootblock viruses: they actually change the bootblock of the disk they're on. Now, as you may well know, you can use a virus-checking program to see if a virus is on your disk: but the tricky bit is what happens if you find one.

If you have a virus on a standard Amiga disk, you can get rid of the bootblock virus by simply writing a new bootblock onto the disk. But if the disk has a custom bootblock, you can't write a standard bootblock onto it, because then it won't work any more.

For this reason, we often recommend that you don't virus-check game disks: just switch off the computer for at least 30 seconds before you start up a new game disk and that way you can be sure that viruses won't spread. Alternatively, you can get PD programs which will read the bootblocks of your game disks and store them on a disk, just in case you ever need to restore them to health, but you have to be pretty confident of what you're doing to do this.

So, one thing we're going to need on our self-booting disk is a bootblock. After that, there's a couple of other things that every standard Amiga boot disk must have. We'll take a quick look at what these are, but it's worth briefly explaining how a disk starts up your Amiga.

When you switch the Amiga on, the Kickstart chip inside the Amiga prepares the whole thing for use. Kickstart contains the basics of the Amiga's operating system, so it prepares the Amiga to check the disk drive for something to happen.

When you put a self-booting disk in, the Amiga first checks that the disk has a bootblock. It does, so the Amiga then starts loading data from the disk. The first thing it does is open an AmigaDOS screen (remember that AmigaDOS is the Amiga's operating system, the thing that the CLI and Workbench give you control of).

To do this it needs certain information and so it looks for a directory on the boot disk called Devs, which must contain a file called system-configuration. This reads off basic information about how you want the AmigaDOS window to appear, such as the colour.

After that, it begins to wonder what program the disk is going to load, so it looks for a file called the startup-sequence. This is an AmigaDOS program file: essentially, it's like a word processor document in which you have typed a whole bunch of CLI commands. Startup-sequences can be quite simple, as you'll find out. It must also live in a specific directory on your disk, a directory called simply 's'.

Right, so you know now what a disk has to have on it to be self-booting: a Devs directory with a system-configuration file; an s directory with a

startup-sequence file; and a bootblock. Then, of course, you've got to have a program for it to run. We're almost ready to go...

There's one last thing before we start. We're going to be using a whole lot of CLI commands in this part of the series, but do you know what a CLI command is?

Put it another way: do you know how to run a program from the CLI? No? Well, it's actually the easiest thing there is: all you have to do is type the name of the program, and the program will load. Easy, eh?

In actual fact, CLI commands are short programs. So when you type a CLI command, you are running a short program. This means you can include as many or as few of the CLI command programs as you like on your disk. Anyway, that's pretty much by the by: you'll get a better understanding of this as we go on. Are you ready to make a disk?

1 Format and name a disk

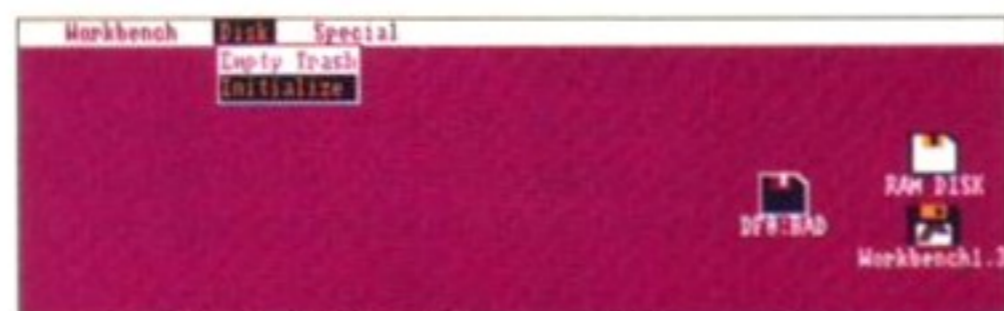

Format a blank disk by clicking on its icon and selecting the correct menu option - you do remember how, don't you?

First thing to do is boot up your Workbench disk, get a blank disk and format it. Then rename it to whatever name you fancy: I'm going to call my disk Fish, simply because it's short and handy. It's probably easiest if you use the same name.

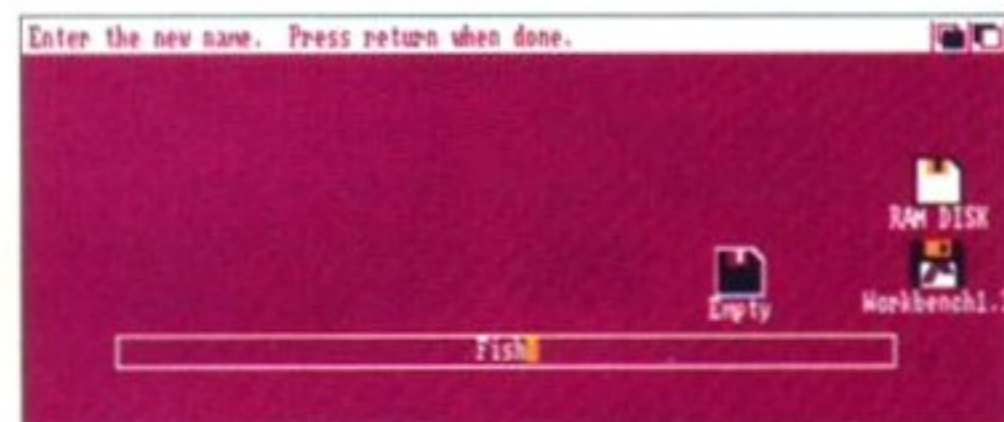

Then give your disk a name - something short is easiest, because you'll be typing it a lot! Don't put spaces in the name. This disk will become your self-booting disk.

2 Get rid of unwanted stuff

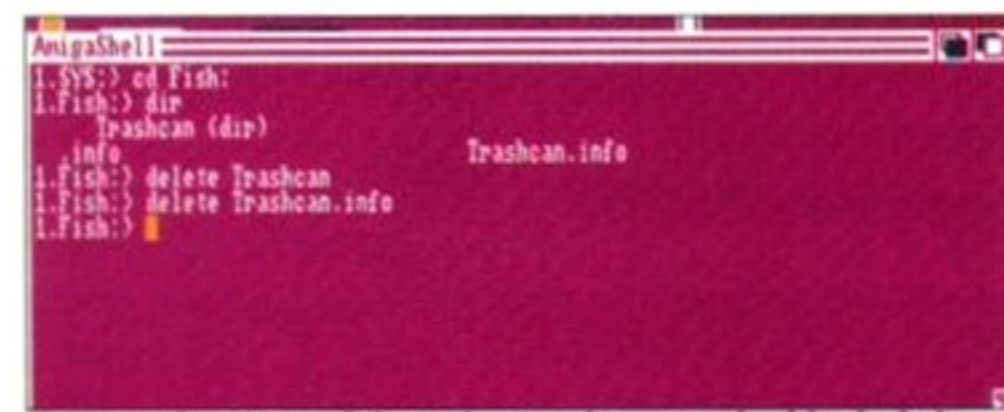

We use the CLI to delete the Trashcan on the blank disk, because we won't really need it and it just takes up space.

As with every blank disk, the disk Fish now has a Trashcan on it which we don't really need, so we'll delete it. In the course of this, we'll try out a couple of new commands.

Remember, when you're using the CLI it's very important to always know which area of a disk you are currently working on. There are certain CLI commands that are very useful for 'navigating' through the different directories of different disks. The first of these is cd which simply means change directory. The second is 'dir' which gives you a list of what's in the current directory (the one you're working in).

Make sure you've got the Workbench disk in the drive and type

cd Fish:

which changes the attention of the CLI to work on the disk Fish. The Amiga should put up a prompt asking you to put the disk Fish in the drive, so do so. Note how the CLI prompt that asks you for the next command changes to the name of the disk you're now working on. Now type

dir

and you should get a list of what's on the disk Fish. You'll notice there's a Trashcan and a Trashcan.info files for the Trashcan's icon, so delete them both. Notice that because you've changed directory to work in the Fish disk, you don't need to specify the path for the files you're deleting. And remember, with the CLI capital letters don't make a blind bit of difference.

delete trashcan
delete trashcan.info



Using the CLI, it's easy to create the two drawers that must be on every self-booting disk.

3 Make the directories you need

Using the mkdir command we've used before, we'll create the drawers or directories we need on the disk. Again, we don't need to specify where because we're already working on the disk Fish.

mkdir devs
mkdir s

Finally, to check your progress try the dir command and you should see the directories you've created.

4 Getting a system-configuration file



We can get the system-configuration file we want from the Workbench disk's own devs directory. This means that your self-booting disk will have the same Preferences setups as your Workbench: like the gaudy maroon colour, in my case!

Right, we need a system-configuration file, but where do we get one from? Well, the best way is simply to pinch one off a disk that exists already, such as your Workbench disk.

64 PAGE COLOUR CATALOGUE

YOURS FREE! WHEN YOU COMPLETE & RETURN THE COUPON BELOW

FREE! FROM SILICA



When you buy your new Amiga computer from Silica Systems, we will give you an additional £359.73 worth of software FREE OF CHARGE, including some great entertainment and productivity programs. These free gifts will introduce you to the world of computing and help you to get off to a flying start with your new Amiga. Plus, with every Amiga from Silica we will give you 16 nights FREE holiday hotel accommodation for you and your family to enjoy a break at home or abroad.

16 NIGHTS HOLIDAY HOTEL ACCOMMODATION

Every Amiga 500 and 600 from Silica comes supplied with a free 72 page colour brochure with accommodation vouchers. These entitle 2 people to stay up to a total of 16 nights in any of 250 hotels with accommodation FREE. All you have to pay for are your meals (prices are listed in the brochure).

ARCADE ACTION PACK:

- 10 Superb entertainment titles:
- ASTERIX £24.99
- CHESS PLAYER 2150 £24.95
- DRIVIN' FORCE £19.95
- LIVE AND LET DIE £19.99
- ONSLAUGHT £24.99
- PIPE MANIA £19.99
- RICK DANGEROUS £24.99
- ROCK 'N' ROLL £19.99
- SKWEEK £19.99
- TRIVIAL PURSUIT £19.95

PRODUCTIVITY:

- PHOTON PAINT 2.0 £89.95
- The recommended paint package
- GFA BASIC V3.5 £50.00
- A power basic interpreter
- TOTAL VALUE: £359.73**

WORTH NEARLY £360!

Commodore AMIGA

LIMITED OFFER! STANDALONE MODEL



- 512K AMIGA 500 COMPUTER
- BUILT-IN 1Mb DRIVE
- A520 TV MODULATOR
- MOUSE CONTROLLER

PLUS! FREE FROM SILICA:

- PHOTON PAINT 2.0
- ARCADE ACTION GAMES PACK
- GFA BASIC INTERPRETER V3.5
- 16 NIGHTS HOLIDAY HOTEL ACCOMMODATION



£299
INC VAT & DELIVERY REF: AMC 0550

CARTOON CLASSICS



- 1Mb AMIGA 500 PLUS £399.99
- BUILT-IN 1Mb DRIVE FREE
- A520 TELEVISION MODULATOR FREE
- THE SIMPSONS - BART v SPACE MUTANTS £24.99
- CAPTAIN PLANET AND THE PLANETEERS £25.99
- LEMMINGS £25.99
- DELUXE PAINT III £79.99

PLUS! - FREE FROM SILICA

- PHOTON PAINT V2.0 £89.95
- ARCADE ACTION GAMES PACK £219.78
- GFA BASIC INTERPRETER V3.5 £50.00

TOTAL PACK VALUE: £916.68
LESS PACK SAVING: £557.68
SILICA PRICE: £359.00

PLUS!
16 NIGHTS FREE HOLIDAY HOTEL ACCOMMODATION

£359
Ref: AMC 0600

NEW! AMIGA 600



The A600 marks the new era of Amiga computers. More compact than the A500, the A600 has a built in 1Mb drive, TV Modulator, internal IDE hard drive interface to easily add a hard drive inside the Amiga. Smart card slot to accommodate ROM, RAM or game cards, easier to access mouse/joystick ports (on the side) and modified expansion slot underneath for additional RAM and battery backed clock.

- 1Mb AMIGA 600 (No Hard Disk) £399.99
- DELUXE PAINT III (0Mb HD version only) £79.99
- 'MYSTERY' GAME (0Mb HD version only) VARIABLE
- 1 YEAR HOME SERVICE WARRANTY

PLUS! - FREE FROM SILICA

- PHOTON PAINT V2.0 £89.95
- ARCADE ACTION GAMES PACK £219.78
- GFA BASIC INTERPRETER V3.5 £50.00

TOTAL PACK VALUE: £839.71
LESS PACK SAVING: £440.71
SILICA PRICE: £399.00

NO HARD DISK - Ref: AMC 0666

£399

20Mb HARD DISK - Ref: AMC 0720

£499

NEW! CDTV DRIVE



Commodore has released their new CDTV drives for the Amiga 500 and 600 computers. Simply plug the drive onto your Amiga and you have the power to:

- USE THE SUCCESSFUL RANGE OF CDTV SOFTWARE. A vast array of titles are available now and more are being released all the time. With the CD's ability to retrieve 540Mb of data (over 610 Amiga floppy disks!), it is the ideal media for software based around entertainment, music, education, reference and much more!
- PLAY NORMAL AUDIO CDs. The high quality CD Player (8 x over sampling) outputs sound quality that is equal to the best top end CD player available today. The CDTV drive gives you the ability to program the CD Player on-screen to select random play, pre-set play order and much more.
- PLAY AND SEE CD+G CDs. Not only do you get high quality audio but CD+G (Compact Disk + Graphics) produces graphics on screen while the track is playing. These graphics are usually based on the theme of the track or can be the lyrics of the song.

A570 CDTV Drive for A500 Kickstart 2.04
£299
REF: CCD 0570

A570 for A500 Kickstart 1.3 Inc Kickstart 2 upgrade
£349
REF: CCD 0583

A570 CDTV Drive for A600 Kickstart 2.05
£299
REF: CCD 0677

ALL PRICES INCLUDE VAT - DELIVERY IS FREE OF CHARGE IN THE UK MAINLAND

SILICA SYSTEMS OFFER YOU

- FREE OVERNIGHT DELIVERY: On all hardware orders shipped in the UK mainland.
- TECHNICAL SUPPORT HELPLINE: Team of technical experts at your service.
- PRICE MATCH: We normally match competitors on a "Same product - Same price" basis.
- ESTABLISHED 12 YEARS: Proven track record in professional computer sales.
- BUSINESS + EDUCATION + GOVERNMENT: Volume discounts available 081-308 0888.
- SHOWROOMS: Demonstration and training facilities at our London & Sidcup branches.
- THE FULL STOCK RANGE: All of your requirements from one supplier.
- FREE CATALOGUES: Will be mailed to you with offers and software/peripheral details.
- PAYMENT: By cash, cheque and all major credit cards.

Before you decide when to buy your new Amiga computer, we suggest you think very carefully about WHERE you buy it. Consider what it will be like a few months after buying your Amiga, when you may require additional peripherals or software, or help and advice with your new purchase. And, will the company you buy from contact you with details of new products? At Silica Systems we ensure that you will have nothing to worry about. We have been established for over 12 years and, with our unrivalled experience and expertise, we can now claim to meet our customers' requirements with an understanding which is second to none. But don't just take our word for it. Complete and return the coupon now for our latest Free literature and begin to experience the "Silica Systems Service".

MAIL ORDER HOTLINE
081-309 1111

SILICA SYSTEMS

MAIL ORDER:	1-4 The Mews, Hatherley Rd, Sidcup, Kent, DA14 4DX	Tel: 081-309 1111
	Order Lines Open: Mon-Sat 9.00am-6.00pm	No late Night Opening
		Fax No: 081-308 0608
LONDON SHOP:	52 Tottenham Court Road, London, W1P 0BA	Tel: 081-580 4000
	Opening Hours: Mon-Sat 9.30am-6.00pm	No late Night Opening
		Fax No: 071-323 4737
LONDON SHOP:	Selfridges (1st Floor), Oxford Street, London, W1A 1AB	Tel: 071-629 1234
	Opening Hours: Mon-Sat 9.30am-6.00pm	Late Night: Thursday until 8pm
		Extension: 3914
SIDCUP SHOP:	1-4 The Mews, Hatherley Rd, Sidcup, Kent, DA14 4DX	Tel: 081-302 8811
	Opening Hours: Mon-Sat 9.00am-5.30pm	Late Night: Friday until 7pm
		Fax No: 081-309 0017

To: Silica Systems, AMFOR-0692-80, 1-4 The Mews, Hatherley Rd, Sidcup, Kent, DA14 4DX
PLEASE SEND A 64 PAGE AMIGA COLOUR CATALOGUE

Mr/Mrs/Miss/Ms: Initials: Surname:

Address:

Postcode:

Tel (Home): Tel (Work):

Company Name (if applicable):

Which computer(s), if any, do you own?

Quit out of the Shell, put the Workbench disk back in the drive and restart the Shell again; notice that the prompt is back to the Workbench disk again. Let's find the system-configuration file we want by typing

```
cd devs
dir
```

and there it is, all waiting for you. Now simply copy it to the devs directory of your Fish disk

```
copy system-configuration fish:devs
```

and check it's there by using the dir command in a slightly different way, with a path that tells it where you want to look:

```
dir fish:devs
```

5 Getting a program to run

For this example, we'll make a slideshow disk that displays pictures. First we'll need the pictures, so get three pictures you've created with *Deluxe Paint* or make some. Copy them across to your Fish disk. If you like, you can rename them as you go to make it simpler later on, like this:

```
copy Pictures:airplane Fish:pic1
copy Pictures:car Fish:pic2
copy Pictures:boat Fish:pic3
```



Our self-booting disk will load a bunch of your pictures one after the other as a slideshow, so you'll need some pictures you've created with *DPaint* or *SpectraColor Jr.*

Because you've got three disks involved – you're copying from the disk with saved pictures on, to your Fish disk, and the Amiga will also need to look at the Workbench disk occasionally – this will involve a heck of a lot of disk-swapping if you've only got one disk drive, so you'll have to be patient!

So now we've got three pictures (mine happened to be of a plane, a car and a boat which I had stored on a disk called Pictures) on our disk. All we need now is the program to display them.

We're going to use a program called *vilbm*, which is a simple freely-distributable program we include on **Amiga Format** Coverdisks to display pictures.

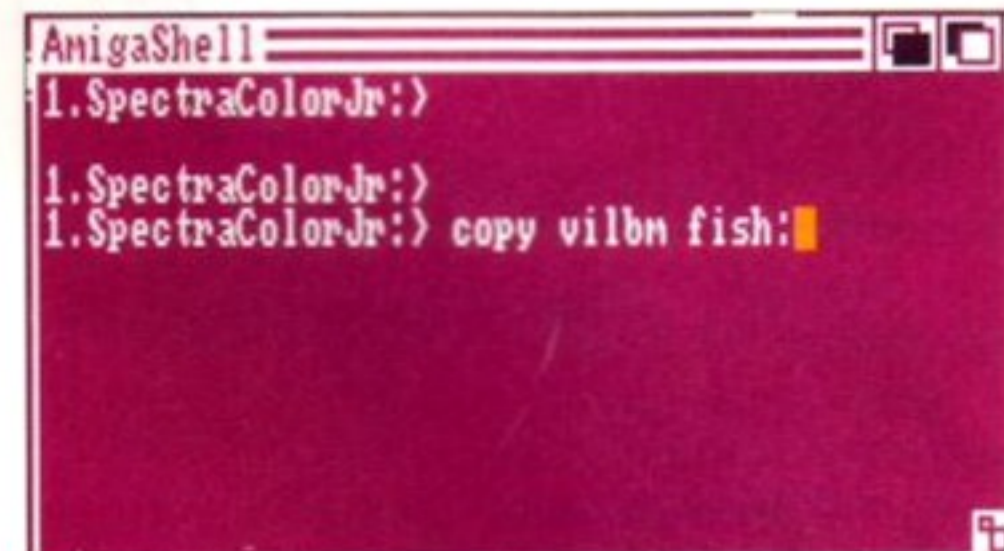

The program we are going to use to display our pictures is called *Vilbm* and is on this month's *SpectraColor Jr* Coverdisk, so we'll need to copy it from there.

We'll find it lurking on the *SpectraColor Jr* Coverdisk and we'll copy it to our Fish disk, so put the Coverdisk in the drive and type

```
cd SpectraColorJr:
copy vilbm Fish:
```

So, we now have a program ready to display our pictures and some pictures to display.

6 Getting a startup-sequence file

This is probably the most complicated part of the operation, because we'll need to use a new program to create the AmigaDOS mini-program that we need. This kind of mini-program is called a script.

Your Workbench disk comes with several program-editing programs on it: we're going to use the simplest, a program called *MEmacs* which is on the Extras disk. First we have to find it, using the `cd` command to get to the directory it's stored in: but there is a problem.

The problem is that Commodore, in their wisdom, have left a space in the name of the Extras 1.3 disk. You have to cope with this by putting quotation marks around the name of the disk. Put the Extras 1.3 disk in and type the following:

```
cd "Extras 1.3:"
cd Tools
```



We load the editing program *MEmacs* to create our startup-sequence by first finding the program on the Extras disk, then typing the program's name followed by the location and the name of the file we want to create.

The only difference we've found in the whole process if you are using Workbench 2 is that the WB2 Extras disk is more sensibly called Extras2.0, without any spaces, so you won't need to use the quotation marks technique. Remember, you can always make sure you get the name of the disk right by moving the Shell window out of the way and checking it on the screen.

You are now in the directory where *MEmacs* lives, so load the *MEmacs* program by typing the following:

```
memacs Fish:s/startup-sequence
```

This tells the Amiga to load the program *MEmacs*, and to edit the file `startup-sequence` on the `s` directory of the Fish disk. This file does not exist yet, so the program will create it.

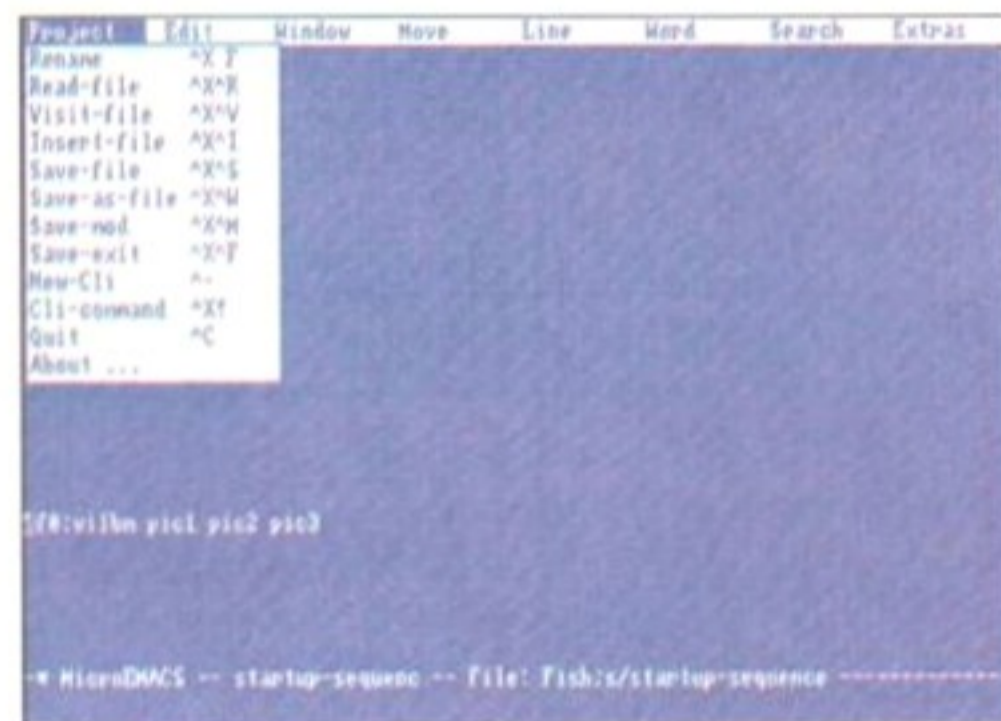

This is the *MEmacs* program itself. All we need to do is type in our simple little startup-sequence and then select the **Save-Exit** menu option.

Now we need to write our startup-sequence. This is simple enough: all we will ask it to do is load the *vilbm* program and display the pictures in order. *Vilbm* works by displaying a list of pictures one by one, moving on to the next one when you click the mouse button, so all we need to do is type the following

```
df0:vilbm pic1 pic2 pic3
```

And that's our startup-sequence all ready! What that line tells the Amiga to do is load the *vilbm* program and then display the pictures you've listed. You can put as many or as few pictures on the list as you want, just as long as you leave a space between each one.

All we need to do now is select the **Save-exit** option from the left-most *MEmacs* menu and our startup-sequence will be written to the `s` directory of our Fish disk for us. Simple, eh?

7 Writing the bootblock

Getting the Amiga to copy a standard bootblock onto our disk is very easy indeed, but there is one small problem. The way that the command works is that the `install` command has to be followed by the name of the drive. If you've only got one drive, this is a problem.

What would happen is that you would type "install drive df0:" and the Amiga would ask you to put the Workbench disk in the drive so that it can load the

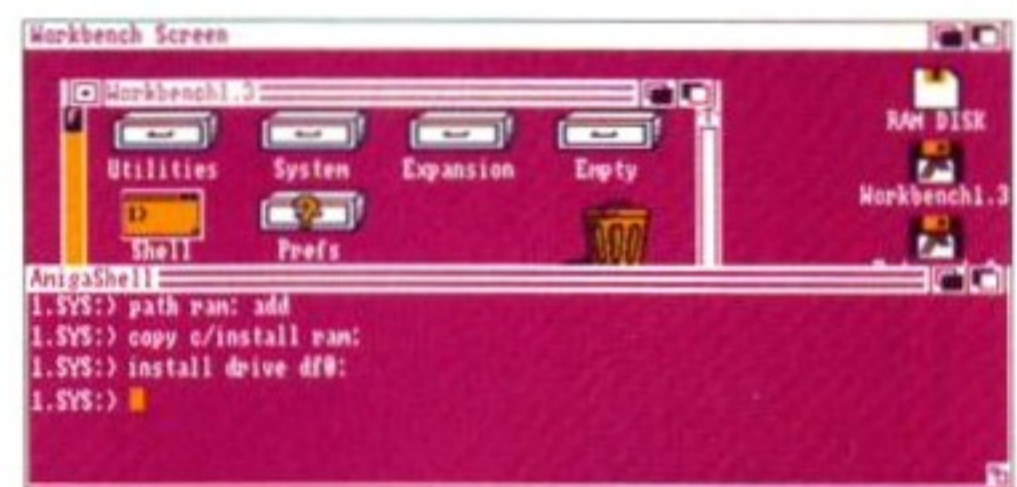

This is some real hot Amiga using for you! We'll get around a problem by using the RAM in an expert way!

install program. It would then try to install the Workbench disk you've put in the drive, which is not too helpful! To get around this, we're going to do some pretty smart Amiga using! First, we're going to make a copy of the `install` command which will live not on the Workbench disk, but in the Amiga's RAM memory! Exit and re-enter the Shell so that the prompt shows you're working from the Workbench disk, type this:

```
copy c:/install ram:
```

Now we're going to tell the Amiga that when it's looking for CLI commands, it must look in RAM as well. We do this by this command, which simply adds RAM as one of the 'paths' down which the Amiga searches for CLI commands:

```
path ram: add
```

Now take out the Workbench disk, put the Fish disk in drive df0: and type:

```
install drive df0:
and it will install a bootblock for us. Done!
```

8 Testing, testing - and maybe success!

Switch the Amiga off then back on and put your Fish disk in the drive. It should boot up with an AmigaDOS screen in whatever Preferences colours you selected. Then it will load up the first picture and wait for you to click the mouse button. When you do, it will load up the second picture, then click again to make it load the third. And there's your first self-booting disk!

THE SURVIVAL GAME

OUR PROGRAMME INCLUDES:-

- On screen animated self-defence course.
- Rescue from personal dangers and facing up to disasters.
- First aid and natural medication.
- Acquiring food, water, fire and shelter.
- Identification of poisonous plants and dangerous animals.
- Interactive emergency communications.
- Direction-finding (SUN MOON STARS).
- Survival psychology.



INCREASE YOUR SURVIVAL CAPABILITIES NOW... YOU MAY NEVER GET ANOTHER CHANCE... PAYABLE TO: INTRACOM APPLICATIONS, UNION BUSINESS CENTRE, 288, HARROGATE ROAD, BRADFORD WEST YORKSHIRE BD2 2SP. PHONE 0274 626174 FAX (SWITCH) ACCESS VISA CD AND PC VERSIONS OUT SOON!



COULD YOU COPE IF INNOCENTLY CAUGHT UP IN THESE SITUATIONS?

- Storms and hurricanes?
- Car crashes?
- Riots and bar brawls?
- Air land and sea disasters?
- Encountering savage dogs? and co-men?

Our comprehensive programme will give you the knowledge to survive these and many more situations in a way that you would never get from a book.



WARNING!

This interactive programme could save the lives of yourself and your family or friends. Our huge 12-disc programme includes hundreds of illustrations, animations and sounds written, compiled and drawn by ex-Special Service Personnel.

IT CAN HAPPEN TO YOU.

- Fear and intimidation can come to anyone anywhere in the world.
- Would you know what to do to protect yourself?
- Do you really have the expertise, or are you fooling yourself?
- Would you make the obvious mistakes like everyone else?



Reach the top with..... LCL Self-Tuition Courses

NATIONAL CURRICULUM*

World leaders • Hons graduate/teacher authors • In educational software charts. • Excellent reviews • £5 off total for 2, £10 off for 3, £17 off for 4.

READING WRITING COURSE (3 - 8 years) *NEW UPDATED*
NATIONAL CURRICULUM (A.T. 1-5) 24 program course teaching reading, writing & spelling with a book, manual and voice tape £24.

PRIMARY MATHS COURSE (3 - 12 years)
Complete course with full screen colour graphics. NATIONAL CURRICULUM (Levels 1-4). 24 programs + a book and a manual £24.

MICRO ENGLISH (8 years - GCSE)
New complete course teaching spelling, reading, writing and oral with real speech, 24 programs and a book and a manual. (Also for EFL) £24.

MICRO MATHS (11 years - GCSE)
Best selling GCSE maths course in UK. For ages 11 upwards in 24 program options plus a book and manual. Superb graphics and music £24.

MICRO FRENCH (Beginners - GCSE)
Complete course with real speech & graphics adventure game, 24 programs + a book and a manual. Superb graphics and music £24.

MEGA MATHS (A level course) Step-by-step course of 24 programs + a book and manual. Full screen graphics for calculus £24.

Most LCL courses run on most computers (PC, ST, BBC, Arc)

A500 PLUS OR AMIGA

(* LCL courses are compatible with the N.C. in so far as it has been finalised) Send coupon and cheques/PO's (+99p P&P) or phone orders or requests for free colour poster/catalogue to:
LCL (DEPT AMF) THAMES HOUSE, 73 BLANDY ROAD, HENLEY-ON-THAMES, OXON RG9 1QB

or ring 0491 579345 (24 hrs)

Name &
Address
Titles
Computer

Phone now for immediate despatch

AMIGA REPAIRS

JUST £44.95 inc.

- ★ Commodore registered
- ★ Over 10 years experience with Commodore computers
- ★ 20 qualified technician engineers at your disposal
- ★ We will undertake to repair your Amiga 500 computer for just £44.95 including parts, labour, VAT and post & packing
- ★ Most computers should be repaired within 24 hours of booking in.
- ★ Prices include full service check, overhaul, soak-test and replacement of power supply unit if necessary
- ★ Repairs to keyboard and disk drive also included (£25 extra if these units are unrepairable and require complete replacements)
- ★ All repairs covered by a 90 day warranty

Upgrade your Amiga from 512K to 1Mb of memory for just £25.00
SPECIAL EXCLUSIVE OFFER:
If you submit your computer to ourselves for repair, enclosing this advert along with just an additional £25, we will supply and fit a 512K memory expansion at no extra cost.

How to take advantage of this exceptional offer: simply send or hand deliver your machine to the workshop address detailed right, enclosing payment and this advert and we will do the rest. (If possible please include a daytime telephone number and fault description).
* If you require 24 hour courier to your door, please add £5 else your computer will be sent back by contract parcel post.

WTS ELECTRONICS LTD
STUDIO MASTER HOUSE
CHAUL END LANE
LUTON, BEDS, LU4 8EZ
Telephone (0582) 491949 - (4 lines)

WTS reserve the right to refuse machines that in our opinion are tampered with, to an extent beyond reasonable repair - normal charge applies.

AMIGA FORMAT

JUNE 1992

193

MJC COMPUTER SUPPLIES

Suppliers of Discount Software since 1984

Educational, Local Authority and government orders welcome. European orders please call or write for a quotation. All goods subject to availability, prices subject to change without notice. E&OE.

Prices include VAT and delivery by post.
Courier delivery available on request.
Please allow 5 days for cheque clearance.

TO ORDER: Credit card orders can be placed by calling the telephone number below - or send a cheque/PO's made out to MJC Supplies to:

MJC SUPPLIES (AF)
Unit 2 The Arches, Icknield Way,
Letchworth, Herts. SG6 1UJ.
Tel: (0462) 481166 (6 lines)

NAKSHA UPGRADE MOUSE

280 DPI quality replacement mouse - pack includes Mouse House, Mat and Operation Stealth game.
MJC PRICE £21.95

NEW - A500 PLUS 1Mb Expansion

1Mb expansion for the A500 Plus - fits in the trapdoor taking your memory to 2Mb - no internal fitting
MJC PRICE £44.95

SUPRA 500RX EXPANSIONS

New memory expansion for the A500 - plugs directly into the HD expansion port - NO INTERNAL CONNECTION

SUPRA 500 RX 1Mb	(expand to 2Mb)	£99.00
SUPRA 500 RX 2Mb	(expand to 8Mb)	£145.00
SUPRA 500 RX 4Mb	(expand to 8Mb)	£209.00

NEW - ROBOSHIFT

Auto sensing joystick/mouse switch box.
MJC PRICE £13.95

CUMANA CAX 354 DISK DRIVE

Quality brand name 3.5" second drive includes thru port, disable switch and FREE Virus X Utility
MJC PRICE £54.95

NEW ROCLITE RF382C DISK DRIVE

New super slimline, super quiet second drive.
MJC PRICE £57.95 (cream only)

GVP PRODUCTS

GVP A500/500 Plus 52Mb Hard Disk: features on board Ram expansion to 4/8Mb with high speed Faastrom controller. Autobooting, includes excellent easy to use installation software.

MJC PRICE £349.95

GVP 286 PC EMULATOR: for use with the A500 Hard Drive. 286 speed running at 16Mhz.

MJC PRICE £229.95

GVP S II Hard Drive (A1500/2000): Quality Quantum drives running as fast as 11ms plus the excellent GVP controller board, with the ability to add up to 8Mb memory (SIMMS).

52Mb version £279.95
NEW - 120Mb version £419.95

SIMM MODULES - £67.95 per 2 meg

SUPRA A1500/2000 MEMORY BOARDS

SUPRARAM memory cards with space for up to 8Mb

SUPRARAM with 2Mb fitted	£145.00
SUPRARAM with 4Mb fitted	£195.00
SUPRARAM with 6Mb fitted	£255.00
SUPRARAM with 8Mb fitted	£295.00

AMIGA WORDPROCESSORS

Kind Words 2 (not A500 Plus)	£29.95
PenPal	£54.95
WORDWORTH v1.1 - Genuine UK version	£74.95

PROTEXT - VERSION 5.5

Latest version of this best selling word processor for those wanting serious processing power, includes new 110 000 word dictionary and Thesaurus (1 meg).
MJC PRICE £99.95

PROTEXT V4.3 - new low price	£39.95
PRODATA V1.2 Amiga	£64.95

NEW - ACTION REPLAY III

MJC PRICE £57.95

MISCELLANEOUS

Deluxe Paint 3 Video Tutorial	£17.95
Stereo Master	£29.95
Techno Sound Turbo	£29.95
GB Route Plus (1mb)	£54.95
Personal Finance Manager	£22.95
Maxiplan Plus	£34.95
Home Accounts 2	£36.95
DELUXE PAINT 4	£59.95
Hisoft Devpac 3	£47.95
Hisoft Hi-Speed Pascal	£69.95

AMIGA EDUCATIONAL

FUN SCHOOL -

probably the best selling Educational Software for the Amiga - great sound and graphics and now conforms to the National Curriculum (FS3 & FS4)

Fun School 2 - 8 programs per pack

Fun School 2	under 6	£12.95
Fun School 2	6 to 8	£12.95
Fun School 2	over 8	£12.95

Fun School 3 - 6 programs per pack

Fun School 3	under 5	£15.95
Fun School 3	5 to 7	£15.95
Fun School 3	over 7	£15.95

NEW - Fun School 4 - 6 programs per pack

Fun School 4	under 5	£16.95
Fun School 4	5 to 7	£16.95
Fun School 4	7 to 11	£16.95

All Fun School programs will work with a standard 512k Amiga and the new A500 Plus.

KOSMOS Answerback Junior Quiz -

includes 750 general knowledge questions and a game reward.....£14.95

Answerback Senior Quiz -

as above but for age 12+£14.95

Factfiles - add-on question packs for the Answerback Quiz:

Factfile Spelling (6-11)	£7.95
Factfile Arithmetic (6-11)	£7.95

KOSMOS Language Tutors: with a vocabulary of over 2500 words + the ability to add your own - up to GCSE level:

French Mistress	£14.95
German Master	£14.95
Spanish Tutor	£14.95
Italian Tutor	£14.95

KOSMOS Maths Adventure: The latest offering from Kosmos covers the National Curriculum maths using a series of four games. There are four difficulty levels and your performance can be kept and printed out. (6-14).....£17.95

ROMBO PRODUCTS

NEW - TAKE 2

New Animation package from Rombo

MJC PRICE £69.95

VIDI COLOUR SOLUTION

Vidi Colour package - including Vidi Digitiser, Vidichrome software and free Photon Paint

MJC PRICE £69.95

RGB SPLITTER - for use with Vidichrome or Digiview. (includes PSU)

MJC PRICE £54.95

COMPLETE COLOUR SOLUTION

Package includes Vidi Amiga, Vidichrome and the RGB Splitter for a complete colour digitising outfit.

NOTE: For best colour pictures you require a video camera or perfect still frame VCR.

MJC PRICE £99.95

Comp Col Solution + Take 2. MJC PRICE £179.95

NEW - MEGAMIX MASTER

New Stereo sampler and digital effects package.

MJC PRICE £28.95

VIDEO TITLING/PRESENTATION

Big Alternative Scroller	£42.95
Broadcast Titler II	£159.95
Broadcast Font Pack	£89.95
Broadcast Font Enhancer Pack	£89.95

ZVP VIDEO STUDIO

Great Video Production package
(1 Meg + 2 drives)

MJC PRICE £89.95

ROCTEC ROGEN GENLOCK

Budget priced genlock, includes fader.

MJC PRICE £99.95

ROGEN PLUS GENLOCK

Includes dissolve/fader control + Power supply.

MJC PRICE £139.95

AMOS - The Creator

NEW - EASY AMOS - Powerful but easy...£25.95

AMOS V1.2 - The original Language.....£32.95

AMOS COMPILER£19.95

AMOS 3D£21.95

LCL SOFTWARE

Primary Maths Course (3-12)	£19.95
Micro Maths (GCSE level)	£19.95
Micro French (GCSE level)	£19.95
Micro English (GCSE level)	£19.95
Reading and Writing Course (3+)	£19.95

TRIPLE R EDUCATIONAL SOFTWARE:

Picture Book: - Four educational games covering the Alphabet, Spelling, Counting and Snap - using pictures to illustrate the answer. (ages 2-5 years)**MJC £14.95**

Money Matters: An introduction to British Currency, from simple recognition to shopping & change. (ages 2-5 years)**MJC £14.95**

Target Maths: Four games designed to improve mathematical skills, aimed at the National Curriculum. (ages 6-13 years)**MJC £14.95**

HOORAY FOR HENRIETTA (5-12)

Making maths fun - covering the four basic maths operations with 8 skill levels and a Parent section for customisation.....£17.95

HENRIETTA'S BOOK OF SPELLS£17.95

Further information on our Educational range is available in our Educational Supplement - on request

VISA

Remember - prices include VAT & delivery!

Access

Q. Which is the only Amiga magazine solely dedicated to using the Amiga as a serious computer?

A. Amiga Shopper

Q. Which Amiga magazine takes at least 15 pages of each and every issue to answer readers' questions?

A. Amiga Shopper

Q. Which Amiga magazine has monthly columns from some of the Amiga world's most respected writers?

A. Amiga Shopper

Q. Which Amiga magazine gives you twice as much for less than half the price?

A. Amiga Shopper

**AMIGA
SHOPPER**

**ONLY
£1.25**

LATEST ISSUE OUT NOW

CRASHING DEMOS

FROM: HARRY HARRIS, BRISTOL

Although both Coverdisks that I acquired with *Amiga Format* issue 33 are in full working order (work fine on an A500 with 1Mb) the demo of *Myth* crashes on loading and *Vista* does the same when I try to render a picture on my brand new A1500. Is my machine at fault or is there some incompatibility between the A1500 and the A500?



The A1500 (pictured here) was designed to be expanded with more memory, a hard disk and so on. Without these extras it doesn't work so well.

Before I give an answer to that question, I'd like to stress to all our readers who contribute to the Workbench pages to clearly state what their computer configuration is, right down to the last memory expansion and disk drive. It may seem a little bit

Workbench

I can't install software on my new hard drive? How do I sell my programs? **Pat McDonald** answers these and more.

unnecessary, but it's very important if I'm to give you a clear and concise answer.

Now back to the matter in hand, assuming that you are talking about a clean A1500 with absolutely no expansions, the most obvious cause is that the second internal floppy drive is grabbing some memory. It's impossible to disconnect the second drive easily because it's built into the machine. Each and every disk drive connected to an Amiga takes some memory (between 20 and 64K, depending on the type). So an A1500 always has less memory than a machine with only one internal floppy disk drive.

This is certainly enough to crash *Vista* and probably *Myth* as well. Try *Myth* again – it takes a while to decrunch, which can look like it's not working whereas it just takes a minute or so to get up and running.

Also be aware that, because all of the inbuilt one meg of memory on an A1500 is chip RAM (which is same as the A500 Plus) some software will just not work, because it needs fast RAM in order to work. Also take a look at Answerfile on Page 202 for some more information on the tribulations of having 1Mb chip RAM only. Investing in a memory expansion certainly makes sense. What is the point of having all those expansion slots inside the machine if you don't plug anything into them?

HARD TO INSTALL

FROM: DANIEL MORGAN, SIDCUP

I have a 1.3 A500 with a GVP Series II hard drive – this has had 4Mb of RAM on board. I've formatted the hard disk to have one partition, called DH0:, and it has three drawers on it; Games, Utils, and Demos. To help me copy files and set things up I've been using the SID II utility.

I'm having real problems installing software on to it. I tried with *God Father*, making a separate drawer inside the Games drawer called (surprise) *God Father*. However, when I double click on the icon, a requester box comes up asking me to insert *God Father* disk 1.

Not to be put off so easily, I put this line into my hard drive's startup-sequence:

```
Assign GodFather: DH0:Games/God Father
```

I did this for all six disks, but when I rebooted the machine (to get the modified startup-sequence working) it came up with an error message like so:

```
Bad Args
assign failed returncode 20
```

You were almost right. The problem is that the name "God Father" has a space in it – if you use names on the Amiga with spaces on, then Shell becomes a bit trickier to use. Incidentally, try typing the Assign in directly and testing it straightaway – it saves the hassle of a reboot, because getting an Assign right can be quite fiddly. You should find this works:

```
Assign GodFather: "DH0:Games/God Father"
```

Incidentally, the way that the Assign command works is worth explaining. Think of it as a route command. In the above example, after it's been typed into the Shell or is included in a startup-sequence and executed, every time the computer needs a disk called *God Father*, it will instead look in the drawer called *God Father*, which is in a drawer called *Games*, which is on the hard disk (DH0:).

I have plenty of other problems (Shell doesn't work anymore, I can't get *Agatron animations* to work properly, and there are quite a few more games and animations that just don't want to know). How do I get the hard drive to work properly?

What I think you have done is failed to put enough of the files that Workbench needs onto your hard disk. The only file you need to save is the startup-sequence of your hard drive (copy it some place safe first). Then put your Workbench floppy disk into the internal drive of your computer and type:

```
Copy all from DF0: to Sys:
```

WE'RE SCANNIN'

FROM: MARK SENIOR, BARNSLEY

I have decided that I can just about afford an A500 Plus but have a few questions about the Sharp JX300 scanner.

1) Is it really necessary to have a minimum of 4Mb as mentioned in the Pro Scan Lab review in *Amiga Format* Issue 27?

Yes. Colour scans take up lots and lots and lots of memory.

2) Why does the interface and software cost two thirds of the price of the scanner?

Well it's a bit involved, but it comes down to three factors. First, it's a relatively new product with no competition to help force down the price. Second,



The Sharp JX300 is a true flat bed scanner, and requires both a pokey Amiga and a fairly expensive interface board.

a scanner interface, by it's very nature, has to be extremely reliable and have a high transfer rate. Third, it's really aimed at the specialist market – few people can justify the outlay of buying a flatbed scanner, even when it's a relatively cheap one like the JX300.

3) If a screen occupies 4Mb, how do you save it without a hard drive?

You don't. If you're playing around with scanned images, a beefed-up machine and hard drive are vital.

4) Is it possible to use an A500 Plus with Pro Scan Lab or do I need an A1500?

The Pro Scan Lab hardware will not connect to anything other than an A1500, A2000 or A3000. Keep a look-out for the new Epson GT-6000 scanner, an A4 flatbed scanner like the JX-300, though probably much cheaper. It will scan in full colour either straight to disk (meaning you don't need so much RAM) or into *Art Department Pro*. It scans to the parallel port, and so should be A500 compatible.

After that, put the hard drive's startup-sequence back into DH0:s (curiously most of the files needed to run Shell are also in the s directory). Also, the commands BindDrivers and SetPatch must be in your startup-sequence, otherwise strange results will occur – have a look at the standard Workbench startup-sequence to see how they should be used.

And a couple more questions for you: do I need a special Agnus to have 1Mb of chip RAM (I have an 8372A) and how fast do the chips mounted inside the computer have to work? I know that there's a limit of some sort but I don't know what it is.

The 8372A Agnus chip (don't worry about the final A – there was no other version of the 8372) is fine for upgrading to 1Mb of chip RAM. You will need to alter the Setpatch command in the startup-sequence to use it properly though: see later in the text. As for the chip speed, 100ns (nano-second) chips or faster must be used – this is usually written as the last two numbers of a chip's serial number. For instance, AGH25644a-10. An 80ns chip would have AGH25644a-08 instead.

SELL YOUR SOURCE

FROM: NEIL MURPHY, DISS

I have spent the last year writing a computer game. A few weeks ago, I finally finished it and I think that it may just be good enough to release as a commercial product. Only marketing a game seems to be a lot harder than writing one! Please could you clarify a few points:

1) Which software houses are most likely to publish a space game involving frantic action and trading but different to the run-of-the-mill formulas – perhaps a budget software house?

Answering in reverse order, the only true budget software house is (so far as I know) Codemasters. All the others are merely affiliated to full-price software houses. Probably your best approach is to send every software house that publishes similar 'serious' games a cut down, razzmatazz version. Remember, you have about 10 seconds to grab somebody's attention – make the opening as grand and punchy as you like, just to make sure that the software evaluation person keeps looking at your program.

2) Is it possible that if I send my game to a publisher that they will steal my ideas or even my game and give me nothing? If so what measures should I take to prevent this?

Documented cases of this happening are extremely rare. However, every commercial programmer has a favourite horror story of how they were cheated. So it's probably a good idea to mail a copy of the game to yourself, asking the post office to frank it on the seal at the back. When it arrives back at your house, put it somewhere safe. If and when legal difficulties arise, take it to a lawyer.

3) The graphics in my game are not brilliant. Is it likely that a software house would provide professionals to produce better graphics to slot into the final program?

Software houses practically always demand various changes, big and small. It's not just a question of hiring an artist and letting them loose on the game – you are going to have to document the graphics very thoroughly, specifying every single graphic in terms of size, number of colours and what it shows. Only then could an artist hope to achieve any reasonable results in a shortish time.

4) How much should I expect to earn if my game is published? What percentage royalties might I be offered?

That depends on many factors. Proportionally, games programmers probably earn less in the Nineties than they did at the beginning, because the market demands a more professional approach to user friendliness, documentation (you have designed and written the manual, haven't you?) and other factors such as advertising budgets.

You will either be offered a cash payment for all rights to a game (usually a figure between £2,000-£10,000) or a percentage royalty of 10 per cent. Try to take the latter unless it's a very small software house or you really do need the cash up front. The reason is that with a royalty payment you usually keep the copyright and you can keep the game for re-release in future years.

5) If all else fails, is it profitable to release a game as Licenseware?

That depends on what you mean by profitable. If you mean a reasonable rate considering you've spent a year developing the product, forget it. Licenseware authors usually make hundreds of pounds, not thousands. However, it's a relatively new market and there may be Licenseware millionaires yet.

If you do release the program as Licenseware, make sure to do it through a large PD library that already sells such programs – they have the best background to give you the best deal in such cases. Setting up your own licenseware organisation is nearly as involved as setting up a software publishing house.

With licenseware, you are competing directly with the commercial side of the software industry, and they play hard and don't take prisoners.

UPMARKET MACHINES

FROM: A THOMSON, FYVIE

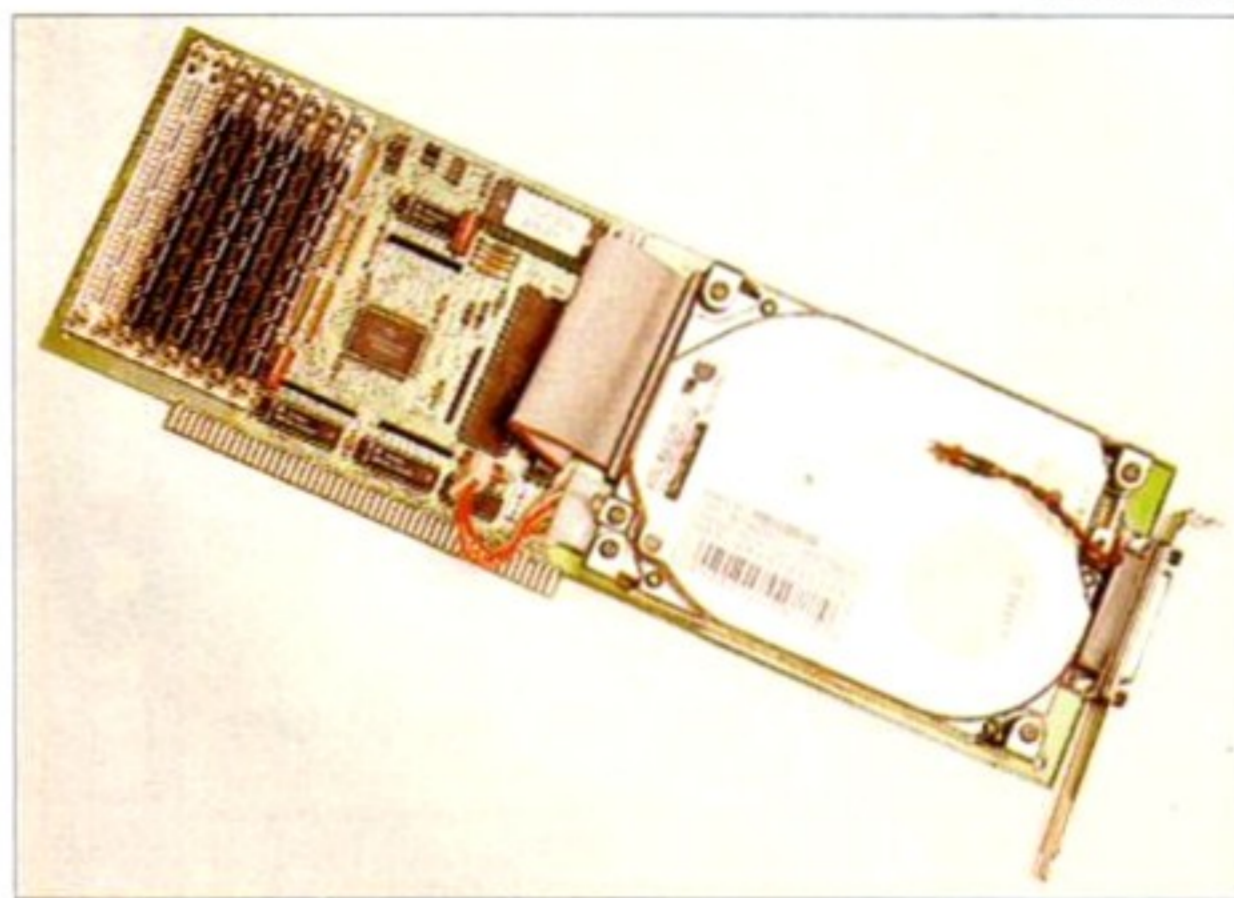

The A1500/A2000 version of the GVP Impact II hard drive is electronically the same as the A500 model, but is cheaper because it has no case.

I currently own a 1.2 A500 but I'm considering for some time replacing it with a 2.04 A1500 and a GVP Series II hard drive, but of course I have a few questions that I hope you can help me with first! Beginning with...

1) Is the A1500 really completely A2000 compatible?

Effectively, yes. The only problem occurs when using the faster types of accelerator board (40-50MHz 68030 or 68040). These often fall over (crash) on computers lower than revision 6.2.

2) Is it, or will it be, possible to upgrade to full A3000 operation and compatibility, using an accelerator (either Microbotics VXL or a GVP 68030 type)?

No. Well, in terms of speed and usability you have the same system (more or less) but you don't have the '32 bit Zorro III' expansion slot of an A3000. This is very specific to the machine, allowing very fast, capable, industrial standard and expensive expansions. In day-to-day usage it would be hard to tell the difference though - Workbench would be as fast or faster than that on an A3000.

3) If the above is possible can I keep low-end Amiga compatibility for games?

Yes. Practically all accelerators sold these days have an off facility, to use the standard 68000 processor rather than the faster accelerated 68020/68030/68040. Plenty of games and PD do not like these expansions, and need a standard system to

run. Many A3000 owners moan that a lot of software doesn't run on their super-duper machines – that's because they can't 'come down' to the level of the A500. The problem does exist on the A1500/A2000 (some software doesn't run) but it's not nearly as bad as the A3000's incompatibility problems with games.

4) A500 hard drives have an on/off switch to disable them in order to run certain software (most often games and PD). Do A1500/A2000 expansions have such a facility or is it not needed?

They don't as standard, although wiring a switch to the autoboot jumper (exactly what's done on an A500 hard drive) would not be a chore for most electronics buffs. Generally it's to preserve memory used by the hard drive – if you have lots of memory (more than 2Mb) then you generally don't need to flick the switch anyway.

5) With a hardware PC emulator (Bridgeboard/KCS/ATOnce) is it possible to partition the hard drive to have a PC only area, or can they use Amiga partitions?

Yes, you can format PC partitions with any of the above, although the Bridgeboard can access Amiga partitions too – very slowly. Get the most up to date software in the case of the ATOnce and KCS board to make a PC partition or two on most popular makes of Amiga hard drive.

NEW LOWER PRICES!

AMIGA PACKS

NEW LOWER PRICES!

OUR SALES LINES (NOT A ANSWERPHONE !!) ARE OPEN FROM 8.00AM TILL 8.00PM - 7 DAYS A WEEK

ALL PRICES INCLUDE VAT. ALL ORDERS OVER £100 ARE SUBJECT TO £5 UK DELIVERY CHARGE. ORDERS OVER £100 RECEIVED BEFORE 2PM ARE USUALLY DESPATCHED THE SAME DAY FOR DELIVERY ON THE NEXT WEEK DAY. ORDERS UNDER £100 ARE SENT 1ST CLASS RECORDED POST. ALL PRODUCTS ARE UK STOCK AND CARRY A FULL 12 MONTH COMMODORE WARRANTY. PLEASE RING US BEFORE ORDERING TO CHECK STOCKS AND CURRENT PRICES.

AMIGA A600 - PHONE TODAY!

- AMIGA A500+ 1MB CARTOON CLASSICS** Amiga A500 computer, supplied with 1MB ram built in, Kickstart V2, expansion to 2MB ram possible via "trap door", mouse, tv modulator, manuals, Workbench V2 etc disks, plus the following top selling software titles : Lemmings, The Simpsons, Captain Planet and Deluxe Paint 3 **£339.00**
- AMIGA A500+ 2MB CARTOON CLASSICS** Amiga A500 computer, supplied with 1MB ram built in and an extra 1MB expansion board (giving a total of 2 megabytes of ram), Kickstart V2, mouse, tv modulator, manuals, Workbench V2 etc disks, plus the following top selling software titles : Lemmings, The Simpsons, Captain Planet and Deluxe Paint 3 **£379.00**
- AMIGA A1500+ BASE** A1500 computer with 1MB ram and now with Kickstart V2 and Workbench V2 software, detachable keyboard, 2 x 3.5" 880k disk drives built in, mouse and all manuals. The Amiga A1500 accepts A2000 peripherals. The A1500 base pack is supplied with no software. Please note that the A1500 does NOT have a modulator. **£499.00**
- AMIGA A1500+ PACK A** consists of A1500+ base pack and the following software : Platinum Works, Deluxe Paint Version 3, Populous, Simm City, Battle Chess, Their Finest Hour (Battle of Britain) and 2 books **£549.00**
- AMIGA A1500+ PACK B** consists of A1500+ base pack and the following software : Platinum Works, Deluxe Paint Version 3, Home Accounts, Elf, Puzznic, Toki and Getting the Most Out Of Your Amiga book **£549.00**

G.V.P Hard Disks

A500 HARD DISKS

GVP Series II 52Mb Hard Disk £379.00
GVP Series II 105Mb Hard Disk £549.00

A1500 HARD DISKS

GVP 52Mb Hard Card £289.00
GVP 120Mb Hard Card £469.00
GVP 200Mb Hard Card £849.00

PLEASE PHONE FOR PRICES ON RAM UPGRADES ETC FOR ANY OF THE ABOVE HARD DISK DRIVES.

Have You Got A V1.3 Amiga?

DO YOU WANT VERSION 2 KICKSTART & WORKBENCH?

If so, we now have in stock the new VERSION 2 UPGRADE KIT. The kit consists of the Kickstart 2 Rom, Workbench 2 software (including the Extras disk and the Fonts disk) and the Workbench 2 full manuals. Easy to fit and requires no soldering.

£ 89.99

Accessories

512K ram expansion + clock £29.99
Colour Monitors PHONE
Compatible external disk drive £59.00
Zy Fi Stereo Speakers £37.50
Squick replacement mouse £14.99
Amiga A500 dust cover £8.99
Mouse Mat £3.50
Cruiser Joystick £8.99

PRINTERS

ATTENTION ALL CITIZEN PRINTER BUYERS !!

CITIZEN PRINTER STARTER PACK. The pack comprises of : 3.5" disk full of printer drivers for the ST, Amiga & PC; 200 sheets of fanfold tractor feed paper; 200 fanfold tractor feed address labels; 5 tractor feed envelopes all for only £12.99.

CITIZEN COLOUR PRINTING KIT. This kit enables you to upgrade either the Swift 9, Swift 24E or 224 to a full colour printer. The kit comes with a colour ribbon. Normally retailing at around £40.00, we are offering, while stocks last, the chance to buy this colour kit for only £19.99.

Citizen 120D+ (9-pin, 144 cps draft, 30 cps NLQ) £124.99
Citizen Swift 9 (9-pin, 192 cps draft, 48 cps NLQ) £184.99
Citizen 224 (24-pin, 192 cps draft, 64 cps LQ) £224.99
Citizen Swift 24E (24-pin, 216 cps draft, 72 cps LQ) £279.99
Citizen Swift 24X (24-pin, 15" carriage) £379.99
Citizen Pro Jet (inkjet, 360 cps draft, 120 cps NLQ, 300 dpi) £409.99

NEW LOWER PRINTER PRICES !!

Star LC20 Mono (9-pin, 180 cps draft, 44 cps NLQ) £134.99
Star LC200 Colour (9-pin, 180 cps draft, 45 cps NLQ) £194.99
Star LC24-20 Mono (24-pin, 210 cps draft, 64 cps LQ) £204.99
Star LC24-200 Mono (24-pin, 200 cps draft, 67 cps LQ) £249.99
Star LC24-200 Colour (24-pin, 200 cps draft, 67 cps LQ) £274.99
Star SJ-48 (inkjet, 166 cps, portable, 360 dpi) £259.00

Canon BJ10 EX Bubble Jet (ink jet, Epson compatible) £285.00
Hewlett Packard DeskJet 500 (ink jet, 3 pages per minute) £389.00
Hewlett Packard Deskjet 500 Colour (NEW! full colour inkjet) £619.00

SOFTWARE SPECIAL OFFERS

LEMMINGS

£ 7.99

SIMPSONS

£ 7.99

CPT PLANET

£ 7.99

D PAINT 3

£ 19.99

Make your Amiga A500+ 2MB

If you want to expand you Amiga A500 Plus to a total of 2MB then why not fit the new 1Mb Ram Board? This extra ram will unleash the full graphics capabilities of the A500 Plus and is ideal for many other applications such as sound sampling, data storage etc... It's simple to fit, without any modification, and will not invalidate your computers warranty.

£49.99

FOR USE WITH THE A500 PLUS ONLY

Kickstart Rom Switcher

with V1.3 Roms

Some older software will not run on the new Amiga A500 Plus with Kickstart V2.04 Rom but they do run on the older V1.3 A500s.

We are now stocking the Phoenix Rom Switcher which means, once installed, you can switch between Kickstart 1.3 and 2.04 giving you all the benefits of both Amigas and solving those incompatibility problems.

The Phoenix Rom Switcher can be easily installed to the A500 Plus and comes supplied with Kickstart V1.3 Roms. Included in the kit is a microswitch which can be mounted virtually anywhere to enable toggling between the two Rom versions.

£49.99

FOR USE WITH THE A500 PLUS ONLY

IF YOU WISH TO ORDER WITH US, THEN PLEASE SEND YOUR CHEQUES, BANKERS DRAFTS, POSTAL ORDERS, CASH ETC TO OUR MAIL ORDER ADDRESS (PLEASE MAKE CHEQUES PAYABLE TO BEST PRICES) OR RING OUR MAIL ORDER HOTLINE ANY TIME BETWEEN 8.00AM AND 8.00PM, 7 DAYS A WEEK. (OUR LINES ARE PERSONALLY MANNED - THIS IS NOT AN ANSWERPHONE) AND USE YOUR CREDIT CARD. ALL ORDERS OVER £100 SUBJECT TO £5 DELIVERY CHARGE, OR ALTERNATIVELY VISIT OUR SHOP.

SHOWROOM & SHOP

CHIPS COMPUTER CENTRE, 53 RUGBY ROAD, WORTHING, WEST SUSSEX, BN11 5NB.

TEL : (0903) 700804.

OPENING : MON TO FRI 10AM TO 6PM. SAT 9.30AM TO 5.30PM

FINANCE / CREDIT FACILITIES (SHOP ONLY).

PART EXCHANGE CONSIDERED (SHOP ONLY).

NEW AND USED ST, AMIGA & PC EQUIPMENT ON DISPLAY

ALL TYPES OF SOFTWARE (BUSINESS / LEISURE / EDUCATIONAL).

REPAIRS UNDERTAKEN. TRAINING. INSTALLATION. ON-SITE WARRANTIES.



MAIL ORDER SALES

BEST PRICES (DEPT AF), 53 RUGBY ROAD, WORTHING, WEST SUSSEX, BN11 5NB.

TEL : (0903) 700714.

OPENING : 7 DAYS A WEEK 8AM TO 8PM

ALL PRICES INCLUDE VAT. ALL ORDERS OVER £100 ADD £5 FOR NEXT WEEKDAY

COURIER DELIVERY. ORDERS UNDER £100 ARE SENT BY POST.

CREDIT CARDS ARE SUBJECT TO ADDRESS VERIFICATION BY CARD ISSUERS.

GOODS USUALLY SENT OUT THE SAME DAY WHEN

CLEARED PAYMENT IS RECEIVED BEFORE 2PM.

PERSONAL CHEQUES REQUIRE 7 DAY CLEARANCE.

All prices include 17.5% VAT. Free delivery ONLY on orders under £100. All prices / specifications / special offers subject to change without notice.



EAGLE SOFTWARE

118a Palmers Road
New Southgate
LONDON N11 1SL.

(10 am - 6pm 6 days)

Tel: 081-361 2733/5730

(2733 Faxline after 6pm)

FREE
MYSTERY
GAME
WITH ORDERS
OVER £50



ST & AMIGA BUDGET TITLES UNDER £10

1 Meg Cricket (Amiga only)	£4.99	Dragon Ninja	£6.99	Platoon	£5.99
3 Stooges	£6.99	Fantasy World Dizzy	£5.99	Predator	£6.99
3D Pool	£6.99	F16 Combat Pilot	£7.99	Rambo III	£6.99
Afterburner	£6.99	Gauntlet II	£6.99	Red Heat	£6.99
Altered Beast	£6.99	Ghostbusters II	£6.99	Resolution 101	£6.99
Arkanoid (Amiga only)	£4.50	Ghouls'n'Ghosts	£6.99	Road Blaster	£6.99
Arkanoid II	£6.99	Hard Drivin'	£6.99	Rocket Ranger	£8.99
Baal	£5.99	Head over Heels	£6.99	R-Type	£6.99
Barbarian	£5.99	Hitch Hiker's Guide to Galaxy	£7.99	Run The Gauntlet	£6.99
Barbarian II	£6.99	Hong Kong Phooey	£6.99	Shadow of the Beast (Amiga)	£6.99
Batman Caped Crusader	£6.99	IK+	£6.99	Sherman M4	£6.99
Batman The Movie	£6.99	Impossible Mission II	£6.99	Shinobi	£6.99
Beach Volley	£6.99	James Pond	£6.99	Shuffle Puck Cafe	£6.99
Blood Money	£6.99	Jet Set Willy	£7.99	Speedball	£7.99
Cabal	£6.99	Kid Gloves	£5.99	Strike Force Harrier	£6.99
California Games	£6.99	Last Ninja II	£6.99	Stunt Car Racer	£6.99
Carrier Command	£8.99	Licence to Kill	£5.99	Super Hang On	£6.99
Celica GT4 Rally	£6.99	Lombard RAC Rally	£6.99	Switchblade	£6.99
Centrefold Squares	£6.99	Manic Miner	£7.99	Teenage Mutant Turtles	£6.99
Cloud Kingdom	£6.99	Michael Jackson Moonwalker	£6.99	Thunderstrike	£6.99
Colossus Chess	£6.99	Moonshine Racers	£6.99	Toobin'	£6.99
Conflict in Europe	£7.99	New Zealand Story	£6.99	TV Sports Football	£7.99
Continental Circus (ST only)	£4.99	Ninja Rabbits	£5.99	Vigilante	£6.99
Defender of the Crown	£7.99	Nitro	£7.99	War Zone	£6.99
Def of the Earth	£6.99	North & South	£6.99	Waterloo	£6.99
Deluxe Strip Poker	£6.99	Out Run	£6.99	Wings of Fury (Amiga only)	£6.99
Double Dragon 1 or II	£6.99	Operation Wolf	£6.99	Wizball	£4.99
				WC Leaderboard	£6.99
				Xenon II	£7.99

TOP TITLES	ST	AMIGA
Half Meg Upgrade + Clock	N/A	£25.99
World Series Cricket	N/A	£16.99
3D Construction Kit	£29.99	£36.99
A320 Airbus	£26.99	£26.99
Abandoned Places	£19.99	£19.99
Addams Family	£16.99	£16.99
Advantage Tennis	£16.99	£16.99
Agony	£15.99	£15.99
Air Support	£15.99	£15.99
Alien Storm	£16.99	£16.99
Alpha Waves	£16.99	£16.99
Altered Destiny	N/A	£21.99
Another World	£18.99	£18.99
AMNIOS	£15.99	£12.99
Amos (Easy)	N/A	£23.99
Amos 3D	N/A	£23.99
Amos Compiler	N/A	£19.99
Amos The Creator	N/A	£36.99
Aquaventura	£15.99	£15.99
Armourgeddon	£15.99	£15.99
Armourgeddon Upgrade	£10.99	£10.99
A.T.A.C.	£23.99	£23.99
ATOMINO	£12.99	£12.99
AWSOME	£12.99	£12.99
B17 Flying Fortress	£23.99	£23.99
Back to the Future III	£10.99	£10.99
Back to the Golden Age	£16.99	£16.99
BARBARIAN II (Psyg)	£12.99	£15.99
Bard's Tale III	N/A	£16.99
B.A.T. II	£22.99	£22.99
Battle Chess II	£16.99	£16.99
Battle Command	£15.99	£15.99
BATTLE HAWKS 1942	£8.99	N/A
Battle Isle	£18.99	£18.99
BATTLE MASTER	£19.99	£11.99
Battle Squadron	N/A	£7.99
Betrayal	N/A	£8.99
Big Run	£16.99	£16.99
Billiard Simulator II	£16.99	£16.99
Bike GP	N/A	£15.99
Birds of Prey	£23.99	£23.99
Blue Max	£19.99	£19.99
Blues Brothers	£16.99	£16.99
Boston Bomb Club	£16.99	£16.99
Buck Rogers	£19.99	£19.99
Cadaver	£16.99	£16.99
Cadaver - the pay off	£10.99	£10.99
Captive	£15.99	£12.99
Cardiax	£17.99	£17.99
CARTHAGE	£15.99	£12.99
Carve Up	£15.99	£15.99
Chaos Engine	£16.99	£16.99
Chaos Strike Back	£16.99	£16.99
Champion of the Raj	£9.99	£9.99
Chase HQ	£6.99	£6.99
Chase HQ II	£14.99	£14.99
Chuck Rock	£16.99	£16.99
Cisco Heat	£15.99	£11.99

TOP TITLES	ST	AMIGA
C.Y.'s Air Combat	£20.99	£20.99
Cohort	£20.99	£20.99
Combo Racer	£6.99	£6.99
Cover Girl Poker	£16.99	£16.99
Covert Action	£23.99	£23.99
Crazy Cars III	£21.99	£21.99
Crime Wave	£16.99	£10.99
Cruise for a Corpse	£17.99	£17.99
Darkman	£15.99	£15.99
Days of Thunder	£15.99	£8.99
Deliverance	£15.99	£15.99
Demoniak	£19.99	£19.99
Deuterios	£14.99	£14.99
Devious Designs	£16.99	£16.99
Di'Generation	£16.99	£16.99
Disciples of Steel	£17.99	£17.99
Double Dragon III	£16.99	£16.99
Dr Dooms Revenge	£9.99	N/A
Dyna Blast	£20.99	£20.99
ELF	£15.99	£15.99
Elvira Mistress of Dark	£21.99	£21.99
Elvira II Jaws of Cerberus	£23.99	£23.99
Elvira the Arcade	£16.99	£16.99
Epic	£15.99	£15.99
Eye of the Beholder	N/A	£19.99
Eye of the Beholder II	N/A	£20.99
F14 Tom Cat	£18.99	£18.99
F15 Strike Eagle II	£23.99	£23.99
F117A Stealth Fighter	£21.99	£21.99
F19 Stealth Fighter	£19.99	£19.99
F29 Retaliator	£15.99	£15.99
Face Off - Ice Hockey	£15.99	£15.99
Falcon III	£23.99	£23.99
Fantastic Voyage	£23.99	£23.99
Fate of Atlantis (Adventure)	N/A	£17.99
Fate of Atlantis (Arcade)	N/A	£17.99
Federation of Free Traders	£6.99	£6.99
Final Blow	£16.99	£16.99
Final Fight	£16.99	£16.99
First Samurai/MgaLoMania	£20.99	£20.99
Flight of the Intruder	£16.99	£22.99
Floor 13	£19.99	£19.99
Football Crazy	£16.99	£16.99
Future Baseball	£16.99	£16.99
Fuzzball	N/A	£13.99
G-Loc R360	£16.99	£16.99
Gauntlet III	£16.99	£16.99
Global Effect	£16.99	£16.99
Godfather	£18.99	£18.99
Gods	£16.99	£16.99
Golden Axe	£6.99	£6.99
Golden Shot	£16.99	£16.99
Graham Gooch Cricket	£21.99	£21.99
Graham Taylor	£19.99	£19.99
Grand Prix (Formula 1)	£23.99	£23.99
Gunship 2000	£21.99	£21.99
Hard Drivin II	£15.99	£15.99
Harlequin	£16.99	£16.99

TOP TITLES	ST	AMIGA
Harpoon (1 Meg)	£19.99	£19.99
Heart of China	£24.99	£24.99
Heimdall	£23.99	£23.99
Hero's Quest (Gremilin)	£16.99	£16.99
Hill Street Blues	£15.99	£15.99
Home Alone	N/A	£23.99
Hook	£15.99	£15.99
Hudson Hawk	£15.99	£15.99
Hunter	£15.99	£15.99
I. Bothams Cricket	£19.99	£19.99
Indy Heat	£16.99	£16.99
Ivanhoe	£6.99	£6.99
Jack Unlimited Clipart	N/A	£10.99
Jaguar XJ220	£21.99	£21.99
Jahangir Khan's Squash	£8.99	£8.99
Jimmy White's Whirlwind	£19.99	£19.99
John Barnes (1 Meg)	£16.99	£16.99
John Maden's Football	£16.99	£16.99
Kick Off II (1 Meg)	£15.99	£15.99
Kick Off II (.5 Meg)	N/A	£14.99
Kick Off Winning Tactics	£9.99	£9.99
Kid Gloves II	£16.99	£16.99
Killing Cloud	£11.99	£11.99
KILLING GAME SHOW	£15.99	£12.99
Kings Quest IV	£14.99	N/A
Kings Quest V	£26.99	£26.99
Knight Mare	£16.99	£16.99
Knight of the Sky	£23.99	£23.99
Last Ninja III	£16.99	£16.99
Leander	£15.99	£15.99
Leisure Suit Larry II	£14.99	£25.99
Leisure Suit Larry III	£25.99	£25.99
Leisure Suit Larry V	£26.99	£26.99
Lemmings	£15.99	£15.99
Lemmings II	£15.99	£15.99
Lemmings - Data Disk	£13.99	£13.99
Lemmings - Stand Alone	£15.99	£15.99
Life and Death II	£20.99	£20.99
Lord of the Rings	N/A	£20.99
Lost Patrol	£15.99	£15.99
Lotus Esprit	£15.99	£15.99
Lotus Turbo Challenge II	£16.99	£16.99
M1 Tank Platoon	£19.99	£19.99
Magic Garden	£16.99	£16.99
Magic Pockets	£15.99	£15.99
Man Utd. Europe	£15.99	£15.99
M. Dika Ultimate Football	£18.99	£18.99
Megatraveller II	£20.99	£20.99
Megatwins	£16.99	£16.99
Mercenary III	£20.99	£20.99
Merchant Colony	£20.99	£20.99
Microprose Golf	£23.99	£23.99
Midnight Resistance	£6.99	£6.99
Midwinter II	£23.99	£23.99
Mig 29 Fulcrum	£21.99	£21.99
Mig 29M Super Fulcrum	£19.99	£19.99
Might of Magic III	N/A	£19.99
Moonfall	£15.99	£15.99
Moonstone	£21.99	£21.99
Monkey Island	£15.99	£15.99
Monkey Island II	N/A	£20.99

TOP TITLES	ST	AMIGA
Mystical	£15.99	£15.99
Myth	£24.99	£24.99
Narc	£15.99	£15.99
Navy Seals	£15.99	£15.99
Nebulus II	£15.99	£15.99
Neighbours	£16.99	£16.99
Nightshift	£10.99	£16.99
ORBITUS	£12.99	£12.99
Operation Thunderbolt	£6.99	£6.99
Ork	£15.99	£15.99
Outrun Europa	£16.99	£16.99
Pacific Islands(T.Yankee II)	£20.99	£20.99
Pang	£15.99	£15.99
Paperboy II	£16.99	£16.99
Parasol Stars	£15.99	£15.99
Pegasus	£16.99	£16.99
PGA Golf Tour +	N/A	£20.99
PGA Courses Disk	N/A	£10.99
Pinball Dreams	N/A	£15.99
Pitfighter	£16.99	£16.99
Plotting	£15.99	£15.99
Populous II	£20.99	£20.99
Predator II	£9.99	£9.99
Prince of Persia	£15.99	£15.99
Puzznic	£15.99	£15.99
QUEST AND GLORY	£20.99	£20.99
Race Drivin'	£19.99	£19.99
Railroad Tycoon	£24.99	£24.99
Rainbow Islands	£6.99	£6.99
R.B.I. 2 Baseball	£20.99	£20.99
Realms	£20.99	£20.99
Red Baron	£23.99	£23.99
Red Zone	£15.99	£15.99
Renegade (Coin-op Hits)	£6.99	£6.99
Rise of the Drago	N/A	£24.99
Robin Hood	£16.99	£16.99
Robocod	£15.99	£15.99
Robocop	£6.99	£6.99
Robocop II	£14.99	£14.99
Robocop III	£15.99	£15.99
Rod Land	£16.99	£16.99
Rollin' Ronny	£15.99	£15.99
R-Type II	£16.99	£16.99
Rubicon	£15.99	£15.99
Rugby World Cup	£15.99	£15.99
R.V.F. Honda	£6.99	N/A
Secret of the Silver Blues	£21.99	£21.99
Secret Weapon Luftwaffe	£19.99	£19.99
Shadowlands	£20.99	£20.99
SHADOW OF BEAST II	£12.99	£12.99
Shadow Sorcerer	£19.99	£19.99
Shadow Warrior	£15.99	£15.99
Shuttle the Sim	£29.99	£29.99
Silent Service II	£23.99	£23.99
Sim Ant	£15.99	£15.99
Sim Earth	£20.99	£20.99
Simpsons	£15.99	£15.99
Ski or Die	£16.99	£9.99
Smash TV	£15.99	£15.99
Space 1889	£20.99	£20.99
Space Ace II	N/A	£33.99

TOP TITLES	ST	AMIGA
Space Gun	£15.99	£15.99
Space Crusade	£16.99	£16.99
Space Quest I,II,III,or IV	N/A	£19.99
Special Forces	£23.99	£23.99
Speedball II	£15.99	£15.99
Spirit of Excalibur	£20.99	£20.99
Starglider II	£6.99	£6.99
Star Trek V	£15.99	£16.99
Starfighter II	N/A	£16.99
Stratego	£17.99	£17.99
Steel Empire	£20.99	£20.99
Strider II	£15.99	£15.99
Strike Fleet	£17.99	£17.99
Supaplex	£6.99	£6.99
Super Cars II	£15.99	£15.99
Super Hero	N/A	£15.99
Super Off Road	£8.99	£8.99
Super Space Invaders	£16.99	£16.99
Supremacy	£20.99	£18.99
Suspicious Cargo	£16.99	£16.99
Swap	£16.99	£16.99
Switch Blade II	£15.99	£15.99
Terminator II	£15.99	£15.99
Test Drive III	£15.99	£15.99
Their Finest Hour	£19.99	£19.99
Their Finest Mission	£12.99	£12.99
The Manager	£16.99	£16.99
Thunderhawk AH-73M	£21.99	£21.99
Thunder Jaws	£16.99	£16.99
Tip Off	£16.99	£16.99
Titus the Fox	£16.99	£16.99
Toki	£14.99	£14.99
Total Recall	£15.99	£15.99
Turrican II	£9.99	£9.99
Twilight 2000	£23.99	£23.99
Ultima Martian Dreams	£20.99	£20.99
Ultima Underworld	£20.99	£20.99
Ultima V	£19.99	£19.99
Ultima VI	£20.99	£20.99
ULTIMA VII	£20.99	£20.99
ULTIMATE RIDE	£10.99	£10.99
UMS II	£23.99	£23.99
Under Pressure	£17.99	£17.99
UnReal	£16.99	£16.99

TRILOGIC HAVE
BEEN MAILORDER
SPECIALISTS FOR
OVER 8 YEARS.

AMIGA SUPERMARKET

Official govern-
ment & educational
establishment
orders welcome.

DESK TOP VIDEO PERIPHERALS

VIDI The Complete Solution	£139.99
VIDI	£89.99
RGB SPLITTER Rombo Electronic type	£57.99
ROCGEN GENLOCK SAVE LLLs	£99.99
ROCGEN PLUS GENLOCK	£149.99
FRAMEGRABBER	£519.99
SUPERPIC - Colour Digitiser & Genlock	£584.99
SUPERPIC ANIMATE	£684.99
COLOURPIC colour digitiser	£484.99
COLOURPIC ANIMATE	£589.99
CABARET FOR COLOURPIC/SUPERPIC	£28.99
CABARET PLUS	£87.99
DIGIVIEW GOLD the best with a camera	£99.99
RENDALE 8802 GENLOCK	£149.99
RENDALE SUPER 8802 SVHS GENLOCK	£499.99
HITACHI MONO CAMERA LOW PRICE	£179.99

EMULATORS, INTERFACES, MEMORY CARDS & SPARES

KICKSTART 1.3 ROM	£29.99
KICKSTART 2 ROM	£77.99
AMIGA 500+ ROM SWITCH roms extra	£24.99
FATTER AGNUS 8372A	£69.99
SUPER DENISE	£39.99
GARY	£31.99
8520A I/O chip	£15.99
1500/2000 8MEG CARD unpop uses simms	£79.99
ST506 CONTROLLER FOR A500	£79.99
1500/2000 SCSI DRIVE CONTROLLER	£89.99
1500/2000 IDE DRIVE CONTROLLER	£84.99
A500 SCSI CONTROLLER & HOUSING	£129.99
A500 IDE CONTROLLER & HOUSING	£119.99
A520 MODULATOR	£29.99
UPRATED A500 POWER PACK	£44.99
KCS PC BOARD v3 + MSDOS 4	£204.99
KCS WITHOUT MSDOS	£189.99
KCS 2000 PC BOARD ADAPTOR	£64.99
AT ONCE + 16MHz PC EMULATOR	£199.99
256*4 CMOS D RAMS each £4.25 or £33/meg	
1meg * 9 SIMMS 70 or 80 ns	£37.99
23 WAY PLUG & COVER solder type	£2.99
23WAY SOCKET & COVER solder type	£2.99
AMIGA INTERNAL replacement drive	£69.99
MAINS SUPPRESSOR BLOCK 4WAY	£12.99
3.5" DISK DRIVE HEAD CLEANER	£4.99
4 JOYSTICK ADAPTOR	£8.99
PC ANALOGUE JOYSTICK ADAPTOR	£9.99

MICE, JOYSTICKS, SCANNERS, TRACKBALLS & CDTV ACCESSORIES

SPEED MOUSE	£15.99
NAKSHA MOUSE + OPERTN STEALTH	£24.99
CDTV KEYBOARD - BLACK	£49.99
CD TV TRACKBALL CONTROLLER	£77.99
ZYDEC AMIGA SCANNER	£99.99
CRP A4 GRAPHICS TABLET	£329.99
GRAVIS MOUSE STICK CONTROLLER	£65.99
DELTA 3A ANALOGUE JOYSTICK	£14.99
ZIPSTICK AUTOFIRE	£12.99
PRO 5000 COMBAT	£9.99
PRO 5000 STAR	£13.99
QUICKJOY SUPERSTAR	£13.99
QUICKSHOT TOPSTAR	£19.99
MEGA STAR HEAVY DUTY JOYSTICK	£26.99
NAVIGATOR AUTOFIRE JOYSTICK	£13.99
SPEEDKING AUTOFIRE	£11.99
QUICKJOY PYTHON	£10.99
ZYDEC AMIGA TRACKBALL	£34.99
MARCONI TRACKERBALL	£49.99
PHAZER LIGHT GUN PACK	£34.99
OPTICAL MOUSE	£38.99

NAKSHA AMIGA MOUSE +
OPERATION STEALTH £24.99

DIGIVIEW MEDIASTATION DIGIVIEW + DIGIPAIN 3 + ELAN PERFORMER SPECIAL OFFER - £134.99

AMIGA BOOKS

^ = PRICE INCLUDES PROGRAM DISK

AMIGA FOR BEGINNERS	£16.99
AMIGA BASIC INSIDE & OUT	£18.45
AMIGA SYSTEM PRO GUIDE	£32.45
AMIGA ADVANCED SYSTEM PROGRAMMERS GUIDE	£32.45
AMIGA DISK DRIVES 1 & O	£27.95
AMIGA DOS INSIDE OUT	£19.99^
AMIGA PRINTERS 1 & O	£31.95
AMIGA DESKTOP VIDEO	£23.95
AMIGA 3D GRAPHICS	£17.95
MAKING MUSIC ON AMIGA	£27.99^
AMIGA GRAHICS I&O	£31.95
AMIGA MACHINE LANGUA	£14.45
AMIGA C FOR BEGINNERS	£16.99
AMIGA C FOR ADVANCED PRORAMMERS	£27.99
AMIGA DOS MANUAL	£19.95
KIDS & THE AMIGA	£15.95
BEST AMIGA TRICKS & TIPS	£27.45^
MAPPING THE AMIGA MACHINE LANGUAGE FOR BEGINNERS	£19.95
ELEMENTARY AMIGA BASIC	£14.95
ADVANCED AMIGA BASIC	£16.95
PROGRAM DESIGN TECHNIQUES ON THE AMIGA	£16.95
USING AREXX ON AMIGA	£27.99
FIRST BOOK OF THE AMIGA	£16.95
AMIGA ASSEMBLY LANGUAGE PROGRAMMING	£14.45
USING DELUXE PAINT	£19.95
AMIGA VISION HANDBOOK	£23.45
THE IMAGINE COMPANION	£24.95^
HARDWARE REF MANUAL	£21.95
68000 ASSEMBLY LANGUAGE PROGRAMMING	£24.95
AMIGA ROM KERNEL REFERENCE BOOKS - 3 AVAILABLE - each	£28.95
DELUXE PAINT VIDEO	£19.99
SUPERBASE - THE BOOK I&O = ABACUS 'INSIDE & OUT' SERIES.	£11.49

SEAL n TYPE KEYBOARD SKIN.

Moulded to cover each key, but flexible enough to type through.
AMIGA 500 & PLUS (state which when ordering please) £12.49
1500/2000 £12.99

ANTISTATIC DUST COVERS

AMIGA 500 & 500 Plus	£4.99
AMIGA 1500/2000 2PIECE	£12.99
8833/1084 MONITOR	£7.99
SWIFT 9, LC200 PRINTER	£7.99

OTHERS TYPES AVAILABLE

CYCLONE 1 ADAPTOR £12.99

DISKS & DISK BOXES

250 SIZE BANK BOX	£24.99
150 SIZE POSSO BOX	£19.99
40/50 SIZE LOCKABLE BOX	£6.99
20 SIZE DISK HOLDER	£2.99
80 SIZE LOCKABLE BOX	£7.99
100 SIZE LOCKABLE BOX	£8.99
TDK BRANDED DISKS PACK OF 10 DS/DD INCLUDING LABELS.	£7.99

SALES: 0274-691115

AMIGA SUPERMARKET

TRILOGIC,
UNIT 1, DEPT AF6,
253 NEW WORKS RD,
BRADFORD, BD12 0QP

We're easy to find, just 1.5 miles from the M62. Directions. Leave M62 at junction 26, take A638 to Bradford, uphill, after about 1.5 miles, turn left just over a railway bridge. After 1/4 mile, look for us opposite a Royal Mail letterbox. FAX 0274 - 600150

HOW TO ORDER. ALL PRICES INCLUDE VAT Commodore dealer since 1894

BY PHONE: Simply phone us with your Access or Visa number (inc Connect & bank debit cards) for sameday despatch. (if goods in stock - most are, & orders are received before 3pm). You are not charged until the goods are despatched.
BY MAIL: Send cheque, (made payable to TRILOGIC), POs, or your c/ card number & expiry date, order details, & name, address & phone number to the address above.
POSTAGE: Please add nominal post & packing charge of just £1 to orders under £100, or £2 to orders over £10.
OPTIONAL EXPRESS DELIVERY - Recommended for orders over £50.00 in value. 2-3 day delivery - add £3.50 Next Working Day Delivery - add £5.50 (Please allow 2-3 days for remote areas, UK mainland only). Weekday delivery only.
EXPORT ORDERS WELCOME. PLEASE ADD £3.50 POSTAGE PER ORDER.
CALLERS MOST WELCOME: Open Mon-Fri 8 till 6, Sat 8-4pm.
Please phone to check availability before calling.

EDUCATIONAL COMPENDIUM 6

SPECIAL BOXED SET COMPRISING:
KIDS TYPE,
WEATHER WATCHER,
CALENDAR QUIZ,
WORDS & NUMBERS,
GAME SET & MATCH
WHAT IS IT WHERE IS IT?

NOW ONLY
£37.99

X COPY

PROFESSIONAL
Latest version - £33.99 complete
NB. Making backups without the permission of the copyright holder is illegal.
OTHER DISK UTILITIES
ACTION REPLAY FOR A500 £57.99
ACTION REPLAY FOR 2000 £67.99
QUARTERBACK £38.99
DISKMASTER £29.99

LOOK OUT FOR
LOWER PRICES ON
MANY ITEMS

MOUSE / JOYSTICK PORT SWITCH NOW £12.99**

- * Has sockets for mouse & joystick.
- * Push button selects mouse or joystick.
- * Uses no power unlike other types.
- * Compatible with many dongles.
- * Saves wear & tear on mouse port.

SUPER-Fi ONE STEREO SYSTEM

- * POWERFUL 12 watts / CHANNEL.
- * COMPACT BOOKSHELF CABINET
- * 3" WOOFER + 1" TWEETER
- * BASS REFLEX PORT
- * 30Hz - 20kHz RESPONSE
- * BUILT-IN MAINS POWER UNIT
- * REMOTE VOLUME CONTROL.

SPECIAL OFFER PRICE
ONLY £34.99 >

SOUND BLASTER	£44.99
ZYFI	£34.99**

SUPER-Fi TWO STEREO SYSTEM

- * MASSIVE 20 watts /channel.
- * BASS, TREBLE & VOLUME CONTROLS
- * 4" WOOFER, 2" TWEETER
- * BASS REFLEX PORT boosts low frequencies
- * MAINS POWERED - no separate psu
- * THE ULTIMATE SOUND SYSTEM FOR COMPUTERS, NICAM VCRs, SATELLITE SYSTEMS ETC. Leads supplied

ONLY £59.99

MIDI INTERFACE 2

Our unique 5 port Midi interface 2 has In, Out & Thru sockets plus two additional switchable out/thru sockets for ingenious versatility. Complete with free midi lead. Fully compatible with Sequencer One, Music X, Deluxe Music, Tiger Cub, Bars & Pipes etc.
NOW ONLY £26.99 >
MIDI 2+ MUSIC X Junior £59.99**
Extra Midi lead 1.2m £1.49
Extra Midi lead 3m £1.99

SAMPLER 2

Our Superb sounding STEREO SAMPLER 2 uses a state of the art A/D chip which samples so fast, it captures every detail of the sound. Easily adjusted level control, connecting lead & free stereo sampling software. Fully compatible with all popular sampling software. NOW ONLY £37.99 >
Special offer.
Sampler 2 & Audition 4 £69.99

> = PRICE CUT ** = LIMITED OFFER
BARGAIN BASEMENT.

GFA BASIC 3.5	£9.99
PHOTON PAINT 2	£12.99
SUPERBASE PERSONAL 2	£29.99
10 STAR GAMES PACK	£24.99
20 SIZE DISK BOX	£2.99
STEREO HEADPHONE AMP	£14.99

SOFTWARE SUPERBUYS

ALL SOFTWARE IS UK SOURCED.

ADVANTAGE	£69.99 >
AMI ALIGNMENT	£29.99 >
AMAS 2	£89.99
AMIGA VISION	£89.99**
AMOS	£34.99
AMOS 3D	£25.99
AMOS COMPILER	£22.99
ART DEPARTMENT	£49.99
ART DEPARTMENT PRO	£149.99 >
ASSEMPRO	£59.99
A TALK III	£39.99
AUDITION 4	£37.49
AUDIOMASTER 4	£49.99 >
AUDIO ENGINEER	£169.99
BARS & PIPES	£99.99 >
BBC EMULATOR	£29.99**
BROADCAST TITLER 2	£167.99
CAN DO 1.6	£72.99**
CASH BOOK CONTROLLER	£52.49
CROSS DOS	£21.99
DAY BY DAY	£22.49
DELUXE PAINT 4	£57.99
DELUXE MUSIC	£49.99
DELUXE VIDEO 3	£74.99
DEVPAC 3 - new version	£51.99
DG CALC	£29.99
DIGIPAIN 3	£39.99
DIRECTORY OPUS	£29.99
DISK MASTER	£29.99 >
DISK MASTER 2	£49.99
DISNEY ANIMATION STUDI	£59.99**
DOCTOR AMI	£29.99
DR TS TIGER CUB	£49.99 >
DR TS KCS LEVEL II	£199.99 >
ELAN PERFORMER 2	£44.99
E TYPE	£29.99
EXCELLENCE	£59.99
FINAL COPY	£54.99**
FLOW v3.0	£54.99**
FLIGHT SIMULATOR II	£29.99
FLIGHT SIM SCENERY DISKS	£16.99
FONT GRABBER	£37.49
GB ROUTE PLUS	£59.99
GFA BASIC Special offer	£9.99**
GOLD DISK OFFICE	£74.99 >
HIGH SPEED PASCAL	£74.99
HISOFT BASIC	£47.99
HISOFT BASIC PROFESS	£
HOME ACCOUNTS 2	£39.99
HOMEBASE	£24.99
HYPERBOOK	£44.99
IMAGINE 2	£199.99
IMAGINE COMPANION	£24.95
INFOFILE	£29.99**
INTROCAD	£31.99 >
INTROCAD PLUS	£74.99**
KINDWORDS	£37.49
LATTICE C v5	£159.99
MACRO 68000 ASSEMBLER	£39.99
MAILSHOT PLUS	£37.49
MEDIA SHOW	£51.99
MICRONAV FLIGHT SIM	£99.99
MUSIC X v1.1	£54.99**
MUSIC X JUNIOR	£39.99**
PAGESTEAM 2.1	£139.99**
PAGE SETTER 2	£44.99
PEN PAL	£54.99*
PERSONAL TAX PLANNER	£29.99
PERSONAL FINANCE MANG	£23.99
PIXMATE	£34.99
PROFESSIONAL CALC	£139.99
PRODATA	£74.99**
PROFESSIONAL DRAW 2	£94.49
PROFESSIONAL PAGE 2	£139.99
PROFESSIONAL PAGE 3	£167.99
PROTEXT v5.5	£99.99**
PRO VIDEO PLUS	£174.99
PROWRITE v3.2	£79.99**
QUARTERBACK	£38.99 >
QUARTERBACK TOOLS	£44.99 >
QUARTET	£34.99
SCALA 500	£74.99
SCRIBBLE PLATINUM	£37.49
SCULPT 3DXL	£89.99
SCULP ANIMATE 4D JNR	£79.99
SEQUENCER 1+	£phone
SONIX	£33.49
SOUNDMASTER	£99.99
STEREO MASTER	£29.99
SUPERJAM	£69.99
SUPERBASE PROF 4	£199.99
SUPERPLAN	£49.99**
SYSTEM 3	£44.99
SYSTEM 3e new version	£59.99
TAKE 2	£69.99
TECHNOSOUND	£31.99
TRANSWRITE	£28.99
TURBOPRINT PROFESS	£37.49
TV SHOW	£57.99
VIDEO EFFECTS 3D	£99.99**
VIDEOSCAPE 3D	£59.99**
VIDEO TITLER 3D	£67.49
VIDEO DIRECTOR	£104.99
WORD PERFECT 4.1	£139.99**
WORDWORTH 1.1	£79.99
3D CONSTRUCTION KIT	£37.49
3D PROFESSIONAL	£149.99

MOST EDUCATIONAL SOFTWARE ALSO STOCKED AT DISCOUNT PRICES

ASK FOR FREE
PRICE LISTS

AMIGA SUPERMARKET

We despatch 100s of orders
per week from our range of
over 500 Amiga Products.

CARTOON CLASSICS

BUILT-IN DISK DRIVE
1 MEG RAM
MOUSE
TV MODULATOR
WORKBENCH 2.
BUILT-IN CLOCK

LEMMINGS
THE SIMPSONS
CAPTAIN PLANET
DELUXE PAINT 3

LOW COST 3 & 5 YEAR EXTENDED
WARRANTIES AVAILABLE.
PLEASE SEE BELOW.

AMIGA 500PLUS

* Please phone to check
our latest low price.

ONLY £339.99*
with 2meg **£379.99***

STOP PRESS AMIGA 600 £?? PHONE FOR
AMIGA 600HD £?? PRICE

COLOUR MONITORS

PHILIPS CM8833 mk 2 UK MODEL with F19 &
On site warranty £239.99
COMMODORE 1084Sdi - new model £249.99
AOC CM326 MULTISYNC HIRES £339.99
TV TUNER - use your monitor as a tv. Costs just
£40 when purchased with 8833 or 1084 monitor;
or £50 with AOC. (£5 more if bought separately)

MONITOR ACCESSORIES

MONITOR PLINTH WITHOUT SHELF £23.99
MONITOR PLINTH WITH SHELF £33.99
DELUXE WORK CENTRE including overall dust cover,
mouse mat & holder, joystick/mouse extension set £49.99
14" MONITOR TILT/SWIVEL BASE £12.99
MONITOR DUST COVER state monitor £7.99
SCART SWITCH - effectively gives your tv or monitor two
scart sockets Enables ANY two scart leads eg Amiga & vcr, to
be connected to one scart socket. Fully switched. £19.99

AMIGA TV/ MONITOR LEADS

AL1 for most Scart tvs except some Goldstar & vcrs £12.99
AL2 for Ferguson MC01/3/5 with 7 or 8 pin din skt £12.99
AL4 for Hitachi/Granada with 7 pin RGB skt £12.99
AL6 for Amstrad CPC monitor - with no sound £11.99
AL6B for CPC monitor with stereo sound £12.99
AL7 for 1084 monitor inc audiolead (6pin Din plug) £14.99
AL7P for new 8833/1084s - 9 pin D plug £14.99
AL11 for multisync with 9 pin skt on monitor £11.99
AL11B for multisync with 9 pin plug on monitor £11.99
AL12 for multisync (our lead has 15pin HD skt) £13.99
AL13 for multisync (our lead has 15 pin HD plug) £13.99
MODULATOR EXTENSION LEAD - Moves modulator so it
does not protrude & eliminates loose connection. £10.99
MODULATOR SPLITTER - Enables modulator & RGB lead
to be connected at the same time - for taping Amiga £16.99.
GENLOCK SPLITTER £19.99
TV/ COMPUTER AERIAL SWITCH £8.99
COMPUTER / AERIAL EXTENSION LEAD 3m £2.49
Many other leads available - please phone.
All leads include audio lead where applicable & are approx
1.8m long. Add £1.50 per metre for longer leads.

HARD DRIVES - NEW MODELS AT EVEN LOWER PRICES

DATAFLYER 500S 45meg scsi £289.99*
DATAFLYER 500I 40meg IDE £259.99* NEW
DATAFLYER 500S 105meg scsi £419.99*
DATAFLYER 500I 105meg IDE £389.99* NEW
DATAFLYER 2000S 45meg scsi £259.99*
DATAFLYER 2000I 40meg IDE £229.99* NEW
DATAFLYER 2000S 105meg scsi £389.99*
DATAFLYER 2000I 105meg IDE £359.99* NEW
Available soon - IDE version with 8meg on board ram
option, & external power supply.

FIT YOUR OWN DRIVE: IDE (AT) OR SCSI
DATAFLYER 500S HOUSING & SCSI INTERFACE £129.99
DATAFLYER 500I HOUSING & IDE INTERFACE £119.99 NEW
DATAFLYER 2000S SCSI INTERFACE £89.99
DATAFLYER 2000I IDE INTERFACE £84.99 NEW

* DRIVE SIZES QUOTED ARE APPROXIMATE FORMATTED SIZES
& MAY VARY SLIGHTLY DEPENDING UPON MAKE OF DRIVE
FITTED. New IDE versions work with most IDE drives.

GVP HARD DRIVES

GVP SERIES II HD8+ 52 Quantum for A500 £359.99
GVP SERIES II HD8+ 105 Quantum for A500 £469.99
GVP SERIES II HC8 no drive/ for 1500/2000 £139.99
GVP HD8+ PC286 EMULATOR MODULE £239.99

PRINTERS

CITIZEN 120D+ now down in price £129.99
CITIZEN 124D - best budget 24 pin b/w £194.99
CITIZEN 224D (24pin - colour option) £224.99
CITIZEN SWIFT 9 (colour option) £177.99
CITIZEN SWIFT 9X B/W wide carriage £257.99
CITIZEN SWIFT 24E (colour option) £269.99
CITIZEN SWIFT 24X wide carriage £379.99
CITIZEN PRODOT 9 - PROF QUALITY £199.99
FOR COLOUR KIT to convert 224D, SWIFT 9, PRODOT 9 &
SWIFT 24, to colour, add just £20.00. Add £30 for colour kit for
9X & 24x. (Colour kit contains ribbon & ribbon motor unit)
CITIZEN PROJET INKJET PRINTER £399.99**
CANON BUBBLEJET BJ10EX £269.99

STAR PRINTERS

STAR LC20 b/w now down in price £144.99
STAR LC200 colour £209.99
STAR LC24-200 b/w £239.99
STAR LC24-200 colour £299.99
FREE PRINTER CABLE & DRIVER DISK WITH ALL PRINTERS

PRINTER ACCESSORIES

UNIVERSAL PRINTER STAND - open frame type with
paper holder for all 80 column printers. £12.99
TWO PIECE PRINTER STAND for any printer £7.99
80 COLUMN PRINTER DUST COVER state printer £7.99
COPY HOLD - FREE STANDING OR CLAMP £16.99
60grm Fan fold 11x9.5" paper in box of 2000 sheets £21.99
A4 60grm white paper in packs of 500 sheets £5.99
AMIGA PRINTER PORT EXTENDER - 2WAY £24.99
AMIGA PRINTER PORT EXTENDER - 3WAY £27.99
AMIGA PRINTER PORT EXTENDER - 4WAY £33.99
Above Printer port switch prices include cable worth £10.99 to
connect switch to Amiga. These switches are fitted with
sockets identical to the Amiga's printer port - so your printer
cables & other peripherals just plug straight in.
PRINTER SHARER - 2WAY inc free lead £27.99
PRINTER SHARER - 3WAY inc free lead £29.99
PRINTER SHARER - 4WAY inc free lead £34.99
These have sockets as fitted to printers (36w centronics) &
enable one printer to be used with several computers. Lead to
connect switch to printer included.

AMIGA PRINTER LEADS

AMP1 1.8m long for all parallel printers £9.99
AMP 2 3m long for all parallel printers £12.99
AMP 3 5m long for all parallel printers £16.99
PRINTER PORT EXTENSION LEAD (M-F) £10.99
PRINTER PORT TO SWITCH LEAD (M-M) £10.99
PRINTER RIBBONS (Compatible types)
9 PIN B/W 80 column ribbon - state printer - available for
popular Amstrad, Citizen, Panasonic, & Star £4.99
24 PIN B/W 132col ribbon for LC15, Swift9x/24x £6.99
Swift 9 & 24 Colour ribbon (Citizen brand) £15.99
Star LC200 & LC24-200 Colour ribbon (Star brand) £15.99
RIBBON RE-INKING SPRAY - BLACK ONLY £13.99

Use a redundant XT drive on an Amiga500.

The Cumana ST506 xt Drive interface with 1/2meg ram & on board
clock, fits into the 1/2 meg slot, & enables most ST506/ST412 drives to
be used. (Drive power supply & housing not included) £79.99

COMMODORE A590+

A590 + (no ram) 20meg Hard drive £279.99*
A590 inc 1meg ram £309.99
A590+ inc 2meg ram £339.99
A590 45meg SCSI upgrade - easy to fit £199.99
A590 105meg SCSI upgrade - easy to fit £329.99

AMIGA PLUS 1.3 COMPATIBILITY.

We can install a rom sharer,
with 1.3 workbench rom, &
if you need more faast ram,
our Baseboard Plus
memory upgrade. There is
no fitting charge if done
prior to purchase, however,
the Commodore warranty
will be invalidated, so we
recommend an Extended
warranty be taken out.

SUPERB 10 STAR PACK just £39.99 extra with any Amiga

MICROSWITCH JOYSTICK
10 DISKS, LABELS & BOX
MOUSE MAT
TAILORED DUST COVER
PLUS 10 GREAT GAMES:
DUNGEON QUEST
SOCCER
KID GLOVES
RVF HONDA
POWER PLAY
SHUFFLE PUCK CAFE
TOWER OF BABEL
DATASTORM
EMOTION
GRAND MONSTER SLAM

AMIGA 500 1.3 Base Model

Amiga 500, 512k ram, workbench 1.3, psu,
mouse, tv modulator & instruction manuals.
No extra software. Add £20 for extra 1/2 meg
(without clock) **ONLY £289.99****

SPECIAL BONUS PACK.

AMIGA 500 1.3 as above
+ PHOTON PAINT 2 + GFA BASIC+ TEN STAR GAMES
PACK (games only - excludes accessories) £299.99
HURRY - Limited stocks.

AMIGA 1500 Wkbench 2 £559.99

With 1meg ram, twin disk drives. + Software pack comprising:
Dpaint 3, Home Accounts, The Works, Elt, Toki, Puzznic &
'Get the Most from Your Amiga'.
Deduct £60 if software pack not required.

EXTERNAL DRIVES.

ROCLITE RF382C £58.99
ROCTEC 5 1/4" DRIVE £79.99
CUMANA CAX 354 £58.99
All are Amiga PLUS, 600 & CDTV compatible.
All drives feature thru port & disable switch.

MEMORY UPGRADES

A500 1/2meg without clock £23.99
A500 1/2meg upgrade with clock £27.99
LOW POWER, 4 CHIP DESIGN, WITH ON/OFF SWITCH.
Just plug in, warranty unaffected, Amiga Plus compatible.
NEED EVEN MORE MEMORY? Then fit a...
BASEBOARD 0.5 TO 4 MEG UPGRADE for Amiga 500
BASEBOARD UNPOPULATED £79.99
BASEBOARD WITH 1MEG special price £99.99
BASEBOARD WITH 2 MEGS £139.99
BASEBOARD WITH 4 MEGS £219.99
ZYDEC 1.5MEG UPGRADE £79.99
Internal fitting, invalidates warranty.

AMIGA 500 PLUS 1 meg upgrade £44.99
Just plugs in. No soldering. Warranty unaffected. Gives you 2
megs in total. (Made by Phoenix)

NOT ENOUGH FAST RAM? You need a...

BASEBOARD PLUS 1 - 4 MEG UPGRADE.
BASEBOARD PLUS - 1MEG £99.99
BASEBOARD PLUS - 2MEG £139.99
BASEBOARD PLUS - 4 MEG £219.99
Internal fitting - invalidates warranty - but can be covered by
our Extended warranty plan, taken out at time of fitting.

AMIGA 1500 & 2000 UPGRADES.

2-8 MEG RAM CARD (unpopulated) £79.99
1meg x9 80ns simms £37.99 each

Our Extended Warranty & Insurance plan could save you ££s on accident & repair bills.

When you buy any computer, printer or monitor from us,
we can offer you a low cost Extended Warranty with
Accidental Damage Insurance. Underwritten by a
leading UK insurance company. For example your Amiga
500 can be covered for three years from date of
purchase for only £44.99, or £64.99 for five years from
date of purchase. Covers all repairs & accidental
damage, with very few exclusions. Must be taken out
within 30 days of purchase. **Atypical Amiga repair costs
at least \$45 - & that's at today's prices - so you can't go
wrong!**

OAP & STUDENT DISCOUNT SCHEME

If you are an OAP or Bona fide full time higher education
student (uni, college or poly), we will give you at least 2 1/2%
discount off most items. Bring your Pension book, Student's
Union card or Student Poll tax card if calling, or send a signed
photocopy, & payment by Cheque, cash or PO only (not
credit card). Please confirm price & availability first.

SALES HOT LINES: 0274 - 691115. Lines open from 8am

© TRILOGIC 1992. E&OE Prices charged are those current on the day you order - occasionally, some may have change either
way since this advertisement was completed (10/4/92) All information herein & opposite, is given in good faith, but no
responsibility or liability is accepted for any errors, omissions or inaccuracies. Please phone if in doubt or before calling to
check availability. ORDERS FROM PLCs, LOCAL GOVERNMENT & EDUCATIONAL ESTABLISHMENTS WELCOME.

Q Just what is a startup-sequence?

A A lot of people seem to think that, by just putting a standard bootblock onto a disk (using the Install command) that the disk will automatically start working and running programs. They are then puzzled when the disks don't work.

Using a standard bootblock, the computer sets itself up using any preference settings (these are stored in a file called system-configuration, found in the devs directory). They then look for a file called startup-sequence, in the s directory. If one isn't found then they stop dead. Otherwise it's executed as a script file.

Unless you're a computer buff already, that won't make a lot of sense. I'll assume, for a moment, that you've managed to type a few commands into the Shell and got them to work. A script file is a document file stored on disk, similar in some ways to a word processor document like an invoice or letter. However, script files are lists of AmigaDOS shell commands.

By typing this into the Shell, where nameofmyscript is the name and path of a script file:

```
Execute nameofmyscript
```

The script file is executed, just as though you sat down at the Shell and typed all the commands in one at a time. Startup-sequences are script files which set the Amiga up, to give a stable environment to run programs from. A startup-sequence can be as simple as:-

```
Nameofaprogram
```

If Nameofaprogram is the file name of a program on the disk, then the Amiga will start up, read in the startup sequence, and then run the program directly. Here's a slightly more ambitious startup-sequence, as used on certain **Amiga Format** Coverdisks:-

```
Binddrivers
Setpatch >Nil:
Loadwb
Endcli
```

The Binddrivers command is used to set up all driver programs available on the disk, to make things like the serial port and printers work. The Setpatch command varies with each release of Kickstart, but its purpose is to correct any bugs within a given Kickstart ROM chip. Loadwb sets up a Workbench screen, and Endcli causes the startup-sequence to finish and control is passed to Workbench.

Answerfile

Right, on to our quick-fire Q-and-A round, hosted by our man with intimate knowledge of the Amiga, **Pat McDonald**, so take your seats and let's have our first quickie...

Q Why don't you mention the C language more often? You do seem to be biased heavily towards AMOS and machine code.

A It is true that I am biased to AMOS and machine code as beginners' languages. This may seem strange, especially considering that machine code is a very tricky and time-consuming language to use. However, when you appreciate the complexity of the Amiga's disk operating system, and the facts that a) AMOS turns it off and b) while using machine code you usually turn it off, you can understand why.

With AMOS, you can start getting results very quickly. With machine code, because of its simplicity, you can program without the operating system 'getting in the way' to get simple, fast results. However, C certainly has a very important role...

C is often the language of choice in higher educational establishments. If you're studying programming at a university, then C will almost certainly be mentioned quite extensively. But there's a world of difference between being taught programming at that level, and learning it in your own home.

If you want to write programs that make use of the Amiga's multitasking operating system, using the built-in libraries and functions, then by and large C will serve you very well. There is a fairly large amount of literature on the subject - the PD Amiga C Manual by Anders Bjerin and Understanding Amiga C by Paul Overaa are just two examples.

The trouble is that practically all such documentation assumes that you know how computers work, you know how AmigaDOS works, and you know the theory of program design and debugging. A great language, that's often used to port down massive graphics processing projects from mainframe machines, C just isn't a beginners language in my opinion.

Q I have recently got Workbench 2 - I have a 1Mb machine - and I can't get the RAD: (recoverable RAM drive) to work. How do I do it?

A Thanks to John Russell of Gravesend for the solution, who wins a £50 Mail Order voucher for his trouble. Apparently there is a mistake in the mountlist file, which is stored in the devs directory. First, load Workbench, and double click on the Shell icon. After that, type:

```
Ed devs/mountlist
```

After a few moments of disk access, the mountlist file will appear, ready for editing. Move the cursor down - the cursor responds to the keys with arrows on, remember - through the various entries until you come to the one marked RAD:. The HighCyl value should be at least 21 (same as for Workbench 1.3) otherwise it doesn't have enough space to work. Changing it to a higher value will grab more memory away from the system, but allows you to store more in the RAD:.

If you're totally lost inside Ed and want to quit without changing anything, press the Esc key, then the Q key and then Return, to quit back to the Shell. Only when you are happy with the changes should you save the file (by pressing Esc, then X, then Return).

Q Are there any PD programs that you would recommend for designing icons? If any programs could load pictures from Deluxe Paint and save them as icons, it would be even better.

A The program you want is called *Icon Master*. It originally appeared on *ST/Amiga Format* Coverdisk 13, but it has since become widespread through the Public Domain.

Q I have noticed that a lot of your Coverdisk programs don't work on my unexpanded A1500. Why is this, and is there anything I can do?

A I am assuming that you are using a 1.3 A1500 or A2000 with no extra memory. The built in memory of these machines is always chip RAM (1Mb of chip RAM, no fast RAM). Buying a memory expansion will help but there is another point, and one that few people understand about Workbench 1.3.

Kickstart 1.3 was programmed to access only 512K of chip RAM, and frequently fails with larger amounts, especially when no fast RAM is available. The secret is in the Setpatch command. Boot up Workbench, double click on the Shell, and type (XX is the Coverdisk's number - for instance, SpectracolorJr is on Coverdisk35a):-

```
Ed CoverdiskXX:s/startup-sequence
```

After that, move the cursor down to the Setpatch command, and alter it so that it reads:-

```
Setpatch >Nil: r
```

That final 'r' is the important part - it tells the Setpatch command to set the Amiga up to expect 1Mb

Q Are you absolutely sure that the SupraRAM 2000 memory expansion takes 256 x 4 chips, as stated in **Amiga Format** Issue 33?

£50

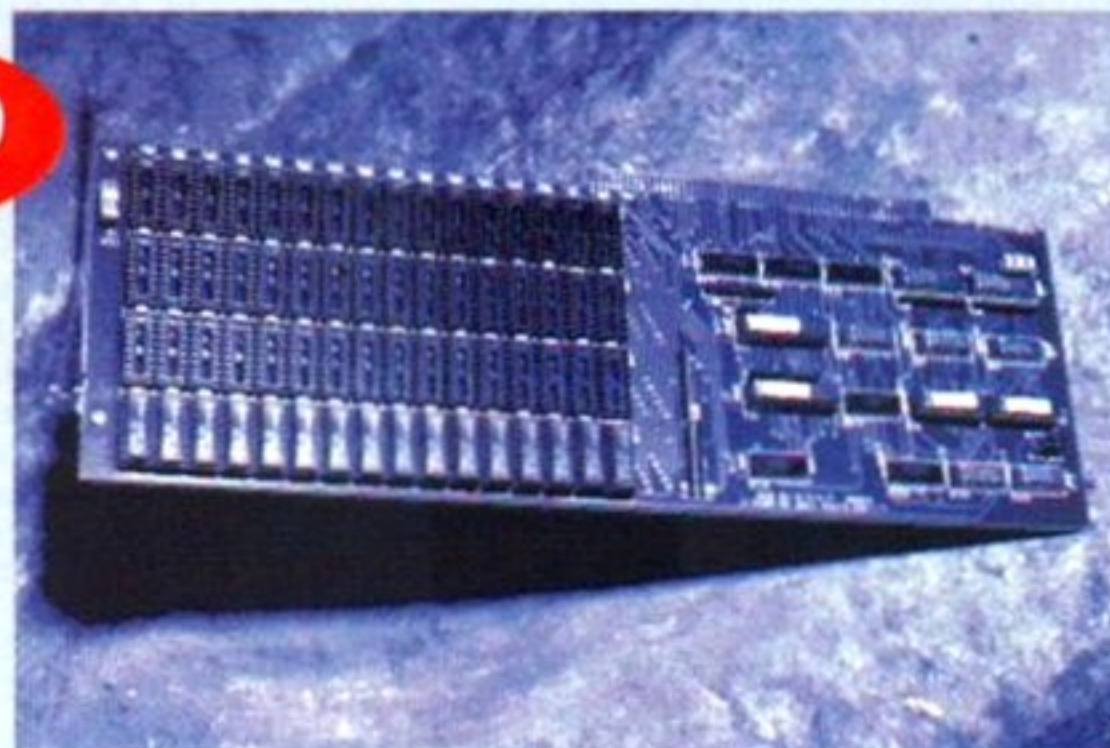

A I have to admit that I was mistaken in this. The SupraRAM 2000 does take 1Mb X 1 type chips, and so requires 16 such chips for each 2Mb of extra memory - the speed of the chips must be 120ns (nano-seconds) or faster. My thanks to AE Shaw of Cambridge for pointing out my error - a prize is on the way.

If the SupraRAM 2000 did take 256 x 4 sized chips, then it would need 256 of them. It clearly hasn't got that many sockets.

of chip RAM. To save the file, press Esc, then X, then Return. To abort without saving (if you've made a mistake) press Esc, then Q, then Return. Always remember to do this to copies of the Coverdisk.

Why don't I do this on the Coverdisk? Perhaps when everybody has 1Mb of chip RAM I will.

Q Is it really worth buying a second disk drive?



The range of second floppy drives for the Amiga is large and growing – and at least one is a must for serious work, unless you like swapping disks that is.

A Yes. If you want to use the Amiga seriously, and especially if you want to program or use the Shell properly, a second disk drive – whether hard or floppy – makes a huge difference, simply because you are not swapping between disks all the time.

Q I have read your sister magazine with great interest on the subject of the next generation of the Amiga computer family. I am especially interested in the proposed A800 machine, which apparently has 16-bit sampling quality and a 68020 processor as standard. Does it really exist? When will it and any other machines be available?

The A800 and A4000 almost certainly do exist, at least in prototype form, but to understand what that means you have to appreciate Commodore's research and development style. What they do is sit down and come up with a paper design - if this has no obvious flaws then a few prototypes are hand-built for evaluation.

After that, a design can wait for months, even years, on a shelf. Commodore Amiga are in the habit of taking such old designs as needed, tweaking them for the latest in Amiga spec (Workbench 2, 1Mb of chip RAM and so on) only when their hefty market research pinpoints the need for such a machine.

For instance, one of the main criticisms of the Amiga was the relative expense of adding a hard disk drive: much more expensive than on a PC system. Hence Commodore release a machine with a very cheap hard disk option (the A600, at £499 for the hard drive version, is the cheapest way to get the convenience of a hard disk on an Amiga).

So the machine certainly exists, if only in mockup form. My own opinion is that it, or a machine with a similar specification, will appear very soon. This is based on two factors: Commodore have "no plans at all" for upgrading the A1500/A2000 to use 2Mb of chip RAM, according to Andrew Ball, marketing manager of Commodore UK. That means that no machine in between the A500 Plus and the A3000 can 'officially' have 2Mb of chip RAM. The other is a less formal statement, made by last year, that summer 1992 would see a shakeup of the Amiga range. Now that the A600 'sawn-off' is here, a more upmarket, up-to-date machine is surely just a matter of time.

Indepth explanation Number 3: File Types



Art Department Professional (pictured left) is one of the most powerful pieces of file translation software available for the Amiga. It can deal easily with 24-bit images, giving you a cut down 'preview' at the best resolution that a standard Amiga can handle. It's truly easy to use, but it's not on the cheap side – to deal with some slightly obscure file types like Mac PICT or TARGA you need an expansion pack for it.

A lot of people seem to think that files, directories and programs are all the same thing. If you keep getting the message "Not an IFF file" on *Deluxe Paint*, "Not a Vista DEM Landscape" with Vista or scrambled text files using a word processor, some explanatory notes could well make matters clearer.

1 If you've ever been in Shell and used the Dir or List commands, an inventory of the disk, showing all files, directories and their lengths will result. However, neither of these commands show the type of a file – which can be very confusing at times.

2 There are two main groups of file. The first is the program file, which is sometimes called a tool on the Amiga. Simply clicking on the icon or typing the name into the Shell will cause the program to start working. The other type is the data file, which is not a program and cannot be run, but must be manipulated from within a program. Data files are sometimes called projects on the Amiga, and unlike program files, there are many kinds of data file.

3 The most common kind of data file is the ASCII (American Standard Code for Information Interchange) text file. ASCII can store letters (both upper and lower case), numbers, and most punctuation marks. However, it has no facility for storing non-American characters such as the pound sterling (£) symbol. ASCII serves as the basis for most word processor file types, with variations for effects like text size, italics, underlining and so on.

4 In addition to word processors, there are many database programs and some spreadsheets that can load ASCII files, for transferring data between different programs and even different computer systems. Typically, such data has to be tweaked slightly to get it to work – but that's usually a lot quicker than typing the whole lot in again.

5 The second most common data file type is the IFF, which is short for Interchange File Format. This is used for storing picture information (for transferring pictures from Vista to *Deluxe Paint*, for instance) and also sound sample information. IFF files are very much specific to the Amiga computer, although the basic system

(ILBM, InterLeaved Bit Map) occurs sometimes in the IBM PC world.

6 The Vista DEM format is something of a one-off. It is used only by Vista and its variants, and is used to store landscapes for later use by such programs.

7 Two other common types of data file are the ANIM and the animbrush (usually abbreviated to ABR). These are both supported in *Deluxe Paint*, and are used for storing complete animations (ANIM) and a brush with many different frames (ABR). If you look closely at the *Deluxe Paint* menus, you'll see load-and-save options under the relevant menu.

8 One other very common file with limited usage is the RAW format, which is short for raw binary. These files are multipurpose, and are usually the preserve of the programmer and hacker. However, one usage for them is for sound samples: although IFF sound samples are easier to play at different tones, they do not have the same quality as a RAW sound sample. Hence most *Tracker* and *Sequencer* programs have the facility for playing RAW sound samples as well as IFF ones.

9 Whenever you save a file, it makes sense to add the filetype to the end of the filename. Picture.IFF, for instance. Some programs – AMOS for example – do this anyway, but with most (and especially *Deluxe Paint*) life is a lot easier if you know when a file is a picture, an animation, a text file or a sound sample.

10 A common misconception is that programs on an Amiga disk are simply RAW binary files of machine code. This is not true! Before a RAW program can be used under AmigaDOS, it must first be run through a special program called a linker. Two versions, the very old ALink and the slightly newer but much more common BLink are used for the task.

AMEAGRE PRICES FOR AMIGA USERS

GAME	PRICE	GAME	PRICE	GAME	PRICE
2 Hot 2 Handle (Comp)	20.95	God Father - Action Game	20.95	Pools of Darkness	21.95
10 Great Games	20.95	Gods	17.45	Populous 2 (1Mb)	20.95
3D ConstructionKit	33.95	Graeme Souness's Soccer	17.45	Populous World Editor	11.95
4 Wheel Drive (Comp)	20.95	Grandstand (Comp)	20.95	Power Pack (Comp) (NOT+)	17.45
4D Sports Boxing	17.45	Hagar The Horrible	17.45	Power Up (Comp)	20.95
4D Sports Driving	20.95	Hard Nova	17.45	Powermonger	20.95
50 Great Games (only 30 on +)	17.45	Harlequin	17.45	Powermonger Data Disk (WW1)	11.95
A320 Airbus	25.99	Head Over Heels	6.96	Prince Of Persia	17.45
AMOS 3D	23.95	Heart Of China (1Mb)	23.95	Pro Tennis Tour 2	17.45
AMOS Compiler	20.95	Heimdall (1Mb)	23.95	Proflight	29.45
AMOS The Creator	33.95	Henrietta's Book Of Spells	17.45	Project X (1Mb)	17.45
Action Master (Comp)	20.95	Heroes Of The Lance	6.96	Quest & Glory (Comp)	20.95
Action Pack (Comp)	19.95	Heroquest	17.45	Quest For Adventure (Comp)	23.95
Advanced Fruit Machine	5.95	Heroquest - Data Disk	11.95	Quest For Glory	26.96
Agony	17.45	Heroquest - Twin Pack	20.95	R-Type II (NOT+)	17.45
Air Sea Supremacy (Comp)	20.95	Hill Street Blues	17.45	R.B.I. Baseball 2 (NOT+)	20.95
Air-Land-Sea (Comp) (688 NOT+)	23.95	Hitchhikers Guide to the Galaxy	7.95	Race Drivin'	20.95
Alien Breed (1Mb)	17.45	Hollywood Collection (Comp) (NOT+)	20.95	Railroad Tycoon (1Mb)	23.95
Alien Storm	17.45	Home Accounts 2	39.95	Rainbow Collection (NOT+)	13.95
Amnios	17.45	Home Alone (NOT+)	17.45	Realms	20.95
Another World	17.45	Hudson Hawk	17.45	Rick Dangerous II	17.45
Aquadventura	23.95	Hunt For Red October	17.45	Rise Of The Dragon	26.95
Arkanoid II - Revenge of Doh	6.96	Hunter	20.95	Risk	13.95
Armour-Geddon	17.45	IK+	6.96	Robin Hood	17.45
Atomino	17.45	Impossamole	6.96	Robocod	17.45
Award Winners (Comp)	17.45	Indiana J & L. Crusade (Act)	6.96	Robocop III	17.45
Baby Jo	17.45	Indianapolis 500	17.45	Rod-Land	17.45
Barbarian II (Psygnosis)	17.45	Iron Lord	7.95	Rolling Ronny	17.45
Batman - Caped Crusader	6.96	Ivanhoe	6.96	Rotox	7.95
Batman - The Movie	6.96	Jack Nicklaus Unl. Golf (1Mb)	20.95	Rugby - The World Cup	17.45
Battle Chess	17.45	James Bond Collection	17.45	Scooby-Doo & Scrabby-Doo	6.96
Battle Chess II (NOT+)	17.45	James Pond	6.96	Secret Of Monkey Island (1Mb NOT+)	17.45
Battle Isle	20.95	Jimmy White's Snooker	20.95	Secret Of The Silver Blades	20.95
Beastbusters	17.45	Jupiter's Masterdrive	6.96	Shadow Of The Beast	17.95
Better Maths (12-16)	17.95	Kick Off II (1Mb)	17.45	Shadow Of The Beast II	17.45
Better Spelling (8-Adult)	17.95	Kid Gloves II	17.45	Shadowlands	20.95
Big Run	17.45	Kind Words 2	36.95	Shadow Sorcerer (NOT+)	19.95
Birds Of Prey (1Mb)	23.95	Kings Quest V (1Mb)	26.95	Shoe People	17.45
Black Crypt	17.45	Knightmare	20.95	Shinobi	7.95
Blues Brothers (NOT+)	17.45	Knights Of The Sky (1Mb)	23.95	Shufflepuck Cafe	6.96
Board Genius (Comp)	20.95	Last Ninja III	17.45	Silent Servie II (1Mb)	23.95
Bonanza Brothers	17.45	Leander	17.45	Silkworm	7.95
Boston Bomb Club	17.45	Leather Goddess Of Phobos	7.95	Sim City/Populous	20.95
Brides of Dracula	17.45	Leisure Suit Larry V (1Mb) DF	23.95	Sim Earth	20.95
Bubble Bobble (NOT+)	6.96	Lemmings	17.45	Simpsons	17.45
Capcom Collection	20.95	Lemmings Levels (Data Disk)	13.95	Sir Fred	6.96
Cardinal Of The Kremlin	17.45	Lemmings Levels (Stand Alone)	17.45	Smash TV	17.45
Casino	17.45	Life And Death	17.45	Soccer Manager - Multi Player	17.45
Castles	20.95	Little Puff (NOT+)	6.96	Soccer Stars (Comp)	17.45
Celtic Legends	20.95	Lombard RAC Rally	6.96	Space 1889	20.95
Challengers (Comp)	20.95	Lord Of The Rings	17.45	Space Ace II	23.95
Chart Attack - Vol 1 (Comp)	20.95	Lotus Turbo Challenge II	17.45	Space Crusade	17.45
Chase HQ	6.96	M1 Tank Platoon	20.95	Space Quest 4 (1Mb)	23.95
Chase HQ II	17.45	MAX (Comp) (NOT+)	20.95	Special Forces	23.95
Chips Challenge	17.45	Maddog Williams	20.95	Spirit Of Excalibur	20.95
Cruise For A Corpse	19.95	Magic Maths (4-8)	19.95	Spot	13.95
Cyberoon III	17.45	Magic Pockets	17.45	Star Collection	17.45
D.T. Olympic Challenge	6.96	Magic Storybook (1Mb)	20.95	Steve Davis Snooker	6.96
Darkman	17.45	Magnetic Scrolls Collection	20.95	Storm Master	20.95
Death Knights Of Krynn (1Mb)	20.95	Manchester United Europe	17.45	Stratego	17.45
Defenders Of The Earth	6.96	Maths Mania (8-12)	17.95	Super Sega (Comp)	20.95
Deluxe Paint IV	59.95	Mavis Beacon Teaches Typing (NOT+)	20.95	Super Sim Pack (Comp)	19.95
Deuteros (NOT+)	20.95	Mega-Lo-Mania/First Samurai	20.95	Super Space Invaders (NOT+)	17.45
Dizzy Collection	17.45	Mega Maths	17.95	Supercars II	17.45
Dizzy's Excellent Adventures	17.45	Mega Twins (NOT+)	17.45	Superheroes (Comp)	20.95
Double Dragon	7.95	Megatraveller I (1Mb)	20.95	Supremacy	20.95
Double Dragon II	7.95	Mercenary 3	20.95	Suspicious Cargo	17.45
Double Dragon III	17.45	Mercs	17.45	Switchblade II	17.45
Elf	17.45	Micro English	18.95	Terminator II	17.45
Elvira I (1Mb) (NOT+)	20.95	Microprose Golf (1Mb)	23.95	Test Drive II Collection	20.95
Elvira II	23.95	Midnight Resistance	6.96	Thunderhawk	20.95
Exile	17.45	Midwinter II (1Mb)	23.95	Thunderjaws	17.45
Exodus 3010	20.95	Mig 29M Super Fulcrum (NOT+)	26.95	Tin Tin On The Moon	6.96
Eye Of The Beholder (1Mb)	20.95	Moonbase (1Mb)	23.95	Tip Off	17.45
Eye Of The Beholder II (1Mb)	23.95	Moonstone	20.95	Titus The Fox	17.45
F-15 Strike Eagle II (1Mb) (NOT+)	23.95	Moonwalker (NOT+)	6.96	Toki (NOT+)	17.45
F-16 Combat Pilot	7.95	Movie Premier Collection	20.95	Top Banana	17.45
F-19 Stealth Fighter	20.95	Mystical	7.95	Top League (Comp)	20.95
F-29 Retaliator (NOT+)	17.45	Myth	17.45	Treasure Island Dizzy	4.49
Face Off - Ice Hockey (NOT+)	17.45	Nebulus 2	17.45	Turbo Charge	17.45
Fantastic Voyage	17.45	Neighbours	17.45	Turrican II	6.96
Fantasy World Dizzy (NOT+)	6.96	New Zealand Story	6.96	Turtles 2 - Coin-Op	17.45
Fast Food (NOT+)	5.95	Ninja Collection	13.95	U.M.S. II	20.95
Final Blow	17.45	Ninja Remix	17.45	Ultima V (NOT+)	20.95
Final Fight (NOT+)	17.45	Ninja Warriors	7.95	Ultima VI (1Mb) DF	20.95
Fists Of Fury (NOT+)	17.45	Nitro	6.96	Utopia	20.95
Flood (NOT+)	8.95	North & South	6.96	Video Kid	17.45
Football Crazy (Comp)	17.45	Operation Wolf (NOT+)	6.96	Virtual Reality 1 (Comp)	23.95
Football Director 2 (NOT+)	17.45	Ork	17.45	Virtual Worlds (Comp)	20.95
Formula One Grand Prix	23.95	Outrun Europa (NOT+)	17.45	Viz	73.95
Full Contact (NOT+)	7.95	PGA Extra Courses	11.95	Wacky Races	6.96
Fun School 4 (5-7)	17.45	PGA Tour Golf	17.45	Warzone	13.95
Fun School 4 (Over 7s)	17.45	PGA Tour Golf +	20.95	Willy Beamish	23.95
Fun School 4 (Under 5s)	17.45	Pacific Islands	20.95	Wolfchild	17.45
Fuzzball	13.95	Paperboy 2	17.45	Wonderland (1Mb)	20.95
G-Loc	17.45	Parasol Stars	17.45	Wordworth V1.1	83.95
Gateway To The Savage Frontier	21.95	Pegasus	17.45	World Class Leaderboard	6.96
Gauntlet II	6.96	Pball Dreams	17.45	World Class Rugby	17.45
Gauntlet III	17.45	Pirates (NOT+)	17.45	World Class Rugby - 5 Nations	20.95
GB Route Plus (1Mb)	55.95	Pit Fighter	17.45	Wrestlemania - WWF	17.45
German Master	13.95	Platinum (Comp)	17.45	X-Out	6.96
		Police Quest 3 (1Mb)	23.95	Z-Out	6.96

3 1/2"

Double Sided
Double Density

QUANTITY	PRICE
10	£4.75
20	£9.25
25	£11.30
30	£13.25
35	£15.10
40	£16.90
45	£18.80
50	£20.50
80	£32.45
100	£36.90
120	£43.70
150	£53.85
200	£68.95
300	£103.45
400	£135.95
500	£167.50

WITH LABELS & WARRANTY

BOXES

(with keys and dividers)

10 Slimpack	0.94
40 capacity	£4.95
50 capacity	£5.60
80 capacity	£6.30
100 capacity	£6.80
120 capacity	£8.75
150 Deluxe stackable	£21.95

JOYSTICKS

Python 1 (QS130F)	£9.25
Maverick 1 (QS128F)	£13.75
125+	£9.00
The Bug	£13.50
Star Probe	£13.50
Competition Pro 5000 - black	£13.75
Speeding A/F	£11.00
Navigator A/F	£13.75
Topstar (SV127)	£21.50
Supercharger (SV123)	£9.00
Sting-Ray A/F	£12.50
Megastar A/F (SV133)	£22.00

MISCELLANEOUS

Cartoon Classics Pack	£359.95
Philips CM8833II monitor	£246.75
Deluxe Work Centre	£46.95
Cumana Disk Drive	£57.95
.5Mb Upgrade + clock	£29.95
.5Mb Upgrade	£26.95
1Mb Upgrade (500+)	£56.95
Mouse	£14.75
Mouse Mat	£2.95

SPECIAL OFFER
Cartoon Classics + monitor
£589.25

All Prices include UK postage and VAT and are effective until 8th June 1992

Overseas orders - Postage charged at cost.

New titles will be sent as they are released and are subject to manufacturers price reviews.

Credit Card orders:
(10.00am - 10.00pm, 7 days not an answer phone)

071-608-0624

Cheques/Postal Orders to
DataGem Ltd, Dept AF, 23 Pitfield Street, London N1 6HB
Showroom open Monday - Friday 10am - 6pm Exit 2, Old Street Tube
All orders taken subject to our standard terms & conditions

EXPAND YOUR AMIGA

QUALITY PRODUCTS
at affordable prices
W.T.S. ELECTRONICS LTD.



STOP PRESS!
Kickstart 2.04 kit
complete including
full manuals only **£99!!**
IN STOCK NOW



British Made

A500 PRO-RAM BOARD 1/2 MEG UPGRADE

- Latest design incorporates chipmem option at no extra cost
- Increases computer memory from 1/2 Megabyte to 1 Megabyte
- Allows all 1 Megabyte software to run. Now Commodore A500 standard
- Direct replacement for Commodore A501, 16 Chip Technology for complete compatibility.

£25.00 without clock

£28.00 with clock

UPGRADE TO AMIGA 500 PLUS

☆ Upgrade the standard Amiga 500 to ECS chipset A500 plus capability ☆

- ★ **KICKSTART 2.04** **£49** • Upgrades your existing Kickstart to that of the new A500 plus
- ★ **HIGH-RES DENISE** **£39** • Upgrades your graphic chip capability to that of the A500 Plus inc. anti-flicker
- ★ **8372 FATTER AGNUS** **£49** • Enables you to access 1Mb of chip memory with standard modification
- ★ **8375 2MB FATTER AGNUS** **£65** • Enables you to access a full 2Mb of chip memory when fitted in adaptor board
- ★ **2.04/1.3 KICKSTART SWITCHBOARD** **£24** • Overcomes software compatibility problems at the flick of a switch
- ★ **KICKSTART 1.3** **£36** • Allows existing A500 Plus owners to run old software when used in conjunction with switchboard
- ★ **A500 PLUS 1MB UPGRADE** **£39** • Upgrades A500 Plus memory to 2Mb chip memory.

- ★ **GVP 52MB A500 HARD DRIVE** **£369!**
- ★ **GVP 52MB A500 HARD DRIVE + 2MB** **£424**

500AX 2Mb - 8Mb MEMORY EXPANSION

- 500AX 2Mb**£179.00**
- 500AX 4Mb**£244.00**
- 500AX 8Mb**£380.00**

SUPRA MODEMS



- 100% Hayes compatible
- Tone Pulse auto dial/answer
- RS232 Interface
- Internal diagnostics
- Programmable number storage

Supra 2400**£119.00**
Supra 2400+**£174.00**

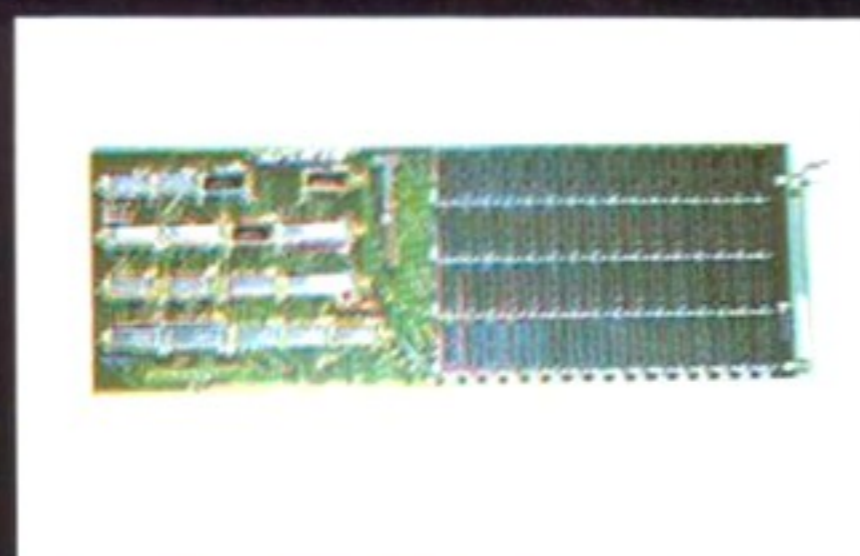

A2000 MEMORY UPGRADES

- 0Mb ...**£109.00**
- 2Mb ...**£149.00**
- 4Mb ...**£189.00**
- 8Mb ...**£269.00**

CUMANA 3.5" EXTERNAL DISK DRIVE



- High quality
- High specification
- Anti click
- Long moulded cable

£54.00

- A500 Internal replacement drive.....**£44.00**
- Kickstart 2.04 kit includes full manuals + disks**£99.00**
- GVP 52Mb Hard Drive A2000**£279.00**

A500 HIGH CURRENT POWER SUPPLY

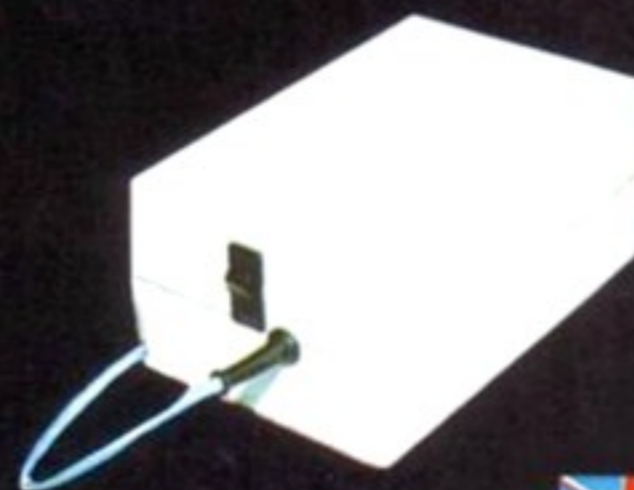

- Allow addition of many peripherals without damage to computer or power supply
- Switch mode design

£44.95



British Made

☆ All prices include P&P & VAT ☆ Please add £5.00 if you require 24 hour courier to your door or parcel post will be used ☆ 12 month warranty ☆

W.T.S. ELECTRONICS LTD, Chaul End Lane, Luton, Beds.

Tel: 0582 491949

SPECIAL OFFERS

TITLE	PRICE	TITLE	PRICE
Atomic Robokid	5.99	Jockey Wilsons Darts	2.99
Back to the Future II	6.99	Kick Off and Extra Time	5.99
Back to the Future III	6.99	Kick Off II (1 Meg)	9.99
Batman The Movie	5.99	Killing Cloud	7.99
Big Box Compilation	15.99	Magnetic Scrolls	9.99
Bubble Bobble	5.99	Manix	5.99
Captain Fizz	5.99	Mind Bender	5.99
Captive	9.99	New Zealand Story	5.99
Carve Up	6.99	Pacland	4.99
Combo Racer	5.99	Pacmania	4.99
Computer Hits II	9.99	RAC Rally	5.99
Corporation	5.99	Resolution 101	5.99
Cricket 1 Meg	9.99	Rick Dangerous	5.99
D. Double Horse Racing	5.99	Spirit of Excalibur	9.99
Days of Thunder	5.99	Stack Up	2.99
Dragon Spirit	4.99	Stun Runner	2.99
Escape Planet Robot		Steve Davis	5.99
Monsters	4.99	Thunderstrike	5.99
Ghouls & Ghosts	5.99	Toobin	4.99
Hard Drivin'	4.99	Toyota Celica	5.99
Hitchhikers Guide	7.99	Ultimate Golf	5.99
International Ice Hockey	7.99	Venus Flytrap	5.99
James Pond	5.99	Voodoo Nightmare	5.99



DIRECT

8A, ACORN BUSINESS CENTRE
CUBLINGTON ROAD
LEIGHTON BUZZARD
BEDFORDSHIRE LU7 0LB

ORDER HOTLINE 0296 688222
GENERAL ENQ. 0296 682248
FAX 0296 682290

SPECIAL OFFERS

TITLE	PRICE	TITLE	PRICE
Airball	3.99	Pegasus	9.99
BSS Jane Seymour		Player Manager	9.99
(Inc FOFT)	4.99	R-Type II	9.99
Billiard II Sim	3.99	Rolling Ronny	9.99
Chase HQ	5.99	Shadow of the Beast	5.99
Chuck Rock	9.99	Soccer	3.99
Cougar Force	3.99	Snowstrike	3.99
Deuteros	9.99	Super Off Road Racer	7.99
Double Dragon II	5.99	Supremacy	12.99
Eco Phantom	3.99	Tank Attack	5.99
Electronic Pool	3.99	TV Sports Basketball	9.99
Flight of the Intruder	14.99	TV Sports Football	9.99
Frenetic	9.99	Tanglewood	3.99
Golden Axe	7.99	The Spy Who Loved Me	4.99
Goldrunner	3.99	Ultima V	9.99
Hunter	9.99	Viz	7.99
Jupiter Probe	3.99	Warzone	9.99
Khalaa	3.99	Winning 5	9.99
Lords of the Rising Sun	9.99	Wings 1 Meg	9.99
Mystical	2.99	Wolfpack	9.99
Omicron	9.99	Xiphos	3.99
High Energy (Tin Tin, North & South, Teenage Queen, Fire 'n' Forget, Hostages)	4.99	16 Bit Hit Machine (Supercars, Skidz, Switchblade, Axel's Magic Hammer)	4.99

AMIGA TOP 100

Title	Members Price	RRP	Title	Members Price	RRP	Title	Members Price	RRP
2 Hot 2 Handle	19.99	29.99	G-Loc	16.99	25.99	Police Quest III	25.99	39.99
4D Boxing	16.99	25.99	Godfather	19.99	30.99	Populus II	19.99	30.99
4 Wheel Drive	18.99	29.99	Heart of China	22.99	34.99	Powermonger Data Disk	11.99	19.99
A 320 Airbus	22.99	35.99	Heimdall	20.99	34.99	Project X	16.99	25.99
Another World	16.99	25.99	Harlequin	16.99	25.99	Quest & Glory	19.99	30.99
Agony	16.99	25.99	Hero Quest	16.99	25.99	Railroad Tycoon	22.99	34.99
Alcatraz	16.99	25.99	Home Alone	16.99	25.99	Realms	19.99	29.99
Alien Breed	16.99	25.99	Hook	16.99	25.99	Rise of the Dragon	25.99	39.99
Alien Storm	16.99	25.99	Hudson Hawk	16.99	25.99	Robocod	16.99	25.99
Barbarian II	17.99	30.99	Jimmy Whites Snooker	19.99	29.99	Robocop III	16.99	25.99
Bart Simpson	16.99	25.99	John Maddens	16.99	25.99	Rugby World Cup	16.99	25.99
Battle Isle	19.99	30.99	King's Quest V	25.99	39.99	Secret of Monkey Island II	19.99	30.99
Birds Of Prey	19.99	30.99	Knightmare	19.99	29.99	Shadowlands	19.99	30.99
Bitmap Vol I	16.99	25.99	Knights of the Sky	22.99	34.99	Silent Service II	22.99	34.99
Black Crypt	16.99	25.99	Last Ninja III	16.99	25.99	Sim Ant	16.99	25.99
Blues Brothers	16.99	25.99	Leander	16.99	25.99	Space Ace II	25.99	39.99
Board Genius	18.99	29.99	Legend	19.99	30.99	Space Crusade	16.99	25.99
Bonanza Bros	16.99	25.99	Leisure Suit Larry V	25.99	39.99	Space Quest IV	25.99	39.99
Castles	19.99	29.99	Lotus Turbo Challenge II	16.99	25.99	Special Forces	22.99	34.99
Celtic Legends	19.99	30.99	Life and Death	16.99	25.99	Storm Master	19.99	30.99
Championship Manager	16.99	25.99	Magic Pockets	29.99	40.99	Super Space Invaders	16.99	25.99
Chart Attack	18.99	29.99	Might & Magic III	29.99	40.99	Team Jaguar	19.99	30.99
Conan The Cimmerian	19.99	30.99	Manchester United Europe	16.99	25.99	Terminator II	16.99	25.99
Cover Girl Poker	16.99	25.99	Mega Twins	16.99	25.99	Test Drive II Collection	19.99	29.99
Covert Action	22.99	34.99	Microprose Golf	22.99	34.99	Titus The Fox	16.99	25.99
Cruise for a Corpse	19.99	30.99	Mig 29M Super Fulcrum	25.99	39.99	Top League	19.99	30.99
Daemonsgate	22.99	34.99	Moonstone	19.99	29.99	The Addams Family	16.99	25.99
Death Knights of Krynn	19.99	30.99	Monsterpack II	16.99	25.99	The Manager	16.99	25.99
Deluxe Strip Poker 2	16.99	25.99	Myth	16.99	25.99	TNT II	16.99	25.99
Dizzy Collection	16.99	25.99	Ninja Collection	16.99	25.99	Thunderhawk	19.99	30.99
Double Dragon III	16.99	25.99	Oh No Not More Lemmings (add on)	13.99	19.99	Ultima VI	19.99	30.99
Elivira II	22.99	34.99	Oh No Not More Lemmings (stand alone)	16.99	25.99	Utopia	19.99	30.99
Epic	19.99	30.99	Ork	16.99	25.99	Utopia Data Disk	9.99	19.99
Eye of the Beholder II	23.99	35.99	Outrun Europa	16.99	25.99	Video Kid	16.99	25.99
Final Fight	16.99	25.99	Paperboy II	16.99	25.99	Vroom	16.99	25.99
First Samurai/Megalomania	19.99	30.99	Parasol Stars	16.99	25.99	Wild West World	16.99	25.99
Flames of Freedom	22.99	34.99	Pitfighter	16.99	25.99	WWF Wrestling	16.99	25.99
F15 Strike Eagle II	22.99	34.99	PGA Courses	10.99	14.99	Wolfchild	16.99	25.99
Football Crazy	16.99	25.99	PGA Plus	19.99	29.99	World Series Cricket	19.99	30.99
Formula One Grand Prix	22.99	34.99	Pinball Dreams	16.99	25.95			
Gauntlet III	16.99	25.99						

(PLEASE CALL IF YOU CANNOT SEE WHAT YOU REQUIRE)

Regretably the items featured in this advert are available to club members only.
So enrol now to take advantage of the special prices.

**NO OBLIGATION
TO BUY**

JUST ENCLOSE £7.50 ANNUAL MEMBERSHIP FEE WITH YOUR INITIAL ORDER
AND RECEIVE THE FOLLOWING BENEFITS:

- FREE DISK BOX WORTH £8.99.
- SAVE HUNDREDS OF POUNDS ON RECOMMENDED RETAIL PRICES.
- UNBEATABLE SPECIAL OFFERS.
- FREE COLLECTORS CARD FOR EVEN MORE SAVINGS.
- 10% DISCOUNT ON GAMES AT OUR STAND AT COMPUTER SHOWS.
- MEMBERSHIP CARD AND PIN NUMBERS
- JOINING A CLUB WITH MORE THAN 10,000 MEMBERS WORLDWIDE

MEMBERSHIP DETAILS

**NO OBLIGATION
TO BUY**

FREE!

**80 CAPACITY
DISK BOX
WORTH £8.99**

HOW TO ORDER

PLEASE CHARGE MY ACCESS/VISA NO:

ORDER FORM

PLEASE SUPPLY ME WITH THE FOLLOWING:

TITLE	PRICE
MEMBERSHIP	£7.50
P&P	
TOTAL ENCLOSED	

DATE.....

NAME.....

ADDRESS.....

POSTCODE.....

TEL.....

EXPIRY DATE:.....

PERSONAL CALLERS WELCOME

PLEASE MAKE CHEQUES AND POSTAL ORDERS PAYABLE TO FX DIRECT AND SEND TO THE ADDRESS ABOVE

CREDIT CARD ORDERS TAKEN.
PAYMENT CASHED ONLY ON DESPATCH
UK ONLY PLEASE ADD £1.25 FOR THE FIRST ITEM AND AN EXTRA 50p FOR EACH ADDITIONAL ITEM. (OVERSEAS ORDERS WELCOME, POSTAGE AND PACKING DEPENDENT UPON DESTINATION)

Inevitably some of the titles featured may not be released at time of going to print but will be despatched as soon as they become available.

All prices subject to change without notice. E & O E.
All items subject to availability.
Please allow 5 days for cheque clearance.

The new, updated complete guide to the Amiga

CREATIVITY GUIDES

Get results by reading our advice on what software to buy in graphics, 3D, animation, DTP, digitisers, scanners, music, video, education, multimedia.

PRODUCTIVITY GUIDES

More buying suggestions and solid advice on the practical areas of word processing, databases, spreadsheets, accounts software, comms, programming.

INFO FOR BEGINNERS

Features to introduce the Amiga, explain how it works and get you started in any area of Amiga use including Workbench and the CLI.

HARDWARE EXPLAINED

Overviews of hardware and its functions, including buying recommendations on printers, emulators, monitors and more.

PUBLIC DOMAIN

The whole world of free and next-to-nothing software explained, explored and elucidated. The best in utilities targeted and the demos scene exploded.

WORKBENCH TECHNICAL TIPS

A whole host of interesting and useful advice and information, from hardware to software and back.

GAMEBUSTERS GAMES ADVICE

Including tips and hints for old favourites like *Rainbow Islands*, *Batman*, *Rick Dangerous*, *Dungeon Master* and *Shadow of the Beast 2* as well as some of the recent hits like the game of the year *Lemmings* and the amazing *Supercars 2*.

PLUS TWO COMPLEMENTARY DISKS FOR ONLY £4.00 EXTRA FEATURING:

JRComm communications package ● **Scenery** fractal landscape generator ● **Cruncher** compression utility ● **ScreenX** saves screens as pictures ● **Iconmaker** icon creator ● **SysInfo2** tells you what's in your Amiga ● **WhereIs** helps you find files ● **Border** switches off screen borders ● **ClickDOS** the power of CLI without the hassle ● **Safeboot** protects your games from viruses ● **ViewILBm** displays pictures easily ● **Quicklens** magnifies your screen! ● **WB Hacks** a bit of fun ● **MegaWB** scroll round a massive screen ● **FuncKey** customises key set-ups ● **ScreenShift** adjusts screen positioning ● **ZeroVirus** virus killer ● **Zap** binary file editor ● **BootIntro** adds intros to your disks ● **RSLClock** full toolkit ● **DropCloth** adds colourful Workbench screens ● **TaskControl** sets your priorities ● **SuperEcho** real-time sound processing ● **FPic** image processing ● **DropShadow** smartens your Workbench ● **DecHexBin** programmer's calculator ● **MandelMountains** excellent fractal creator ● **Spread** simple spreadsheet program

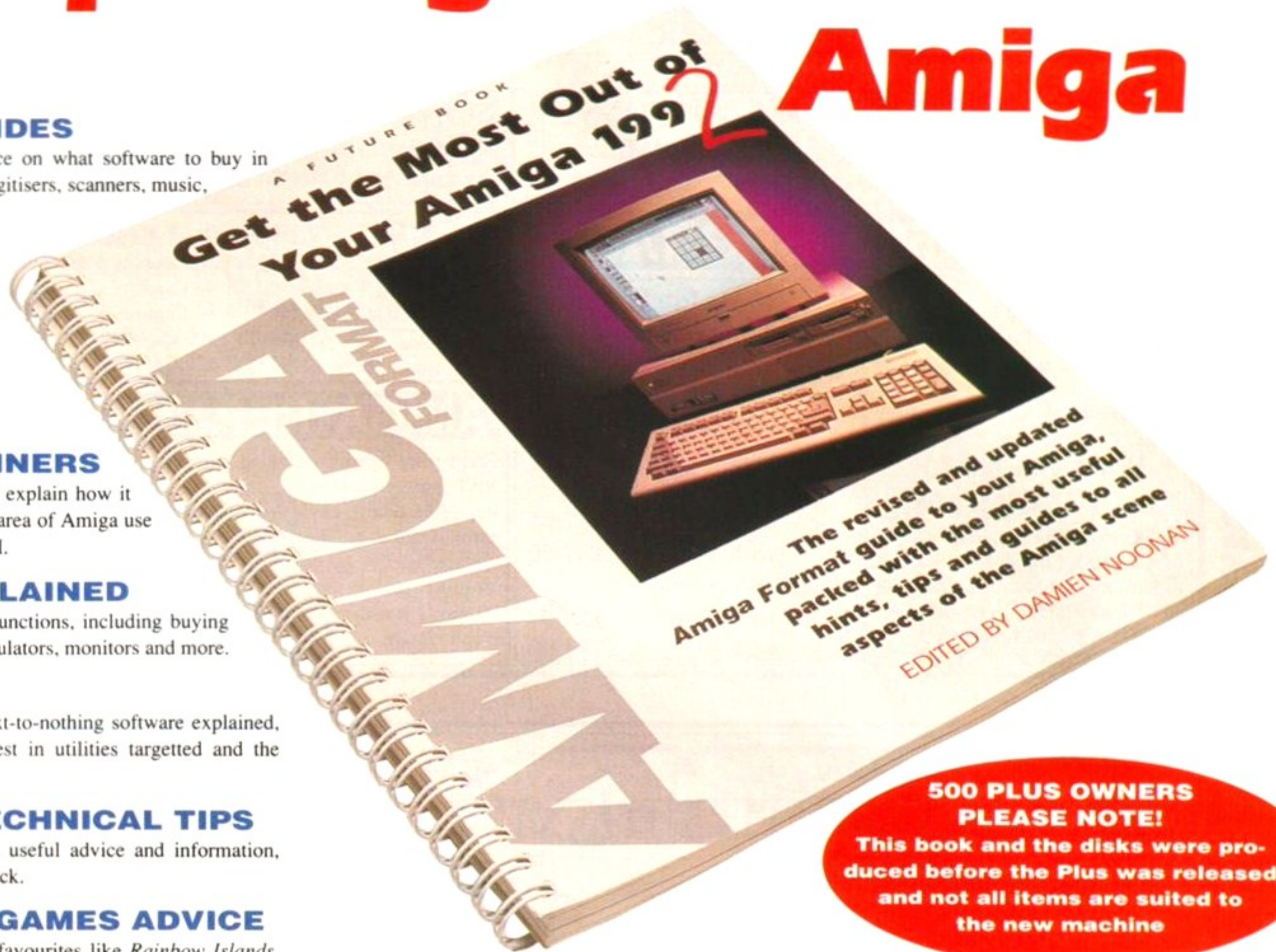

500 PLUS OWNERS PLEASE NOTE!
This book and the disks were produced before the Plus was released and not all items are suited to the new machine

Costing only **£9.95** and completely rewritten to include stacks of new information, this is the most comprehensive overall guide there is to every aspect of the Amiga and what to do with it.

ORDER FORM

I would like to order ___ copy/copies of
GET THE MOST OUT OF YOUR AMIGA 1992
at the price of **£9.95 (+1.45 per copy P&P)**

I would like to order ___ copy/copies of
GET THE MOST OUT OF YOUR AMIGA 1992
plus 2 disks for **£13.95 (+1.45 per copy P&P)**

If paying by cheque please send payment with this order form in a sealed envelope to:

AMIGA FORMAT GTM 1992 Book
FREEPOST
Future Publishing Ltd
Somerton, Somerset TA11 7BR

No stamp required if posted in the U.K.

Please allow 28 days for delivery.

Name _____

Address _____

Post Code _____

Telephone _____

I enclose cheque/PO for £ _____

Please debit my Access/Visa card: (delete as appropriate)

My card no. is _____

Expiry date _____

Signature _____



Factory Shop Open Mon - Sat Callers Welcome

"A500 PLUS" 1.0MB RAM UPGRADE

Realise the full potential of your Amiga A500 Plus with a V1000 1MB upgrade. The simple way to expand your Amiga to a massive 2MB CHIP RAM.

Simply plugs into trapdoor expansion - Top quality gold plated connector - socketed rams - 8 low power ram IC's - will not invalidate your guarantee - expandable in 1/2 MB stages

V1000 BEST PRICE EXPANSIONS

	0.0MB	0.5MB	1.0Mb
ONLY	£16.99	£29.99	£39.95

Maintain software compatibility on your A500 Plus with standard A500

KICKSTART ROM SWITCHER

machines. Switching from the Amiga keyboard between 1.3 & 2.04 ROMs thus allowing the full range of Amiga software to be run. This board can also upgrade standard A500s to 2.04.

Swapper only	£24.99
Swapper+ 1.3ROM	£49.99
Swapper+ 2.04ROM	£59.99

Kickstart 1.3	£29.95
Kickstar 2.04	£39.95
Gary chip 5719	£17.95
Fatter Agnus 8372A	£49.95
CIA chip	£14.99
RAM chips 1/2 Mb	£17.59

A500 PLUS SPECIAL OFFER

A500 Plus 1MB upgrade + Kickstart ROM switcher + Kickstart 1.3 ROM

ONLY £85.00

AMIGA A500 UPGRADES

Tired of "OUT OF MEMORY" errors? Dissatisfied with limited D-Paint animations? Frustrated at being unable to print at full resolution? Or simply want to release all those inaccessible features in your favorite game.

What you need is more CHIP RAM!

Unlike some other manufacturers all of Virgo's trapdoor memory expansions are fully compatible with CHIP RAM and are available at the best prices you will find.

From 1/2 Mb to 4 Mb

V500 1/2 MB	£17.99
V501 1/2 MB + clock	£22.99
V1500 1 1/2 MB + clock	
bare board	£32.95
with 1 1/2 MB	£69.99
V2000 2MB + clock	
bare board	£37.95
with 2MB	£97.50
V4000 4MB + clock	
bare board	£59.00
with 4Mb	£188.00

Disks

complete with labels

3 1/2" DSDD	£5.45 for 10
Branded DSDD	£6.80 for 10
3 1/2" DSHD	£6.75 for 10

3 1/2" LOCKABLE DISK BOXES

10 Capacity 5 for	£5.95
40 Capacity	£5.62
80 Capacity	£6.99
100 Capacity	£8.34
120 Capacity	£9.52

Amiga dust cover	£3.50
Mouse Mat	£4.25

AMIGA REPAIRS

Fixed price repairs including parts, labour, VAT, post & packing.
Repair of disk & keyboard included (£24.50 extra if these are unrepairable and require replacement.
Virgos Upgrades fitted free with repair.
90 day guarantee on all repairs.

ONLY £44.50

Joysticks - Mice - Printers Monitors - Amigas

Same day dispatch whenever possible. 1-year guarantee on all products. Prices may change without notice.

ALL PRICES INCLUDE VAT and P&P. NO HIDDEN CHARGES

AMIGA FORMAT

208

JUNE 1992

DATASTREAM PD

Tel: 0276 677099
Open 10.00 to 20.00 Mon - Sun

GAMES

G0153 Air ace ii	G0989 Master of the town
G0125 Air warrior	G0367 Megaball
G0368 Amos-Defence	G0657 Missile command
G0386 Asteroids	G0743 Monopoly
G0423 Auto bahn 3000+	G0832 Napoleonic war simulator
G0551 Arcadia	G0450 No man's land
G0487 Atic atac	G0488 Pacman 87
G1093 Battleforce	G0798 Paranoid
G0549 Battle pong	G0911 Pom pom gunner
G0434 Block it	G0033 Quattro
G0398 Castle of doom	G0154 Return to earth
G0602 Cave runner	G1184 Scramble
G0729 Chess	G1001 Scum haters
G0194 Dark staff	G0867 Sealance (sub sim)
G0675 Downhill Skiing	G0195 Seven tiles
G0441 Drip	G0346 Simpsons
G0399 Dungeon master extravaganza	G0962 Space Invaders
G1866 Electric train set	G0198 Star trek (1M)
G0945 Emerald mine 2	G0049 Star trek (2 drives)
G0855 Flascheiber	G0830 Star trek C
G0684 Frantic freddy	G0362 Star trek next generation
G0998 Fruit machine	G0293 ST bash
G0196 Ghost ship	G0892 Super skoda challenge
G0360 Golden fleece	G0227 Tennis
G0721 Imperium	G0889 Tetris
G0128 Jetman	G1950 Tritis
G0241 Legotris	G0122 Twintris
G0270 Lettrix	G0973 Wizzy's quest
G0693 Llamatron	G0583 Xenon
G1006 Lore of conquest	

UTILITIES

U0389 A-Gene (1M)	U1040 Last Hope
U0354 Amibase	U1634 Littlebench
U0532 Arp (WB1.3.2)	U1522 Master Virus Killer
U1644 Bankin	U0354 Moad
U2066 Biorythms	U0675 Med (2)
U2036 Business card maker	U1837 MessySid
U1424 Catalogue maker 2D	U0928 MSH (MessyDOS)
U0256 C64 emulator	U1069 NComm
U1774 C Manual 3D	U1982 Nib Copier
U2088 C:Commands	U0755 North C
U2050 C-Light	U0134 Picturessque
U1412 Cursor Basic Compiler	U0626 P Suite
U1213 D Copy	U0958 QL Emulator 3D
U1732 Deskbench	U0075 Quickbase
U0167 Desk top Publisher	U0683 Quickbench (1M)
U0278 Dice 2D	U0494 Red Devil
U0397 Diskmaster	U1394 Rim Database
U0204 Diskprint	U1677 Sid
U1275 Draw Map	U0851 Spectrum Emulator
U1552 Electrocad	U0649 Speedbench (1M)
U2849 Flexibase	U1579 Spellchecker
U2532 Fortran 77	U0398 Starchart
U2359 GFX	U1540 Super Killers
U1782 Home Utilities	U0736 Textplus Word processor
U1091 Icon Magic	U0873 Transformer
U0830 Interferon Pro	U0652 Turbo Imploder
U0367 Journal	U0435 Visicalc
U1548 JRCComm	U1314 Windowbench 2D
U0972 KO The Virus	U1225 Word frenzy

ANIMATIONS

A0152 Amy vs Walker (1M)
A0035 Batman (1M)
A0134 Bugs Bunny (1M)
A0068 Dragon's Lair (1M)
A0172 Fractal Flight (1M)
A0089 Fighter Plane (1M)
A0197 Iraq (1M)
A0046 Star Wars (1M)
A0051 Walker 1 (2M, 2D)
A0146 Walker 2 (2M, 2D)

MISC

M0047 Amateur Radio 5D
M0093 Bible (4D)
M0128 Business letters
M0129 Mandelbrot Generator
M0748 Morse
M0749 Starchart
M0058 Tarot (2D)
M0077 Typing Tutor

Disk Prices:

1 to 10 disks £1.20 each
11 or more disks £1.00 each
Note (2D), (3D) means 2 disks or 3 disks etc.

DEMOS

D0482 Addams Family	D0465 Franklin the Fly
D0373 Agony Demo	D0287 Laurel and Hardy (2D)
D0256 Alcatraz (3D)	D0149 Legend of Billy the Kid (1M)
D0348 Amaze	D0230 Monty Python (2D)
D0136 Another five ways to kill a mole	D0377 Probe sequence
D0423 Beastie Boys	D0295 Puggs in space
D0246 Budbrain 2	D0173 Pink Floyd The Wall (6)
D0258 Cronics (1M)	D0253 Red Sector (1M, 2D)
D0189 Deadly Pursuits	D0345 Shark (1M)
D0266 Elvira	D0297 Shuttlecock (1M)
D0344 Fillet the Fish	D0169 Simpsons Demo
D0523 Five ways to kill a mole	D0256 Thunderbirds

ORDERING

Ordering by Post:

Please write down the catalogue number for the disks that you require, send them with your name, address and payment made out to "DATASTREAM PD" to:-

Payment

Please make cheques and postal orders payable to "DATASTREAM PD" or phone with your credit card number. ALL prices include VAT and P&P.

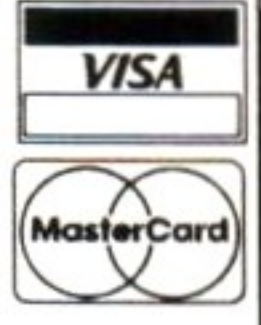

Datastream PD, P O Box 44, Camberley, Surrey, GU15 2TL

You deserve the best!

Now you can get the best... with PEN PAL!

A superb package, with immense power, to fulfil all your word processing requirements and... it includes a Database! It's all so easy to use, you probably won't need to refer to the extensive 250 page manual too often.

Whilst working, you can open up to four documents simultaneously (memory permitting), search and replace; cut, copy and paste; check your spelling with a 100,000+ word dictionary. You can import your favourite IFF/HAM graphics, from programs such as DPaint II or Clip Art files in various sizes and colours. You can automatically flow text around graphics in any Workbench compatible font (there are over 200 available styles), in different sizes and colours to suit your design... even as you type. All this from a word processor and... Much, Much, More!

As you can see, this is not just any ordinary word processor! Full Page View with position, edit and creation of graphic objects. Mail Merge using the built in database and forms designer. Creation of templates for complex reports, into which the database can be merged.

Operating with 32 fields per record, and 32,000 records per database with a fast sort of 1000 records in less than 5 seconds this is a *real* database.

Pen Pal requires an Amiga 500/1500/2000 or 3000 with a minimum of 1 megabyte of available memory.

Pen Pal

When...you deserve the best!

£79.95

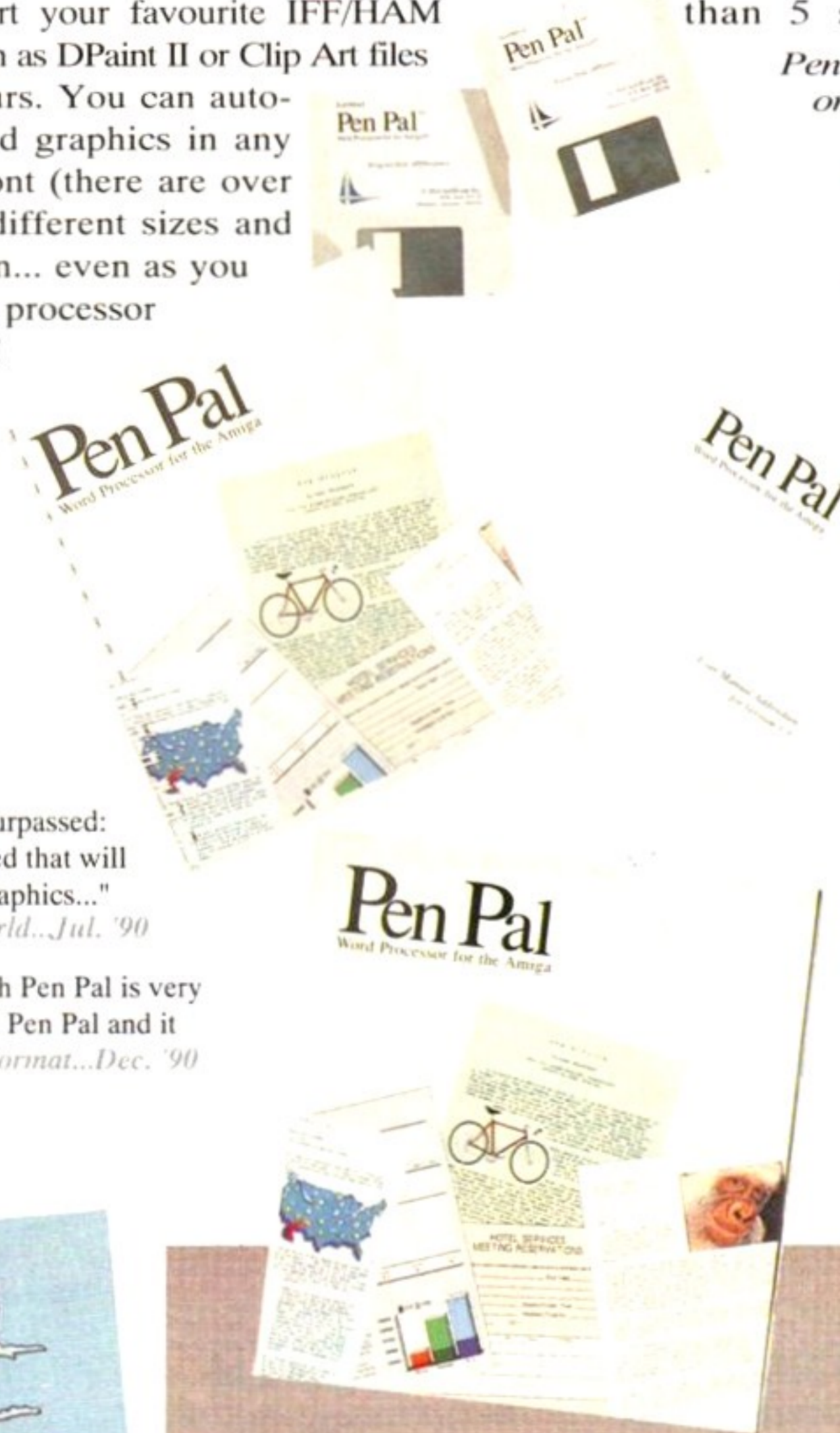

"...its handling of graphics is unsurpassed: Pen Pal is the only program I tested that will automatically wrap text around graphics..."

Amiga World...Jul. '90

"...without beating around the bush Pen Pal is very special.. - "There is little to fault Pen Pal and it deserves to do well."

Amiga Format...Dec. '90

"...I am extremely pleased with your product especially the Graphic Capabilities within the Word Processor. Having the Database on the same disk has made PEN PAL the best program I have..."

D.S.B., Plumstead, LONDON

"...Please let me tell you how amazed I am at how EASY IT IS TO USE PEN PAL. The manuals supplied are very informative and very clear..."

P.S.S., Clifton, NOTTINGHAM

"...A most excellent piece of software..."

E.P.H., Strathclyde, SCOTLAND

Gordon Harwood Computers
New Street
Alfreton
Derbyshire
DE5 7BP.

Dear Sirs,

Hi! I am writing this letter using "Pen Pal". Normally I do not correspond with computer companies, but this time I had to make an exception.

I have been looking for a program that I could use to create colourful letters, useful forms, and effective business graphics. I have purchased several Amiga word processors whose ads made great claims as to their capabilities. After using these programs, however, I found that the ads were only hype! I soon began to feel that no program would do what I wanted to do.

Recently I saw your program "Pen Pal" on my dealer's shelf. According to the package I thought that I might finally be in luck. Although I purchased the program I was afraid that in reality it would not do everything the package said it would do.

As soon as I got home from the computer store I fired up the program on my computer. Without even reading the manual I was soon creating documents with colour and pictures. As you can see from this letter, I have become pretty good at your program's graphic capabilities.

One pleasant surprise I had was to discover that Pen Pal has a built in database manager. I find that I use this database almost as much as the word processor. I have entered my Christmas mailing list, video tape library, and cooking recipes in it. When I send Christmas cards this year I will use Pen Pal to print the mailing labels. I am designing my own Christmas cards in Pen Pal including colour pictures I draw in a paint program. I plan to use Pen Pal's mail-merge feature to merge my mailing list names with the card to make each one personalised.

Thank you for making this program available.

Mr. Richard Goodwin

Man's (and Woman's) Best Friend

Pen Pal Order Line

0773 836781

Pen Pal is also available from good computer stores everywhere!

FINANCIAL REPORTING COMPANY

Financial Report to Division Managers

	1987	1988	1989	1990
OPERATING EXPENSES				
Cost of sales	280,120	28,180	387,358	36,298
Selling, general, and admin.	264,429	97,188	495,948	167,834
Research and development	46,569	14,875	89,667	26,299
Income from operations	312,384	112,521	585,386	285,298
Equity in loss of S.M. operations (15,891)	7,247	5,222	(29,812)	18,077
Interest income	282,048	117,868	574,398	211,521
Provision for taxes	113,588	51,888	212,588	91,188
Net Income	198,348	68,862	354,898	129,431
Net Income per share	58.17	58.84	58.31	58.11

... and they are better than expected!

In the first quarter of 1988 each division took advantage of strong economic conditions in their respective territories to post sales figures well in excess of their goals.

Trade Distributors...

SDL

JJ Precision Software

S CENTRESOFT

HBM HB MARKETING

Pen Pal is supplied into the UK through...

Gordon Harwood Computers New Street Alfreton Derbyshire DE5 7BP
Telephone: 0773 836781 Facsimile: 0773 831040

GORDON HARWOOD HARWOOD HARWOOD

Computers

Ladbroke Computing International

**33 Ormskirk Road
Preston
Lancashire
PR1 2QP**

**Telephone:
(0772) 203166
Fax:
(0772) 561071**



Ladbroke Computing are the longest established Atari dealer in the UK. We have developed an extensive customer service policy which means that we test all hardware prior to despatch to ensure that goods arrive in working order. Although our prices are not always the cheapest we do endeavour to offer consistently good service and backup. This isn't just our opinion, we were voted 'Best Dealer 1989' by the readers of ST World magazine, not for 'the number of boxes shifted', but for quality service.

All prices are correct at copy date 09/04/92 (while stocks last), and are subject to change without prior notice. Please phone for up to date prices. All prices include VAT & delivery (in mainland UK), there are no hidden extras (WYSIWYG). Next day courier delivery is available for an extra £7 (Mainland UK). All prices available on Mail Order. Shop prices may differ. Shop & Mail order premises: 33 Ormskirk Road, Preston, Lancashire, PR1 2QP. Open Monday to Saturday 9:30am to 5:00pm. Phones answered from 9:00am. Dealer enquiries welcome. Ladbroke Computing International is a trading name of Ladbroke Computing Ltd. All trade marks recognised.

Due to limitations of space we cannot list all our products please phone for Diskboxes from £6.99, Amiga Workstation £49.99, ICD Ad-Speed £189.99, Dustcovers from £3.99, Phone for details of our repair service (ST & Amiga) Repair quote £15. Phone for more details.

Golden Image

£24.99

£19.99 without software

The NEW Golden Image *Brush* Mouse

- 150 Dpi resolution
- 500mm/SEC Tracking speed
- Switchable between ST/Amiga
- Opto/Mechanical Mechanism
- Includes Deluxe Paint III software
- Direct mouse replacement

Hand Scanners

- Golden Image Hand Scanner £149.99**
A 100, 200, 300, 400 Dpi hand scanner with 64 halftone levels for three different halftone mode settings and one letter mode. The scanner comes complete with the acclaimed Touch Up software and Deluxe Paint III Art package.
- Jin Scan Hand Scanner £119.99**

Golden Image Drive

- Digital Track Counter
- Daisy chain "through" connector
- Data enable/disable switch
- Only £54.99 including P&P

GVP II Hard Drives

GVP II A500 Hard drives include injection moulded styling, Internal RAM expansion to 8Mb via SIMM boards, Capacities from 52Mb, 3.5" 11ms Quantum mechanism, Internal Fan, Game switch and mini slot for future expansion.

- GVP 52Mb £379.99**
GVP 105Mb £559.99
GVP 52Mb + 2Mb Simms £449.99
GVP 52Mb + 8Mb Simms £689.99

RAM

Golden Image 512K Upgrade with clock £27.99

Phoenix 1Mb Board (A500 Plus only) £49.99

CDTV

£479

Phone for: Ultimate Basketball, Faicon F16, Fun School 3, Dr Wellman, Defender of the Crown, Chaos in Andromeda, Psycho Killer, World Vista, Advanced military systems, Illustrated Holy Bible.

Monitors

- Protar Visto Col Mon £219.99**
Includes cable and 12 months on site replacement warranty.
- Philips 15" Cube TV £269.99**
A 60 channel, FST, Fastext scart input TV which gives near monitor quality. Includes scart cable.

Disks

- 10 bulk disks £4.94
40 Bulk disks £18.80
100 Bulk disks £41.13
80 disk box £7.99
250 disk box £19.99

Atari Lynx 2

- Lynx 2 (Console only) £79.99**
Lynx soft cases £9.99
New Battery pack £9.99
- Lynx 2 Power supply £11.99**
Comlynx cable £6.99
Lynx 2 sunvisor £5.99
- Phone for: Klax, Ultimate chess, Robotron, Shanghai, Chips challenge, Xybots, Roadblasters, Chequered flag, Ninja gaiden, Paperboy, Turbo sub, Xenophobe, Qix, Robo squash, Tournament cyberball, Ms Pac Man, Bill and Teds excellent adventure, APB, Warbirds, Scrapyard dog, Stun runner, Hard drivin, Sime world, Electrocop.

Genlock

- Roctec Genlock £109.99**
Rocgen + £179.99

Amiga Packs

- 1Mb Cartoon Classics Pack £339.99**
Includes: A500 Plus computer with 1Mb on board RAM, mouse, modulator, Workbench 2, Lemmings, Captain planet, Simpsons, Deluxe Paint III.
- 1Mb Cartoon Classic Extra Pack £379.99**
Includes: 1Mb Cartoon Classics (as above), Datastorm, Dungeon Quest, E-Motion, Monster grand slam, Kid gloves, Powerplay, RVF Honda, Shuffle Puck cafe, Microprose Soccer, Tower of Babel, GFA BASIC, 10 disks + box, Mouse Mat, Dustcover, Apache 1 joystick.
- Bare Amiga 1.3 version+Astra Pack £299.99**

Printers

- Star SJ48 Bubblejet £239.99**
Star LC-20 £139.99
Star LC-200 colour £199.99
Star LC-24/20 £199.99
Star LC-24/200 £229.99
Star LC-24/200 colour £289.99
- All Star printers include 12 months on site warranty.
All printers include ST/Amiga/PC compatible Centronics cable.

Mice

- Golden Image Opto Mechanical Mouse, 250Dpi, switchable between ST/Amiga £17.99**
Golden Image Optical Mouse, 250Dpi, Mouse mat, no moving parts for greater reliability, switchable between ST/Amiga £34.99
Jin Mouse, High quality replacement mouse £12.98

Sega Megadrive £105
Includes Keypad controller.
Phone for Games

HOW TO CONTACT AMIGA FORMAT

You can be certain of getting your enquiry to the magazine dealt with only if you make quite sure you're addressing your letter to the right person or place.

- We can never give personal replies by mail, so don't send us a stamped-addressed envelope.
- We can under no circumstances give personal replies by fax, so please don't ask us to.
- We are available for enquiries by telephone every Tuesday between 10am and 6pm, and we'll be happy to talk to you then.
- Our advertising department can help with problems with companies who advertise in the magazine if you phone during normal office hours.
- Our subscriptions service and the *Amiga Format* Mail Order department are not in the same building and can be contacted on 0458 74023.

WORKBENCH

If you have any problems with the technical side of your Amiga, with hardware or with serious software, Pat will try to answer you in the mag. Alternatively, if you have any advice for others or any handy tips to share, send it in and you could win a prize.

WORKBENCH,
AMIGA FORMAT, 30 MONMOUTH STREET, BA1 2BW.

GAMEBUSTERS

If you've just found the cheat mode, mapped out the levels or found all the passwords for the latest game, send it in to Maff and you could win a prize. Or if you're stuck, ask Helping Hand for advice – or solve someone else's problem and win a prize!

MAFF EVANS, GAMEBUSTERS
AMIGA FORMAT, 30 MONMOUTH STREET, BA1 2BW.

LETTERS

The Letters pages are for you to air your views and share your opinions: please remember not to ask questions that should be in Workbench! Damien is looking for thought-provoking or entertaining letters, the shorter the better. Prizes for the best two.

LETTERS TO THE EDITOR
AMIGA FORMAT, 30 MONMOUTH STREET, BA1 2BW.

COMPETITIONS

To enter a competition, write the answers and your name, address and phone number on the back of a postcard or a stuck-down envelope and send it in. You can enter as many times as you wish, but all entries must be posted separately: don't put several entries in one envelope together, or include entries with letters to any other part of the mag.

COMPETITION, AMIGA FORMAT,
29 MONMOUTH STREET, BATH BA1 2DL.

SPECIAL OFFERS

If you've ordered anything from the *Amiga Format* Mail Order section and you've got a problem, please remember that we on the magazine don't deal with it at all. Write to them at our Somerton address or phone 0458 74011.

AMIGA FORMAT MAIL ORDER,
THE OLD BARN, SOMERTON, SOMERSET TA11 7PY.

SUBSCRIPTIONS

Similarly, if you move house and want to make sure your copy of the magazine catches up with you, then send the new address to

AMIGA FORMAT SUBSCRIPTIONS, THE OLD BARN,
SOMERTON, SOMERSET TA11 7PY.

FAULTY COVERDISKS

The disks are duplicated and stuck on the magazine by a firm who we employ for that specific purpose. If you have a faulty disk, send it to them enclosing an SAE. We don't keep stocks of disks, so we can't help. DISKCOPY LABS, UNIT A, WESTMARCH, LONDON ROAD, DAVENTRY, NORTHANTS, NN11 4SA.



Letters

Hello and welcome, once again, to the part of the magazine where you get to air your views, see your name in print (if you're lucky!) and find out what's on the minds of your fellow Amiga owners up and down the country and around the world. It's Editor **Damien Noonan** here, and I have to admit this month I've been taken aback by the sheer quality of your letters: almost every single one has had something worth printing in it. But we've had to whittle it down to the select few...

IDEAS MAN

A few suggestions. One: how about page numbers on every page. It's frustrating that you have a concise index but not enough page numbers to make it useful.

Two: Coverdisks. Just a small point, but when they arrive they are generally write-enabled and it seems easy to accidentally write to or erase them.

Three: establish a reader's marketplace. Cheap ads section for readers who want to buy/sell particular hardware and software, as well as unusual requests.

Finally, I heard a whisper that Commodore's next major upgrade might include the soundchip to either 16 voice or 16-bit. Is there any truth in the rumour?

**Andrew Thompson,
Petersham, NSW, Australia**

All interesting ideas and we do consider these things – but. One, we have been trying to put page numbers on as many pages as possible, but all too often the design of an advertisement does not leave room for one.

Two: the disks have to be write-enabled when they are copied, naturally, so we'd have to pay someone to switch them all the other way: hardly worthwhile, when it only takes you two seconds to do it yourself.

Three: we considered a classified ads section when we first started the mag three years ago, but in our experience all people used them for was software-swapping contacts, and surely it's easier to get secondhand stuff locally, out of a local paper?

There have been heaps of rumours about new Amiga developments lately. We've got no definite news but a new 16-bit four-channel Paula soundchip is very likely indeed.

Other rumours on the Amiga scene are as follows.

An Amiga 4000 (68040-based A3000-style workstation, possibly with 24-bit graphics), which is pretty likely; a new range of RISC-based 32-bit machines, which is possible but it would be a big step; and the new high-density disk drive which will double the capacity of floppies, which is almost certain. And even after the A600 there are stories of the medium-sized A800 and the cut-down A300...

THE PROBLEMS GO ON...

In Issue 29 of *Amiga Format* you had a list of software that worked on the new Amiga 500 Plus. One of the games on the list was *Dungeon Master*, which is one of my favourite games, but it doesn't work!

Richard Mann, Retford

Unfortunately, we can't absolutely guarantee that every game on the work/don't work lists will necessarily work or not work on the A500 Plus.

We did our best to get you as much information as possible when everyone concerned was trying to gloss over the subject, but we don't have the manpower to check all those lists ourselves so all the info is what someone else has claimed: we can't guarantee that it's gospel truth.

...AND ON

A warning to people who are tempted to buy a ROM sharer. I bought a Phoenix with a 1.3 chip on it for my 2.04 A1500 and admittedly some of my older 1.3 stuff ran on it, but I bought *Combo Racer* (A500 Plus compatible) and it wouldn't load.

Continued overleaf

OUR MISTAKE

In our January issue we published a letter which purported to be from a Mr Jim Towler of Withemsea and which made certain comments about the WH Smith shop in the Prospect Centre, Hull and its manager, Mr B. Haigh. We now realise that this letter was a hoax, it was not written by Mr Towler, and the facts mentioned were untrue and without any foundation whatsoever.

We apologise unreservedly to Mr. Towler, Mr Haigh and WH Smith Ltd.

I took it back to the shop, who tested it on a 1.3 and a 2.04 machine and it worked fine on both. If you are upgrading to 2.04 remember that you might not be able to run old or new software if you buy a ROM sharer.

M Barker, Hull

The manufacturers of ROM sharers do not claim that it will cure all problems: only some compatibility problems are down to Kickstart compatibility, not all of them. Your problem in this case might be to do with the fact that you've got an A1500. Unfortunately the situation is now immensely complex and shows no real sign of getting any easier.

UPGRADES AND SEXISM

I have re-read the article in **Amiga Format**. I have even asked for advice in a local computer shop which concentrates on Amigas, but I am still muddled as to whether or not I should upgrade my Amiga to Workbench 2. It seems not.

On the subject of why fewer women buy and use computers. Girls are loved and rewarded when they behave in a passive, background manner. Boys are rewarded when they are successful and aggressive.

Women have less money and less time than men. They cannot afford computers, let alone take time off from cooking and housework to actually indulge in enjoyment. They are made to feel guilty if they indulge in 'non-feminine ways'. Your magazine is very male-orientated, but then that is fair enough because they are the majority of readers.

Joanna, East Exeter

It's my personal view that the immense cost of upgrading to the new Workbench is simply not worth it. Most people get by with the old Workbench or never use it, most will never use the new screen modes that the enhanced Denise chip provides.

The only argument in favour is the extra Chip RAM offered by the new Fatter Agnus, which is good for sound sampling and animation and is beginning to be used by clever games programmers, like Andy Braybrook in Fire and Ice. But it still causes compatibility problems.

I'm still fascinated by the whole sexism debate. We do seem to be getting an increasing response from female readers. I read in the paper only the other day that not only do men believe that they are more intelligent than women, but also most women believe that men are more intelligent too. This is despite evidence going back as far as 1912 that there is no difference, although girls tend to develop more quickly in verbal skills, whereas boys tend to take the lead in maths and spatial awareness.

There's evidence too that girls tend to give way to boys when it comes to getting time at the computer in schools. On the other hand, I think it's much more difficult in current society for men to behave in 'feminine' ways than vice versa. The problem, surely, is with the people who think that computers are a boys-only hobby, which is clearly no longer the case.

SPOTTED!

I spotted an Amiga in, of all things, a Conservative party political broadcast. Amigas are going up in the world, eh?

Alexander J Cross, Leeds

That's astonishing, but I'm afraid I have to see this one to believe it. Anyone got a videotape of this party political broadcast? Not too likely, I suppose...

WHY LETTERS?



In your last issue you were asking why people are so keen on the Letters pages. I have a few suggestions. The Letters and Workbench pages are an easy way to get into reading the magazine – they are short and usually interesting bits and pieces that are like a starter before the main meal.

The Letters pages make one feel a part of a wider Amiga-owning community – a member of the club.

When I read the letters I feel involved in the discussion – there are two parts to the page, the letters and your replies to them. Add the reader and maybe there are three parts – so one feels stimulated and involved.

It's interesting to know what other people think. Maybe it's also like drama – measuring ourselves and our ideas up to those of other people. It's reassuring to know that other people have the same concerns as you.

And why am I writing this letter? In response to your question. The fact that I want to write in is because the Letters pages open up the possibility of dialogue and discussion and it's nice to get a chance to express your views. And there's always the prize!

Hamilton Bailie, Totnes

I begin to be convinced. Let me come clean about why this bothers me so much. The problem I have is this, you see. I am constantly trying to make sure the magazine gives as much value as possible (I know it's expensive, and that's a lot to live up to).

In the case of a computer magazine, the most key thing we do is give information – whether you should buy the latest new products, how to get more out of your machine, how to solve a problem you're stuck on. It's therefore difficult for me to accept that people want less value in those terms – the letters are mostly opinion and comment, rather than hard information.

One thing I must say is that I enjoy putting these pages together. It's nice to stay in touch with what people are thinking. You say a lot of nice things about the magazine, though it's generally our policy not to print flattery! I enjoy the chance to write something less useful and more discursive. And I also find the Letters pages often crystallise the opinion of the magazine on certain topics: like the WB2 upgrade debate, for example.

FOXX FANATIC

Back in **Amiga Format** 26 I read with great interest your article on Making Music with the Bitmaps, as it featured information on Nation 12, newly formed by Ultravox founder John Foxx and ex-Fall member Simon Richards.

I'm an avid fan of John Foxx and his music so I bought *Gods* to hear the soundtrack "Into the Wonderful", which was brilliant. I wrote to the Bitmaps to find out more about Nation 12 but, alas, no reply. Was the Nation 12 album ever released?

Carl Thompson, Leeds

We haven't heard anything about the album, but your best bet is to contact the record company Rhythm King who are on 071-372 3959.

PC WHINGE

I am a PC owner who happened to come across December's issue of **Amiga Format**. I was appalled to read such utter rubbish from computer professionals. Your article about Amigas being better "home computers" and more "sophisticated" than PCs is far from the truth.

Companies like Sierra, Origin and Lucasfilm are making games with 256-colour VGA graphics and 32-channel stereo Roland MT-32 sound on the PC first. Then they make cut-down versions for the Amiga.

The PC has been around since 1980 and will continue to advance far more than the Amiga. The PC has had over eight graphics cards and eight sound cards since its beginning.

Christopher McClon, Leatherhead

Utter nonsense. The PC design is archaic – you admit yourself it's been around since 1980, it's all based around a single CPU unlike the Amiga's custom chip architecture and it doesn't multi-task.

Yes, 386 PCs are good, but how much does one cost with a VGA monitor and a decent sound card? At least three times the price of an Amiga set-up, I think you'll find.

PCs are clumsy and complex to use – Peter

Molyneux of the programming team Bullfrog was telling me not so long ago that it took him all day to set up his new 386, and he's an experienced computer programmer! PCs also suffer from this massive range of different graphics and sound standards, which makes it incredibly difficult to know if a game will work to full effect on your system..

Finally, all these impressive games being created by these American developers are all very exciting, but they need a ludicrous amount of hardware. Most are only usable if installed on a hard drive, some using as much as 20 Mb of hard disk space. Crazy! If you want games with that kind of emphasis on huge graphics, surely the Amiga CDTV CD-ROM system is a much better option.

No, I'm sorry. I know that these fast PCs with all the trimmings are pretty impressive, but when you consider the cost and the hassle they simply don't hold a candle to the Amiga.

HELP!

My son and I are proud owners of an A500 Plus. From what I read in magazines and from what two friends who have the new machine say, there seems to be big concerns over the amount of software that won't run on it. Surely Commodore can supply owners of this machine, especially under guarantee, with something like the Phoenix ROM sharer?

S Jarvis, Wallington

Right, this particular subject is beginning to irritate me. Listen carefully, all you A500 Plus owners: I want you to do something about it.

The subject of compatibility (certain software not working on the A500 Plus) is clearly continuing to cause great concern and confusion to Amiga owners. Which upsets me. However, it is not really in my power to solve the problem.

Amiga Format has consistently attempted to bring you, the Amiga owner, as much information as possible about this problem. But we can't do everything. Now, Commodore will, quite reasonably, tell

Continued on Page 214

Third Reich

£29.99 by Avalon Hill Games Company

Wizardry VI

Bane of the Cosmic Forge

OFFICIAL CLUE BOOK £12.99 £35.99

Due March
DREADNOUGHTS
From Peter Turcan

Dreadnoughts... (Game).....£31.99
Ironclad Scenarios.....1894-1916.....£16.99
Bismarck Scenarios... WW2.....£16.99

HARPOON Special

Plus Battlesets 1&2 Amiga £31.99

Harpoon BATTLEBOOK (300+ pages) £ 16.99
Battleset #2 "North Atlantic Convoys" £22.99 import
Battleset #3 "The Med Conflict" £14.99
Battleset #4 "Indian Ocean" SOON
Scenario Editor..... £19.99

Strategic Plus Software

VISIT our SHOP in Hampton Hill
or send for our 7th Edition CATALOGUE.

Mail Order and Overseas orders welcome.

Phone 081 977 8088 Fax 081 977 4822

28 D&E The Courtyard, High Street, Hampton Hill, Middx. TW12 1PD.

Matrix

Buy Your Software From Us And We'll Buy It Back!

As a member of the Matrix you can choose from our extensive lists of the latest and the popular with our absolute guarantee to buy them back. AND you don't have to pay until you're decided.

- ★ Top name games, business and utility software (sorry no PD or Shareware)
- ★ Great prices ★ No commitment to buy ★ Computer helpline
- ★ Super fast service ★ - established 1981 - over 2½ thousand members.

To find out more about the unique Matrix money saving scheme
call our 24 hour hotline, (0920) 444224, now!

or send large s.a.e. stating your machine (IBM/PC 3.5", Amiga, Atari ST) to:- Matrix Leisure Services,
Dept AMF6, Unit 4, Mill Studio Business Centre, Crane Mead, Ware, Hertfordshire, SG12 9PY

1/2 price first years membership subscription!

AMIGA WORK CENTRE

- MONITOR STAND
- SPACE FOR 3 1/2" & 5 1/4" DRIVES
- ALLOWS HARD DRIVE
- DOES NOT BLOCK ANY PORTS
- EXTENSION LEADS UNNECESSARY
- FITS BOTH A500 & A500+



GET YOUR DESK SPACE BACK AND
GET SERIOUS

ONLY £29.95 INCLUDING
POSTAGE, PACKING &
INSURANCE.

CHEQUES & PO's TO:

MISDEM METAL BOX
UNIT 3, CARVER BUSINESS PARK
ASTONFIELDS INDUSTRIAL ESTATE
STAFFORD . ST16 3HR
TEL 0785 42796

..... dealer enquiries welcome

OPEN ALL HOURS

9am - 10pm Mon-Sat
10am - 6pm Sun

HARDWARE

A500 Plus + software£349
A500 512K.....£299
A1500 + software£565
1084S monitor.....£237
Phone for 2000 and 3000 prices

ACCESSORIES

Amiga int. drive.....£49.00
Cumana ext. drive£53.00
Zydec ext. drive£49.00
512K upgrade with clock£27.90
512K upgrade no clock.....£24.90
1.5Mb upgrade with clock.....£77.00
1Mb Amiga Plus upgrade.....£46.99

DISKS with labels

UNBRANDED BULK 100% CERTIFIED	BRANDED DISKS
3.5" DSDD 36p each	3.5" DSDD 44p each
3.5" Rainbow 44p each	Please phone for bulk purchase discounts
3.5" DSHD 50p each	
5.25" DS/DD 22p each	

STORAGE BOXES

10 capacity£0.95
NEW! 20 capacity Sony.....£1.49
50 capacity lockable£3.95
100 capacity lockable£4.50

80 cap Banx stackable/lockable ..£7.99
150 cap Posso stackable/lockable ..£15.00
250 cap stackable/lockable£18.99

Orders by phone or post to:

LOOK! LOOK! LOOK!

Tractor feed disk labels
500 plain white labels +
software to print your own
professional labels
only £9.95

JOYSTICKS

Quickshot II£6.50
Speedking Autofire£10.50
Competition Pro 5000 black.....£11.90
Competition Pro Glo Autofire.....£12.95
NEW! Competition Pro
Star Autofire£13.25
Maverick Autofire.....£12.95
Zipstick Autofire.....£12.95

MISCELLANEOUS

Mousehouse.....£1.60
Mouse mat£2.40
Disk drive cleaner.....£1.80
Amiga dust cover£3.50
Monitor dust cover.....£3.50
Mouse/joystick autoshift.....£14.95
Amiga lightpen + software.....£32.00
Mega mouse£14.90
Sqik mouse£14.90
Naksha mouse + access.....£22.00
Zy Fi amplifier + speakers.....£37.95
Thumb + finger trackerball£19.99
Crystal trackerball£32.00
Action Replay Mark III.....£57.00
Technosound Turbo sampler.....£30.00
2 piece printer stand.....£5.70
Midi Master.....£26.00
Wordworth 1.1£77.50

Telephone:

DIRECT COMPUTER SUPPLIES

54 Spring Road, Longton,
S-O-T, Staffs ST3 2PX

(0782) 642497 9.00am-5.30pm week

(0630) 653193 anytime

(0782) 311471 evening/weekend

AMIGA REPAIRS

FIXED CHARGE ONLY £42.99 Incl.

FIXED CHARGE INCLUDES PARTS, LABOUR, DELIVERY, VAT
90 DAY WARRANTY ON ALL REPAIRS
24 HOUR TURN-ROUND ON 95% OF REPAIRS
ALL UPGRADES PURCHASED FROM US FITTED FREE WITH REPAIR
REPAIRS ON DRIVES & KEYBOARDS, IF BEYOND REPAIR ADD £20.00
FULL DIAGNOSTIC TEST AND SERVICE

Est.
11 Years

SPECIAL OFFERS

Internal drive	46.99	68000 CPU	16.00
Fatter Agnus 8372A	42.95	CIAs	11.77
Kickstart 1.3 Rom	29.95	Keyboards	43.00
Kickstart 2.04 Rom	44.95	ROM Sharer	23.50
Gary IC	17.00	Mouse	15.95
Paula IC	29.00	Super Denise	32.50

VISA

ACCESS

⚠ ATTENTION ALL DEALERS ⚠

Our company now offer the most competitive dealer repair service
Full credit facilities available
Send for our Free information pack today

We reserve the right to refuse repair for whatever reasons
Prices only valid with this coupon

Service HOTLINE (0533) 470059

DART

DART Computer Services
105 London Road
Leicester LE2 0PF

Computer Services

AMIGA FORMAT

213

JUNE 1992

you it's not really their fault if some software doesn't run - the programmers have not followed Commodore's developer's guidelines. But at the end of the day, if anyone is going to take responsibility for the problem, they've got to do it.

Commodore do not provide a direct customer support service. They do have a Technical Support department, but Amiga owners are supposed to, in the first instance, go to their dealers.

So do so. If you're worried about software not working - especially if you're considering buying a ROM sharer, the fitting of which will invalidate your warranty - go to your Amiga dealer and ask him for full details of what software will and will not run. If you're not happy, ask more questions.

If it's still not clear, write to Commodore UK at Commodore House, The Switchback, Gardner Road, Maidenhead asking them to supply you with full information. Please write to us and tell us how you get on.

DODGY DISKS

Is it legal for people to sell Coverdisks? I attended my local car boot sale and was shocked to see one trader with a box full of them. There were easily a couple of hundred there, all with labels.

A Shawe, Wales

No, it is definitely not legal for anyone to resell Coverdisks and we would be immensely grateful if anyone who sees any on sale anywhere could write to us with details.

The complete story is complicated and a little bit annoying. Basically, it goes like this. We sell **Amiga Format** to the newstrade, who sell it on via wholesalers to the shops. Shops can order as many copies as they want, but they only pay the wholesale price for copies they sell. Any they do not sell they simply rip off the cover to prove it hasn't shifted and send that back to the wholesaler, and they are not charged for them.

Essentially, this means that unsold copies are just thrown away. Fortunately, there are very few unsold copies of **Amiga Format**. Even in the bin, however, they are our property, and this goes for the disks too.

This is a sad waste of good disks, but it's unavoidable at present. We've had people asking if they can recover them for charity, but unfortunately there is currently no legal way of doing this. The upshot, anyway, is that if you buy our disks without the magazine you are in receipt of stolen goods. Obviously we'd not hold it against you personally: but we would like to know if this sort of thing is going on, mainly so that we can make the case for having disks returned to us.

REQUEST

At the moment I am doing a computer studies course and part of the course includes data processing and word processing. The programs I am using for these two subjects are *dBase III plus* and *Wordstar 2000 Plus*. I would like to know if there are any similar programs for the Amiga.

Thomas Ryan, Upper Clapton

If I said those are a database and a word processor you should get the message that there's lots of similar programs for the Amiga. We'd recommend *Superbase Personal 2 (Precision/Oxxi-Aegis)* and *Protext (Arnor)* in those categories in your circumstances.

Better still, I think I'm right in saying - and you should check this with your supplier, because I could be wrong - that *Superbase* will load and save in *dBase* format, allowing you to transfer data between the programs on the PC and the Amiga. The same goes for the

word processors, which both use the common ASCII file format. Get a program called *CrossDOS* to let your Amiga read PC disks, and you're away!

ON A MISSION

I'm writing to see if you would let your readers know about the *Missionary* disk from ABOTS. If anyone is trying to learn to code 68000 and having trouble following the numerous books on the subject, then this is the disk for them. Much better than other coding tutorials I've seen. Perhaps you could review it?

Ken Hayes, Rotherham

I must admit I've never even heard of this disk, but it sounds like a good thing. Are you sure you didn't have anything to do with its creation, Ken? If anyone who does have a hand in its production or distribution could send us a copy, we'll certainly take a look at it.

IS THIS ALLOWED?

I am not exactly sure what is legal after seeing *SoundTracker* modules ripped from *Supercars 2* and *SWIV* on Public Domain disks. I have also seen a picture nicked from *Lemmings* on one.

A few of my mates seem to think that if the songs were made using *SoundTracker* or *Noisetraacker* they are PD and may be used in demos. As I make demos with my pal I want to know what is legal. Do I need the publishers' permission?

Chris Davis, Lightning!, Gloucester

To be honest, the copyright laws are stomped all over in the Public Domain, but as nobody seems to be completely aware of what the situation is we seem to see a rule of common sense which can do no real harm.

Legally, anything which has been created by someone is their 'intellectual property' and must not be reproduced in any form, electronic or otherwise. It's as simple as that.

Clearly, if this law were to be enforced to the hilt it would have a dramatic effect on PD all round: sampled sounds and digitised pictures would all have to be cleared for use. Even names, such as *Star Trek*, should not be used without permission.

It seems very likely that the PD scene is going to begin suffering from a clamp-down on copyright: we've already heard of disks being seized by the police for assessment.

However, I do not believe it could be argued that these intellectual properties are generally being abused for commercial gain and, as with the use of sound sampling on chart records, there is a legal grey area. A clamp-down could only result in stifled creativity, which would be a shame.

But there are definite cases which seem to be going

a step too far, and particularly those where another computer copyright is being abused. You should avoid using sounds or graphics from other computer programs without the publishers' written consent.

Incidentally, the whole confusion of PD is exemplified by the music program *SoundTracker* itself, which was never officially made freely distributable and yet is widely copied and distributed all the same.

PIRACY - THE LAST WORD?

I make no secret of the fact that I freely copy Amiga games and I am the proud owner of software and hardware which allows me to copy any game. I feel it's unfair to call people like myself 'pirates'.

To 'illegally' copy a game is not ignorant - it is common-sense. I have owned my dear Amiga for just over a year now, and during that time I have bought eleven games, only one of which is any good: *Kick Off 2*. Since then I have discovered that I could have got all those games 'pirated'. That is £250 down the drain.

I can't afford to waste that sort of money, and I'm sure most of your readers can't either. All software is ridiculously overpriced and it is ludicrous for software houses to expect the customer to dish out £25 for a couple of disks and a large snazzy box.

However, if these companies were to lower their prices to the £10-£15 range, I could be tempted to bin my copying gear and start enjoying myself. I would far rather own an original disk than a 'pirated' one.

Simon

This letter is pretty typical of many we have had over the last couple of months since we started in again on the ever-popular subject of copying games, and I think it represents accurately a very honestly-held opinion.

Many similar letters have come from people who admit they do copy games, and also many from people who say they don't, because they like to stay legal. But all share the same essential point of view: that they would far rather own a boxed original with the complete manual, and that a price of £10 or slightly above would make this possible.

It's also clear that copy protection does not really make a great deal of difference. For better or for worse, copying devices and software of all kinds are available, and such deterrents as manual protection or codewheels don't seem to make the grade in these days of the readily-accessible photocopier.

I think the evidence is now in favour of a lower price point realistically bringing in higher sales: I also think that the buyers of computer games have been 'educated' by these debates in **Amiga Format** to see £10 or so as reasonable and fair, which they would be willing to pay. But will it ever happen?

Spot the shot 35



Simply identify the game that this small portion of a screenshot is from, write the answer on a postcard with your name and address and send it in to us.

The address is Spot the Shot 35, **Amiga Format**, 30 Monmouth St, Bath BA1 2BW. The first correct entry out of the hat every month will win an **Amiga Format** T-shirt!



The winner of the Spot the Shot competition from Issue 33 is Daniel Upfield of Guildford in Surrey, who correctly identified this small portion of the picture from *the Return of Medusa*. An **Amiga Format** T-shirt is on the way to you!

GT BRITAIN SCENERY COLLECTION

for Flight Simulator 2 (Amiga & ST)

Great Britain Collection is a three disk set which provides a whole new environment in which to fly and explore. This set covers the whole of the U.K. and the Republic of Ireland in unprecedented detail with over 160 public access airports, many with VASI landing light systems and single and multiple I.L.S. approaches. This collection contains hundreds of navigation aids and includes special 3 colour charts.

Great Value at only £35.00 inclusive (FS2 only £29.95 inc.)

Pedal Patches. Allows the use of Quick-Joy Pedals with FS2 and FA18 Interceptor. **Special Price £4.95 each**

A320 Night Approaches. This essential add-on for A320 Airbus adds a whole new dimension and challenge to this impressive simulation.

£14.95 (A320 Airbus only £34.95 inc.)

GOLD AWARD

The Gravis MouseStick®

Better than the BEST Analogue Stick

GOLD AWARD

For sophisticated simulation enthusiasts, who demand PERFECT control, with programs such as Proflight, F19, Mig29, etc. A professional quality, programmable optical joystick C/W 16k microprocessor and L.C.D. screen offering 1200 line count resolution. Works perfectly with all simulations with sensible mouse routines and any others in its programmable joystick mode. No other joystick comes even close to the Mouse Stick for performance, reliability and pleasure in use. **£69.00 + p&p**



Full technical support and 1 year guarantee.
S.A.E. or telephone for full details
Telephone: (0272) 550900
Fax: (0272) 411052

R. C. Simulations
Unit 1b Beehive Trading Estate
Crews Hole Road
St. George
Bristol BS5 8AY.

★ **SPECIAL PRICE £99.00 per SET**
RING US ABOUT AIRBUS

Access Switchable voice/fax line **0983 551496** Open 10am-7pm Monday to Saturday

ACCOUNTS	Pro Clips Str. Art. 23.97	Office By Gold Disk 69.56	Directory Manager 19.74
Arena Integrated Ac. 99.64	Pro Page 3.7 2Mb. 159.80	The Works Platinum 39.95	Directory Opus 35.72
Cashbook Combination 54.99	Saxon Publisher 2Mb. 199.75	MULTIMEDIA	Disk Master 2 49.82
Cashbook Controller 37.60	DUST COVERS 15 lines stocked	AmigaVision (CBM) 39.95	Doctor Ami 40.89
EasyLedgers 153.46	Monitors 14" 9.87	Hyperbook 49.82	Facc 2 Disk Cache 23.97
Home Accounts Bundle 19.74	Amiga 500 7.99	PROGRAMMING	GB Route Plus 59.69
Home Accounts 2 39.95	EDUCATION	AMOS Compiler 24.91	Mavis Beacon Typing 27.73
Personal Finance Mgr 25.85	Maths Adventure 24.91	AMOS Creator 34.78	Personal Fonts Maker 49.82
System 3 Integrated 39.95	Mega Maths A Level 24.44	ARexx 33.84	Quarterback 39.95
BOOKS 40 Lines Stocked	Micro English (GCSE) 23.97	C PD (5 disks) 9.87	Quarterback Tools 59.69
Assembly Lang Prgmg 14.95	Micro French (GCSE) 23.97	Devpac 2 Assembler 39.95	Secretary 34.78
Amiga C Beginners 18.45	Micro Maths (GCSE) 23.97	Devpac 3 Assembler 54.99	Touch Typist 16.45
Amiga For Beginners 15.95	Money Matters UK <6 19.74	GFA Basic Compiler 23.97	TurboPrint Pro 44.65
AmigaDOS 2 Companion 23.45	Picture Book <6 19.74	GFA Basic Interp 29.61	Your Family Tree 2 66.27
AmigaDOS Inside/Out 18.45	Primary Maths 24.44	HighSpeed Pascal 79.90	VIDEO
CBM AmigaDOS Manual 21.95	EDITORS	Lattice C 5.1 159.80	Compugraphic Fonts 64.86
CBM Hardware Ref Mnl 21.95	CygnusEd Pro 2 59.69	Power Windows 59.69	Digi View Gold 4 109.98
CBM ROM K7 Devices 29.95	Turbo Text 59.69	RIBBONS	Hitachi Camera/Lens 204.45
CBM ROM K7 Incs & Docs 29.95	GRAPHICS	6 CBM MPS1230 28.20	Rendale 8802 Genlock 189.88
CBM Service Mnl A500 14.95	Animation Studio 79.90	6 CBM MPS1500 33.84	RocGen Genlock 99.64
CBM Schem. A2000/6 14.95	Art Department Pro 2 149.93	3 CBM MPS1500 Colour 36.66	Scala 500 79.90
CBM 500/2000 Tec Ref 44.95	DC TV Colour System 479.87	6 Citizen 1200 19.74	ShowMaker 179.54
Kids And The Amiga 14.95	Deluxe Photolab 56.40	SOUND	Take 2 Animation 79.90
Imagine Companion 24.95	Deluxe Paint 3 Bundle 29.61	Audiomaster 4 s/w 49.82	TV Text/Show 39.95
Using ARexx on Amiga 29.95	Deluxe Paint 4 64.86	Bars & Pipes Pro 219.96	Video Director 129.72
CABLES 100 Lines Stocked	Imagine 2 X 209.62	Deluxe Music 54.99	Vid Complete Solution 159.80
D23S-D15S NEC MS 3D 14.10	Pixel 3D 2 69.56	GVP Sound Studio 59.69	VIDEO TAPES New line
D23S/2Ph-Scart Mon 11.75	Pixmate 39.95	MIDI Plug Interface 25.38	Animation 1 15.98
D25P-D25P 25W 2M 13.18	Real 3D Turbo 2Mb 329.94	Music X Junior 66.27	Desktop Video 1 15.98
D25P-C36P 2M Printer 6.58	Real 3D 1.3 119.85	Sequencer One 74.73	WORDPROCESSORS
D25P-D25P 9W 2M Mod. 11.28	Scene Maker 39.95	Softx 2 49.82	Excellence 2 69.56
DIN5P-DIN5P MIDI 5.17	Scene Generator 34.78	Sound Trap 3 Sampler 30.55	Final Copy WP/DTP 79.90
Amiga To Mac 12.69	Scenery Animator 69.56	SoundMaster Sampler 109.98	PenPal 59.69
Null Modem Cable 2M 11.75	Sharp Colour Scanner 599.72	Stereo Master Sampler 34.78	Personal Write 29.61
Null Modem Cable 5M 15.98	Vista Pro 3Mb 79.90	SuperJAMI Composer 84.60	Proper Grammar 59.69
Gander Changers each 7.99	HARDWARE	Zero-G 72 Samples 29.61	Protex 4.3 44.65
Socket D23S & Hood 5.17	3.5" External Drive 58.75	SPREADSHEETS	Protex 5.5 101.99
Switch Box D25S x 2 19.74	3.5" Int A2000 Drive 58.75	Advantage 69.56	ProWrite 3.7 99.64
COMMUNICATIONS	512K A500 RAM/Clock 29.61	Professional Calc 139.59	QuickWrite 39.95
Comms PD (2 Disks) 4.70	1Mb A500P RAM 49.82	Superplan 49.82	Scribble Platinum 42.77
COMPUTER AIDED DESIGN	Amiga 1500 no s/w 519.82	UTILITIES	TransWrite 32.90
Design Works 69.56	Amiga 1500 s/w 579.98	Ami-Back SCSI Backup 49.82	Wordworth 67.89
IntroCAD Plus 89.77	Amiga Ref 2 & ROM 84.60	B.A.D. Optimiser 34.78	
Professional Draw 2 89.77	Chip Agnus 1Mb 59.69	BBC Emulator 35.72	
Professional Draw 3 199.75	Chip ECS Denise 39.95	Byte 'N' Back 19.74	
ProVector 2.7 199.75	Chip ECS Kickstart 2 44.65	CrossDOS Transfer 24.91	
DATABASE MANAGERS	Chip Kickstart 1.3 29.61		
Bible Reader NIV 59.69	Datalyzer A500 SCSI 129.72		
HomeBase 29.61	GVP A2000 030EC/25 559.77		
Image Finder 49.82	GVP A2000 2-8Mb RAM 169.67		
InfoFile 46.06	GVP A2000 SCSI 0-8Mb 139.59		
Mailshot Plus 39.01	GVP A2000 520-8Mb 279.65		
Prodata 1.2x 69.56	GVP A2000 1200-8Mb 409.84		
Superbase Personal 2 34.78	GVP A500 520-8Mb 359.55		
Superbase Pro 4 169.67	GVP A500 1050-8Mb 489.53		
DESKTOP PUBLISHING	GVP A500 2400-8Mb 729.91		
AmigaTeX Typesetting 111.39	GVP A530/52 68030EC 689.96		
AmigaTeX Drivers (1) 52.64	Naksha Mouse & Game 29.61		
GDType Sets (each) 32.90	ROM Share Board 23.97		
Outline Fonts 99.64	INTEGRATED PACKAGES		
PageSetter 2 45.59	Appelizer 30.55		
Pagestream 2.2 169.67	Graphics Starter Kit 56.40		

Richard & Angela Howe: Applied Research Kernel
Dept AFM, Corve Farmhouse, Corve Lane,
Chale Green, Nr. Ventnor, PO38 2LA, U.K.
POST & PACKING (on items averaging less than 1Kg):
U.K. £0. Special Delivery £3.29, Securitor £9.87.
BFPO & CHANNEL ISLANDS £0, Special Delivery £3.29.
EUROPE £5 1st item + £3 for each additional item.
WORLD £15 1st item + £9 for each additional item.
CHEQUES London Sterling to A.R.K. Cheques may clear.
NORMAL DESPATCH Stock 24 hrs. Supplier 48 hrs.
EXPORT & BFPO Remove UK VAT (£1.175) (Not Books)
V.A.T. Prices include V.A.T. Books are zero rated.
PRICES Are necessarily subject to change.
MEMORY Assume 1Mb RAM to load, unless stated.
Visitors are always welcome by appointment

AMIGA REPAIRS

Repairs from £23.00 inclusive.
Free registered carrier pickup and return despatch for ultimate peace of mind, anywhere in the UK mainland!
Free diagnostic inspection.
All repairs carried out are covered by free 90 day warranty.
Fast efficient service, average diagnostic and repair time - 24 hours!
Experienced, qualified engineers.
Any upgrade fitting, fixed price £15.00 inclusive.
Terms and conditions available on request.



Business Enterprise Centre, Eldon Street,
South Shields, Tyne & Wear, NE33 5JE.
Telephone: 091-455 4300

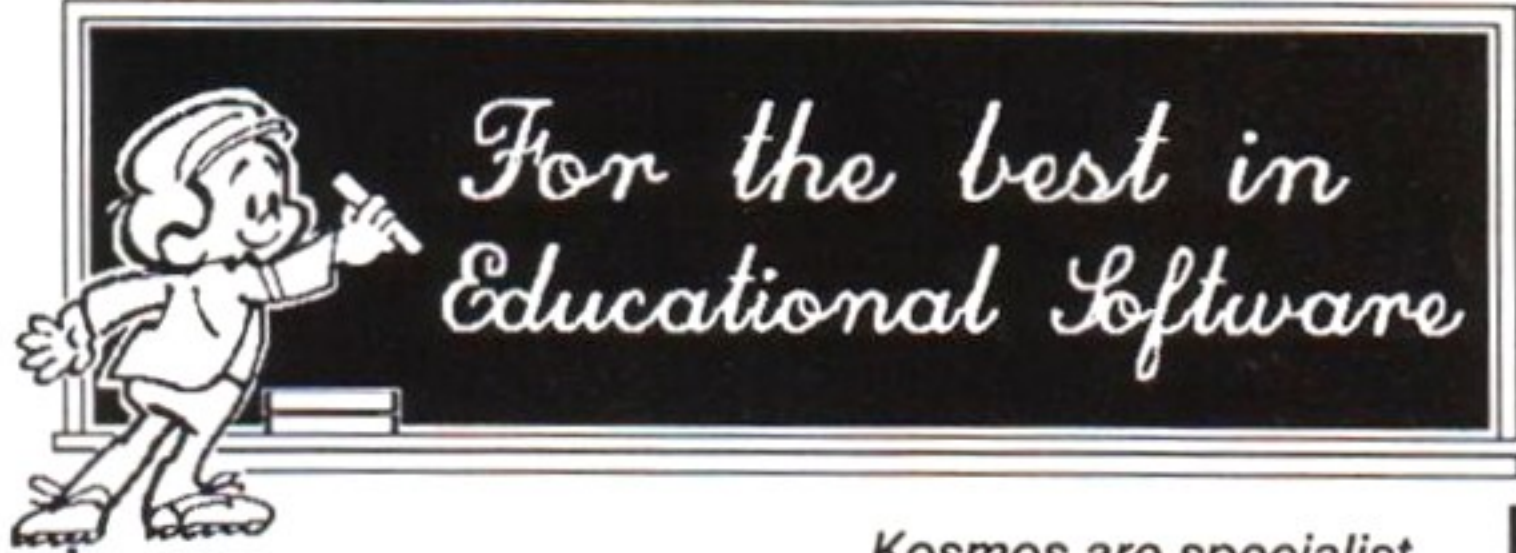

- SUBJECTS**
- French, Spanish
 - German, Italian
 - Science, History
 - Geography
 - English Words
 - Spelling
 - Arithmetic
 - Football, Sport
 - First Aid
 - General Knowledge
 - England, Scotland
 - Natural History

Kosmos are specialist producers of Educational Software designed to help you enjoy learning from your computer. Versions are available for most popular home & business computers. Many of our programs even allow you to add your own lesson material.

Write or telephone for our **NEW FREE 16-page COLOUR BROCHURE** of Educational & Leisure software

NEW RELEASE "AMIGA MATHS ADVENTURE" £25.99

Kosmos Software Ltd, FREEPOST (no stamp needed in UK)
DUNSTABLE, Beds. LU5 6BR
Telephone 0525 873942 or 875406

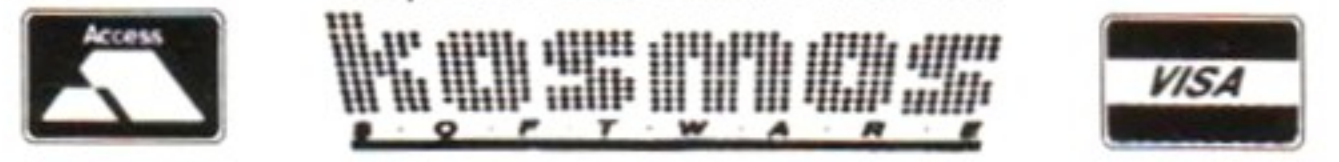

AMIGA FORMAT

JUNE 1992

215

PREMIER MAIL ORDER

Titles marked * are not yet available and will be sent on day of release.

Please send cheque/PO/Access/Visa No. and expiry date to:

Dept AF6, Trybridge Ltd., 8 Buckwins Sq., Burnt Mills, Basildon, Essex. SS13 1BJ

Please state make and model of computer when ordering. P&P inc. UK on orders over £5.00. Less than £5.00 and Europe add £1.00 per item. Elsewhere please add £2.00 per item for Airmail. These offers are available Mail Order only.

Telephone orders: Mon-Fri 9am-7pm. Saturday 10am-4pm. Fax orders: 0268 590076. Tel orders: 0268 590766

2 Hot 2 Handle	18.99	G LOC *	16.99	R-Type	6.99
3D Construction Kit	32.99	Godfather Action	19.99	Race Drivin	16.99
3D Pool	7.99	Godfather Adventure	19.99	Railroad Tycoon (1 Meg)	22.99
4D Boxing (1 Meg)	16.99	Gods	16.99	Rainbow Collection	13.99
4D Driving (1 Meg)	19.99	Golden Axe	16.99	Rainbow Islands	6.99
4 Wheel Drive *	19.99	Graham Gooch *	19.99	Rambo 3	6.99
Abandoned Places	19.99	Gunship 2000 * (1 Meg)	22.99	R.B.I. 2 Baseball	19.99
Addams Family *	18.99	Gun Spy *	26.99	Reach for the Skies *	22.99
Afterburner	6.99	Hard Drivin	6.99	Realms (1 Meg)	19.99
Agony	24.99	Harlequin	16.99	Red Baron (1 Meg)	22.99
Airbus	22.99	Harpoon	19.99	Red Heat	6.99
Air, Land, Sea	24.99	Harpoon Battleset 3	9.99	Renegade	6.99
Air Support *	19.99	Harpoon Battleset 4	9.99	Rick Dangerous	6.99
Altered Beast	6.99	Harpoon Scenario Editor	13.99	Rise of the Dragon (1 Meg)	22.99
Amos	29.99	Head Over Heels	6.99	Robin Hood	16.99
Amos 3D	24.99	Heart Of China (1 Meg)	22.99	Robin Smith Cricket	16.99
Amos Compiler	19.99	Heimdall (1 Meg)	19.99	Robocod	16.99
Another World	19.99	Hitchhikers Guide	7.99	Robocop	8.99
APB	6.99	Hook *	19.99	Robocop 3	16.99
Arkanoid 2	6.99	Hudson Hawk	16.99	Rock Star Ate My Hamster	4.99
Award Winners *	16.99	Hunter	19.99	Rodland	16.99
Assault on Alcatraz *	16.99	IK+	6.99	R-Type 2	16.99
Bards Tale Triple Pack *	24.99	Indy Heat	16.99	Ruff and Ready	6.99
Batman Caped Crusader	6.99	Indy Jones - Atlantis Action *	19.99	Rugby World Cup	16.99
Batman the Movie	6.99	Indy Jones - Atlantis Adv * (1 Meg)	19.99	Rules of Engagement	16.99
Battle Chess 2	16.99	Ivanhoe	6.99	Run the Gauntlet	6.99
Beastbusters	9.99	Jack Nicklaus Clip Art	9.99	Search for the King	24.99
Beach Volley	6.99	Jack Nicklaus Extra Courses	9.99	Secret of Monkey Island (1 Meg)	16.99
Big Run	16.99	Jack Nicklaus Golf	12.99	Secret Monkey Island 2 (1 Meg) *	19.99
Billy the Kid *	16.99	Jack Nicklaus Unlimited Golf (1 Meg)	19.99	Secrets of Luftwaffe * (1 Meg)	19.99
Birds of Prey (1 Meg)	22.99	Jimmy Whites Snooker	19.99	Shadow Lands	19.99
Black Crypt	19.99	John Madden	19.99	Shadow Sorcerer (1 Meg)	19.99
Blues Brothers	16.99	Keys of Maramon *	16.99	Shadow Warriors	6.99
Blue Max	19.99	Kick Off	7.99	Shinobi	8.99
Board Genius	19.99	Kick Off 2 (1 Meg)	11.99	Shoot Em Up Con Kit	8.99
Bonanza Bros *	16.99	Kick Off 2	9.99	Shuttle *	34.99
Bubble Bobble	6.99	Kings Quest 5 (1 Meg)	22.99	Silent Service 2 (1 Meg)	22.99
Budokan	8.99	Klaxx	6.99	Silkworm	8.99
Cabal	6.99	Knightmare	19.99	Sim Ant *	19.99
California Games	6.99	Knights of the Sky (1 Meg)	22.99	Sim City+Populous	19.99
Campaign *	22.99	K.O 2 - Final Whistle	8.99	Sim Earth *	19.99
Capcom Collection	19.99	K.O 2 - Giants of Europe *	7.99	Simpsons	16.99
Castles	19.99	K.O 2 - Return to Europe	7.99	Ski or Die	8.99
Centurion	8.99	K.O 2 - Super League *	9.99	Smash TV	16.99
Chaos Engine *	16.99	K.O 2 - Winning Tactics	5.99	Space 1889 (1 Meg)	19.99
Chaos Strikes Back (1 Meg)	16.99	Laser Squad 2	16.99	Space Ace	26.99
Chart Attack 1	19.99	Last Ninja 2	6.99	Space Ace 2	26.99
Chase HQ	6.99	Last Ninja 3	16.99	Space Crusade	16.99
Civilisation * (1 Meg)	22.99	Leander	16.99	Space Gun	16.99
Conan The Cimmerian *	19.99	Leather Goddess	7.99	Special Forces *	22.99
Continental Circus	8.99	Legend *	16.99	Starflight 2	16.99
Covert Action * (1 Meg)	22.99	Leisure Suit Larry 5 (1 Meg)	22.99	Strider	6.99
Crazy Cars 3 *	16.99	Lemmings	16.99	Strikefleet	16.99
Cricket (1 Meg)	9.99	Lemmings Construction Kit *	16.99	Strip Poker 2 + Data	6.99
Cruise For A Corpse	19.99	Lemmings Data Disk	13.99	Stunt Car Racer	6.99
Cyberball	6.99	Licence To Kill	6.99	Super Hang On	6.99
Daley Thompson Challenge	6.99	Lombard Rally	6.99	Super Sega	19.99
Das Boot	19.99	Lord of the Rings	19.99	Suspicious Cargo	19.99
Deathbringer	19.99	M1 Tank Platoon	19.99	Switchblade	6.99
Death Knights Of Krynn (1 Meg)	19.99	Magic Fly	8.99	Switchblade 2	16.99
Deluxe Paint 4	54.99	Magic Pockets	16.99	Team Jaguar *	19.99
Demonsgate *	22.99	Magnetic Scrolls Coll (1 Meg)	19.99	Team Suzuki	16.99
Deuterios	19.99	Man Utd. Europe	16.99	Team Yankee	19.99
Disney Animation	59.99	Mega Traveller 1 (1 Meg)	19.99	Team Yankee 2 (1 Meg) *	19.99
Dizzy Collection	16.99	Mega Traveller 2 (1 Meg) *	19.99	Teenage Mutant Turtles 2 *	16.99
Double Double Bill	24.99	Mega Twins	16.99	Terminator 2	16.99
Double Dragon	8.99	Miami Chase	6.99	Test Drive 2 Collection	19.99
Double Dragon 2	8.99	Microprose Golf	22.99	The Immortal (1 Meg)	8.99
Double Dragon 3	16.99	Midnight Resistance	6.99	Their Finest Hour (1 Meg)	19.99
Dragon Ninja	6.99	Midwinter	14.99	Their Finest Missions	9.99
Dragons Lair (1 Meg)	26.99	Midwinter 2 (1 Meg)	22.99	Thunderhawk	19.99
Dragons Lair 2 - Singes Castle	26.99	Mig 29 Super Fulcrum	26.99	Tip Off	16.99
Dragons Lair - Time Warp	26.99	Might & Magic 3 *	19.99	Titus The Fox *	16.99
Elf	16.99	Moonstone (1 Meg)	19.99	TNT 2 *	19.99
Elvira 2 (1 Meg)	24.99	New Zealand Story	6.99	Toki	16.99
Epic *	19.99	Ninja Collection	13.99	Toobin	6.99
Eye of the Beholder (1 Meg)	19.99	Operation Thunderbolt	6.99	Top Cat Bev. Hills	6.99
Eye Of The Beholder 2 (1 Meg) *	19.99	Operation Wolf	6.99	Turbo Challenge 2	16.99
Eye of the Storm *	19.99	Ork *	19.99	Turbo Outrun	6.99
F15 Strike Eagle 2 (1 Meg)	22.99	Outrun	6.99	Turrican 2	9.99
F16 Combat Pilot	8.99	Outrun Europa	16.99	Ultima V	19.99
F19 Stealth Fighter	19.99	Paperboy 2	16.99	Ultima 6	19.99
Face Off *	16.99	Parasol Stars	16.99	Untouchables	6.99
Falcon 3 *	24.99	Pegasus	16.99	Utopia	19.99
Ferrari Formula 1	8.99	PGA Golf Courses	9.99	Utopia Data Disk *	9.99
Final Blow	16.99	PGA Tour Golf	16.99	UMS 2 (1 Meg)	19.99
Final Fight	16.99	Pitfighter	14.99	Voyager	6.99
First Samurai + Mega-Lo-Mania	19.99	Pinball Dreams	16.99	Warlords (1 Meg)	19.99
Flag *	19.99	Platoon	6.99	Wild Wheels	16.99
Flood	8.99	Player Manager	12.99	Wizball	6.99
Football Crazy	16.99	Pool of Radiance (1 Meg)	19.99	Wizkid *	16.99
Football Director 2 (1 Meg)	16.99	Pools of Darkness (1 Meg)	19.99	Wolf Child	16.99
Forgotten Worlds	6.99	Populous	8.99	Wolf Pack (1 Meg)	19.99
Formula One Grand Prix (1 Meg)	22.99	Populous 2 * (1 Meg)	19.99	Wonderland (1 Meg)	19.99
Fun School 4 under 5	16.99	Powerdrift	8.99	World Class Leaderboard	6.99
Fun School 4 5-7	16.99	Powermonger	19.99	World Cup Cricket (1 Meg)	19.99
Fun School 4 7-11	16.99	Powermonger Data Disk 1	9.99	World Wrestling Fed	16.99
Gauntlet 3	16.99	Predator	6.99	Xenomorph 2 *	16.99
Ghostbusters 2	6.99	Prince Of Pershia	6.99	Yogi's Great Escape	6.99
Ghouls and Ghosts	6.99	Projectyle	8.99	Yogi & Greed Monster	6.99
		Quest for Adventure	19.99		

SPECIAL OFFERS

**DELUXE PAINT 4
ONLY
£54.99**

**OPTICAL MOUSE
ONLY £34.99**

**UPGRADE YOUR
AMIGA TO 1 MEG**

1/2 Meg Upgrade - £24.99
1/2 Meg Upgrade + clock - £26.99

JACK NICKLAUS GOLF

ONLY
£12.99

STEREO SPEAKERS

**AMIGA
ONLY £29.99**

**3.5" EXTERNAL
DRIVE
ONLY £49.99**

JOYSTICKS

Quickjoy Topstar - £16.99
Comp Pro Extra - £14.99
Quickjoy 2 Turbo - £9.99
Quickshot 3 Turbo - £9.99
Quickjoy Jetfighter - £10.99

BLANK DISKS

Unbranded

10 x 3.5" DSDD - £5.99
20 x 3.5" DSDD - £10.99
50 x 3.5" DSDD - £23.99
100 x 3.5" DSDD - £44.99

Branded - TDK

3.5" DSDD - £1.25 Each

NAM

Now Only
£12.99



**A500 + Expansion Stand
Only £34.99
including VAT & delivery**

- ★ Trade enquiries Mrs Leigh L Sharif
- ★ Delivery 5 days
- ★ Colour coded to your Amiga
- ★ Fitted in seconds
- ★ Shelf for disk drives

LEADS £7.99 PER PAIR

**CREDIT CARD HOTLINE
0908 262137**



ORDER FORM

Name

Address

Postcode

Tel. No.

Cheques payable to:
AVA Developments Ltd
 58 Burners Lane South
 Kiln Farm
 Milton Keynes
 MK11 3HD
 (0908) 262137

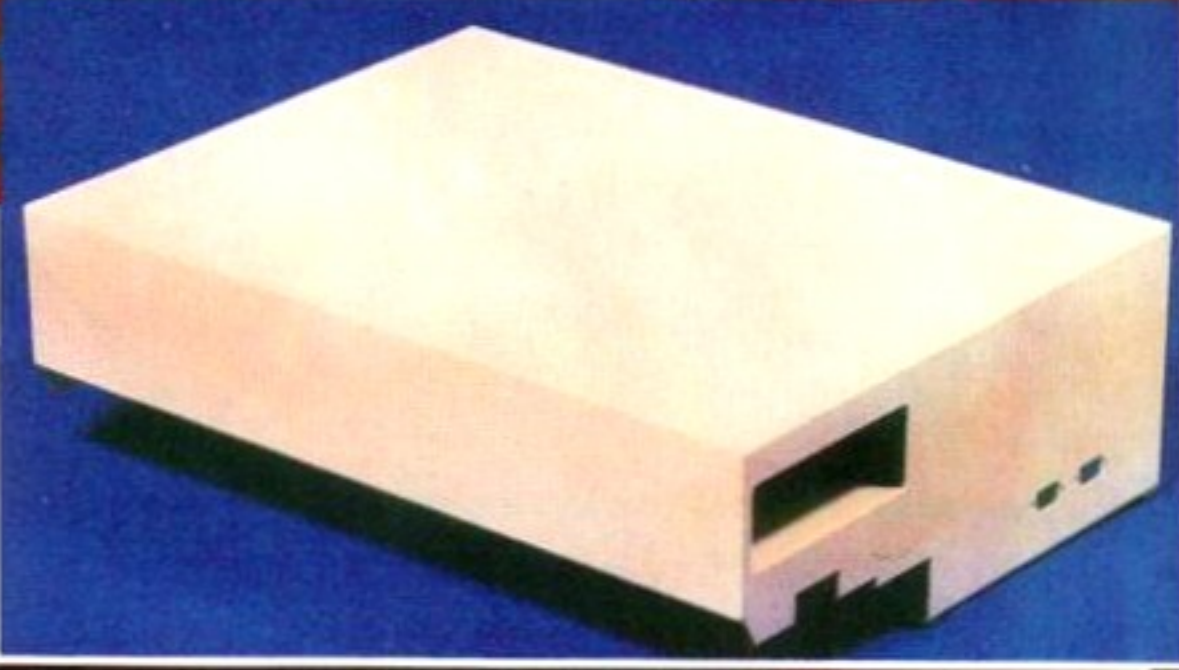

ADVERTISERS INDEX

1st Choice (Leeds) 119-121 (0532) 637988	Direct Computer Supplies 213 (0782) 642497	Phoenix 74 (0532) 311932
16 Bit Centre 132 (0423) 526322	DPA 21 Post Only	Poste Haste 140 (0227) 766788
17 Bit Software 168 (0924) 366982	Dynamite Computers 84-85 (0234) 218060	Power Computing Ltd
A.R.K. 215 (0983) 551403	Eagle Software 199 081-361 2733 39, 141, IBC (0234) 843388
ACS Electronics 215 091-455 4300	Electronic Arts 10, 15 (0753) 549442	Premier Mail Order 216 (0268) 590766
Amiga Power 65 (0225) 442244	Entertainments International 56 (0268) 541126	Prodisc PD 171 021-458 2404
Amiga Shopper 195 (0225) 442244	ESP Education 81 (0702) 600557	Protar Ltd 22 (0923) 254133
Amiganuts 158 Post Only	Europress Software Ltd 55 (0625) 859333	Public Domain 164 (0225) 442244
Analogic Computers 169 081-546 9575	Evesham Micros 72-73 (0386) 765500	Public Dominator 96 (0279) 757692
Anglia PD 169 (0394) 283494	Firecrest Distribution 133 (0873) 850028	Rage Software 46 051-707 2280
Ashcom 64 (0530) 411485	Five Star PD 171 (0827) 68496	RC Simulations 215 (0272) 550900
Audition Computer	FMG (Amiga Repairs) 100 (0733) 391234	Renegade 18, 29 071-481 9214
Services 24-25 (0780) 55888	Fun Factory Promotions Ltd 153 (0734) 817421	Sega Power 38 (0225) 442244
AVA Developments 217 (0908) 261600	Futureworld 124-125 (0234) 218060	Sidewise Ltd 171 (0225) 442244
Axe direct 99 081-446 5950	FX Direct 206 (0296) 682277	Silica Systems .. 71, 137, 155, 191 081-309 1111
Barkman 158 081-546 5941	Gasteiner 186 081-365 1151	Snap Computer Supplies Ltd . 133 (0703) 457111
BCS 60 (0273) 506269	Genisoft 180 (0753) 686000	Soft Swap 173 (0732) 845610
Beaugh's British Domain 158 (0532) 642550	Gremlin 63 (0742) 753423	Softstore 181 (0628) 668320
Best Prices 198 (0903) 700714	Harwoods 109-115, 209 (0773) 520252	Software City 188 (0902) 25304
Bitcon Devices 166 091-490 1919	Intracom 193 (0274) 626474	South Lincs PD 166 (0778) 393470
Calculus 143-149 (0543) 251275	K2 Software 170 (0734) 583063	Strategic Plus 213 081-977 8088
Castlesoft 133 (0333) 421243	K=11 158 081-657 1612	Switchsoft 169 (0325) 464423
Codemasters 49 (0926) 814132	Kosmos 215 (0525) 873942	Talking Birds 181 (0702) 523607
Commodore Business	Ladbroke Computing 210 (0772) 203166	Technomania 153 (0382) 22323
Centre 78 071-833 5609	Lazersoft 136 081-747 9308	Time and Space 187 (0442) 870681
Composer Software 187 (0600) 860706	LCL 193 (0491) 579345	Tom Petty Promotions 105 (0289) 331122
Computermates 82 (0753) 553535	Matrix Leisure 213 (0920) 444224	Total! 79 (0225) 442244
Connect International 170 (0296) 682277	MC PD 166 (0702) 351941	Trilogic 200-201 (0274) 69115
Cooleen Computer	MD Office Supplies 116 (0689) 861400	Turcan Research 105 071-625 8455
Services 173 (0247) 811091	Merlin Express 58-59 (0602) 441442	Ultimate PD 163 (0222) 522497
Cortex Limited 106 051-236 0480	Microdeal 40, 126 (0726) 68020	United PD Federation 160-161 (0983) 529594
Cottage Industries 173 (0639) 845605	Micromail 128-129 (0923) 894111	Virgo Developments 208 (0276) 676309
Dart Computer Services 213 (0533) 470059	Microprose 67 (0666) 504326	We Serve 82 (0705) 325354
Datagem Ltd 204 071-608 0624	Misdem Metal Box 213 (0785) 223438	Wishful Thinking 169 (0946) 841481
Dataplex 171 (0753) 535557	MJC Supplies 194 (0462) 481166	WTS Electronics 193, 205 (0582) 491949
Datel Electronics 89-93 (0782) 744707	Ocean Software	
Deltrax PD 171 (0492) 515981 IFC, 3, 77, 219, IBC 061-832 6633	
Diamond Computers 174-177 (0703) 232777	PD Direct 68 (0782) 711237	
Digit International 30 (0395) 270273	PD Soft 165 (0702) 566933	
Dimension Computers 44 (0533) 517479	Pentire PD 173 (0628) 666641	

NEXT MONTH

YOU and the Amiga

Who are you? Are you a typical Amiga user, or are you a bit of an eccentric? Do you play too many games, or would you rather spend your time doing something you think is a bit more useful? Do you have a plain and simple Amiga 500, or are you the owner of an Amiga 3000 with 16Mb or RAM?

To put it another way: **how normal are you?**

In next month's world-beating Amiga Format, find out what the average Amiga owner is like as we reveal the results of the biggest survey of Amiga owners ever conducted: our very own readers poll!

PLUS The Amiga Format Collection No. 4

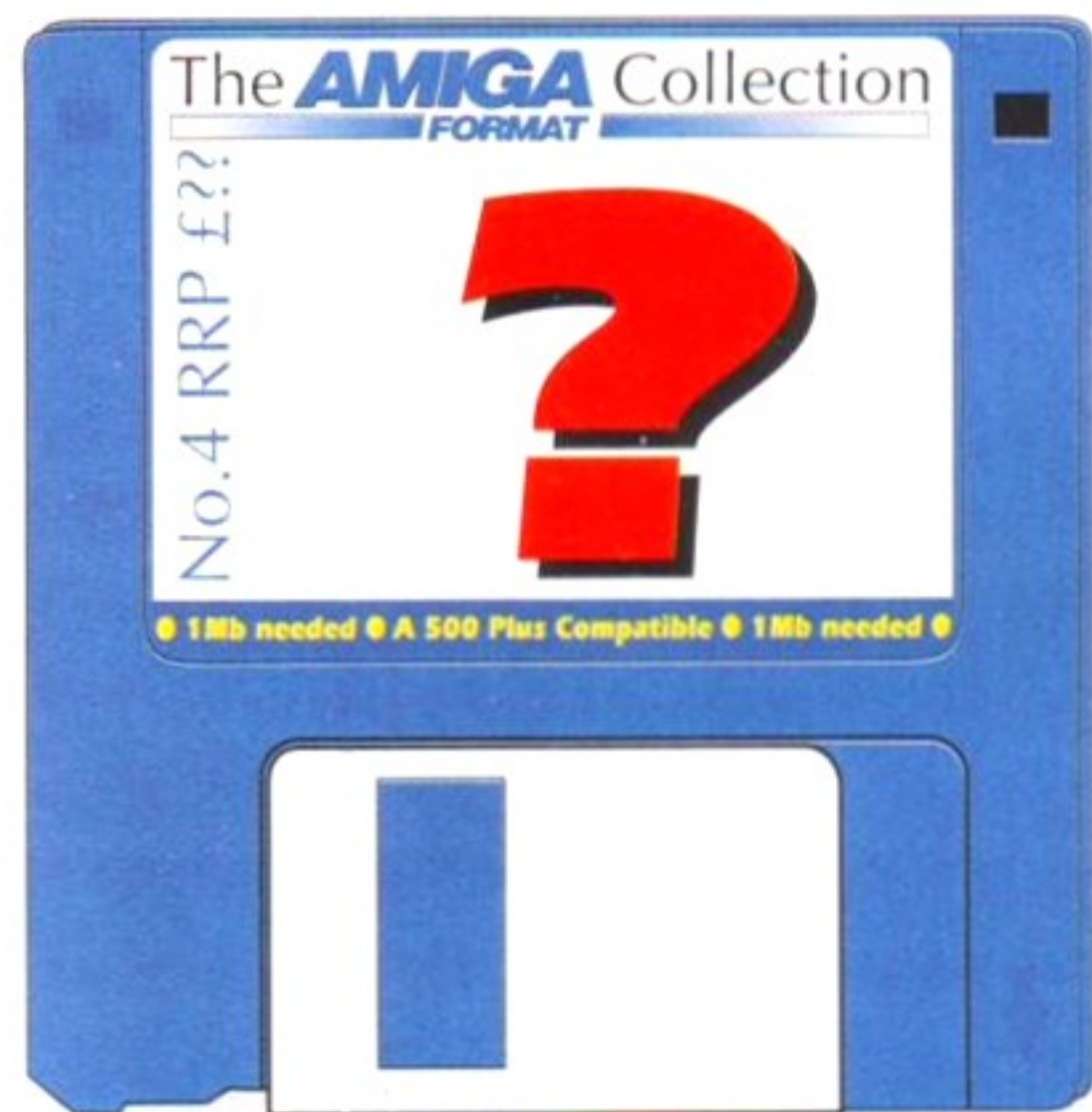

YES, once more **Amiga Format** will be bringing you two disks and a complete, top-class, full-price program, all for the remarkable price of £3.95!

Next month's complete program is Directory Opus* from American utility specialists Innovatronics, a fabulous and useful utility that gives you complete control over all the awkward and difficult-to-reach bits of the Amiga, without any of the sweat, toil and tears involved in the CLI.

It'll be going like hot cakes off a shovel, so get to the shops early!

* May be subject to change

Amiga Format

EDITOR Damien Noonan
ART EDITOR Marcus 'Dr' Dyson
GAME REVIEWS EDITOR Neil Jackson
TECHNICAL EDITOR Pat McDonald
PRODUCTION EDITOR Gary Lord
STAFF WRITER Maff Evans
FRANK'S JOB Lam Tang
EDITORIAL ASSISTANT Clare Hodgson
ABSENT CORRESPONDENT Asam Ahmad
CONTRIBUTORS James Leach, Neil West, Andy Hutchinson, Jon Pillar, Tim Smith, Brian Larkman, Eva Hoogh, Trenty Webb, Ed Ricketts, Chris Lloyd
GROUP ADVERTISING MANAGER Jonathan Bint
DEPUTY AD MANAGER Duncan Ferguson
GAMES MANAGER Cheryl Beesley
SENIOR SALES EXEC Tim Partridge
AD PRODUCTION Nicola Lucas
PUBLISHER Gregory Ingham
PROMOTIONS MANAGER Michele Harris
PROMOTIONS ASSISTANT Tamara Ward
PHOTOGRAPHY Ashton James, Bradford-on-Avon
COLOUR ORIGINATORS Phoenix Repro
PRINTERS Chase Web, St Ives PLC, Plymouth
NEWS TRADE DISTRIBUTION UK Future Publishing 0225 442244
NEWS TRADE DISTRIBUTION OVERSEAS: MMC Ltd 0483 211222
CIRCULATION DIRECTOR Sue Hartley 0225 442244



Home of Britain's finest magazine.

AMIGA FORMAT

Amiga Power • Amiga Shopper • ST Format
 Sega Power • Public Domain • Total
 Amstrad Action • Your Sinclair
 Commodore Format • PC Answers
 PC Format • PCW Plus • PC Plus
 Mountain Biking U.K. • Cycling Plus
 Needlecraft • Classic CD • Photo Plus

A FAREWELL TO FRANKIE...

So, farewell then, Frank Bartucca. Once the design of our games pages was so nice, but now... You've gone to drop out, tune on and turn in in the Land of the Free. And have we noticed the difference? No. You always were a cu- (Snip! - Ed).

AMIGA FORMAT

218

JUNE 1992

Dear Newsagent,

Please reserve me a copy of the next issue of **Amiga Format**:

Amiga Format Issue 36, July 1992 – on sale Thursday June 11

Name

Address.....

To the Newsagent: **Amiga Format** is published and distributed by Future Publishing and is available from your wholesaler. Send back these coupons for entry in a free prize draw to: Kate Elston, Future Publishing, 30 Monmouth Street, BATH BA1 2BW. Remember to include your shop, name and address.

Your guarantee of value

This magazine comes from Future Publishing, a company founded just seven years ago but now selling more computer magazines than any other publisher in Britain. We offer:

Better advice. Our titles are packed with tips, suggestions and explanatory features, written by the very best in the business.

Stronger reviews. We have a cast-iron policy of editorial independence and our reviews give clear buying recommendations.

Clearer design. You need solid information fast. So our crayon-wielders

highlight key elements by using charts, diagrams, summary boxes, annotated photographs, and so on...

Greater relevance. At Future, Editors operate under two golden rules:
 ● Understand your readers' needs.
 ● Er, satisfy them.

More reader interaction. We draw on readers' contributions, resulting in the liveliest letters pages and the best reader tips. Buying one of our magazines is like joining a nationwide user group.

Better value for money. More pages, better quality – magazines you can trust.

THIS GAME IS NO...



FEATURING
G.I. ANT™

**PUSH-OVER IS A
BRILLIANT NEW CONCEPT
IN ACTION-PUZZLE GAMES.**

You've never played anything like this before!
In Push-Over you will meet Colin Curly and a New Superstar, G.I. Ant, the most dynamic and instantly likeable character in video games. Solve a series of mind-expanding puzzles using super-power dominoes set in a series of stunningly designed themes. Push-over and G.I. Ant - together they add up to a winning combination!

**ATARI ST
CBM AMIGA
IBM PC &
COMPATIBLES**

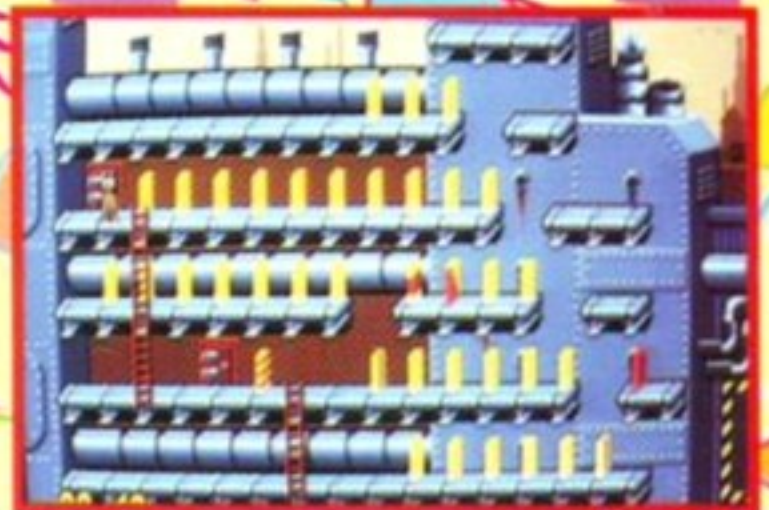
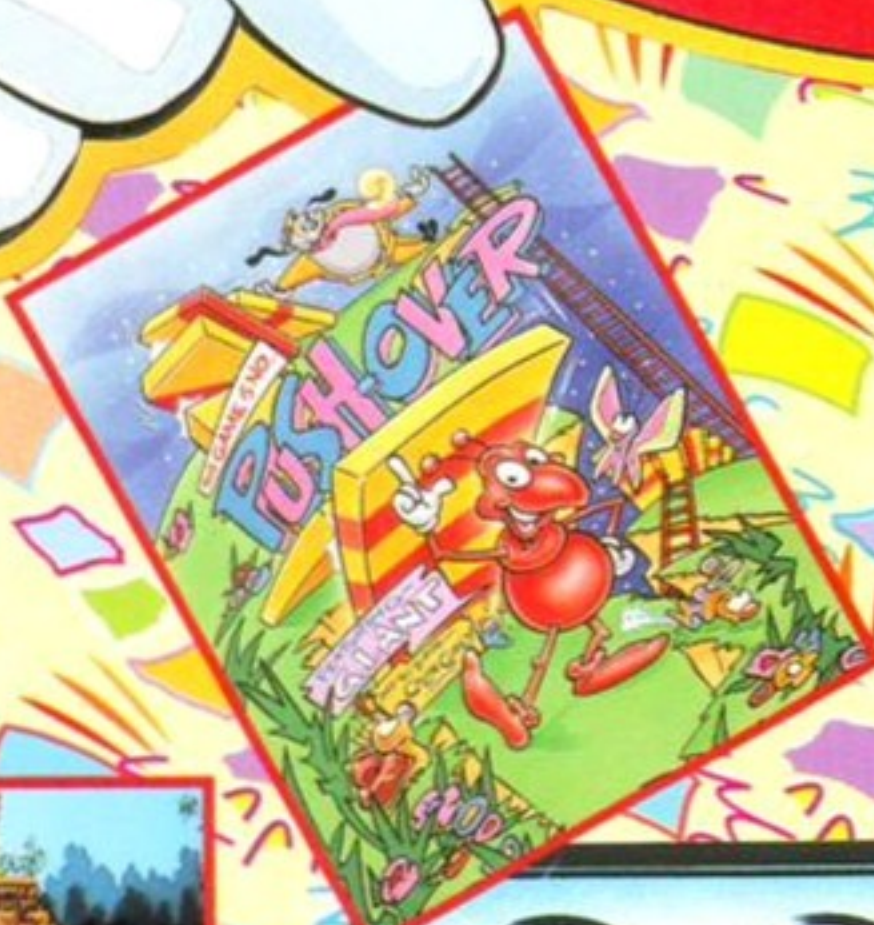

ACTION CARTRIDGE SUPER IV

The Freezer-Utility Cartridge

Action Cartridge Super IV **£55.00**

Thru'port adaptor **£19.95**

Upgrades when available in the next 12 months will cost £9.95
(No need to exchange your cartridge, and add extra expense)

1988 Copyright Laws Apply

Manufactured by PWH/GameWorks

Sole distributor



Power Computing Ltd Unit 8 Railton Road
Woburn Road Ind. Estate Kempston Bedford MK42 7PN
Telephone **0234 843388** (10 lines) Fax **0234 840234**

All prices include VAT and delivery, specifications are subject to change without notice
All trademarks acknowledged, next day delivery £4.50 (U.K. mainland only)

TOP SECRET

Some of the many features Action Cartridge Super IV has to offer

Hardware:

Connects to the expansion port
Works with the A500 and A500+
Supports the new ECS chip set, kickstart 1.3 and 2.04
Works with 2MB chip RAM, 8MB of fast RAM
(Our competitor supports only 2MB of fast RAM)
Requires 1MB
Supports all popular hard disks
Trainer/slow motion mode for slowing the processor down
(with LED intensity control), making games easy to play
Automatic NTSC/PAL detect
Hardware works invisibly in the background
Cartridge control by two custom chips, so it does not block fast

memory

Supports printers
Supports up to 4 disk drives and 15 hard disk partitions

Software:

The latest X-Copy Professional integrated
Two cheat modes (Auto-cheat & manual cheat)
Auto-fire installer
Freeze game
Edit sprites
Sound and graphics can be saved to disk or hard disk in IFF
format, Soundtracker modules may also be saved in
Soundtracker format

(more than 27 versions of Soundtracker are being supported)

Play sound, forward or backwards, adjust play speed, limit
range to be played, zoom range for precise adjustment, save
Displays sound curve on screen with vertical showing the
position of memory being played
Trace and play Soundtracker modules
Machine language monitor/assembler with full screen editor
Bootblock virus checker
Install automatic slide show on disk for IFF format files
Filecopy for 1 or 2 drives
Back-up disks with two drives, visual support of progress
Two reset and clear memory options
Help screen upon pressing help button