

THE WORLD'S BEST-SELLING AMIGA MAGAZINE

WIN!
Two A4000s
in our amazing
Blitz Basic competition

AMIGA FORMAT

ISSUE 52 ■ NOVEMBER 1993 ■ £3.95

CREATE! Fully working version
Use the ultimate creative tool!
It's even more powerful
than AMOS!



AF 52a
Try your hand at programming with our fully working version of this superb new language
All Amigas
UP0009375
Play Defender and Zombie Apocalypse* both written in Blitz Basic 2
15
A1200 FIXES! Powermonger, Powermonger WW1, Jimmy White's and R-Type fixed for your AGA machine
*Contains scenes which may be disturbing to youngsters - 15 and over only!



AF 52b
Race on!
Take on the computer cars in this exclusive track from Team17's new viewed from above racer.
Overdrive
Megaworm
More fun than it looks

IT'S HERE!

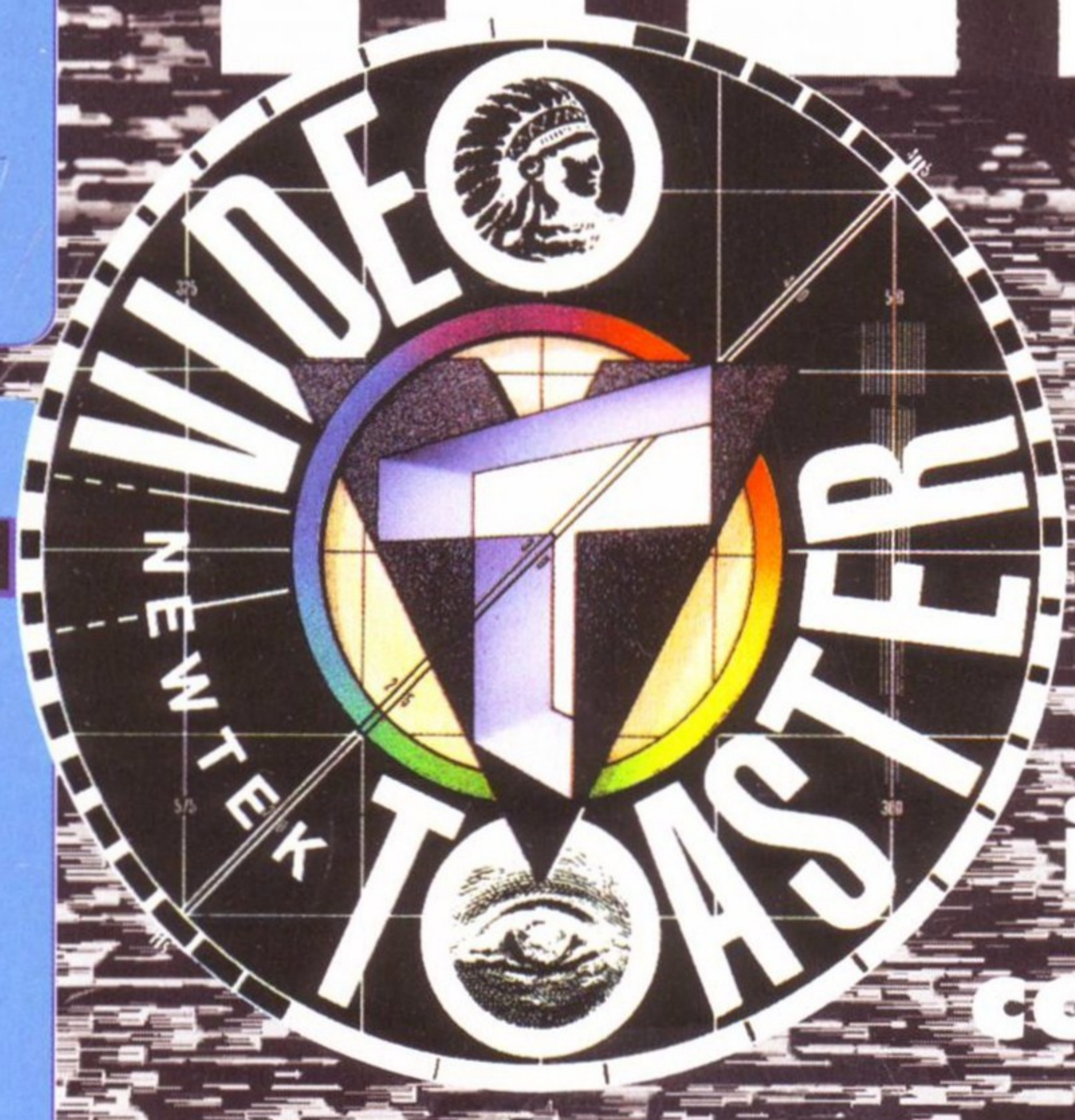

AT LAST! The greatest Amiga peripheral ever invented finally comes to the UK.

Don't miss our definitive ten page Video Toaster guide

BRILLIANCE: DPaint's downfall?
ELEVEN pages of tips & advice
FIFTY ONE products reviewed:
CD32 games, Micro Machines,

Future
PUBLISHING



technical hotline
0234 841882

power computing



PC880B POWER DRIVE

The award winning external disk drive which includes Anti-Click (cures that annoying click), Virus Blocker (prevents viruses) and built-in Backup hardware.

The PC880B is available with Blitz Amiga, Blitz and X-Copy or Cyclone compatible (this drive is only available to registered owners of X-Copy Professional. You must provide proof of purchase of X-Copy Professional). The drive comes in a choice of two colours, black or cream.

- PC880B WITH BLITZ AMIGA£60**
- PC880B WITH BLITZ, X-COPY ..£75**
- PC880B (CYCLONE COMPATIBLE)£65**
- PC880B IN BLACK CASE£65**

POWER DRIVES



- PC880E ECONOMY DRIVE ..£49.95**
- PC881 A500 INTERNAL£45**
- PC882 A2000 INTERNAL£45**
- POWER DUAL DRIVE£125**

3.5" SYQUEST DRIVE

3.5" removable hard drive from Syquest. Each cartridge stores 105MB.

- 3.5" SYQUEST DRIVE (17ms) ..£739**
- 3.5" 105MB CARTRIDGE£79**

BLITZ AMIGA

Backup disks at lightning speeds, and stop all external drives from clicking. Blitz does not let viruses from being written into the bootblocker. (The 1988 Copyright act applies)

- BLITZ AMIGA£15**

FLOPTICAL DISK DRIVE

The Floptical stores 20MB of data on a 3.5" disk (a SCSI interface is required).

- FLOPTICAL A2000 KIT£289**
- FLOPTICAL A500 EXTERNAL.....£389**

POWERSCANNER V3.0

The awarding winning PowerScanner is able to scan from 100 - 400DPI in 64 greyscales. The scanning software included allows you to edit and manipulate any image you scan.

The scanner interface includes a through port for a printer. (The Amiga only displays 16 greys)

- POWERSCANNER V3.0£99**
 - POWERSCANNER INC. OCR ...£149**
 - OCR JUNIOR SOFTWARE£49**
 - OCR FULL VERSION UPGRADE ..£49**
- (OCR full version is only available to registered users of OCR Junior)

COLOUR POWERSCANNER

Scan 100 - 400 DPI in 4096 colours, with the Colour PowerScanner.

The scanner interface includes a full through port.

- COLOUR POWERSCANNER£239**

POWERSCAN UPGRADES

If you consider your scanner system to be inferior to the Power Scanner, we will upgrade your software and interface.

- V3.0 UPGRADE (INC INTERFACE) ..£49.95**
- V3.0 UPGRADE (SOFTWARE, SEND SAE) £15**

EPSON GT-6500

High resolution 24-bit colour flatbed scanning from Epson. Scan up to A4 in size on this 600 DPI scanner. Comes with PowerScan software or ASDG software.

- EPSON GT-6500 (INC SOFTWARE) ...£799**

EPSON GT-8000

Power is official distributor for Epson
High resolution 24-bit colour flatbed scanning from Epson. Scan up to A4 in size on this 800 DPI scanner. Comes with PowerScan software or ASDG software.

- EPSON GT-8000 (INC SOFTWARE) ..£1199**

TRANSPARENCY ADAPTOR

Scan up to 5" x 4" transparencies. Available for the GT - 6500 and GT - 8000 scanners.

- TRANSPARENCY ADAPTOR.....£589**

DOCUMENT FEEDER

Automatic 50-sheet document feeder for the GT-6500 and GT-8000 scanners.

- DOCUMENT FEEDER.....£399**

A600 MEMORY CARD

1MB RAM with battery backed clock

- A600 1MB RAM£39.95**

PC501+ MEMORY CARD

Our RAM board is designed especially for the A500+ computer and comes with 1MB of RAM on-board to expand your memory to 2MB of chip RAM (fits in the trap-door).

- PC501+ MEMORY CARD£35.95**

1.5MB RAM BOARD

Fully supports 1MB of chip RAM and is fully compatible with Fatter Agnus (requires Kickstart 1.3 and above, not compatible with A500+. Your Amiga needs to be opened, this may effect your warranty).

- 1.5MB RAM BOARD£85**

1MB WITH THRU'PORT



Expand your A500's memory up to a total of 2MB without disposing of your existing 512K upgrade (works with 1MB chip RAM, 512K RAM must be 4 chip type or not exceeding 9cm in length. Your Amiga needs to be opened, this may effect your warranty).

- 1MB WITH THRU'PORT£49**

A500 MEMORY CARD

4 Chip 512K RAM expansion with or without battery backed clock.

Free software included (A500+ compatible)

- A500 CARD WITH CLOCK£29**
- A500 CARD WITHOUT CLOCK ..£24**

A500 8MB POWERBOARD

Expand your Amiga from 2MB to 8MB of RAM. Plugs into side slot, full auto config. and full through port.

- A500 2MB POWERBOARD£129**
- A500 4MB POWERBOARD£189**
- A500 8MB POWERBOARD£289**
- 1 X 4 ZIP£14.95**

A2000 8MB POWERBOARD

2MB to 8MB RAM expansion for the A2000

- A2000 2MB POWERBOARD£99**
- A2000 4MB POWERBOARD ...£149**
- A2000 8MB POWERBOARD ...£239**

COMMODORE AMIGA

A wide range of Amiga's are available.

A1200	£295
A1200 60MB HD	£475
A1200 80MB HD	£505
A1200 170MB HD	£660
A1200 212MB HD	£725
A4000 68040 120MB HD 6MB	£2329
A4000 68030 80MB HD 4MB	£1129
A4000 68030 80MB HD 2MB	£979

MONITORS

A wide range of monitors are available.

PHILIPS CM8833 MK2	£229
INCLUDES LOTUS 2, ON-SITE MAINTENANCE	
COMMODORE 1084S	£199
MULTISYNC MONITOR	£POA

ICD PRODUCTS



ICD sole distributor. Trifecta is SCSI 2 and IDE compatible. (Trifecta EC is only IDE)

TRIFECTA 2000 LX BARE	£139
80MB HD	£239
160MB HD	£329
200MB HD	£399
TRIFECTA 500 LX BARE	£195
80MB HD	£295
160MB HD	£359
200MB	£459
TRIFECTA 500 EC BARE	£145
80MB HD	£279
160MB HD	£339
200MB HD	£419
AD IDE 2 PRIMA BARE	£70
80MB HD	£245
160MB HD	£309
200MB HD	£399
PRIMA 3.5" MOUNTING KIT	£29
AD IDE 2 NOVIA 60MB HD	£259
80MB HD	£299
130MB HD	£379
212MB HD	£499
NOVIA 2.5" MOUNTING KIT	£19
ADSPED AMIGA	£119
FLICKER FREE VIDEO 2	£185

ELECTRIC FINGERS CLUB

The Power BBS is a bulletin board service. Phone 0234 841503. Speeds up to 16.8K

SUPRA MODEMS

SUPRA FAX MODEM+	£119
(INCLUDING PSU, CABLE AND SOFTWARE)	
SUPRA FAX MODEM 32BIS	£249

HOME MUSIC KIT

HOME MUSIC KIT	£69.95
MIDI INTERFACE	£15.95

GVP A530 TURBO HD

A 40 MHz 68030 EC accelerator.

80MB HD OMB RAM	£549
160MB HD OMB RAM	£649
200MB HD OMB RAM	£699
68882 UPGRADE KIT	£224

GVP SERIES 2 HD

External hard drive for the Amiga 500. Expand up to 8MB on-board.

80MB HD	£339
160MB HD	£409
200MB HD	£599
EACH 1MB X 8 SIMM	£30

CHIPS AND SPARES

We stock a wide range of parts and spares.

1MB X 8 SIMM	£30
4MB X 8 SIMM	£POA
SIMM 32 X 1MB-60 GVP	£59
SIMM 32 X 4MB-60 GVP	£179
SIMM 32 X 4	£159
SIMM 32 X 8	£369
256K X 4 DRAM	£5
1MB X 1 DRAM	£4.50
1 X 4 ZIP	£14.95
1 X 4 DIP	£19.95
PCMCIA 2MB	£149
V1.3 KICKSTART ROM	£24
V2.04 KICKSTART ROM	£32
FATTER AGNUS 8372	£30
BIG FAT AGNUS 8375	£40
HI-RES DENISE	£25
GARY	£19
PAULA	£25
6570-36 KEYBOARD CHIP	£19
CIA 8520	£9.95
DATA SWITCHES 2 WAY	£15.99
DATA SWITCHES 3 WAY	£17.99
DATA SWITCHES 4 WAY	£19.99
MODEM CABLE	£9.95
PRINTER CABLE	£6.95
SCSI CABLE	£9.95
IDE CABLE FOR A600, A1200 INC.	
INSTALLATION SOFTWARE	£15.95
A500 POWER SUPPLY	£39.95
WORKBENCH 2.04 KIT	£75

MISCELLANEOUS

POWERMOUSE	£15
OPTICAL MOUSE	£29.95
REPLACEMENT OPTICAL MOUSE MAT	£10
100 BRANDED DISKS + BOX	£69.99
10 BRANDED DISKS	£9.95
A1200 DUSTCOVER	£5
AVIATOR 1 JOYSTICK	£35
INTRUDER 1 JOYSTICK	£29.99
MAVERICK 1 JOYSTICK	£15.99
PYTHON 1 JOYSTICK	£9.99
APACHE 1 JOYSTICK	£7.99

POWER OPTICAL DRIVE

Fit 128MB on one Optical disk.

128MB OPTICAL INTERNAL	£849
128MB OPTICAL EXTERNAL	£999
128MB 3.5" OPTICAL DISK	£39.95
SCSI CONTROLLER A2000	£129

VIDEO BACKUP SYSTEM

Use a VCR as a backup storage device, 200 Amiga floppy disks fit on to a 4Hr tape which can be used for an alternative hard disk backup system. Whats more, you can watch television on your 1084S monitor.

VIDEO BACKUP SYSTEM

BARE SCSI HARD DRIVES

We can supply SCSI or IDE 3.5" drives in many sizes. These hard drives are suitable for GVP G-Force, GVP or ICD.

80MB	£179
160MB	£249
200MB	£349

2.5" IDE INTERNAL HD

Miniature hard drives for the A600/A1200 these drives come complete with a cable and installation software.

60MB INTERNAL HD	£179
80MB INTERNAL HD	£210
130MB INTERNAL HD	£299
170MB INTERNAL HD	£365
212MB INTERNAL HD	£430

GVP A2000 HARD CARD

High quality SCSI hard card.

BARE	£129
80MB	£279
160MB	£349
200MB	£419

AUTO ROM SHARER

One of the most advanced Rom sharers.

ROM SHARE	£19.95
ROM SHARE INC. V2.04	£50
ROM SHARE INC. V1.3	£39
ROM SHARE A600	£29
ROM SHARE A600 INC. V1.3	£55

Power Computing Ltd
Unit 8 Railton Road
Woburn Road Ind. Est.
Kempston Beds
MK42 7PN

Tel 0234 843388
Fax 0234 840234

Cheques payable to
Power Computing Ltd.

Goods are sold subject
to our standard terms
and conditions of sale
and are available on
request.

Specifications and
prices are subject to
change without notice.
All trademarks are
acknowledged.

All prices include VAT.

tel 0234
843388



delivery 24hr £4.50 48hr £2.50
parcel post £1 (UK mainland only
orders under £50)

Welcome to Amiga Format! This month's bumper issue brings you the latest and greatest on the Toaster. Thanks to John Allardice for his input on the cover.

Contents

AMIGA FORMAT

ISSUE 52 • NOVEMBER 1993

TOP NEWS STORIES



Woah! That's one hell of a bundle, Mr. Commodore.

Desktop Dynamite 27
Commodore deliver the best Amiga bundle ever, and it's AGA specific!

Amiga makes movies 28
The producers of *Wetware*, a new cyberpunk movie, turn to the Amiga.

World of Amiga 29
This year's FES show in London has a whole area devoted exclusively to the Amiga, so find out what's on at the World of Amiga...

Reviews

Brilliance 118
Is the latest of the Amiga paint packages the greatest? Probably!

Canon BJ-230 printer 122
Can Canon's latest addition live up to its bubblejet stablemates?

Origins 127
Tracing your family's history is easy with this genealogy program.

Macro68 assembler 129
Can DigiSoft's new assembler deliver as much as Devpac?

PCTask 130
Give your Amiga a new identity with this software PC emulator.

AccuTrans 3D 133
This 3D object converter program gets put through its paces...

QuarterBack Tools Deluxe 134
Does the new Deluxe version offer you more for your money?

Caligari 2 136
The fastest 3D modeller and renderer around put to work.

Bookshelf 138
The latest Amiga-related book releases – are they a good read?

Cross Stitch Pro 3 139
OK, so you might not enjoy stitching, but millions do.

US Robot 145
It may look silly, but this could be the best modem we've seen.



Can Brilliance give Amiga owners paint features they have never had? p118

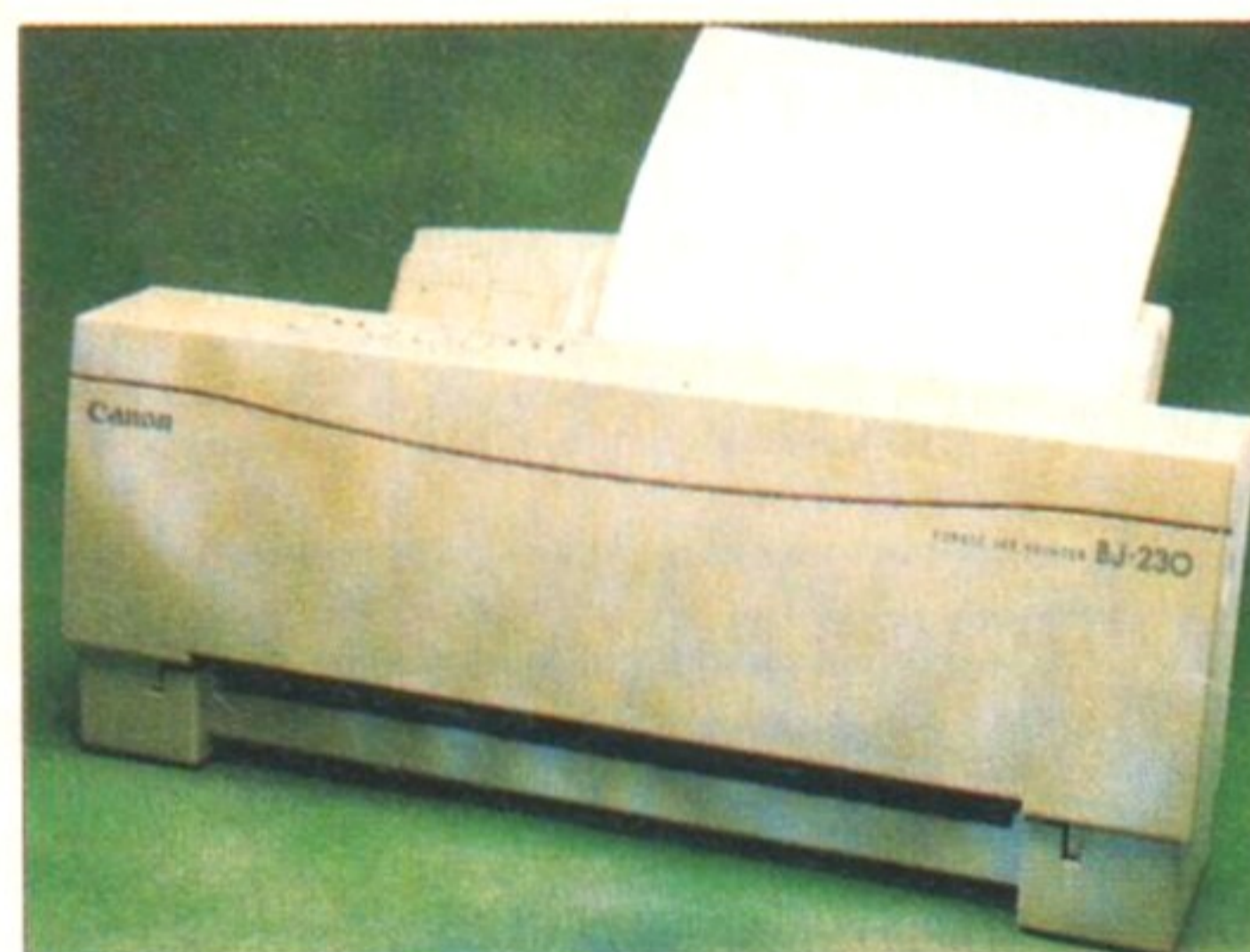

What can the Canon BJ-230 offer that other printers can't? p122



Does Caligari 24 have the power to render ray-trace fans speechless? p136



Can this Stylophone-like contraption improve your communications? p145

Regulars

Public Domain 153
The latest in free and nearly free software – is it worth getting?

Mail Order 172
Some of the best Amiga software and firmware to tempt you.

Back Issues/Subscriptions 168
Find out how you can get the mag plus a free newsletter and disk!

Workbench 177
If you've a problem with your Amiga, we'll solve it.

Letters 187

Next month 193

Here's what you've got to look forward to next time around...

Screenplay

Coming Attractions 55
Diggers CD³² 62



Remember that bar in *Star Wars*? Well, Jimmy Hill went in there when he wore his jeans with braces...

Burning Rubber 68
Space Hulk 70
Gearworks 74

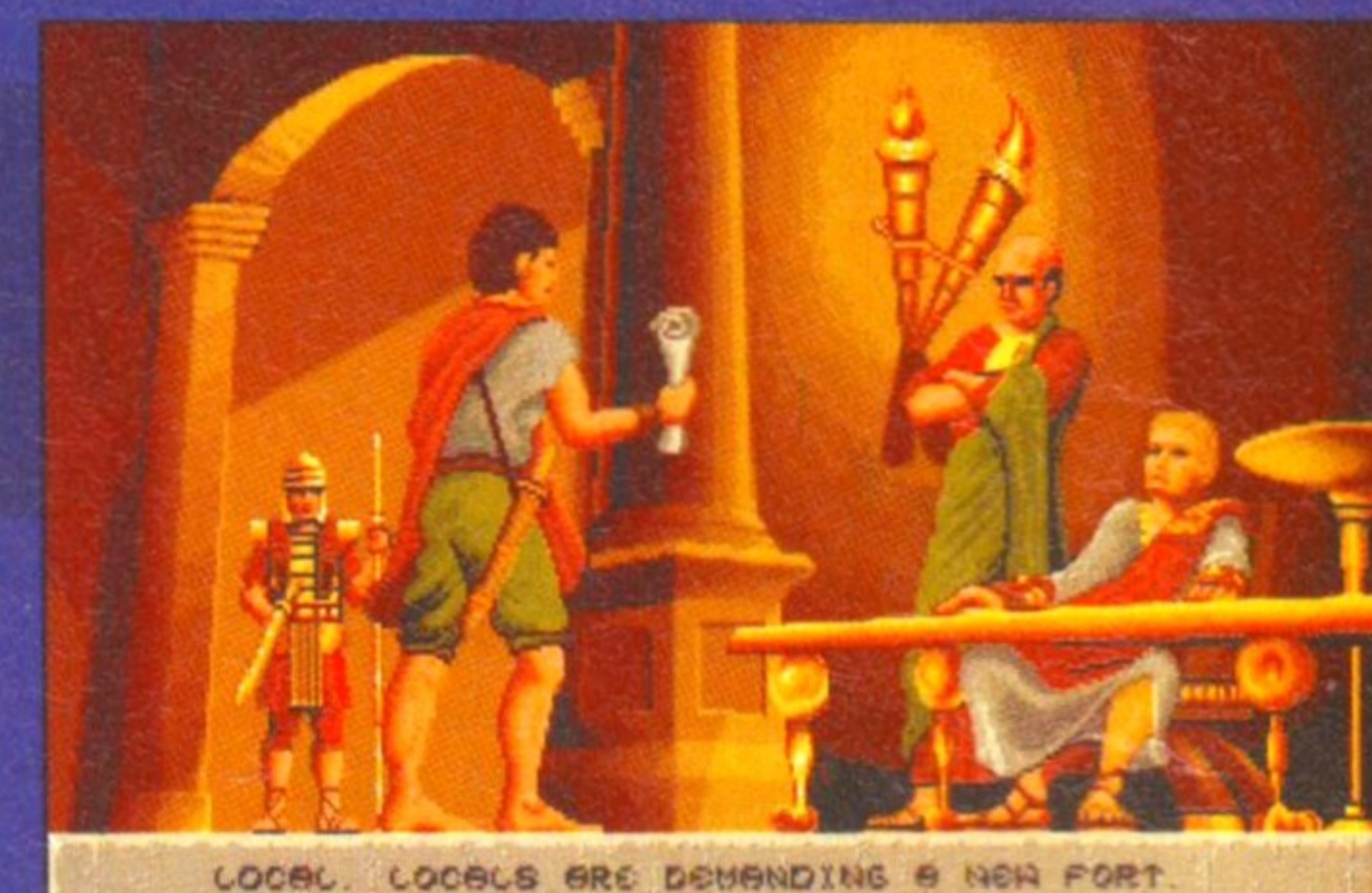

I came to bury Caesar, not to praise it! But it turned out to be really quite good... Drat!

On this month's Coverdisks

FOR FULL INSTRUCTIONS SEE PAGE 7

BLITZ BASIC
Try your hand at programming with our fully working version of this superb new language.
WPF0004075

Play Defender and Zaxxon
both with **Annalypse**

AT 200 FIXES! Powermanger, Jimmy White's and R-Type fixed for your Amiga.
*Contains scenes which may be disturbing to you.

Race on!
Take on the computer cars in this exclusive track from Team17's new viewed from above racer.

FOR FULL INSTRUCTIONS SEE PAGE 21

Overdrive
Megaworm
More fun than it looks



Someone once said: "Jesus saves, but St John scores on the rebound," and I laughed. Sorry. But can Ocean's *European Champions* level the score?

Whale's Voyage A1200	78
Civilization A1200	78
Morph A1200	79
1869 A1200/4000	79
European Champ'nship Soccer	80
UMS Complete Compilation	86
Caesar Deluxe	88
Micro Machines	96
Pinball Fantasies CD ³²	100
James Pond Robocod CD ³²	101
Budget game reviews	104

F17 (new release) ● Robin Hood ● Midwinter II - Flames of Freedom ● Super Space Invaders ● Grand Prix Circuit ● Shadowlands

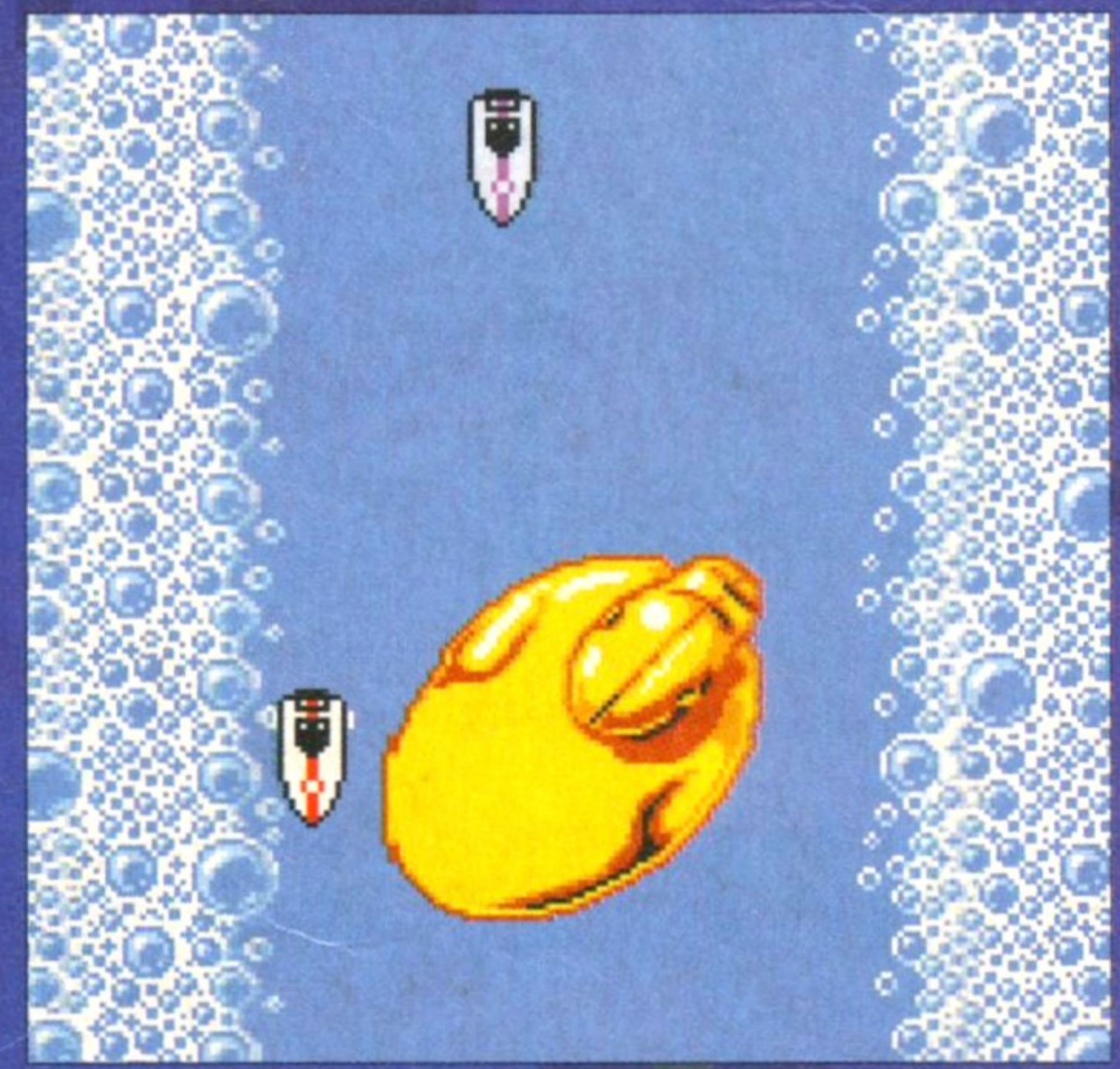

Many of you will have, no doubt, pondered the possibilities of racing powerboats in the bath. Probably.



Cover STORY

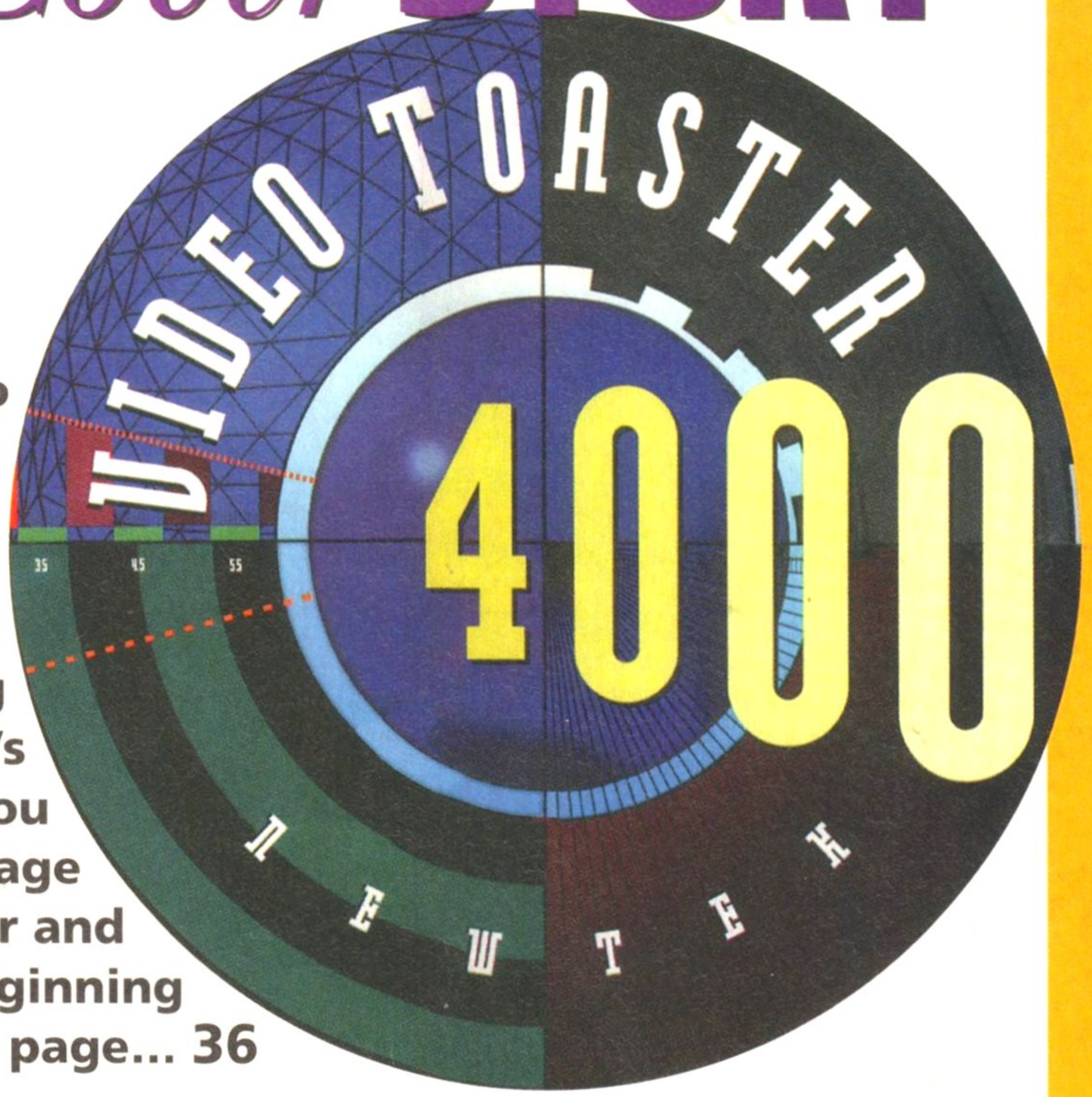

At last... the Video Toaster is here! This incredible complete video studio has been a long time coming to the UK. Now it's here we bring you the definitive 10-page guide to the Toaster and its features beginning on page... 36

COMPETITIONS!

Win two A4000/030s

Acid Software are offering aspiring Blitz Basic programmers the chance to win one of two amazing Amiga 4000s... page 114



Last time we offered you one. This time it's two. It's harder questions, though!

Win lots of stuff!

Our special Future Entertainment Show 'Get Creative' competition continues. You can win a Videopilot, an A1200, three Panasonic printers, an Amiga CD³² and last, but not least, a day's recording in a top studio, so turn quickly to... page 116



Blitz Basic

A full and completely working version of the most amazing Basic language you have ever seen. With Blitz you will be able to create stunning games and utilities. If you don't believe us, take a look at *Zombie Apocalypse*, coded totally in Blitz.

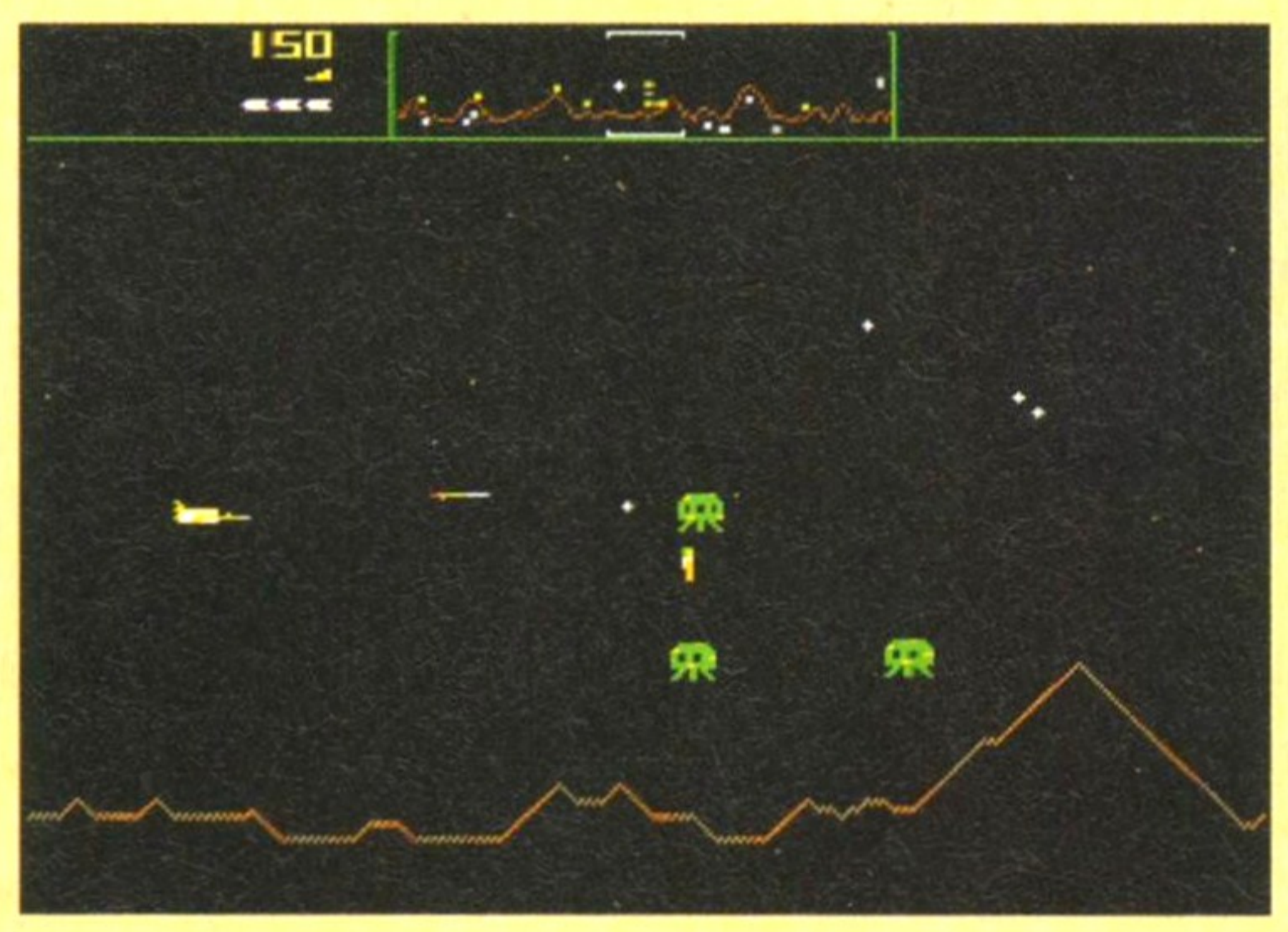

Defender

Another Blitz classic conversion, completely coded with the version of Basic on our Coverdisk. If you can tell this game was written in Basic, you must be an android. By the way, did we mention that Blitz Basic is on the disk too?



Overdrive

Viewed-from-above driving games are the flavour of this month. Apart from the fabulous *Micro Machines* there's *Team 17's Overdrive*. Play one exclusive level on this month's Coverdisk. And unlike other mags, our track has computer cars too!

Power Computing's latest 32-bit memory expansion for the Amiga 1200 is now available. The PC1208 combines exceptional value with incredible features. The original PC1204 4MB 32-bit memory expansion is still available, and is exceptional value.

SIMM Technology - The PC1208 uses the latest industry standard 32-bit SIMM technology allowing you to use 1MB, 2MB, 4MB and 8MB modules.

Zero Wait State - The PC1208 never leaves the processor waiting around for data, meaning your Amiga 1200 will run at its maximum speed. Simply adding either a PC1204 or PC1208 to your Amiga 1200 will increase its processing speed by 219%.

Real-Time Battery Backed Clock - Allows files to be date-stamped with the correct time and date so that you know exactly when they were created.

Ultra Fast FPU - With the addition of a maths co-processor intensive maths operations will be accelerated by up to fifty times. The PC1208 is the only memory expansion which offers the capability to take either PGA or PLCC type FPU's.

Easy To Fit - Fitted in minutes without the need to remove the computer's case. Does not effect your warranty.

PCMCIA Friendly - Unlike other expansion boards the PC1208 does not conflict with your Amiga 1200's card slot, using the PCMCIA friendly jumper even an 8MB SIMM can be used.

PC1208 Memory Expansion

PC1208 Bare **£70.00** **PC1208 FPU's add:**
 PC1208 1MB **£115.00** 20Mhz 68881 **£35**
 PC1208 2MB **£170.00** 33Mhz 68882 **£80**
 PC1208 4MB **£270.00** 40Mhz 68882 **£114**
 PC1208 8MB **£465.00** 50Mhz 68882 **£154**

PC1204 Memory Expansion

PC1204 4MB no FPU **£185.95**
 PC1204 20MHz 68881 **£219.95**
 PC1204 25MHz 68882 **£279.95**
 PC1204 33MHz 68882 **£289.95**
 PC1204 40MHz 68882 **£299.95**
 PC1204 50MHz 68882 **£339.95**

The PC1204 & PC1208 Memory Expansion for the Commodore Amiga 1200.



The XL 1.76MB Internal & External Drive for the Commodore Amiga.



Power Computing's XL 1.76MB Drive* for any Commodore Amiga is now available. The XL Drive includes these many features:

Formats to 1.76MB - Using high density disks you can fit a massive 1.76MB on each disk.

Acts as a standard drive - Insert an 880K Amiga disk and the drive behaves like any other Amiga drive.

Fully compatible - Will read and write disks written on an Amiga 4000 internal high density drive.

Compatible with PC disks** - Also read and write high density PC disks using a suitable device driver.

Compact size - No larger than a standard 880K floppy disk drive.

High quality design - Uses a high quality Sony high density mechanism.

Easy to Fit - The external XL Drive simply plugs into the floppy drive port at the rear of your Amiga. The internal XL Drive simply replaces or adds to your existing drive(s). These drives can be installed in minutes and no soldering is required.

Software compatible - The XL series is fully compatible with all existing hardware and software.

External XL Drive £99.95
Internal XL Drive £89.95
A4000 Internal XL Drive £99.95

*Requires Kickstart 2 or above. **Requires Workbench 2.1 or above.

48Hr delivery **£2.50**, 24Hr delivery **£4.50**
 Parcel Post delivery **£1** (Orders under £50 & UK mainland only)
 Specifications and prices subject to change without notice
 All Trademarks acknowledged. VAT included



Power Computing Ltd
 Unit 8 Railton Road Woburn Road Industrial Estate
 Kempston Bedford MK42 7PN
Tel 0234 843388 Fax 0234 840234

Goods are sold subject to our standard terms and conditions of sale and are available on request.

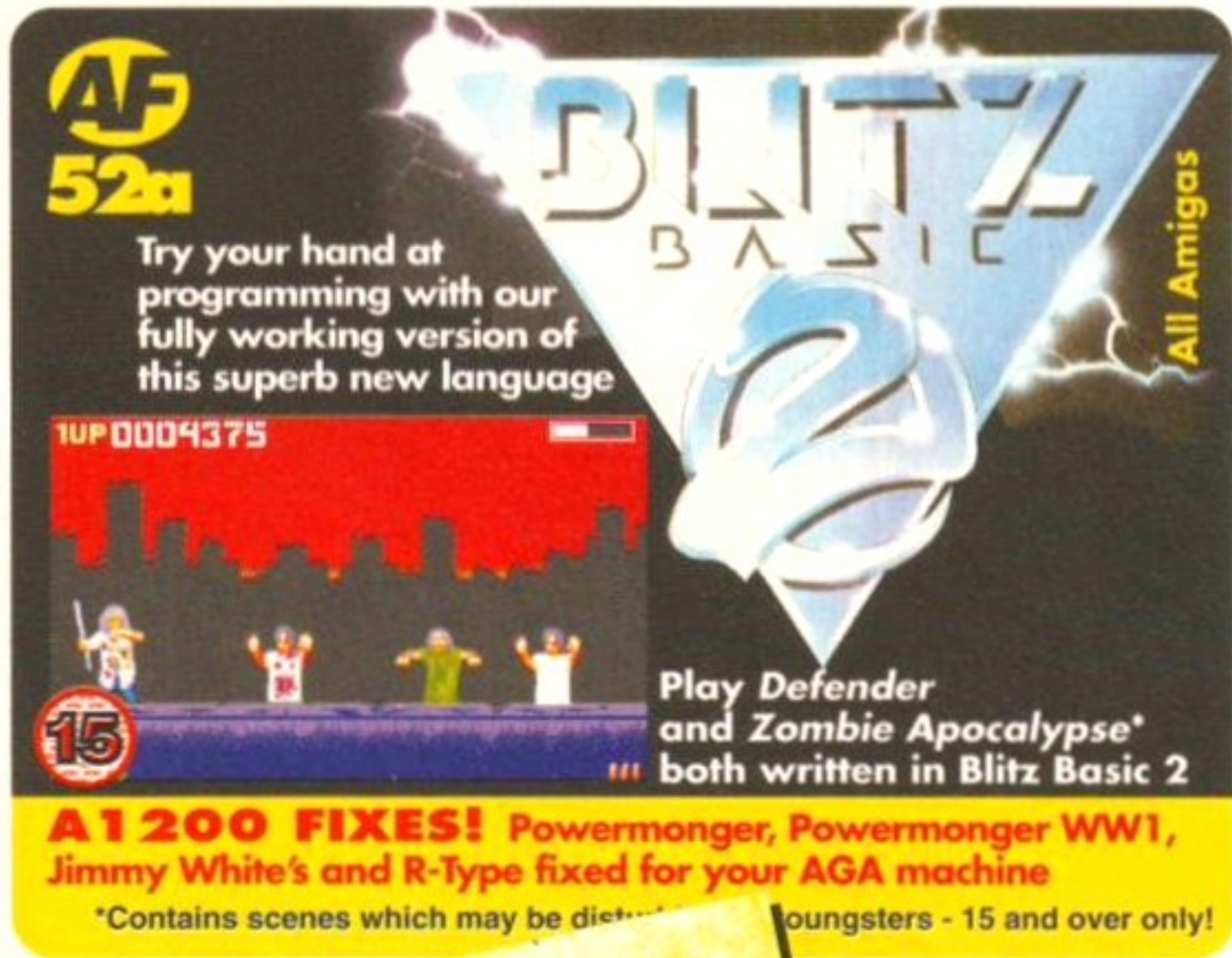

BLITZ BASIC

So you're lucky enough to have a full working copy of Blitz Basic. But what do you do with it? Write brilliant programs, of course. And on the next 10 pages we show you how in the first of our mega tutorials.

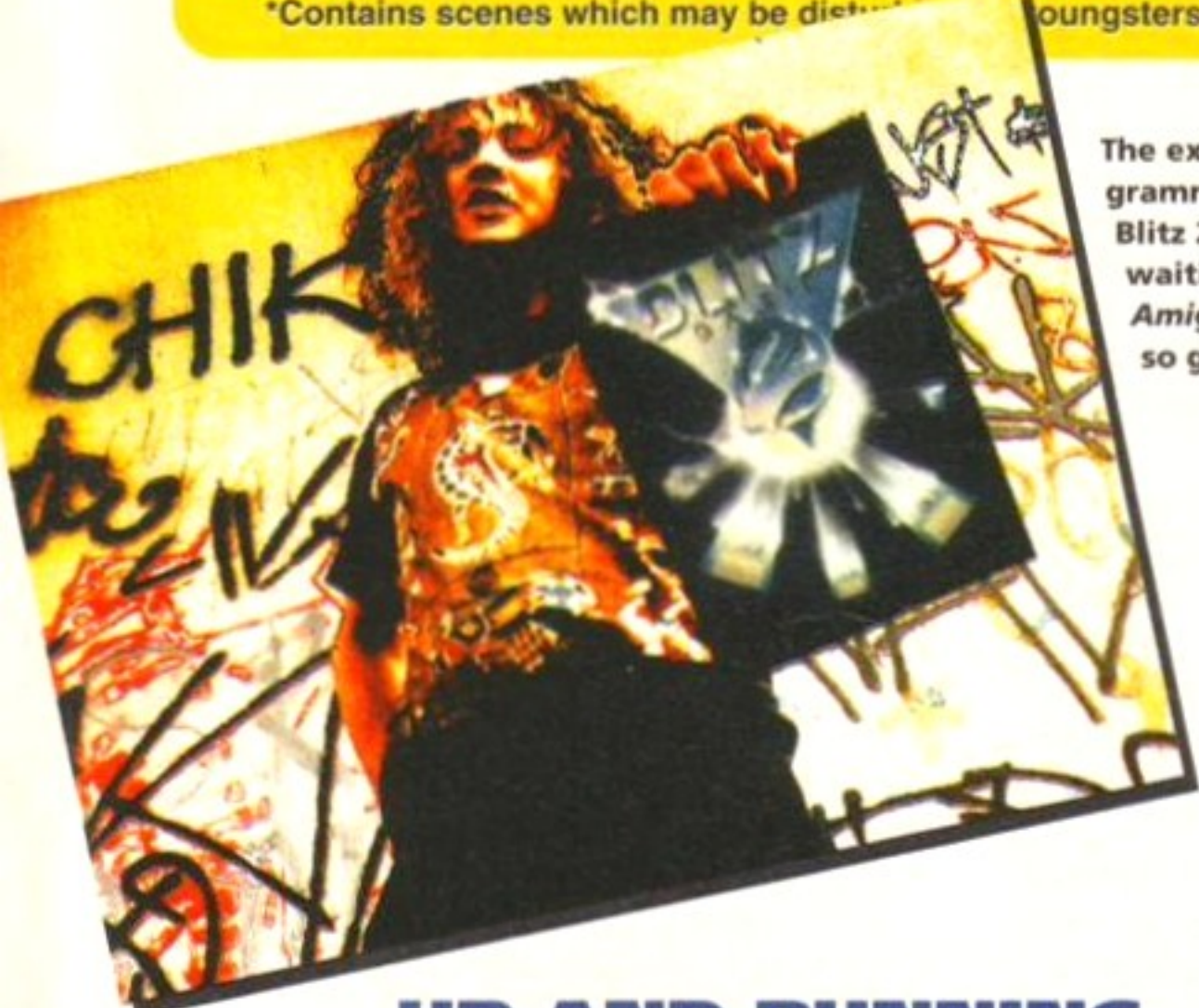

The excellent new programming language - Blitz 2 - is ready and waiting on this month's Amiga Format Coverdisk, so get programming!

UP AND RUNNING

The Blitz 2 Coverdisk this month features the complete Blitz 2 language. The three components that make up the language are:

- Blitz 2: the compiler**
- Ted: the editor**
- Deflibs: the command libraries**

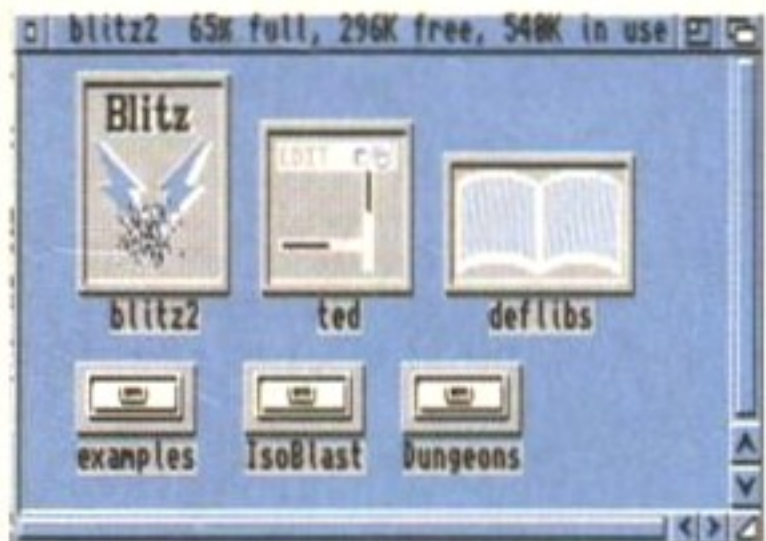

When you load your Coverdisk, these icons will appear on your screen.

To start programming in Blitz 2 just click on the Blitz 2 icon from Workbench. As Blitz 2 is a combination editor-compiler the other two files Ted and Deflibs must always be present in the same drawer.

Harddisk users can install Blitz 2 on their system simply by creating a new drawer on their hard disk and dragging the three files from the Coverdisk into it. The line

BEFORE YOU START

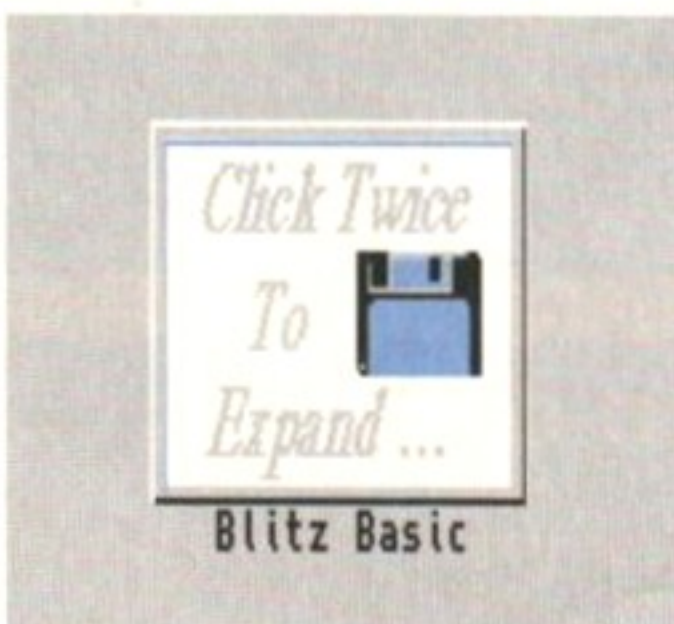

Welcome to yet another fabulous Coverdisk. This time you lucky people have got your hands on one of the most powerful and simple to use programming languages available, which will allow you to create everything from arcade quality games to top notch utilities.

Amazingly, the entire programming system has been packed on to one disk - one which you will have to expand before you can get cracking. To do this simply follow these steps:

- 1 Have a blank disk ready.
- 2 Restart your machine and insert Coverdisk 52A (make sure that it is write-protected).
- 3 When Workbench has loaded, double-click on the disk icon and wait for the window to open.
- 4 Locate the Blitz icon (it's the very big one) and double click on it.
- 5 A window will open and ask you to hang on for a moment. Do this - don't touch anything.
- 6 Eventually a message will appear asking you to insert a disk into df0: and press return. At this point remove your Coverdisk.
- 7 Insert your blank disk and press return. The data will now be written on to the disk.
- 8 When the process is finished you will be asked to insert your Coverdisk again. Do this.
- 9 Now you can remove your Coverdisk and insert your brand new Blitz Basic disk. Have fun!

ASSIGN BLITZ2: HardDriveName:DrawerName

should then be added to the hard drive's startup-sequence.

OKEE DOKEE!

After Blitz 2 is up and running select OKEE DOKEE and you're ready to type in your first Blitz 2 program:

```
Print "THUMBS UP DUDE!"
MouseWait
```

To run the program, select the Compile/Run option from the COMPILER menu. A Blitz 2 CLI window appears with your message printed across the top, unless of course you have made a typo in your first program, not a

Continued overleaf



Getting Blitz 2 up and running is easy - just follow our simple step-by-step guide and you won't go wrong.

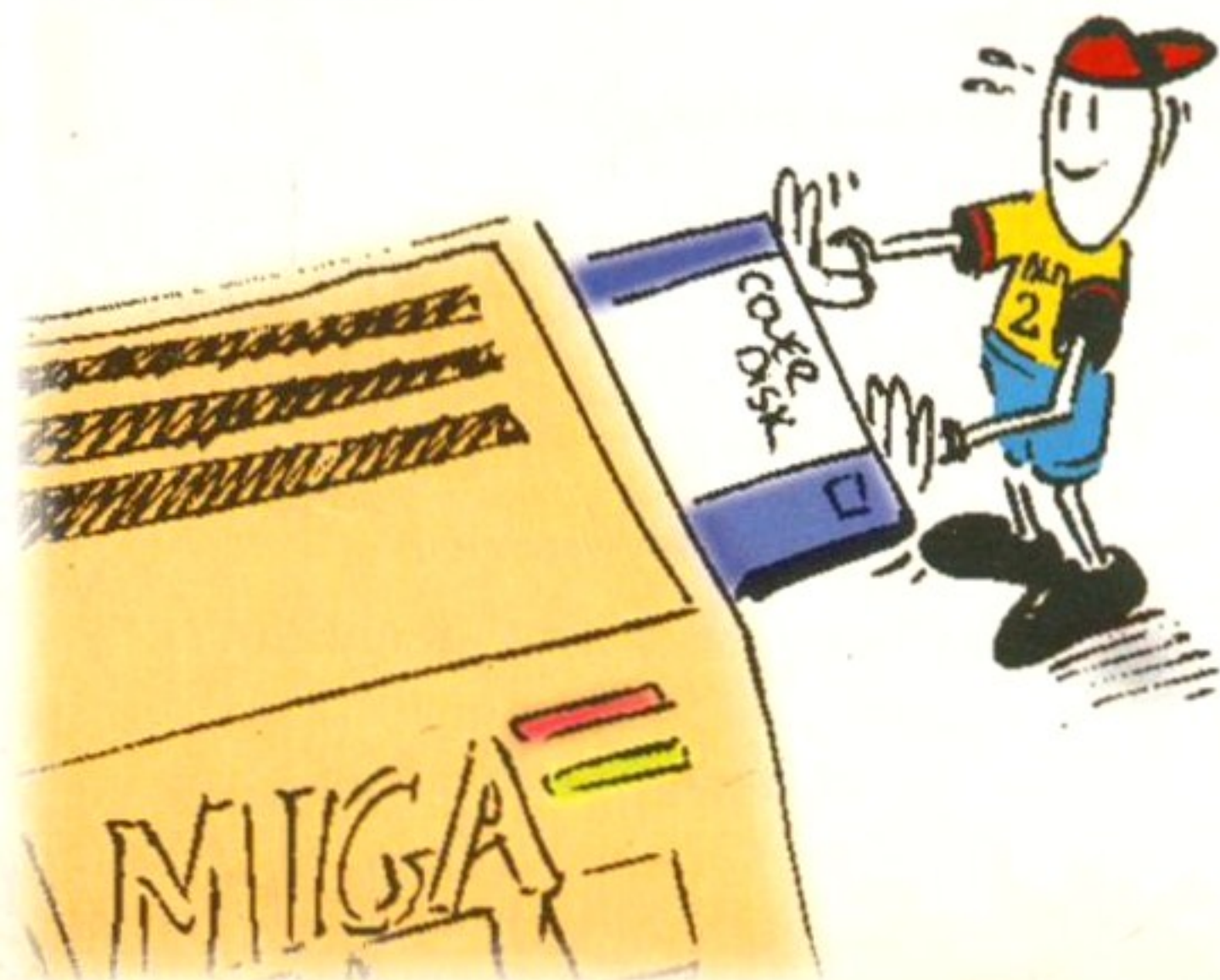

THE BLITZ 2 DEBUGGER

Blitz 2 comes with a very powerful debugger that will tell you if anything goes wrong when your program is running. The RuntimeDebugger must be activated (via the compiler options requester) if you are to make use of it. If your program has an error and the runtime debugger is not activated, the chances are you will crash the system. Once you have your program error free, disabling the debugger will allow you to run your programs at near machine code speeds.

To stop the program that continuously prints "YOZA" we could invoke the debugger by hitting Ctrl+Alt+C. The STOP command can also be added anywhere in your code to invoke the Blitz 2 debugger. Some of the keyboard controls that can then be used with the Blitz 2 debugger:

H - Hide/Show debugger
 S - single step through the program
 I - ignore current command (skip to next one)
 T - trace program execution
 D - display 68000 registers
 R - resume full speed program execution
 Q - quit back to Ted (also use ESC)
 B - backup through previously executed commands
 F - forward step through previous commands (after B)

Warning! At present the special display used by the debugger is not compatible with DbIPAL displays. Those programming with such monitors should insert the DbIPALFix.bb code at the top of all their Blitz 2 programs (see Coverdisk).

SOME TED KEYBOARD CONTROLS

Return - move cursor to new line
 ShiftReturn - break line at cursor position then move cursor to new line
 ShiftLeftArrow - move cursor to same indent as line above
 F1 - mark block start
 F2 - mark block end
 F3 - block to disk
 F4 - paste block
 ShiftF3 - delete block

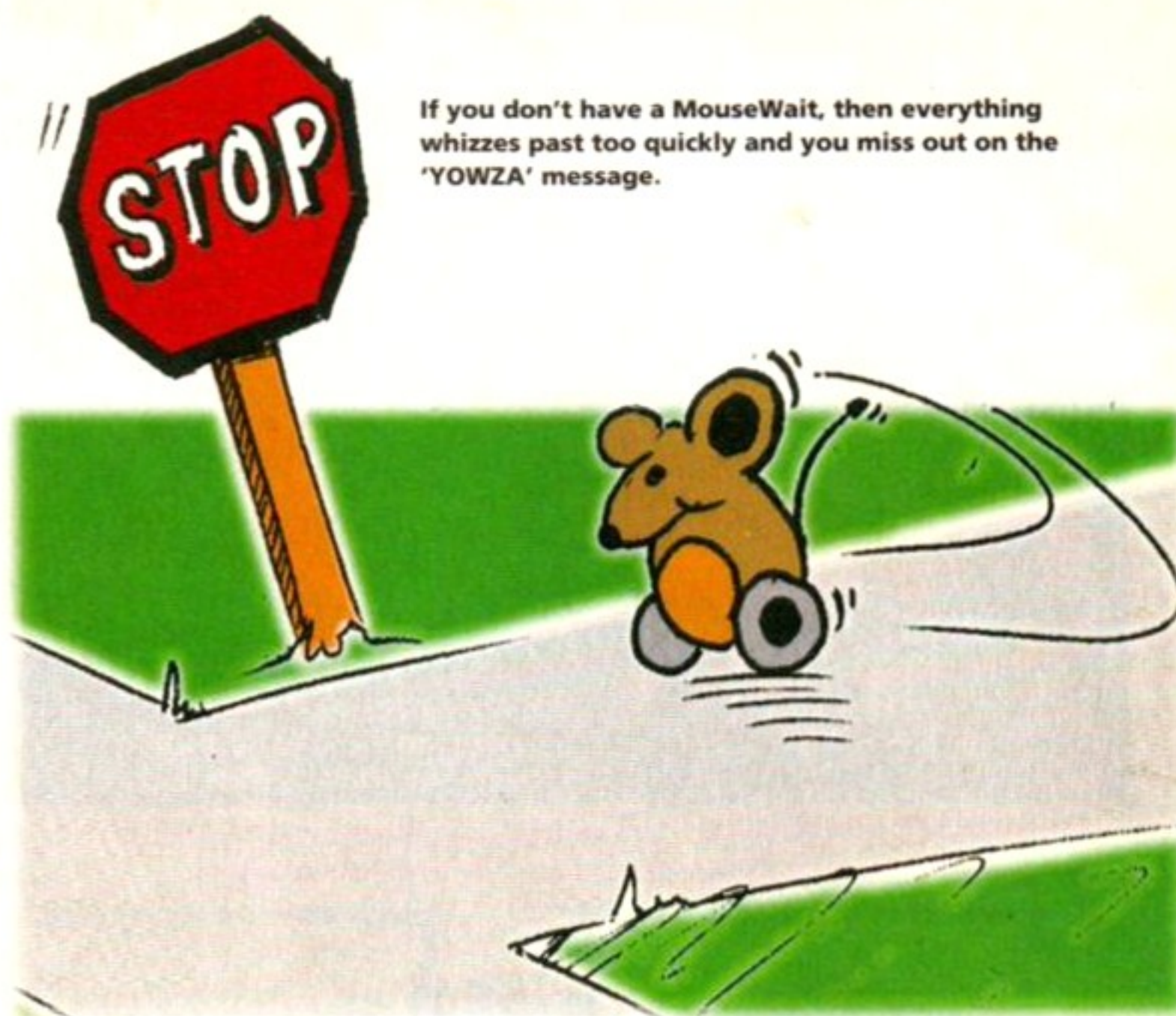

If you don't have a MouseWait, then everything whizzes past too quickly and you miss out on the 'YOWZA' message.

good start! Click the mouse button to return to the Blitz 2 editor.

So why the MouseWait you ask? Delete the second line and find out. Ha! So if you don't have a MouseWait you don't get a chance to read the message, the program runs but finishes and returns to Ted before you get a chance to read the message!

If you wanted to keep printing the same message over and over again until the mouse button was pressed we would use the following code:

```
While Joyb(0)=0 ;repeat while the mousebutton isn't down
Print "YOWZA!"
Wend
```

Weird huh? If we wanted each message to appear on a new line rather than all jumbled up together we could replace the Print command with NPrint. Note how we use a semi colon before the remark on the first line instead of the old Rem statement.

LOADING THE EXAMPLES

"OK, that's all very exciting but let's see some good stuff," I hear you say. In that case it's time to have a look through the examples drawer that comes on

MONSTA'S IN THE DUNGEON BY SIMON ARMSTRONG

```
DEFTYPE .w ;all variables are integers
console=False ;make true to run on std console (cli)
width=128 ;standard map size as in editor
height=64
size=width*height
dispw=32
disph=16 ;display width and height
map$="map1"
nummonsters=256 ;maximum number of monsters

If console
home$=Chr$(9b)+"H":mycls$=home$+Chr$(9b)+"J" ;strings for consoles
Else
FindScreen 0
Window 0,20,20,270,170,$1400,"MONSTER GAME",1,2
WindowInput 0:WindowOutput 0
EndIf

NEWTTYPE .monstype ;the monster object
x.w:y.w
End NEWTYPE

Dim List monster.monstype(nummonsters) ;loads of monsters!

Dim c$(4):c$(0)=Chr$(32):c$(1)="":c$(2)="O":c$(3)="M":c$(4)="B"

Dim map.b(width-1,height-1) ;standard 2D array for the map

.maingame:
turn=0:gameover=False ;reset game variables
myx=10:myy=10 ;in case no B found on the map
Gosub readmap ;read file map$ into map array
Gosub welcome ;do front end
Repeat ;main loop
Gosub drawmap ;refresh display
Gosub yourmove ;get player's move
Gosub monstermove ;move the monsters
Until gameover=True
Print "PLAY AGAIN? (Y/N)"
If UCase$(Edit$(1))="Y" Then Goto maingame
End

.readmap
If ReadFile(0,map$) ;if file found
ReadMem 0,&map(0,0),size:CloseFile 0 ;raw read into array
ClearList monster() ;find the monsters!
For x=0 To width-1:For y=0 To height-1 ;and record all their
If map(x,y)=3 ;positions in list
If Additem(monster()) Then monster()x=x,y
EndIf
If map(x,y)=4 Then myx=x:myy=y ;found BMan's start position!
Next y,x
Else
End ;couldn't find file (we're in the wrong directory?)
```

the disk. Select Load from the PROJECT menu. Then select any of the files in the examples drawer that end with the suffix ".bb2".

THE EXAMPLES:

```
dualpf.bb2           ;example code for opening a dualplayfield display
scroller.bb2        ;gosh hardware scrolling is fast!
palette.bb2         ;simple palette requester
converter.bb2       ;converts decimal hex binary using string gadgets
scrolling.bb2       ;* endless horizontal scrolling
menus.bb2           ;* groovy menus
windows.bb2        ;example of opening different windows
darts.bb2           ;hardcore example of machine code meets Blitz2
```

*** WARNING!**

The small CD gadget on the Blitz 2 file requester is very important. Programs that access files often expect them to be located in the same drawer as the program itself. Clicking on CD in the file requester will change the "current directory" to that listed in the "path" field.



With your first Blitz project you will encounter many a frightening monster in deep, dark dungeons!

A LIST OF SOME WINDOW EVENTS AND THEIR CODES

Window has been sized	\$2
Mouse was Clicked	\$8
Gadget has been pressed down	\$20
Gadget has been released	\$40
Menu selected	\$100
Window Has been closed	\$200
Window Activated	\$40000

If you want to change the above program so that it only ends when the user selects the close gadget in the window you would replace the WaitEvent with the following:

```
Repeat
ev.l=WaitEvent           ;ev (a long word) holds the event code
Until ev=$200
```

You can now size the window and our program will ignore such an event and go back to sleep! The only event it will actually take note of is the CloseWindow event.

The next thing you will want to do is add Menus and Gadgets to the program so the user has something to play with besides moving windows around (a novelty that soon wears off after first buying your new Amiga).

- For example if you try and run the "scrolling.bb2" example without making the examples directory the "current directory" the program cannot run. Select Load again but this time click on CD before OK to make the examples drawer the current directory.

PROJECT 1 - STRAIGHT TO THE DUNGEON!

MONSTAS IN THE DUNGEON!

The first project for this feature is a simple text based game with a fully functional Intuition based editor to accompany it. Text based dungeon games where the monsters are the letter M go back to the first mainframes.

Because this version works with a standard console window I was able to get it running as a "DOOR" on a local BBS so people could dial in and play it on-line.

The game at present is really only a working shell. The aim was to keep it simple and concise, not fill it with complex monsta psychology.

Continued overleaf

```
EndIf
Return

.welcome:
NPrint "WELCOME TO THE DUNGEON!"
NPrint " HIT RETURN TO PLAY"
a$=Edit$(1):Return

.monstermove:
USEPATH monster()
ResetList monster()
While NextItem(monster())
map(x,y)=0 ;clear current pos on map
dx=Sgn(myx-x):dy=Sgn(myy-y) ;calc direction to move in
oldx=x:oldy=y ;remember old pos
If Rnd(2) ;home in on either x or y priority
If dxThen \x+dx Else \y+dy
Else
If dyThen \y+dy Else \x+dx
EndIf
Select map(x,y) ;whats in new pos?
Case 0:map(x,y)=3 ;empty space cool!
Case 1:\x=oldx:\y=oldy:map(x,y)=3 ;wall back up!
Case 2:map(x,y)=1:KillItem monster() ;down a hole!
Case 3:\x=oldx:\y=oldy:map(x,y)=3 ;another monster!
Case 4:NPrint "HA GOTCHA!":gameover=True ;he got me!
End Select
Wend
If NOT LastItem(monster()) Then NPrint "SUCCESS!":gameover=True
```

```
Return

.yourmove:
turn+1:Print "Turn #",turn," (U,D,L,R or Q) "
map(myx,myy)=0 ;rub out old position
Select UCase$(Edit$(1)) ;edit$=input
Case "U":If map(myx,myy-1)Then myy-1 ;up
Case "D":If map(myx,myy+1)Then myy+1 ;down
Case "L":If map(myx-1,myy)Then myx-1 ;left
Case "R":If map(myx+1,myy)Then myx+1 ;right
Case "Q":Print "BYE NOW":End ;quit
End Select
If map(myx,myy)=2
NPrint "ARRRRR YOU FELL DOWN A HOLE!":gameover=True
Else
map(myx,myy)=4 ;place in new position
EndIf
Return

.drawmap:
If console Then Print home$ Else WLocate 0,0
posx=QLimit(myx-dispw/2,0,width-dispw)
posy=QLimit(myy-disph/2,0,height-disph)
For y=0 To disph-1
For x=0 To dispw-1:Print c$(map(posx+x,posy+y)):Next:NPrint ""
Next
Return
```

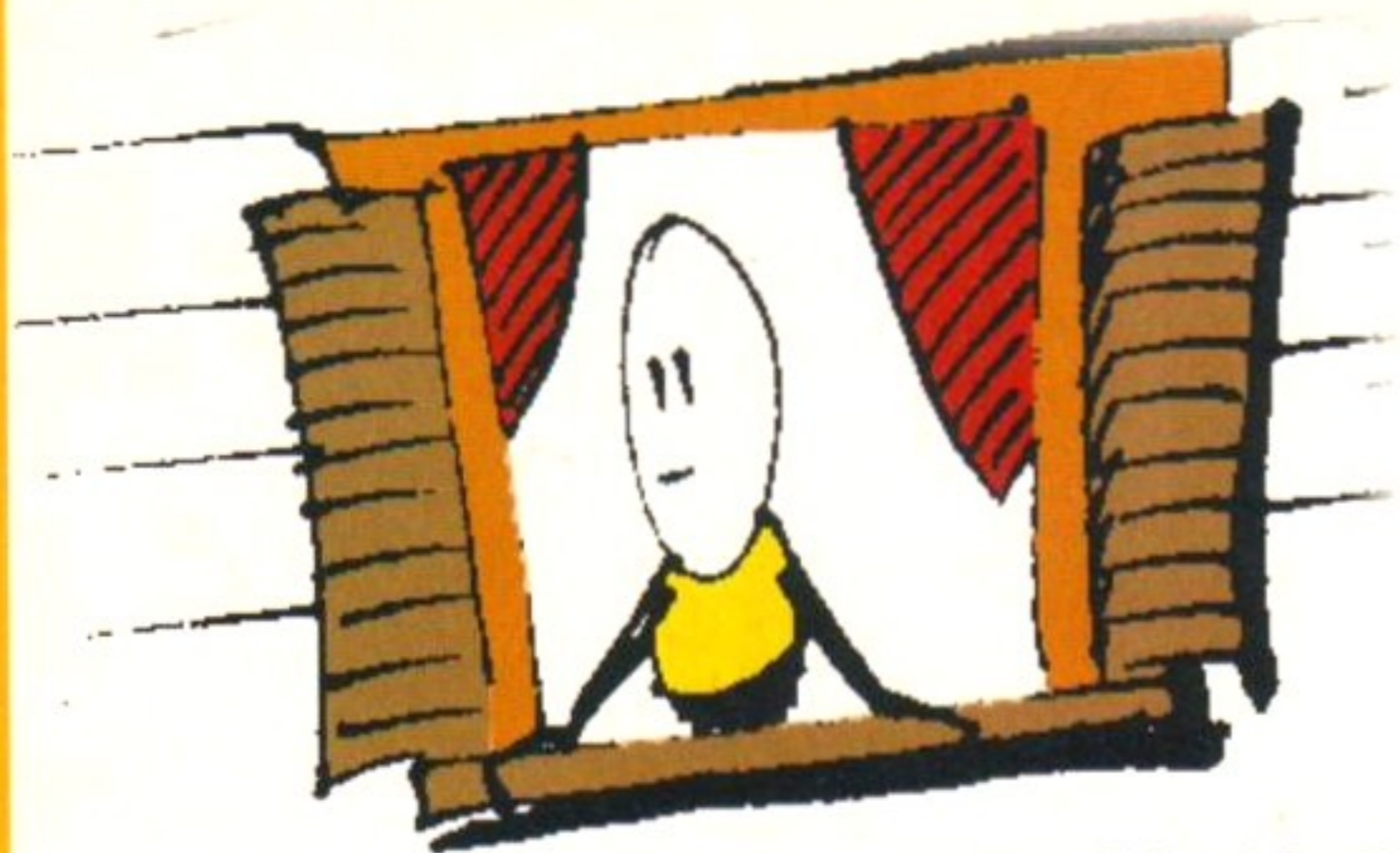

Yes - this is a window. And the only event the program will take note of is the CloseWindow one!



THE DUNGEON EDITOR

One very powerful feature of Blitz 2 is the ease in which you can use the Amiga's own operating system Intuition in your programs. The following code will open a new Screen and open a Window on that screen:



The main loop in the editor listing shows you how to handle menu requests.

```
Screen 0,10,"My Screen"
Window 0,0,12,640,240,$100f,"My Window",1,2
WaitEvent
```

Now that we are going to be using windows in our programs we can abandon the MouseWait command in favour of WaitEvent. With Intuition information about what the user is doing is passed to your program in the form of "Events".

The WaitEvent command will put our program to sleep (so it doesn't hog CPU time in the Amiga's multitasking environment) until the user clicks on the mouse, types a message, and so on.

MENUS

Menus must be defined before you open any Windows in Blitz 2. Menus are made up of titles such as PROJECT and EDIT. Off these titles are MenuItems and from these there are sometimes even SubMenus.

To add a menu that has a Quit option, we would use the following code:

```
MenuTitle 0,0,"PROJECT"
MenuItem 0,0,0,0,"QUIT ","Q" ;even has a keyboard shortcut!
```

After the Window command we would attach our Menu to the new window with the SetMenu command, in this instance:

```
SetMenu 0
```

After getting a menu event (code \$100) the functions MenuHit and ItemHit return which item in which list the user selected. Have a look at the main loop in the editor listing to see how to handle the Load, Save and Quit menu requests.

GADGETS

Gadgets are the buttons that appear on windows making good Amiga software such a joy to use. Blitz 2 supports various types of Gadgets for you to add to your program, your editor makes use of text gadgets and proportional gadgets (sliders), we will cover string and shape gadgets next month.

As with Menus, gadgets must be created before Windows are opened in your Blitz 2 programs. The following code opens a Window with three text gadgets and prints a message each time the user presses one of them. Just to be annoying, the window jumps in a random direction after a button is selected! Note the GadgetHit function is similar to the MenuHit function and contains which gadget caused the event.

DUNGEON EDITOR BY SIMON ARMSTRONG

```
width=128 ;map/dungeon constants same as dungeon.bb
height=64
size=width*height
```

```
MaxLen pa$=160 ;fix length of strings for use with Blitz2
MaxLen fi$=64 ;filerequester
```

```
Gosub initmap ;dimension array and draw border
Gosub initchars ;string array for our objects
Gosub initui ;open user interface
Gosub sizewindow ;refresh map window
```

```
Repeat ;main loop based on Intuition events
```

```
  ev.l=WaitEvent
  Select ev
    Case 2
      Gosub sizewindow
    Case 8
      If EventWindow=0 AND MButtons=1 Then Gosub draw
    Case $40
      If GadgetHit
        posy=Int(VPropPot(0,0)*height) ;scroll map
        posx=Int(HPropPot(0,1)*width)
        Gosub drawdungeon
      Else
        brush=GadgetHit-2 ;select brush from tool window
```

```
  EndIf
  Case 256
    If MenuHit=0 AND ItemHit=0 Then Gosub loadmap
    If MenuHit=0 AND ItemHit=1 Then Gosub savemap
    If MenuHit=0 AND ItemHit=2 Then End
  Case $40000
    Use Window 0:Redraw 0,0:Redraw 0,1
```

```
  End Select
  Forever
    .initmap
    Dim map.b(width-1,height-1)
    For y=0 To height-1:map(0,y)=1:map(width-1,y)=1:Next
    For x=0 To width-1:map(x,0)=1:map(x,height-1)=1:Next
    Return
```

```
  .initchars
  Dim c$(4)
  c$(0)=Chr$(32):c$(1)="*":c$(2)="O":c$(3)="M":c$(4)="B"
  Return
```

```
  .draw
  Repeat
    Use Window 0
    cx=QLimit(Int((WMouseX-6)/8),0,ww-1)
    cy=QLimit(Int((WMouseY-10)/8),0,wh-1)
    map(posx+cx,posy+cy)=brush
    WindowOutput 0:WLocate cx*8,cy*8:Print c$(brush)
  Until Event
```

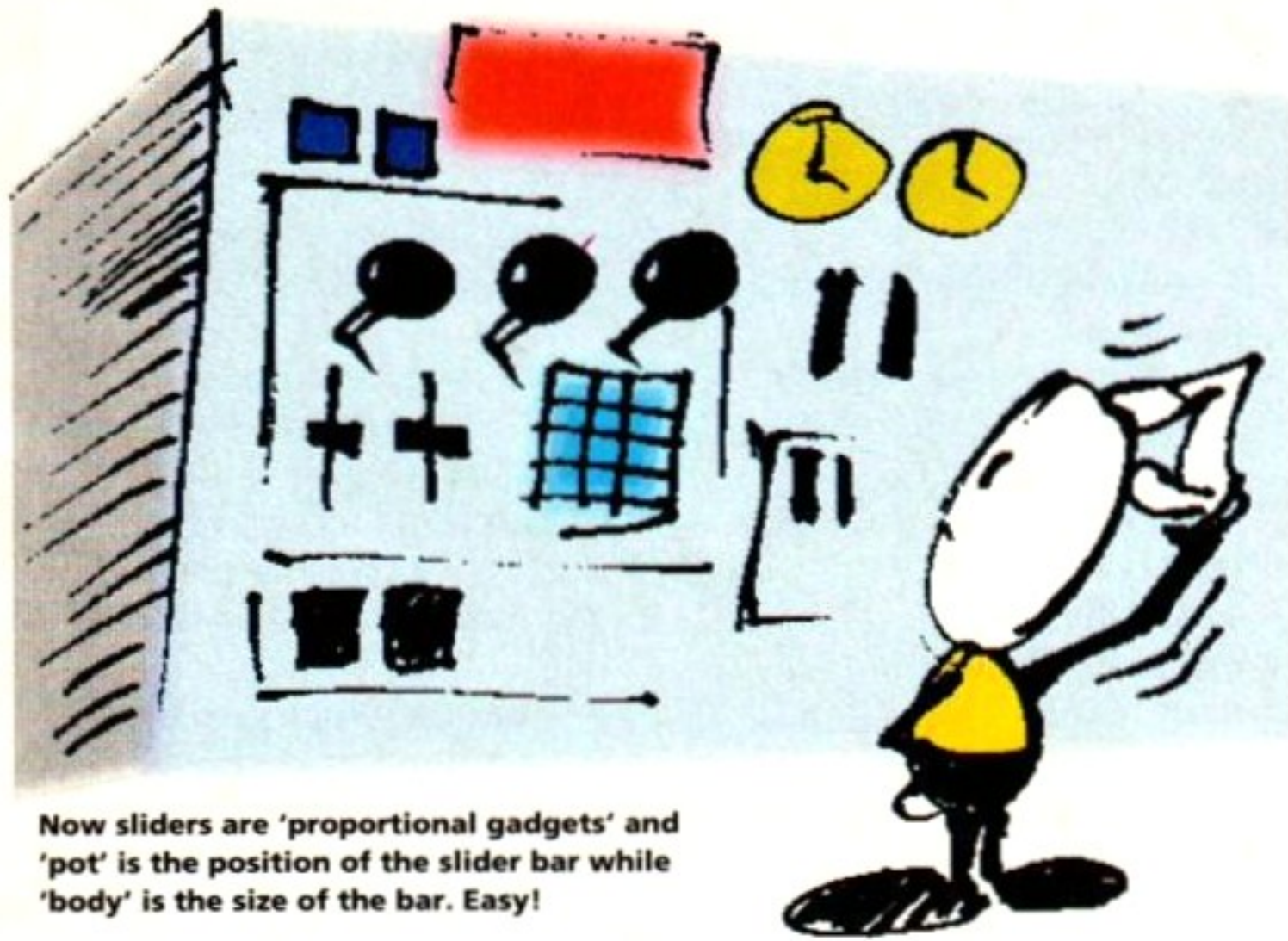

Now sliders are 'proportional gadgets' and 'pot' is the position of the slider bar while 'body' is the size of the bar. Easy!

```

Dim a$(3) ;string array to hold message in
For i=0 To 2 ;set up our 3 buttons
Read a$(i),b$ ;across the window
TextGadget 0,20+i*80,14,0,i,b$
Next
FindScreen 0 ;find workbench screen
Window 0,20,20,300,40,$100f,"CLOSE ME",1,2,0 ;open window
win.l=Peek.l(Addr Window(0)) ;actual location for system calls
Repeat
Select WaitEvent
Case $20
WLocate 100,18:Print a$(GadgetHit) ;print silly message
MoveWindow_ win,Rnd(200)-100,Rnd(200)-100 ;call system routine
Case $200:End ;end if close gadget
End Select
Forever
Data$ "0000M","Button 1","PA PA","Button 2","BANG!","Button 3"
    
```

The sliders that you are use to on the Amiga are also known as Proportional Gadgets. In Blitz 2 there are a number of commands to both control prop gadgets and read their settings. The following descriptions use the terms body and pot, pot refers to the position of the slider bar in the gadget, the body refers to its size.

SetVProp & SetHProp are used to configure both the sliders pot and body
VPropPot & HPropPot return the sliders current vertical & horizontal position
VPropBody & HPropBody return the sliders current size
Redraw should be used after using the SetVProp and SetHProp commands
Back to the Editor

I won't go into too much detail about how the editor all fits together. I have included lots of comments throughout the listing so that you can get the most from studying them.

The main thing is an explanation of what to do with the editor once it's working! The first thing you should do is Load the map I have placed in the dungeon drawer of the cover disk. Using the Load menu from your new dungeon editor find the MAP1 file I have saved for you. After successfully loading the program you can now scroll round the map using the slider gadgets on the side of the window.

OK, so what do the different letters represent?

- * WALL
- O HOLE (that monsters fall down)
- M MONSTER (oh no)
- B BLITZMAN (thats you of course)

Click on any of the buttons in the ToolBox window, you can then paint on the main window simply by using the left button of the mouse. Simple, huh?

A few rules that I haven't checked for in the program:

- Don't have more than one BlitzMan in the dungeon
- Don't add more than 256 monsters!
- Don't paint on any of the walls that border the main area
- Do be creative!

Next issue I will show you how to use graphics in windows so we can expand the editor for generating "tile" based maps for those seemingly endless scrollers which are still the rage, whether they be platformers or shoot em ups. Make sure you have your graphic artist at hand, you may even need two now that you're programming in Blitz 2!

THE DUNGEON GAME

Welcome to the Dungeon, it's full of fun and games, you seem pretty eager baby, so get down on your knees... Oops, that's enough of that...

Now that we have a dungeon editor we'll need a program that lets us play in them! As I mentioned the listing this month is only a shell to get you

Continued overleaf

```

Return
.sizewindow
Use Window 0
ww=Int(WindowWidth/8)-3 ;num blocks we can display
wh=Int(WindowHeight/8)-3 ;with current window size
Gosub drawdungeon
SetVProp 0,0,posy/height,wh/height ;position sliders
SetHProp 0,1,posx/width,ww/width
Redraw 0,0:Redraw 0,1
Return
.drawdungeon
WindowOutput 0
posx=QLimit(posx,0,width-ww) ;get topleft coordinate with
posy=QLimit(posy,0,height-wh) ;limit of upper/lower value
InnerCls
For y=0 To wh-1
For x=0 To ww-1 ;character based on value in map
ch=map(posx+x,posy+y)
If ch Then WLocate x*8,y*8:Print c$(ch)
Next
Next
Return
.initui
MenuTitle 0,0,"PROJECT" ;set up menus for our editor
MenuItem 0,0,0,0,"LOAD ","L"
MenuItem 0,0,0,1,"SAVE ","S"
    
```

```

MenuItem 0,0,0,2,"QUIT ","Q"
PropGadget 0,-16,10,2+16+128,0,16,-20 ;gadgets for sliders
PropGadget 0,4,-9,4+8+64,1,-22,10
For i=0 To 4 ;gadgets for brush select
TextGadget 1,i*24+12,12,512,2+i,c$(i)
Next
brush=1:Toggle 1,3,On
Screen 0,10,"Dungeon Editor" ;and a screen and windows
Window 0,0,12,640,240,$100f,"DUNGEON",1,2,0:SetMenu 0
Window 1,400,0,140,28,$100f,"BLOCKS",1,2,1:SetMenu 0
Use Window 0:Redraw 0,0:Redraw 0,1
Return
.loadmap
a$=FileRequest$("LOAD DUNGEON",pa$,fi$) ;do a file request
If ReadFile(0,a$) ;if file there
If Lof(0)=size Then ReadMem 0,&map(0,0),size ;read it into map
CloseFile 0 ;array (raw!)
Gosub drawdungeon ;refresh screen
EndIf
Return
.savemap
a$=FileRequest$("SAVE DUNGEON",pa$,fi$)
If WriteFile(0,a$)
WriteMem 0,&map(0,0),size:CloseFile 0 ;write array to file raw
EndIf
Return
    
```

ISOBLASTER V0.1

BY SIMON ARMSTRONG

```
; set up all the main types and arrays
```

```
NEWTYPER .object ;same is IsoRender.bb but with extra fields
  depth,q:ld ;depth and shape id 0=me 1=mozzy
  x:y:z ;3D coordinates of shape
  vx:vy ;velocity in both x and y
  rot:rot2:rotr ;rotation variables
  sx:sy ;screen position after an iso-projection
```

```
End NEWTYPER
```

```
Dim List bob.object(50)
```

```
DEFTYPER .object *me
```

```
Dim qsin(255),qcos(255) ;set up array of sin/cos values so
For r=0 To 255 ;we don't have to call sys ones in game
  qsin(r)=Sin(Pi*r/128):qcos(r)=Cos(Pi*r/128)
Next
```

```
Dim map.w(20,20) ;bit smaller than the dungeon (at present)
```

```
; load all the graphics from disk
```

```
LoadShapes 0,"blocks.shapes" ;tiles for the ground
LoadShapes 4,"balls.shapes" ;balls for fx etc.
LoadPalette 0,"balls.iff" ;palette for foreground playfield
LoadPalette 0,"blocks.iff",8 ;palette for background
LoadShapes 16,"isoshapes" ;shapes rendered by IsoRender.bb
```

```
BitMap 0,320+64,256+80,3 ;foreground A
BitMap 1,320+64,256+80,3 ;foreground B
BitMap 2,640,512,3 ;large scrolling background
```

```
Queue 0,32:Queue 1,32 ;two queues for double buffered blitting
```

```
Macro p 320+(`1-`2)ASL 4,128+(`1+`2-`3)ASL3:End Macro ;back
Macro f 320+32-sx+(`1-`2)ASL4,128+32-sy+(`1+`2-`3)ASL3:End Macro ;front
```

```
; create Blitz Mode display which for this game is
; dual playfield with double buffered foreground!
```

```
BLITZ
```

```
Slice 0,44,320,256,$ffa,6,8,32,320+64,640
```

```
Use Palette 0
```

```
Gosub setupmap ;place a few blocks in the 2D array
Gosub drawmap ;draw map onto large background playfield
Gosub initgame ;initialise objects in the game
```

```
; then of course the standard main loop of any game...
```

```
While Joyb(0)=0
  VWait:ShowF db,32,40,sx:ShowB 2,sx,sy,32 ;position bitmaps in display
  db=1-db:Use BitMap db ;swap buffer for double buffered drawing
  Gosub moveme ;move me
  Gosub movethem ;and them
  UnQueue db:Gosub drawbobs ;then draw everyone in new pos
  ; MOVE#-1,$dff180 ;view frame time!
Wend
```

```
End
```

```
; and now what makes everything work properly!
```

```
.moveme:
```

```
USEPATH *me ;use pointer to my object in list
\rot=QWrap(\rot-Joyx(1)/2,0,16) ;rotate according to joystick
If Joyb(1)=1 ;if fire
  \vx+qsin(\rot ASL 4) ASR 6 ;then thrust in direction I
  \vy+qcos(\rot ASL 4) ASR 6 ;am pointing (my \rot)
EndIf
\vx-\vx ASR 5 ;this subtracts a fraction of my velocity
\vy-\vy ASR 5 ;off my velocity (same as drag)
\x=QLimit(\x+\vx,0,19) ;this adds velocity to my position
\y=QLimit(\y+\vy,0,19)
\sx=!p(\x,\y,\z) ;calculate screen coordinates
sx=QLimit(\sx-160,0,320) ;calculate scroll values for display so
sy=QLimit(\sy-128,0,256) ;I am as close to center as possible
\sx-sx+32:\sy-sy+32
\depth=\x+\y ;don't forget my depth variable
If map(\x,\y)=1 ;oh and colour in block if I stand on one
  Use BitMap 2:x=Int(\x):y=Int(\y):Blit 2,!p(\x,y,0):Use BitMap db
EndIf
Return
```

```
.movethem:
```

```
USEPATH bob() ;simple routine that loops through
ResetList bob() ;all shapes making /id=2 shapes
While NextItem(bob()) ;fly round in circles...
  If \id=2
    \rot=QWrap(\rot+\rotr,0,16)
    \rot2=QWrap(\rot2+1,0,16)
    \x+qsin(\rot ASL 4) ASR 4:\y+qcos(\rot ASL 4) ASR 4
    \sx=!p(\x,\y,\z)
    \depth=\x+\y
  EndIf
Wend
```

```
.drawbobs:
```

```
SortList bob() ;sort from back to front
ResetList bob() ;loop through and draw, if they
USEPATH bob() ;are \id=2 draw propellor as well
While NextItem(bob())
  If RectsHit(\sx,\sy,1,1,16,40,320+31,256+40)
    QBlit db,\id*16+\rot,\sx,\sy
    If \id=2 Then QBlit db,\id*16+16+\rot2,\sx,\sy
  EndIf
Wend
Return
```

```
.initgame:
```

```
ClearList bob()
AddItem bob():*me.object=bob()
*me\id=1,..5,..5,0
For i=0 To 2
  If AddItem(bob())
    bob()\id=2,Rnd(19),Rnd(19):\rotr=(Rnd(1)-.5)ASR 2
  EndIf
Next
Return
```

```
.setupmap:
```

```
For x=0 To 19:For y=0 To 19:map(x,y)=1:Next:Next
For x=9 To 11:For y=9 To 11:map(x,y)=-1:Next:Next
Return
```

```
.drawmap:
```

```
Use BitMap 2
For x=0 To 19
  For y=0 To 19
    If map(x,y)>-1 Then Blit map(x,y,!p(\x,y,0))
  Next
Next
Return
```

Continued overleaf

THE MICRO ADVENTURES OF...

SAM IGG

"...BY THE TIME I REACHED THE SCENE, THE DISCS HAD BEEN 'RUBBED OUT'... THERE WAS ONLY ONE THING TO DO. CALL 'SIREN SOFTWARE' FOR EXTRA BACKUP!"



TELEPHONE
061-724 7572
FAX 061-724 4893

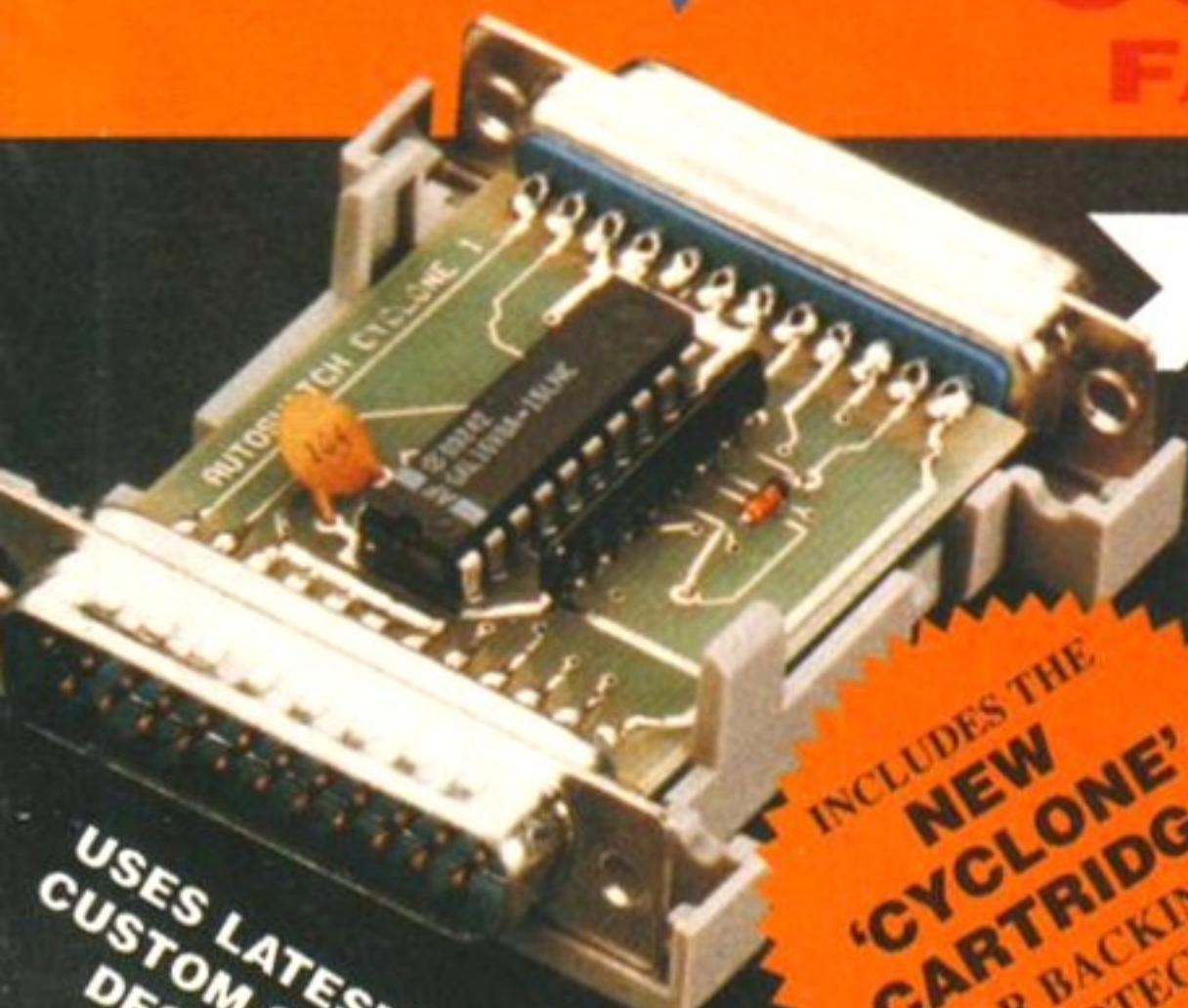

X-BACKUP PRO

X-Backup Pro is the most powerful disc backup utility available for the Amiga, BUT DON'T TAKE OUR WORD FOR IT...

CU Amiga Magazine, July 1993

"IT'S UNBEATABLE."

'a veritable bargain at just £39.99'

Amiga Computing, September 1993

'fast, flexible and reliable'

Amiga Computing, September 1993

£39.99

+ £1 postage & packing

THIS PRODUCT MUST NOT BE USED TO INFRINGE COPYRIGHT.

Unlike other disc backup utilities, X-BACKUP PRO is totally automatic and extremely simple to use. It is fully compatible with ALL AMIGA computers.

- Will backup virtually any disc onto another disc.
- Full hard disc backup.
- File management facility.
- Optimise, formats, repairs, verifies.
- Includes the 'AUTOSWITCH' CYCLONE cartridge. Simply plugs into the external disc drive socket at the rear of the Amiga, and plug your external disc drive into the back of the CYCLONE cartridge for unbeatable disc backup power. An external disc drive is required for use with the CYCLONE cartridge. These are available from us priced £54.99.

FULL MONEY BACK GUARANTEE.

If you can find a more powerful disc backup utility, we will give you your money back.

USES LATEST CUSTOM CHIP DESIGN

INCLUDES THE NEW 'CYCLONE' CARTRIDGE FOR BACKING UP PROTECTED SOFTWARE



A1200 4mb memory expansion with clock 32 bit wide auto configuring Fastram. Zero wait state allows the A1200 to run at full speed. Increase the speed of the computer by 219%. Battery backed clock keeps the correct time and date even when the A1200 is switched off.

Simple trapdoor installation.

£159.99

SPECIAL OFFER

Deluxe disc drives

Whisper quiet. Slimline design. Suits any Amiga. Cooling vents. Sleek, high quality metal casing. Quality Sony/Citizen drive mechanism. On/Off switch and throughport at the rear of the drive. Full 880K capacity. Long reach connection cable.

CYCLONE COMPATIBLE

£54.99



HARD DISC DRIVES

85mb **£189.99**
120mb **£289.99**
A1200 with 85mb hard disc drive fitted **£489.99**
A1200 with 120mb hard drive fitted **£589.99**
Our 2.5" hard drives for the A600/A1200 offer speedy access times and come complete with fitting cable, screws and full instructions. They are preformatted and have Workbench installed for immediate use. Fully guaranteed for 12 months.
Fitting service available for £25.00.
Please phone **061 724 7572** for further details.

SUPERB VALUE FOR MONEY



Soundblaster

The SOUNDBLASTER is a 10 watt stereo amplifier that comes complete with high quality 3 way speakers, power supply and FREE STEREO HEADPHONES! The SOUNDBLASTER adds a new dimension to games playing, imagine stunning stereo sound effects, crystal clear samples and terrific stereo tunes. The SOUNDBLASTER also boosts games playability! The speakers are powerful 50 watt 3 way units featuring a 3" woofer, 2" honker and a 1" tweeter to provide a powerful crisp sound.

£44.99

IMPROVED SOUND QUALITY



Order **NOW** for immediate despatch
Tel. 061 724 7572 Fax 061 724 4893

Telesales open 9am - 6pm Monday-Friday

Access/Visa accepted

Send a cheque/Postal order or credit card details to:-

Siren Software, Wilton House, Bury Rd, Radcliffe, Manchester M26 9UR England

Government, Education and PLC orders welcome.

All prices include VAT at the current rate. Postage and packing will be charged at £3.50 per order (U.K.), £7.50 Europe, £12.50 rest of world.

Please note that 5 working days must be allowed for cheque clearance. Immediate clearance on Building society cheque or Bank Draft.



SIREN SOFTWARE

Wilton House,
Bury Rd,
Radcliffe,
Manchester
M26 9UR
England

WE'VE GOT WHAT YOU NEED

LETHAL WEAPON



More guts... More power... More fun.

Get to grips with these new game controllers from SAITEK, world leader in intelligent games. Serious stuff!

4 designs, 14 models. Auto-fire, turbo speed/volume control, slow motion, turbo fire buttons, multi-directional control pads, and more.

For the ultimate power in your games get SAITEK.

Check'em out at your games shop today!

MX220 MEGAGRIP II
for Sega (8-bit) Atari, Commodore,
Amstrad and Compatibles.

MX120 MEGASTICK II
for Sega (8-bit) Atari, Commodore,
Amstrad and Compatibles.



 **Saitek**™

PUT THE POWER IN YOUR HANDS.

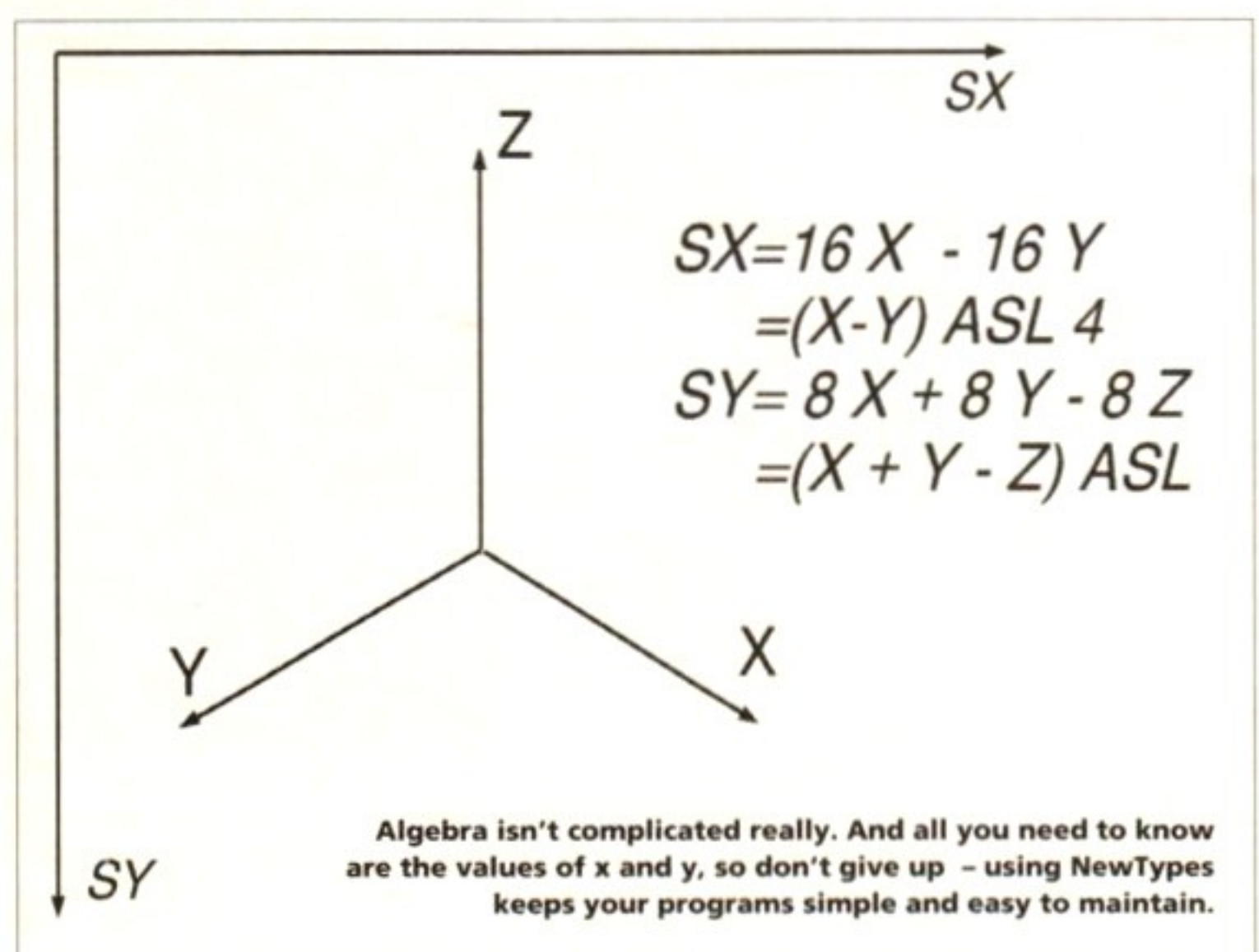

THE SLICE COMMAND

To set up a dual playfield slice we use the long (10 parameter!) version of the slice command, its syntax is:

Slice
 Slice#,Y,Width,Height,Flags,BitPlanes,Sprites,Colours,Width1,Width2

- SLICE # - the display can be made up of multiple slices
- Y - 44 is the standard vertical position that displays should start
- WIDTH - actual width of display (can be smaller than the bitmaps to be shown)
- HEIGHT - 256 is standard PAL height
- FLAGS - \$fff8=lores \$fff9=hires \$fffa=dualplayfield
- BITPLANES - Number of bitplanes in total to be displayed
- SPRITES - Always set to 8 (even when not used)
- COLOURS - Number of colours
- WIDTH1 - Foreground Bitmap width
- WIDTH2 - Background Bitmap width (same as Width1 if not Dual Playfield)

When utilising a dualplayfield display we use the ShowF and ShowB commands to position our two bitmaps on the display.

started, it's up to you to turn it into something fun and addictive. Don't be put off because it just uses boring text and doesn't have snazzy graphics. That sort of attitude is responsible for some of the worst Amiga programs around. This project is aimed at getting you into a creative mode without being slowed down by the glamour 'tude.

First up a little bit of detail. The dungeon program loads in maps created by the dungeon editor, and lets the player (the B character) move round by typing L, R, U or D and then return. At the moment, you can't walk into walls and neither can the monsters (they're the big M's) but you can fall down holes as can the monsters. Yup, you guessed it, the game ends when you've tricked all the monsters into falling down holes rather than eating you up!

To turn the listing into something even more playable (gasp!) it's time for some more technical stuff...

Two major features we have added to Blitz 2 are NewTypes and LinkedLists. The dungeon game is a very simple introduction to both, as information about each monster is held in a NewType and all the monsters are stored in a Linked List!

NEWTYPES

Similar to the fields of a database or structures in C, Blitz 2 NewTypes are designed to contain a collection of data in one variable or record. Say we have a ball in our program that has both an x and y value as well as a height. In standard BASIC we would assign the ball three variables:



Using the Iso-render program (see next page) you can create shapes made up of different balls connected together.

```
ballx=20:bally=30:ballheight=50

If we had 50 balls we would need 3 arrays:

Dim ballx(50),bally(50),ballheight(50)
```

By defining a NewType that can hold not one, but three values:

```
NEWTYP object
  x:y:height
End NEWTYPE
```

We then only need one variable for our ball:

```
ball.object\x=20,30,50
```

Or if we have 50 balls we only require a single array:

```
Dim ball.object(50)
```

Using NewTypes not only keeps your programs simpler but much easier to maintain. If we need to add more fields for say, the ball's size we just add a size field to the NEWTYPE definition, no need to dimension another array!

LINKEDLISTS

A standard array in BASIC holds a fixed number of items. Often an array may be dimensioned to hold say 50 items, but at any one time the program may only have 20 items stored in the array. Separate variables are required to keep track of how many items are held in the array and several commands are needed to add a new item to the array and even more to delete one.

In Blitz 2 the linked list means these hassles are a thing of the past. The following creates a linklist structure that can hold a maximum of 50 balls:

```
Dim List ball.object(50)
```

The "list pointer" referred to in the following description is an internal pointer that replaces the index required by standard arrays. This internal pointer means we no longer use an index so:

```
ball(n)\x=20 ;using standard array where n is the array index
```

is replaced by:

```
ball()\x=20 ;no index required as the list has an internal index pointer
```

To add a new ball to our list we replace:

```
If n<50 Then n=n+1:ball(n)\x=10,30,50
```

Continued overleaf

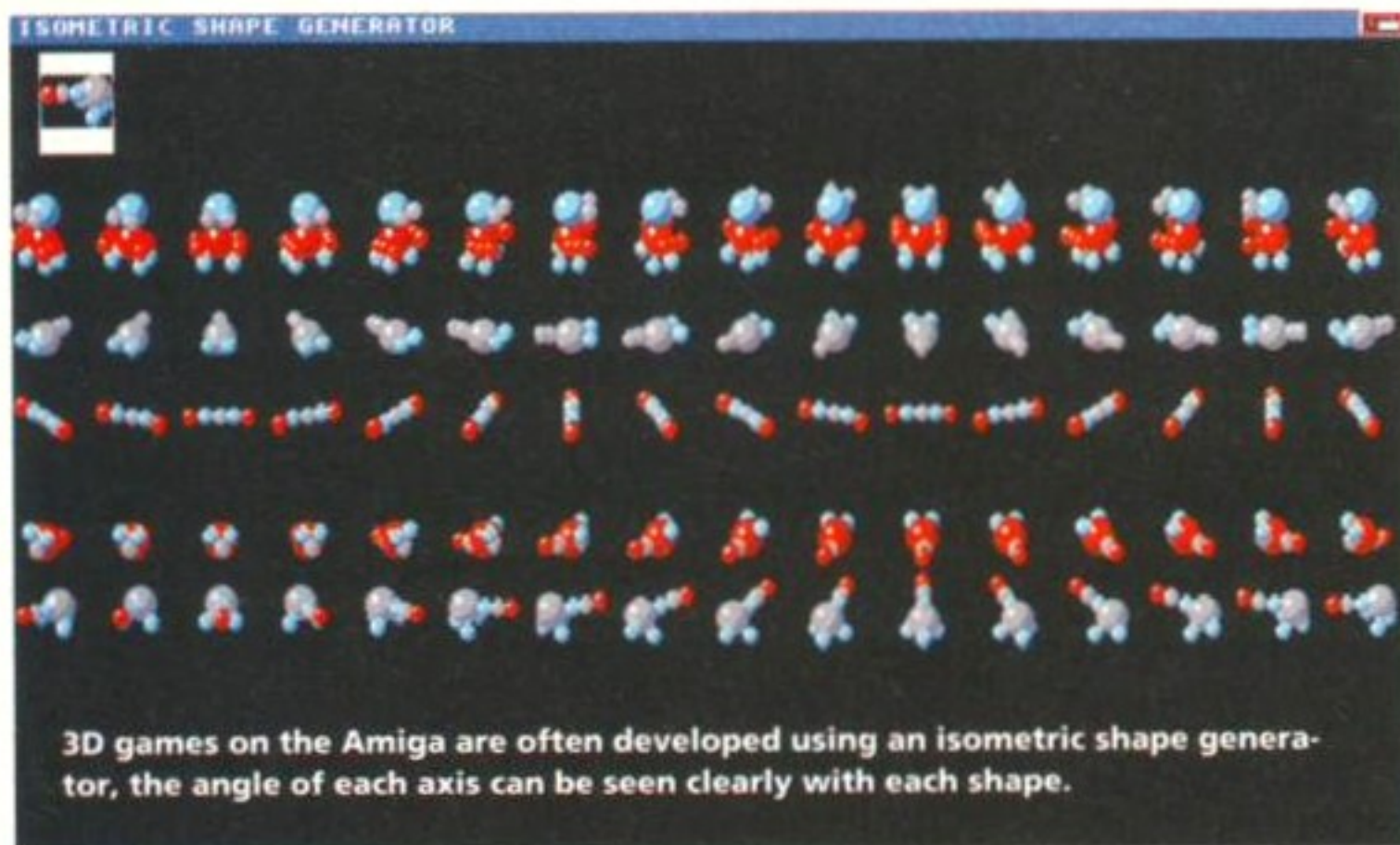

3D games on the Amiga are often developed using an isometric shape generator, the angle of each axis can be seen clearly with each shape.

with the AddItem command which returns false if the List is full:

```
If AddItem(ball()) Then ball()\x=10,30,50
```

A typical loop to move all the balls in a list looks like:

```
ResetList ball()           ;reset internal pointer back to head of list
While NextItem(ball())    ;loop through list until we get to the end
ball()\x+10                ;move "current" ball right
Wend
```

The NextItem() command moves the internal pointer on to the next item, returning false if there is none. LinkedLists produce not only tidy code but fast code, faster than normal arrays using standard indexes. And just to prove just how cool Linked Lists are we can add or delete items from a list in one command! We could add the following line to the inside of the previous loop:

```
If ball()\x>300 Then KillItem ball() ;try that in normal BASIC!
```

BACK TO THE DUNGEON!

If you grasped all that you are doing extremely well. If you didn't don't worry, go ahead and type in the dungeon listing. The remarks are there so you can get just as much out of reading through the listings as studying this tutorial.

As I mentioned earlier, we will be expanding the map editor to handle graphics next issue. With this in mind you may want to start designing the graphics to replace the M*BO graphics, anim brushes will be fine but keep things small. The graphic version of dungeons will use shapes about 16 x 16 and of course be real time, none of this hitting return after every move!

The nice thing about the next version is it will still use Intuition and hence multitask with the rest of your system, unlike our next project...

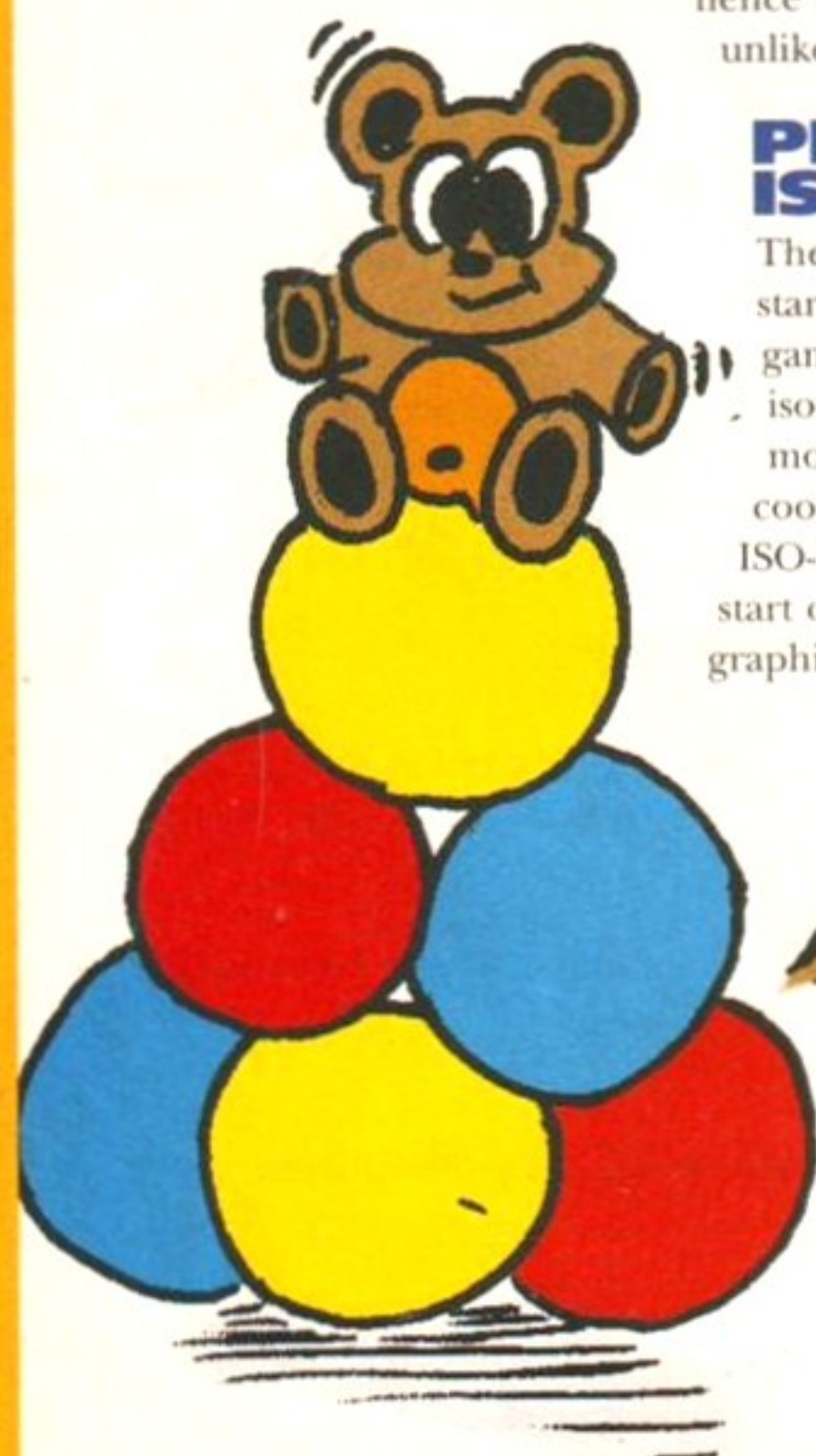

PROJECT 2 - ISO-BLASTER

There are two listings this month to get us started on our very own original arcade game. Listing 1 - ISO-Render - creates isometric shapes out of what are commonly known as vector balls (after a very cool demo some years back), Listing 2 - ISO-Blaster - is the actual game (well the start of a game). Both programs require the graphics files which I have placed in the



ISOBLASTER drawer of the Coverdisk. You must have ISO-Render running before you can run ISO-Blaster because ISO-Render creates the shapes file that ISO-Blaster requires.

So, who's Isometric? Isometric is a common perspective for developing 3D games on the Amiga. The diagram on the left shows the angle of each of the three axis in our game. Using an isometric perspective is very fast compared to a proper 3D view, there is no vanishing point and so shapes don't get larger and smaller depending on their position which means we can "pre-render" all our shapes.

The ASL command is an "Arithmetic Shift Left", those that know their binary logic will know that shifting a number to the left is the same as multiplying it by 2. The ASL 3 and ASL 4 in the above functions are quick replacements for *8 and *16.



This screenshot of the balls shows their codes so you can create some extra shapes for the game.

The ISO-RENDER program listed is used to render 16 rotations of each of our shapes. Each of the shapes is made up of balls connected together, the data tables at the end contain the number of balls in total and then the ball, x, y, z information. The following is a screenshot of the balls and their relative codes so you can create some extra shapes for the game.

As we are rotating a shape around its Z axis we use the following matrix multiplication:

$$\begin{bmatrix} x \\ y \end{bmatrix} * \begin{bmatrix} \sin\theta & \cos\theta \\ \cos\theta & -\sin\theta \end{bmatrix} \Rightarrow (x * \sin\theta + y * \cos\theta, x * \cos\theta - y * \sin\theta)$$

If you slept through maths that day it might be wise to ask someone a little more attentive to explain matrix multiplication to you. Using the above function we can rotate all the balls in the shape around the z (vertical) axis any degree we like.

However like other BASICs we have to remember the Sin() and Cos() functions in Blitz 2 work with radians:

A full rotation (360 degrees) is equal to 2*pi radians, so to rotate our shapes through 16 rotations we accomplish this in steps of pi/8 radians (360/16 degrees).

To Render each rotation of each shape we use the following steps:

- Loop through 16 rotations in steps of pi/8 radians
- Loop through all the balls in the shape
- Read in their x,y,z offset (3d position)
- Rotate this position around the current rotation value
- Calculate the balls' depth so we can sort them from far to near
- Sort the balls
- Loop through the balls in the sorted order and draw them into the frame
- Next Rotation

THE ISO-RENDER DISPLAY

As it is useful to see all the shapes we generate on the screen at once, ISORender opens a nice big hi-res interlace screen. We can use Blitz Basic's fast Blit commands with an Intuition Screen with the help of the ScreensBitmap command. After using this command Blitz 2 enables us to Blit to the Screen just as though it was one of our own bitmaps.

The following is a brief explanation of some new commands used in the ISO-RENDER listing:

- LoadShape** - can load any IFF or BlitzType graphics file into a shape object
- LoadShapes** - can load a series of shapes from an IFF AnimBrush or BlitzType file
- LoadPalette** - reads colours from an IFF file into a Palette object
- SaveShapes** - write shapes to BlitzType graphics file format
- Box/BoxF** - for drawing rectangles onto a BitMap
- Blit** - copy shape to a bitmap using the Amiga's Blitter
- BlitColl** - pretend to blit shape to deduce if bitmap is blank underneath
- GetAShape** - copy data from bitmap to a shape object
- Handle** - position the handle (origin) of a shape
- VWait** - Wait so many frames (50th secs)
- Restore/Read** - standard BASIC commands to handle DATA

Continued overleaf

Natural breadth

To have real breadth in our printer product range seems natural to the world's second largest computer manufacturer. Our wide range is your safety.

For further information please contact your local distributor
Dynamic Distribution,
Tel. 0293-547788, Fax 0293-613932.
Technology PLC,
Tel. 0925-830404, Fax 0925-830040.
Zygal Dynamics PLC,
Tel. 0869-253361, Fax 0869-249061 or
Fujitsu Printer Products of Europe,
Tel 081-573-4444,
Fax 081-813-7371 directly.

Silent inkjet printers with a speed of up to 360 cps. Professional laser printers. Matrix printers for all needs. Light laptop/notebook printer. Line printers for large capacity printing.

For the fiscal year 1992, the consolidated turnover of Fujitsu was more than £ 19.900 million of which more than £ 2.200 million was devoted for product research and development.

Fujitsu – always a safe choice.

FUJITSU

COMPUTERS, COMMUNICATIONS, MICROELECTRONICS

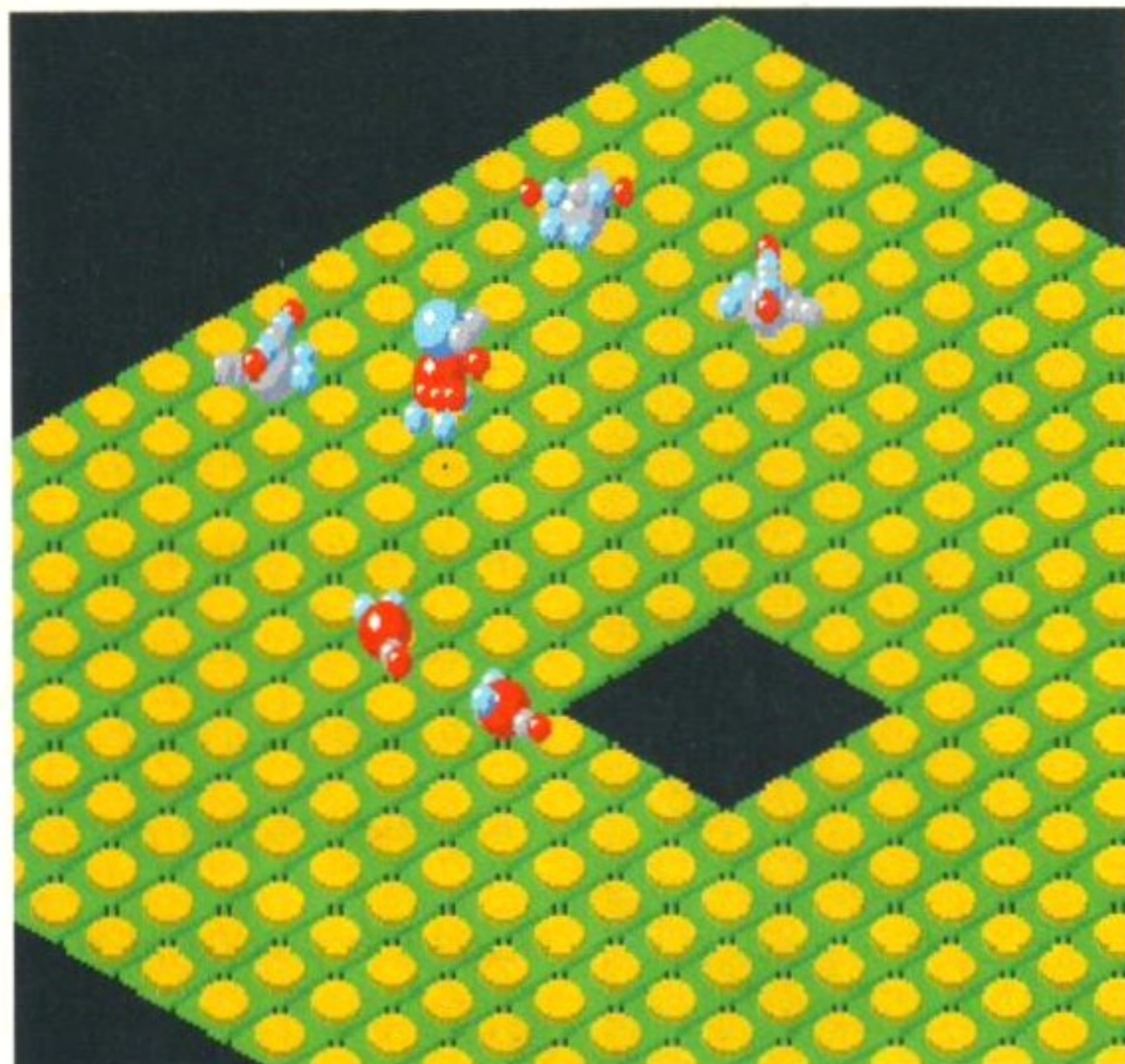

This is what the ISO-Blaster game will look like when you type it in and run it. It's far from a finished game, featuring only a nice background and some Heli-bees...

Don't forget about the HELP key in Ted to find out the exact syntax for these commands when you're typing in the program and getting familiar with everything.

What you may want to do is come up with some new shapes for our ISO-Blaster game, we're going to need lots of them! Send in the data tables of any you think we should use in the final game.

To add a new shape just copy the last Restore datalabel... line to the next line and change the f=48+r to f=64+r and make the Restore position the DATA pointer to your new shape's data. Then change the y offset of the Blit to further down the Screen. The new line of code should now read:

```
Restore cannon:f=64+r:Gosub makeframe:Blit f,r*32+16,224
```

You might want to try the following as data for your new shape:

ISORENDER.BB BY SIMON ARMSTRONG

```
NEWTYPED .balltype ;all fields are .q (fast 32 bit fixed decimal point)
  depth,q ;used for sorting list of balls from back to front
  col ;color of ball (see table)
  x:y:z ;3D position of ball
  sx:sy ;screen position of ball after iso-projection
End NEWTYPE
```

```
Dim List ball.balltype(50)
```

```
LoadShapes 4,"balls.shapes" ;make sure we're in iso drawer (use CD)
LoadPalette 0,"balls.iff" ;get palette from IFF
```

```
Screen 0,27,"ISOMETRIC SHAPE GENERATOR" ;open hires lace screen
Use Palette 0
ScreensBitMap 0,0
```

```
Box 15,15,15+33,15+41,1 ;shape must fit inside this frame
GetaShape 0,16,15,32,1 ;for clipping height
```

```
For r=0 To 15
  Restore myshape:f=16+r:Gosub makeframe:Blit f,r*40+16,104
  Restore mozy:f=32+r:Gosub makeframe:Blit f,r*40+16,144
  Restore blade:f=48+r:Gosub makeframe:Blit f,r*40+16,184
Next
```

```
.cannon
Data 7
Data 8,-.22,.3,1
Data 8,-.22,-.3,1
Data 7,-.6,0,1
Data 4,-.4,0,1.8
Data 8,0,0,1.9
Data 7,.3,0,2.1
Data 9,.6,0,2.3
```

And now, on with the game!

ISO BLASTER

The game at the moment is I suppose a mix of Atari's *Crystal Castles* and *Asteroids* however it's not going to stay that way for long! At present, the ground is made up of tiles and you are able to rotate and accelerate in any direction you wish. A few heli-bees circle round the place and generally everything is peaceful.

Next month, we will add some ammo and work on a routine to explode the shapes back into separate parts. If we get enough space we'll add a map editor and introduce some height into the game so gravity starts playing its part. However the important thing this month is to get to grips with Blitz mode and how we can set up our own display.

DISPLAY BASICS

Blitz 2 has two modes known as Amiga-Mode and Blitz-Mode. All the code we have covered so far has been running in AmigaMode and we have been able to utilise the operating system's Screens and Windows for our display needs.

Now, however it is time to forget about the operating system and switch to Blitz mode. The primary difference is that we no longer have access to Screens and Windows, instead we have to display our graphics using what is known as Slices.

The following code sets up a bitmap (display memory) and displays it on a standard slice:

```
BLITZ ;turn off OS (we're on our own now!)
BitMap 0,320,256,3 ;8 colour lores bitmap
Slice 0,44,3 ;a standard 8 color slice
Show 0 ;display bitmap 0 on our slice
Boxf 0,0,100,100,1 ;draw a box
MouseWait ;wait for mouse click
```

There are some important rules that govern what you can do while your program is in BlitzMode:

```
SaveShapes 16,f,"isoshapes" ;save all shapes generated
MouseWait
End
```

```
; the following routine reads the balls from data into a
; list, rotates them around the z axis, sorts, projects,
; draws, clips and finally grabs them by the tail!
```

```
.makeframe:
  Read n ;how many balls follow?
  rsin=Sin(r*Pi/8) ;needed for the 2D rotation that follows
  rcos=Cos(r*Pi/8)
  ClearList ball() ;empty our work list of all items
  USEPATH ball() ;save typing ball() 50 times!
```

```
For b=0 To n-1
  AddItem ball() ;read ball into the list array
  Read \col,tx,ty,\z
  \x=tx*rsin+ty*rcos ;rotate it through a 2D matrix
  \y=tx*rcos-ty*rsin
  \depth=\x+y ;calculate depth for sorting
Next
```

```
Boxf 16,16,16+31,16+39,0 ;clear frame for drawing into
SortList ball() ;sort from back to front
ResetList ball() ;start with back ball
While NextItem(ball())
```

- NO FILE ACCESS
- NO WINDOWS, SCREENS, GADGET COMMANDS
- NO MULTITASKING

Ouch! OK so Blitz mode is a serious state to be in! The benefits are, of course, more speed and total control of the Amiga's custom chip set including every display trick in the book. The two main display tricks we need to cover this month are dualplayfield and double buffering.

DUALPLAYFIELD

On a standard Amiga the display hardware is capable of displaying 2 bitmaps at the same time, one in front of the other. The limitation is that each bitplane can only contain eight colours, AGA has increased this to 16. The benefits of DualPlayfield are the ability to scroll (move) each bitmap separately and the speed increase of not having to worry about the background graphics when drawing the fore-ground action (because they are on different bitmaps).

DOUBLE BUFFERING

One of the main criteria in programming any sort of moving graphics on a computer is that the display does not flicker or glitch. A main cause of this is when the bitmap that is being displayed on the monitor is also being redrawn by the computer. To avoid this problem two bitmaps are required, one for display and one to be updated with the next frames information.

Once the next frame is ready the two bitmaps swap jobs and the first one is now updated and the second one displayed. This alternating of bitmaps is known as double-buffering.

The following code is a very simple demonstration of a double buffered display:

```

BLITZ
BitMap 0,320,256,3           ;two identical bitmaps
BitMap 1,320,256,3
Slice 0,44,3                 ;standard slice
While Joyb(0)=0             ;while no mouseclick
  VWait                       ;wait for top of frame
  Show db:db=1-db:Use BitMap db ;show 1 bitmap and use the other
  Cls:Circlef 160,128,r,1:r=QWrap(r+4,10,200) ;draw new circle

```

WendIf you remove the VWait the double buffering will no longer be synched with the display and the animation ceases to be smooth and glitch free.

QBLITS

The next thing that needs mentioning is the use of Blitz 2's queue system. One method of moving shapes around the screen is to clear the entire bitmap before blitting the shapes in their new position.

An alternative is to remember where all the shapes were in the last frame and clear only those parts of the bitmap when it comes time to redraw them in their new positions. This is what Blitz 2 queues will do, each time you QBlit a shape to a bitmap the position is stored in a "queue". When it comes time to redraw the bitmap with new shapes/positions the Unqueue command replaces the CLS command to quickly clear the bitmap of the old shapes.

And back to ISO-Blaster v0.1

Now that we know about displays and queues we're ready to get on with the game. There are a few concepts in ISO-Blaster that I will not cover in detail this month. They include the use of Macros and pointer variables and the UsePath directive. Just quickly:

WHAT'S IN STORE FOR FUTURE ISSUES

MACRO: a group of commands defined in a macro can be repeated through your program by using !macroname. Any parameters in curly brackets are inserted into the macro expansion at locations marked by `n where n is a parameter number.

POINTERTYPES: a variable preceded by an asterisk is known as a pointer, it contains the location of a variable not the actual variable itself. In Blitz 2 pointers are most useful for referencing particular items in a list.

USEPATH: any variable name listed after UsePath will be inserted before variables referenced by an initial backslash by Blitz 2 at compile time.

The rest of the game? Well we've run out of space. As I mentioned earlier I have put a number of comments in the actual listings themselves and made them as structured as possible. This means that you will hopefully have no problems reading through and learning from them. The only way to get to know a new language such as Blitz 2 is by immersing yourself in it, soon you'll be reading the listings as if they were in English, well that's what BASIC is all about!

```

  \sx=32+(x-y) ASL 4           ;calculate screen position
  \sy=48+(x+y-z) ASL 3
  Blit \col,x+\sx,y+\sy       ;and draw to screen
Wend

;the following clips the rendered shape so that smallest
;possible area is fetched for the destination shape

y0=16:While BlitColl(0,16,y0)=0:Blit 0,16,y0:y0+1:Wend
y1=16+39:While BlitColl(0,16,y1)=0:Blit 0,16,y1:y1-1:Wend
GetaShape f,16,y0,32,y1-y0+1
Handle f,16,36+16-y0
Return

; shape data follows, feel free to experiment, just don't
; use numbers bigger than 2 for the xyz coordinates!
; format is
;   numballs
;   shape#,x,y,z
;   shape#,x,y,z etc.

.myshape:
Data 14
Data 8,-2,-3,0               ;feet
Data 8,-2,0,3,0
Data 8,0,2,-3,0
Data 8,0,2,0,3,0
Data 6,0,0,1                 ;body

```

```

Data 5,0,0,2,5               ;head
Data 7,.4,-.2,2,5           ;eyes
Data 7,.4,0,2,2,5
Data 9,0,-.4,1               ;arms
Data 9,0,0,4,1
Data 9,.2,-.4,1
Data 9,.2,0,4,1
Data 9,.4,-.4,1
Data 9,.4,0,4,1

.mozy
Data 5
Data 4,0,0,1                 ;body
Data 7,-.4,0,1
Data 7,-.6,0,1
Data 8,.4,.2,1
Data 8,.4,-.2,1

.blade
Data 5
Data 9,0,-.6,1,8
Data 8,0,-.3,1,8
Data 7,0,0,1,8
Data 8,0,.3,1,8
Data 9,0,.6,1,8

```

Another great offer from a manufacturer you can trust



*Price includes VAT and delivery

- High quality
- Renowned and proven reliability
- Styled plastic case
- Low power consumption
- Throughport facility for addition of further drives
- Suits any Amiga

Order with Confidence

- ✓ All Cumana products carry our 30 day money back guarantee
- ✓ All products carry our 12 month warranty
- ✓ All inclusive price

NAME _____ ADDRESS _____

POSTCODE _____ TELEPHONE NO. _____

I would like to order CAX354 Disk Drive(s) at £49.95 each

Please debit my ACCESS/VISA card (please delete);

Number _____ Expiry date of card ____ / ____

Signature _____

Cheques should be made payable to Cumana Limited.
Orders may be placed by telephone - 0483 503121, or by fax -
0483 451371, or sent to - Cumana CAX 354 Offer,
Pines Trading Estate, Broad Street, Guildford, Surrey GU3 3BH.

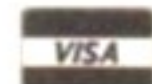

**Manufacturers of
quality products
since 1979**

Cumana reserve the right to increase the price at any time. This offer is subject to availability.

GETTING STARTED DISK 52A



Switch on your machine, and insert Coverdisk 52a. After a few seconds, Workbench will load. Double-click on the icon marked Coverdisk52a, and then double-click on the program of your choice. If you wish to use *Blitz Basic*, please refer to the *Blitz* section (starting on Page 7) for details on how to expand the *Blitz* disk.

DISK 52B



To load the *Overdrive* demo, simply switch on your machine and insert Coverdisk 52b. To load *Amiganoid* or *Megaworm*, or to access the *Mega-Lo-Mania* fix, you'll need to load Workbench first then put the Coverdisk in.

AGA FIXES

We've arranged specially for your games to be tweaked so that they work on the new A1200 wondermachine.



Jimmy White's Whirlwind Snooker is one of five games you will now be able to play on an A1200.

Spread across both Coverdisks you'll find a number of fixes to load five games onto your A1200. These are *Powermonger*, *Powermonger WW1*, *Jimmy White's Whirlwind Snooker*, *Mega-Lo-Mania* and *R-Type*. *Mega-Lo-Mania* fix can be found on Coverdisk 52a, the others on 52b.

Double-click on the fix you require, then when it has loaded take out the Coverdisk and insert disk one of the game. It should then load itself up as usual, and run happily on your A1200. Note: The fixes will only work with original copies of the games.

COVER DISKS

We have a plethora of games and utilities for you on this month's floppytastic Coverdisks. Let Andy Nuttall show you how to get at them.

OVERDRIVE

Time to burn rubber! Climb in the cockpit of Team 17's race driving demo...



In theory the idea is to stay on the actual racetrack, not take a tour through the surrounding countryside.



That's better. Two cars, both on the track. Do your best to get to pick-ups like this Turbo before the other guy.

TOP-DOWN RACING GAMES are two-a-penny, which makes *Overdrive* seem like an odd choice for an addition to Team 17's impressive range of Amiga software. Written as an arcade-style version of the classic *Super Sprint*, Team 17 have concentrated on making *Overdrive* as playable as possible, with fast 50Hz scrolling, and realistic acceleration on the cars.

Our demo of *Overdrive* pits you against two other drivers in eight laps around a single circuit.

Your car's easy to control - press fire to accelerate, and push left and right to steer. The on-screen drivers at Team 17 boast a fastest lap time of 00:12:39 seconds, so see if you can beat that!

MANSELL-TYPE TIP

Your car is pretty responsive, which you can use to keep your speed up through bends: so long as you drop off the accelerator coming around a corner, you'll be able to slide around the bend.

THINGS THAT YOU WANT TO RUN OVER...



CASH - Not much use on this demo of *Overdrive*, but will come into play in the full game.



STEERING - Steering wheels help you take corners, by giving you extra grip on the road.



WHEEL - Picking up wheels will give you some vital extra grip through the patch of oil.



FUEL - Like cash, doesn't do anything in the demo - but it makes a nice diversion.



MARKINGS - Keep an eye out for road markings - don't just use the map at the bottom of the screen.



TURBOS - Drive on these to put your car in top gear, so you can really shift. The effect lasts a couple of seconds.



OIL - Watch out for the dirty great 'orrible oil patch, because it will make your car slide about in uncontrollable fashion. Try to drive through it in a straight line - and remember that picking up extra Wheels will help you get through it safely.

DEFENDER

Play Acid Software's amazing action-packed version of the arcade classic, have a ball and also find out what can be done using Blitz Basic!

DEFENDER

PROTECT HUMANIDS (♣) FROM INVADING LANDERS (☸). LANDERS WILL ATTEMPT TO STEAL HUMANIDS IN ORDER TO MUTATE INTO DANGEROUS MUTANTS (☹). WHEN ALL 10 HUMANIDS ARE LOST, YOU MUST FACE THE HAZARDOUS ENVIRONMENT OF HYPERSPACE! HUMANIDS ARE REPLENISHED EVERY 5 WAVES. PODS (♦) RELEASE DEADLY SWARMERS (▲) WHEN DESTROYED. BOMBERS (☐) RELEASE MINES (×) WHICH MUST BE AVOIDED. BRITERS (☞) APPEAR IF YOU TAKE TOO LONG TO COMPLETE AN ATTACK WAVE.

There's not much point in me writing instructions for *Defender*, because Acid have done it for you already! The screen above appears just before you begin a game, and we've included it here as well in case you get stuck.

DEFENDER'S ONE OF those classics: a game which was born in the early days of amusement arcades, a game with unimpressive graphics, but distinctive sound effects and with gameplay so good that... err... people are still talking about it ten years on. ("They don't make them like they used to," etc.)

Acid Software have taken the original Williams arcade machine, squashed it down and stuffed it inside your Amiga. At least, that's what it looks like

after you've loaded it up. The one thing you might notice if you're a real *Defender* expert is that the laser fire is slightly different, but apart from that it's absolutely identical (right down to the samples taken directly from the arcade machine).

Defender was one of a generation of top-class machines from Williams, so we'll just take this opportunity to mention again that its contemporary *Robotron* is available as Jeff Minter's Shareware classic *Llamatron* (all good PD libraries).

COMMANDS

- F1 Select 1 player mode
- F2 Select 2 player mode
- F3 Toggle keyboard/joystick control for player 1
- F4 Toggle keyboard/joystick control for player 2

CONTROLLING YOUR DEFENDER

MOVE	KEYBOARD	JOYSTICK
UP	A	UP
DOWN	Z	DOWN
LEFT	-	LEFT
RIGHT	-	RIGHT
REVERSE	SPACE BAR	-
THRUST	/	-
FIRE	RIGHT SHIFT	FIRE BUTTON
SMART BOMB	RETURN	RETURN



The nasty aliens will try to kidnap your little chaps. Shoot the baddies to release the captives.



Fail to rescue your humans and they will be turned into mutants like the pinky-green chap on the right.

MEGA WORM

Another temptingly simple game offering courtesy of Kirk D'Souza...

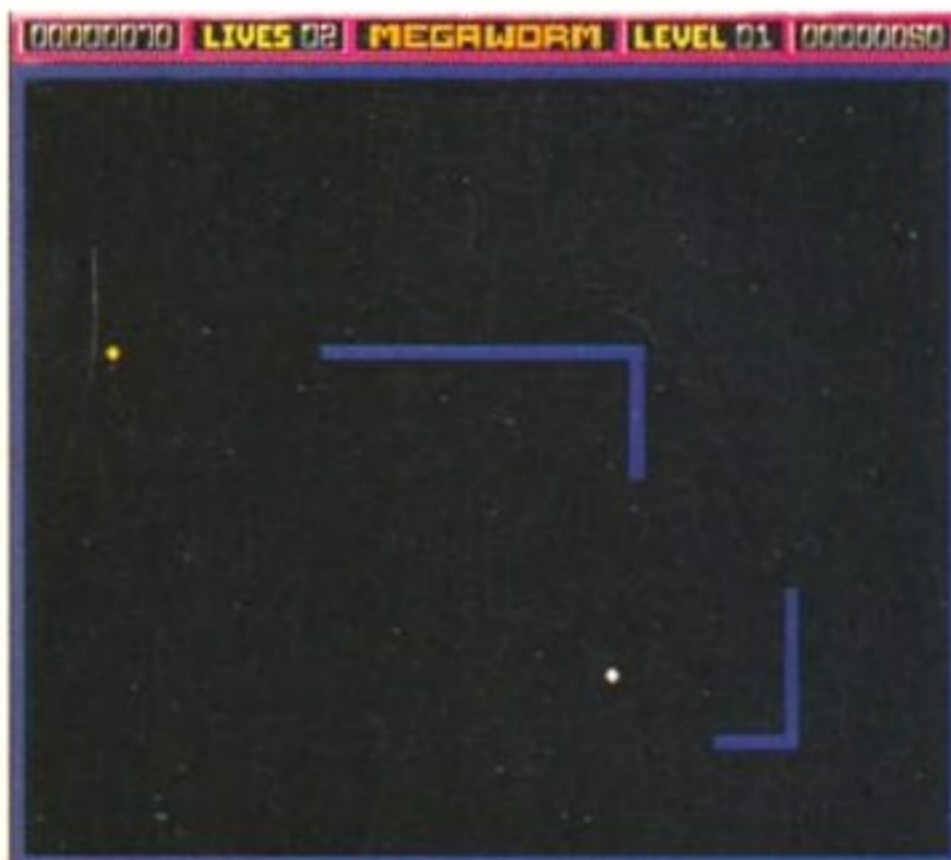

Anyone remember the silly 8-bit game *Caterpillar*? Well, this isn't at all like it. Looks crap, plays great.

THE OBJECT OF this neat little game is to collect randomly placed white pills by moving your worm around. Sounds easy? Well, add to this that you can't crash into the walls, your body or another worm, and it gets more difficult.

There are ten pills per level, each of which increase the length of your worm. There are fifty levels ranging from very easy (Level 1) to virtually impossible (Level 50).

Some pills are coloured, and have the following effects:

- Light Green** Increases speed for 10 seconds.
- Dark Green** Decreases speed for 10 seconds.
- Purple** Doubles the length of your worm, and gives you extra points.
- Pink** Halves the length of your worm.
- Red** New Life.

CONTROLS

DIRECTION	PLAYER 1	PLAYER 2
UP	G	Up arrow
DOWN	V	Down arrow
RIGHT	X	Right arrow
LEFT	Z	Left arrow
S	Turns the stars in the background on/off.	
F	Turns the filter on/off	
P	Pauses the game	
Esc	Quit	

- Orange** You get points just for moving for 10 seconds.
- Blue** Turns all worms on the screen blue for 10 seconds.
- Light Blue** Invulnerability for 10 seconds. Enables you to travel through all blue walls including sides of screen.
- Yellow** Reverses the controls of the other player for ten seconds.
- Grey** Puts out the lights for 20 seconds.

NOTE: Remember to unplug the mouse before using keys for player two.

AMIGANOID

If you've never played a Breakout-style game, you're in for quite a treat thanks to Digital Illusions.



Amiganoid

CLICD HOUR

Based on the second computer game ever made, *BreakOut*, which dates from 1974.



BreakOut games enjoyed a revival in 1987, and here's a new twist to the idea.

FROM THE MAKERS of the already-classic *Pinball Dreams* and *Pinball Fantasies*, *Amiganoid* is described as: "a game which is so simple it needs no instructions." They're probably right, because this game is a version of *BreakOut*, Nolan Bushnell's 1974 follow-up to the original arcade video game *Pong*.

Not just ordinary *BreakOut*, though, I'll grant you. Here we have a set of bricks, two walls, and two bats. One bat is controlled by moving the mouse up and down, the other by moving left and right.

Pull down the menu by holding down the right mouse button and moving the pointer up to the top-left of the screen. Move down to Instructions and let go of the button for on-screen help. When you're ready to start move down to Begin Game to start the game going. Now press the mouse button to throw the ball, and good luck!

ZOMBIE APOCALYPSE

What's this? An arcade-quality Op Wolf-style shoot-em-up written in Blitz? Must be Acid Software again!



You shouldn't have too much difficulty working out how to play this.



If you do have trouble sussing it out, please dial Freephone MENTAL.

A CITY OF the future. A future where a nuclear explosion has caused vast amounts of the population to mutate into ferocious killer zombies. You, as one of the remaining unmutated survivors, must destroy all traces of the zombies armed with only an automatic weapon and a handful of grenades.

Move the gunsight around the screen using your mouse, and fire at each zombie as it appears by pressing the left mouse button. Throw a grenade at them by pressing the right mouse button.

Now and again crates of bullets (pictured left) and grenades (right) will fall from the top of the screen. Shoot them to reload. Remember - the more accurate you are with your shots, the better you will score.

BACKING UP YOUR DISK

There are two ways of making a copy of your disk, and this is the easy one. Don't be daunted by the fact that you need to use the Shell or CLI - it's actually a lot easier than you might think.

Just follow these simple steps...



1 Load your Workbench disk. Open the disk, find the icon that says Shell or CLI and double-click on it.

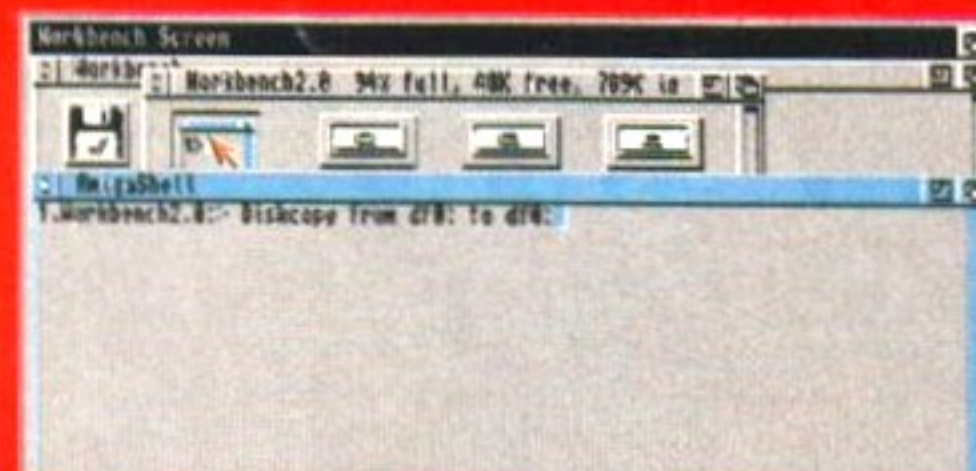

2 When the Shell window appears and the drive light is out, type in (DF0 as in Zero, not DFO as in Oops):
Diskcopy from DF0: to DF0:
and press the Return key.

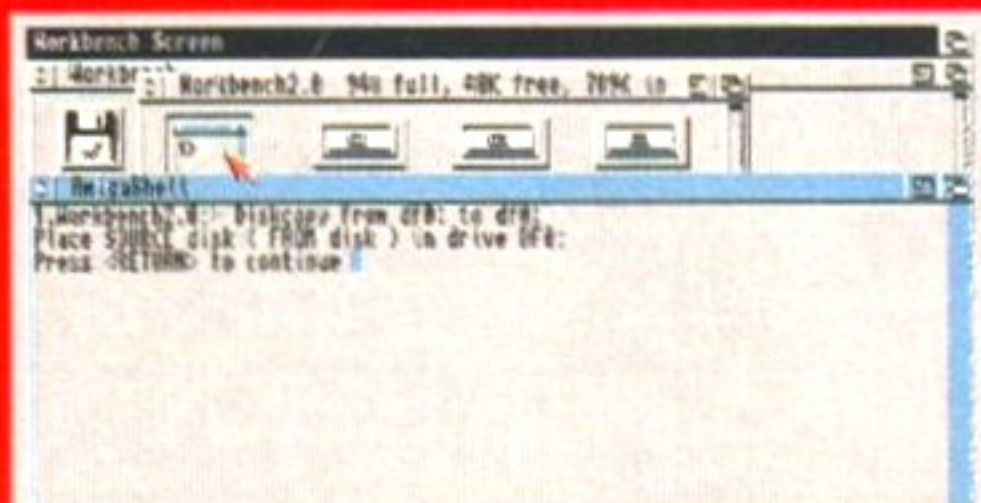

3 The Amiga will now ask you to insert the 'source' disk. It means the disk you want to copy, so put the Coverdisk in the drive and press the Return key.

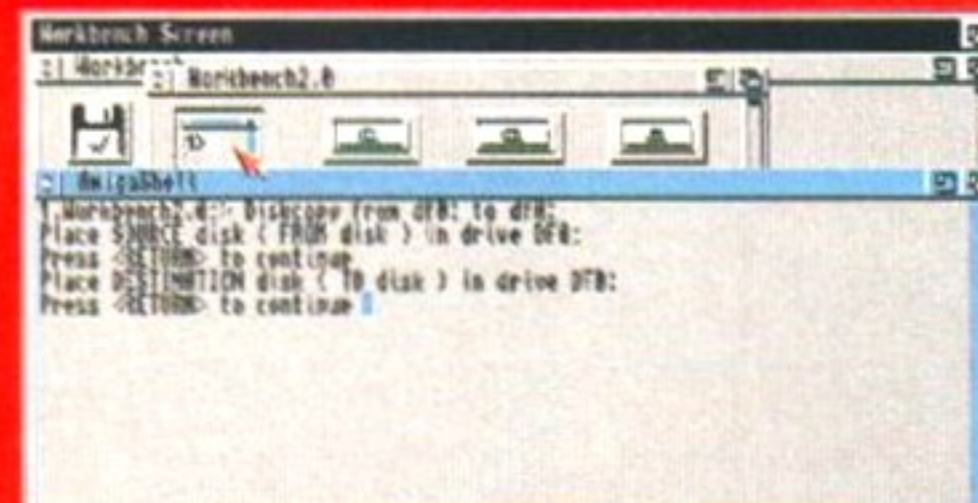

4 Wait for a while and it will read all the information off the Coverdisk, telling you how far it has got. Then it will ask you to insert the 'Destination' disk. Put the disk you want to copy your Coverdisk on to, in the drive and press the Return key. Note that the disk does not need to be formatted already.



5 Put the source disk and destination disk in a couple more times when the Amiga asks for them. When it says "Diskcopy Finished" just type in:
endcli
to get out of the Shell or CLI. You may have to put the Workbench disk in again. Now your copy is ready!

DISK NOT WORKING?

We duplicate in excess of 200,000 disks every month. Out of all those, obviously a few will be faulty. If the disk or any of the programs will not load or run properly, there may be a problem. Don't panic!

You could try using a decent disk recovery and repair program such as *Quarterback Tools* or *AmiBack Pro* (if you don't have either of those, the PD programs *DiskSalv* and *FixDisk* are good too).

However, if your Coverdisk is in fact faulty, you should send it back INCLUDING A STAMPED, ADDRESSED ENVELOPE for a free replacement within one month of the cover date to the address on the right...

Amiga Format November Disk
Disk Copy Labs Ltd
Units 2&3
Omega Technical Centre
Drayton Fields
Daventry
Northants, NN11 5RT

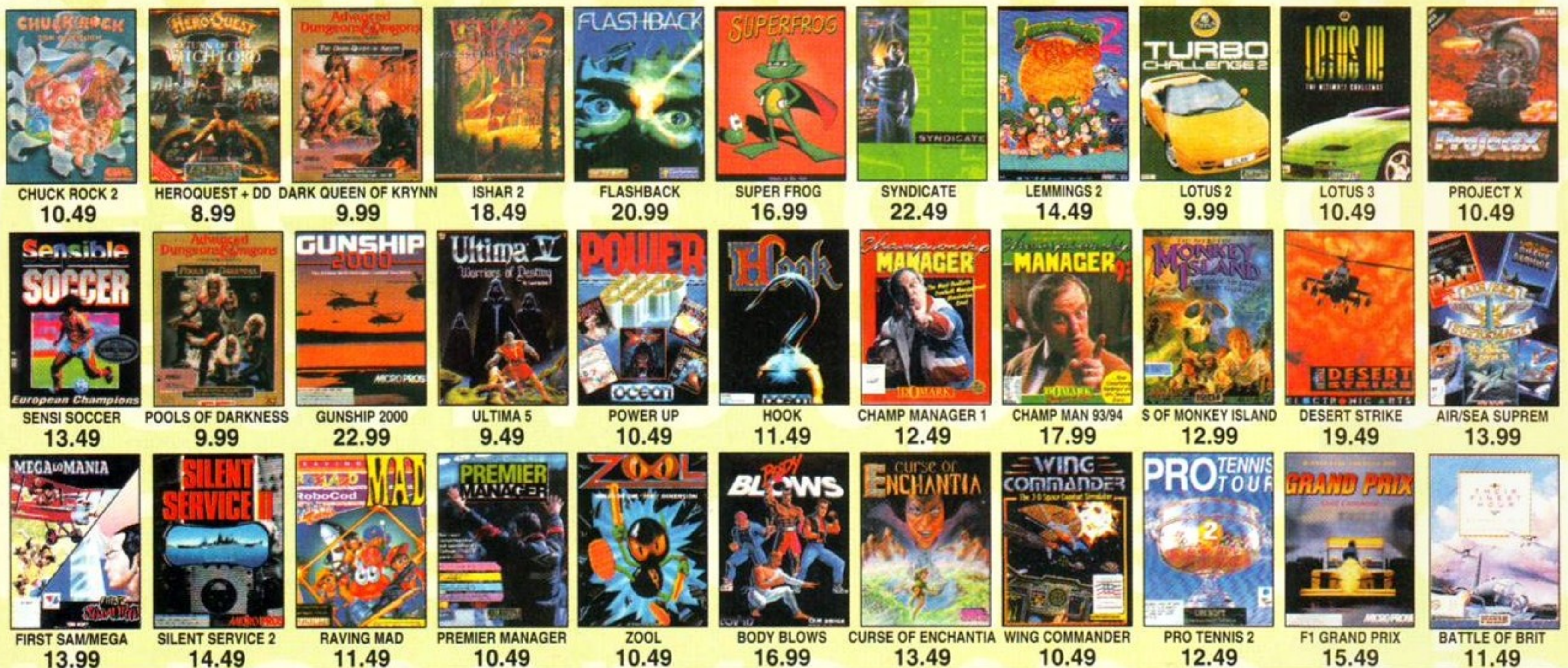

Games marked NOP will not work on A500 Plus, A600 or A1200. Games marked NO12 will not work on the A1200.

688 ATTACK SUB (NO12).....10.49	CAPTIVE 2 - LIBERATION (1 MEG).....20.49	FIRE & ICE.....17.99	KIT VISIOUS.....16.99	QUESTRON 2 (SSI) (NO12).....5.49	STUNT CAR RACER (NO12).....7.99
A-TRAIN (1 MEG).....22.99	CASTLES 2 (A1200 VERSION).....22.49	FIRST SAMURAI + MEGA LO MANIA (NO12).....13.99	KNIGHTMARE.....13.49	R-TYPE (NO12).....7.99	SUPER CARS (NO12).....7.49
A-TRAIN CONSTRUCTION SET (1 MEG).....12.49	CELTIC LEGENDS.....18.49	FLASHBACK OF FREEDOM (MIDWINTER 2).....10.99	KNIGHTS OF THE SKY (1 MEG).....12.99	RAILROAD TYCOON (1 MEG).....14.49	SUPER CARS 2 (NOP).....9.49
A320 AIR-BUS (1 MEG) (NOP).....18.99	CHAMPIONSHIP MANAGER (1 MEG).....12.49	FLASHBACK (1 MEG).....20.99	KRUSTY'S SUPER FUN HOUSE.....18.99	RAINBOW COLLECTION.....17.99	SUPER CAULDRON.....17.99
A320 AIRBUS (USA VERSION) (1 MEG).....22.49	CHAMPIONSHIP MANAGER 93 UPDATE DISK (1 MEG).....9.49	FORMULA 1 GRAND PRIX.....15.49	LAST NINJA 2 (NO12).....7.99	(BUBBLE BOBBLE, RAINBOW ISLANDS, NEW SUPER FROG (1 MEG).....16.99	SUPER FROG (1 MEG).....7.99
ADDAMS FAMILY (1 MEG).....9.99	CHAMPIONSHIP MANAGER 93/94 (1 MEG).....17.99	FUTURE WARS (NO12).....10.49	LEGEND (WORLD OF LEGEND).....13.49	SUPER HANG ON.....18.49	SUPER HERO.....18.99
AIR BUCKS.....18.49	CHAOS ENGINE (A1200 VERSION).....18.49	G2 (1 MEG).....17.99	LEGENDS OF VALOUR (1 MEG).....23.49	SUPER LEAGUE MANAGER (1 MEG).....18.49	SUPER SPACE INVADERS.....9.49
AIR FORCE COMMANDER (1 MEG).....18.49	CHAOS ENGINE.....17.49	GAUNTLET 2.....17.99	LEMMINGS.....12.49	SUPERSKI 2 (NO12).....8.99	SWITCHBLADE 2 (NO12).....9.49
AIR SEA SUPREMACY.....18.49	CHUCK ROCK (NO12).....10.49	GAUNTLET 3 (NO12).....16.49	LEMMINGS DATA DISK - OH NO!.....8.99	SWIN (NOP).....8.99	SYNDICATE (1 MEG).....22.49
(GUNSHIP, SILENT SERVICE, P47, WINGS, CARRIER COMMAND) (NO12).....13.99	CIVILISATION (1 MEG).....23.49	GEAR WORKS.....15.49	LEMMINGS 2.....14.49	TERMINATOR 2.....20.99	TFX (A1200 VERSION).....22.99
AIR SUPPORT.....17.49	CIVILISATION (A1200 VERSION).....25.99	GHOULS 'N' GHOSTS.....7.99	LINKS - THE CHALLENGE OF GOLF (1 MEG).....12.99	THE ADVENTURES (SUPREMACY, HUNTER, CORPORATION) (NO12).....14.49	THE BLUE & THE GREY (1 MEG).....18.99
AIR, LAND & SEA (688 ATTACK SUB, INDY 500, F18 INTERCEPTOR) (NO12).....23.49	COMBAT AIR PATROL.....20.49	GLOBULE.....20.49	LIONHEART.....17.99	THE LOST TREASURES OF INFOCOM 1 (20 CLASSIC INFOCOM TEXT ADVENTURES) (NO12).....20.99	THE SETTLERS.....23.49
AIRBUCKS 1.2 (A1200 VERSION).....18.49	COMBAT CLASSICS (F15 STRIKE EAGLE 2, 688 ATTACK SUB, TEAM YANKEE) (1 MEG).....19.99	GOAL.....20.49	LOMBARD RAC RALLY.....7.99	THEATRE OF DEATH.....20.49	THUNDERHAWK.....10.99
ALFRED CHICKEN (1 MEG).....18.49	COOL SPOT.....20.99	GOBLIINS 2.....18.49	LORD OF THE RINGS.....17.49	TITUS THE FOX.....9.49	TORNADO (1 MEG).....21.49
ALFRED CHICKEN (A1200 VERSION).....17.99	COOL WORLD (1 MEG).....17.99	GOLF WORLD CLASS LEADERBOARD.....8.99	LOST VIKINGS.....19.99	TRANSCARCTICA.....18.49	TURRICAN.....7.99
ALIEN 3.....18.99	CORRUPTION (M/SCROLLS).....7.49	GRAHAM GOOCH DATA DISK.....13.99	LOTUS TURBO CHALLENGE 2 (NO12).....9.99	TV SPORTS BOXING (NO12).....13.49	TV SPORTS FOOTBALL (NO12).....6.49
ALIEN BREED (SPECIAL EDITION) (1 MEG).....9.49	CRAZY CARS 3.....14.49	GRAHAM GOOCH WORLD CLASS CRICKET (1 MEG).....18.49	LOTUS 3 - THE FINAL CHALLENGE (1 MEG) (NO12).....10.49	ULTIMA 5 (NO12).....9.49	ULTIMA 5 (NO12).....9.49
ALIEN BREED 2 (1 MEG).....17.49	CRUISE FOR A CORPSE.....11.99	GRAHAM TAYLOR'S SOCCER MANAGER (1 MEG).....11.49	LURE OF THE TEMPTRESS (1 MEG).....19.49	UTOPIA + DATA DISK (SIM CITY, FUTURE CITIES & TERRAIN EDITOR).....22.99	VALKERS.....19.99
ALIEN BREED 2 (A1200 VERSION).....18.99	CRYSTAL KINGDOM DIZZY.....13.49	GRAND PRIX CIRCUIT.....14.49	M1 TANK PLATOON (1 MEG).....11.49	WAR IN THE GULF.....19.99	WAXWORKS (1 MEG).....22.99
AMBERSTAR.....18.49	CURSE OF ENCHANTIA (1 MEG).....13.49	GUNSHIP 2000 (1 MEG).....22.99	MAGIC BOY.....17.99	WHEN TWO WORLDS WAR (1 MEG).....21.49	WING COMMANDER 1 (1 MEG).....10.49
AMERICAN GLADIATORS.....17.99	CYBERSPACE (1 MEG).....22.99	HARLEQUIN.....17.49	MAGIC WORLDS (STORM MASTER, DRAGONS BREATH, CRYSTALS OF ARBOREA) (NO12).....16.49	WIZ N LIZ.....20.49	WONDERDOG.....14.49
AMNIO.....9.49	D-GENERATION.....13.49	HEAD OVER HEELS.....7.99	MANCHESTER UNITED.....9.49	WOODY'S WORLD.....17.99	WWF WRESTLING (NO12).....11.49
ANOTHER WORLD.....17.49	DARK QUEEN OF KRYNN (1 MEG).....9.99	HEIMDALL (1 MEG) (NO12).....12.49	MANIC MANSION (NO12).....10.49	WWF WRESTLING 2 (1 MEG).....17.49	XENON 2 MEGABLAST.....9.49
APACHE.....7.99	DARKMERE (1 MEG).....17.49	HEROQUEST + DATA DISK (NO12).....8.99	MICRO MACHINES.....16.99	YO JOE.....20.99	ZAK MCKRACKEN (NO12).....10.49
APOCALYPSE (1 MEG).....20.49	DARKSEED (1 MEG).....21.49	HEROQUEST 2 - THE LEGACY OF SORASIL (1 MEG).....17.49	MICROPOLY 3D GOLF (1 MEG).....12.99	ZAK MCKRACKEN (NO12).....10.49	ZOO (A1200 VERSION).....18.49
AQUATIC GAMES.....17.49	DARKSEED (A1200 VERSION).....19.49	HILL STREET BLUES (NO12).....9.49	MORTAL KOMBAT (1 MEG).....20.99	ZOO (1 MEG).....10.49	ZOO 2 (1 MEG).....16.99
ARABIAN NIGHTS.....16.49	DARKSEED (A1200 VERSION).....19.49	HIREGUNS (1 MEG).....22.49	MR NUTZ (A1200 VERSION).....20.99		
ARABIAN NIGHTS (A1200 VERSION).....19.49	DESSERT STRIKE (1 MEG).....19.49	HISTORYLINE 1914-18 (1 MEG).....22.99	NICK FALDO'S GOLF (ROBOCOP, GHOSTBUSTERS 2, INDIANA JONES ACTION, BATMAN THE MOVIE) D/S (NOP).....9.99		
ARCHER MACLEAN'S POOL.....18.49	DISPOSABLE HERO.....16.99	HOLLYWOOD COLLECTION.....14.99	NIGEL MANSELL'S WORLD CHAMP SHIP (1 MEG).....15.99		
ASSASSIN (1 MEG).....12.49	DIZZY PRINCE YOLK FOLK.....7.99	HUNTER (NO12).....7.99	NIGEL MANSELL'S WORLD CHAMP SHIP (A1200 VERSION).....18.99		
ASSASSIN REMIX.....9.99	DIZZY'S EXCELLENT ADVENTURE.....16.49	IMMORTAL (NO12).....10.49	NIPPO SAFES (1 MEG).....20.49		
AV8B HARRIER ASSAULT.....22.49	DOG FIGHT (1 MEG).....22.99	INDIANA JONES ADVENTURE.....11.49	OPERATION STEALTH (NO12).....11.49		
B.A.T. 2.....23.49	DONK (1 MEG).....18.49	INDIANA JONES 2 ACTION (FATE OF ATLANTIS).....17.99	PATRICIAN (1 MEG).....20.49		
B17 FLYING FORTRESS (1 MEG).....23.49	DREACLANDS (TRANSARCTICA, STORM MASTER, ISHAR) (1 MEG).....18.99	INDIANA JONES FATE OF ATLANTIS.....17.99	PERFECT GENERAL.....22.99		
BATMAN RETURNS.....17.99	DREAMWEG (1 MEG).....22.99	ADVENTURE (1 MEG).....24.49	PERFECT GENERAL DATA DISK.....14.49		
BATMAN THE MOVIE.....7.99	DUNE (1 MEG).....19.49	INDY JONES (ACTION).....19.49	PERIHELION (1 MEG).....20.49		
BATTLE ISLE.....13.99	DUNE 2 - BATTLE FOR ARRAKIS (1 MEG) 20.49	INTERNATIONAL RUGBY CHALLENGE.....14.99	PGA TOUR GOLF + COURSES.....19.99		
BATTLE ISLE 93.....16.49	DUNGEON MASTER & CHAOS STRIKES BACK (1 MEG).....13.99	INTERNATIONAL SPORTS CHALLENGE (NO12).....18.99	PGA TOUR GOLF COURSE DISK.....11.99		
BATTLE OF BRITAIN.....11.49	DYNA BLASTERS.....20.49	INDY JONES (ACTION).....19.49	PINBALL DREAMS (1 MEG).....13.49		
BEACH VOLLEY (NO12).....7.99	ELITE.....12.49	IT CAME FROM THE DESERT PLUS ANT HEADS DATA DISK (1 MEG).....13.49	PINBALL FANTASIA (1 MEG).....18.49		
BENEATH THE STEEL SKY (1 MEG).....20.99	ELITE 2 (FRONTIER).....22.49	JACK NICKLAUS GOLF.....6.49	PLAYER MANAGER (NO12).....9.49		
BENEFACATOR (1 MEG).....20.49	EPIC (1 MEG).....17.99	JAGUAR XJ220 (1 MEG).....11.49	POOLS OF DARKNESS.....9.99		
BLACK CRYPT (1 MEG).....16.49	EUROPEAN CHAMPIONS (1 MEG).....17.99	JAMES POND 2 - ROBOCOP.....17.49	POPULOUS & SIM CITY.....17.49		
BLASTAR (1 MEG).....14.49	EYE OF THE BEHOLDER (SSI) (1 MEG).....20.49	JIMMY WHITES SNOOKER.....15.99	POPULOUS 2 (1 MEG) + CHALLENGE DATA DISK.....22.49		
BLOB.....14.49	EYE OF THE BEHOLDER 2 (1 MEG).....24.49	JOHN MADDEN'S (U.S.) FOOTBALL.....17.99	POWER UP (CHASE H.Q. TURRICAN, X-OUT, ALTERED BEAST, RAINBOW ISLANDS).....10.49		
BLUES BROTHERS.....7.49	F1 (DOMARK) (1 MEG).....17.99	JURASSIC PARK (1 MEG).....17.99	PREMIER MANAGER (1 MEG).....10.49		
BOB'S BAD DAY.....17.99	F117A SEALTH FIGHTER 2.0 (1 MEG).....22.99	JURASSIC PARK (A1200 VERSION).....19.49	PREMIER MANAGER 2 (1 MEG).....16.49		
BODY BLOWS (1 MEG).....16.99	F15 STRIKE EAGLE 2 (1 MEG).....12.49	K240 (UTOPIA 2) (1 MEG).....18.49	PREMIERE (1 MEG).....12.49		
BODY BLOWS (A1200 VERSION).....19.49	F17 CHALLENGE.....10.49	KICK OFF 2 (1 MEG) (NO12).....9.49	PRINCE OF PERSIA (1 MEG).....7.99		
BODY BLOWS GALACTIC (1 MEG).....17.49	F19 STEALTH FIGHTER (NOP).....11.49	KINGDOMS OF GERMANY (1 MEG).....19.49	PRO TENNIS TOUR 2.....12.49		
BODY BLOWS GALACTIC (A1200 VERSION).....18.99	FABLES & FIENDS - LEGEND OF KYRANDIA (NO12) (1 MEG).....23.99		PROJECT X (SPECIAL EDITION) (1 MEG).....10.49		
BOSTON BOMB CLUB (NO12).....8.99	FACE OFF ICE HOCKEY (NO12).....9.49		PUGGSY (1 MEG).....20.49		
BOXING MANAGER (NO12).....8.49	FANTASTIC WORLDS (REALMS, PIRATES, MEGA LO MANIA, POPULOUS, WONDERLAND) (1 MEG) (NO12).....23.49		QUEST & GLORY (QUESTD, WYCH, MIDWINTER, CADAVER, BAT) (NO12).....13.49		
BRIAN THE LION.....17.99					
BUBBA N STIX.....14.49					
BURNING RUBBER.....17.99					
BURNING RUBBER (A1200 VERSION).....18.49					
CAESAR (1 MEG) (NO12).....18.49					
CAESAR DELUXE.....18.49					
CAMPAIGN (1 MEG).....22.49					
CAMPAIGN 2 (1 MEG).....22.99					

HUNDREDS MORE GAMES AVAILABLE IF YOU DON'T SEE WHAT YOU WANT PLEASE CALL 0279 600204

DISK DRIVES

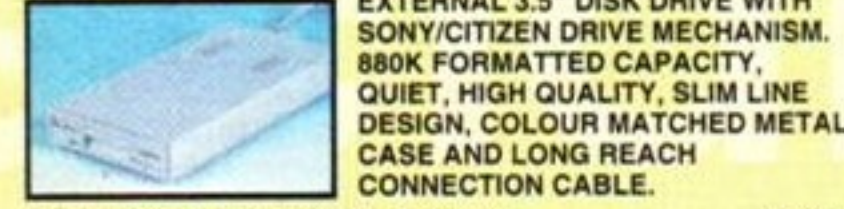

EXTERNAL 3.5" DISK DRIVE WITH SONY/CITIZEN DRIVE MECHANISM. 880K FORMATTED CAPACITY, QUIET, HIGH QUALITY, SLIM LINE DESIGN, COLOUR MATCHED METAL CASE AND LONG REACH CONNECTION CABLE.

EXTERNAL DISK DRIVE FOR AMIGA54.99
 CUMANA EXTERNAL 3.5" DISK DRIVE FOR AMIGA (VERY HIGH QUALITY)69.99
 ZYDEC INTERNAL REPLACEMENT DISK DRIVE FOR AMIGA. REPLACES EXISTING DRIVE. INVALIDATES WARRANTY WHEN FITTED.47.99

HARD DRIVES

GVP A530 TURBO HARD DRIVES FOR A500 OR A500P. WITH 40MHz 68030EC ACCELERATOR BOARD BUILT-IN. INCREASES THE SPEED OF YOUR COMPUTER SIGNIFICANTLY. 1 MEG RAM INCLUDED, EXPANDABLE TO 8 MEG. AWARD WINNING DESIGN. IDEAL FOR USE WITH SPREADSHEETS, DTP AND WORD PROCESSING PROGRAMS.

GVP A530 (120MB) TURBO HARD DRIVE639.99
 GVP A530 (80Mb) TURBO HARD DRIVE549.99
 GVP HD8+ 42 MEGABYTE AMIGA A500 AND A500 PLUS HARD DRIVE (SERIES II), RAM EXPANDABLE TO 8 MEG (SIMMS), PC EMULATOR SOCKET254.99

TOSHIBA IDE HARD DRIVE FOR AMIGA A600 OR A1200. INCLUDES EVERYTHING NECESSARY TO FIT INTERNALLY. INVALIDATES WARRANTY WHEN FITTED.

TOSHIBA 40Mb IDE HARD DRIVE.....114.99
 TOSHIBA 80Mb IDE HARD DRIVE194.99

JOYSTICK EXTRAS

PORT EXTENSION ADAPTOR FOR AMIGA (CHANGE JOYSTICKS WITHOUT NEEDING TO REACH BEHIND COMPUTER).....5.99
 ROBOSHIFT INTERFACE FOR AMIGA (PLUGS MOUSE & JOYSTICK INTO ONE PORT).....12.99

MEMORY UPGRADES

512K AMIGA RAM WITH CLOCK FOR A500 AND A500+ 29.99
 512K AMIGA RAM WITHOUT CLOCK FOR A500 AND A500+ 24.99
 1 MEGABYTE A500 PLUS RAM UPGRADE WITH CLOCK 32.99
 1 MEGABYTE A600 RAM UPGRADE WITH CLOCK39.99
 2 MEG PCMCIA UPGRADE FOR A600 OR A1200. PLUGS DIRECTLY INTO SMART CARD SLOT. THESE ARE NOT BATTERY BACKED AND CAN'T BE USED AS A DISK, ONLY AS RAM.114.99
 4 MEG PCMCIA UPGRADE FOR A600 OR A1200. PLUGS DIRECTLY INTO SMART CARD SLOT. THESE ARE NOT BATTERY BACKED AND CAN'T BE USED AS A DISK, ONLY AS RAM.164.99

CLEANING

CLEANING KIT FOR COMPUTERS (INCLUDES VACUUM) 19.99

DUST COVERS

DUST COVER FOR A1200 (CLEAR PVC)4.99
 DUST COVER FOR A6004.99
 DUST COVER FOR AMIGA A500 OR ATARI ST (CLEAR PVC)4.99
 DUST COVER FOR MONITOR (CLEAR PVC)4.99

LEADS

HI-FI LEAD FOR AMIGA (STANDARD PHONO INPUT)3.99
 MONITOR LEAD FOR AMIGA TO PHILIPS CM8833 MK2 MONITOR.....7.99
 NULL MODEM CABLE7.99
 SCART LEAD FOR AMIGA TO GOLDSTAR TELEVISION9.99
 SCART LEAD FOR AMIGA TO SONY TELEVISION9.99

SCART LEAD FOR AMIGA TO TELEVISION WITH SCART INPUT (GIVES MONITOR QUALITY PICTURE).....9.99
 SCART TO SCART LEAD FOR TV TO VIDEO (GIVES EXCEPTIONAL ENHANCED QUALITY PICTURE)8.99

HAND SCANNERS

POWER SCAN HAND SCANNER FOR AMIGA (VERSION 3). TRUE GREY SCALE, 100-400DPI (INCLUDES SOFTWARE).....104.99

WORK CENTRES

DELUXE WORK CENTRE (RSD) (STEEL MONITOR STAND WITH EXTRA SHELF FOR EXTERNAL DISK DRIVE AND ACCESSORIES, MOUSE HOLDER, MOUSE MAT AND ALL IN ONE DUST COVER).....42.99
 DELUXE WORK CENTRE (RSD) FOR AMIGA A500 OR A500 P 44.99
 PREMIER CONTROL CENTRE FOR AMIGA A600 (STEEL MONITOR STAND WITH EXTRA SHELF FOR EXTERNAL DISK DRIVE AND ACCESSORIES. CUSTOM FIT FOR THE A600)32.99

MUSIC & SOUND EQUIPMENT

GVP DIGITAL SOUND STUDIO. STEREO SOUND SAMPLER FOR AMIGA 500, 600 AND 1200. EXCELLENT SOFTWARE PACKAGE INCLUDED.....37.99

SCREENBEAT STEREO SPEAKERS FOR AMIGA OR IBM PC. REQUIRES 4AA BATTERIES OR MAINS ADAPTOR. DESIGNED SPECIFICALLY FOR COMPUTERS, INCLUDING MOUNTINGS FOR ATTACHMENT TO MONITOR.....18.99
 MAINS ADAPTOR FOR SCREENBEAT SPEAKERS7.99

VIDEO EQUIPMENT

ROCTEC GENLOC PLUS FOR AMIGA.144.99

VIDI AMIGA 12 (CAPTURES COLOUR IMAGES FROM VIDEO MACHINE OR CAMCORDER. COMPATIBLE WITH TAKE 2, DELUXE PAINT 4 AND MOST ART PACKAGES) 72.99

POWER SUPPLY

ZYDEC AMIGA POWER SUPPLY (SPECIAL COOL RUNNING TRANSFORMER).....32.99

DISKS & DISK BOXES

BANX DISK BOX 3.5" (110) STACKABLE13.99
 BANX DISK BOX 3.5" (80) STACKABLE12.49
 DELUXE DISK BOX 3.5" (80), LOCKABLE, DIVIDERS9.99
 DISK BOX 3.5" (10 CAPACITY)1.99
 DISK BOX 3.5" (120) LOCKABLE, DIVIDERS9.99
 PACK OF 10 VERBATIM 3.5" DSDD DISKS WITH LABELS (BRANDED).....7.99
 PACK OF 50 VERBATIM 3.5" DSDD DISKS WITH LABELS (BRANDED).....27.99

VERBATIM =
 3.5" DSDD DISKS WITH LABELS
 PACK OF 10
 7.99
 GG9137

PACK OF 50 27.99
 GG5535

AMIGA DEALS + CD-32

COMMODORE AMIGA A600 LEMMINGS PACK

SAVE £50



174.99

WITH DELUXE PAINT 3 AND LEMMINGS, BUILT-IN TV MODULATOR, MOUSE, 1 MEG RAM EXPANDABLE TO 10 MEG, 32 BIT 68000 14MHz PROCESSOR, AGA GRAPHICS CHIPSET
1 YEAR IN-HOME SERVICE WARRANTY

COMMODORE AMIGA A1200 LEMMINGS PACK

SAVE £60



264.99

WITH DELUXE PAINT 3 AND LEMMINGS, MOUSE, BUILT-IN TV MODULATOR, 2 MEG RAM EXPANDABLE TO 10 MEG, 32 BIT 68020 14 MHz PROCESSOR, AGA GRAPHICS CHIPSET,
1 YEAR IN-HOME SERVICE WARRANTY

COMMODORE AMIGA CD-32 CONSOLE

SAVE £14



285.99

CD BASED CONSOLE WITH AMIGA A1200 POWER, 256,000 COLOURS FROM 16 MILLION. COMPLETE WITH OSCAR AND DIGGERS CD GAMES, 2 MEG RAM AND 11 BUTTON JOYPAD. CAN PLAY AUDIO CD'S AND CD+G DISCS.

SAVE £70

COMMODORE AMIGA A600 LEMMINGS PACK AS ABOVE COMPLETE

WITH SONY 14" FST KVM1400 COLOUR TV/MONITOR AND SCART LEAD

354.99

SAVE £85

COMMODORE AMIGA A1200 LEMMINGS PACK AS ABOVE COMPLETE WITH

SONY 14" FST KVM1400 COLOUR TV/MONITOR AND SCART LEAD

439.99

SAVE £43 ON RRP

COMMODORE AMIGA CD-32 AS ABOVE COMPLETE WITH SONY

14" FST KVM1400 COLOUR TV/MONITOR & SCART LEAD

465.99



194.99

SONY 14" FST COLOUR TELEVISION/MONITOR MODEL KVM1400 WITH REMOTE CONTROL FREE SCART LEAD

(STATE SNES, MEGADRIVE, AMIGA or ST)

AVAILABLE IN WHITE AT NO EXTRA COST FOR FASTEXT OPTION PLEASE ADD £50

SONY TV/MONITOR ENABLES MONITOR QUALITY PICTURE FROM AMIGA, SUPER NES, ST OR MEGADRIVE VIA SCART CONNECTION. ALSO SUITS ALL CONSOLES VIA NORMAL RF INPUT. INCLUDES REAR SCART/EURO. 60 CHANNEL TUNING. BLACK TRINITRON SCREEN. TWO POSITION TILT DESIGN FOR CHOICE OF ANGLE. INCLUDES LOOP AERIAL. SUPERB QUALITY.



COMMODORE 1084ST COLOUR STEREO MONITOR FOR ANY AMIGA

1 YEAR WARRANTY OFFICIAL UK VERSION FREE AMIGA MONITOR LEAD & FREE TILT AND SWIVEL MONITOR STAND

189.99

GOLDSTAR 14" COLOUR TELEVISION/MONITOR WITH REMOTE CONTROL & SCART INPUT

FREE SCART LEAD (STATE SNES, SEGA OR AMIGA) GIVES PIXEL PERFECT PICTURE

154.99

FOR A FREE CATALOGUE PLEASE CALL 0279 600204



CHEETAH BUG JOYSTICK (AMIGA FORMAT GOLD) 13.99



MINI COMPETITION PRO 5000 JOYSTICK 12.99



QUICKJOY TOP STAR JOYSTICK 19.99



SPEEDKING ANALOGUE JOYSTICK FOR AMIGA (FOR PROPORTIONAL CONTROL ON SUITABLE SOFTWARE) 12.99

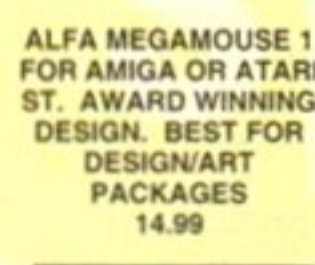

ALFA MEGAMOUSE 1 FOR AMIGA OR ATARI ST. AWARD WINNING DESIGN. BEST FOR DESIGN/ART PACKAGES 14.99



COMPETITION PRO EXTRA JOYSTICK (CLEAR BASE) 10.99



MINI COMPETITION PRO STAR JOYSTICK WITH AUTOFIRE 15.99



QUICKSHOT 128F MAVERICK 1 JOYSTICK 12.99



SUPER PRO ZIP STICK JOYSTICK FOR AMIGA OR ST WITH AUTOFIRE FUNCTION 12.99

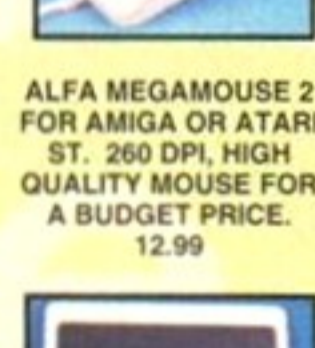

ALFA MEGAMOUSE 2 FOR AMIGA OR ATARI ST. 260 DPI, HIGH QUALITY MOUSE FOR A BUDGET PRICE. 12.99



FREEWHEEL STEERING WHEEL (DIGITAL) FOR AMIGA (WORKS AS A JOYSTICK OR WITH FOOTPEDAL) SUITS MOST DRIVING GAMES 25.99

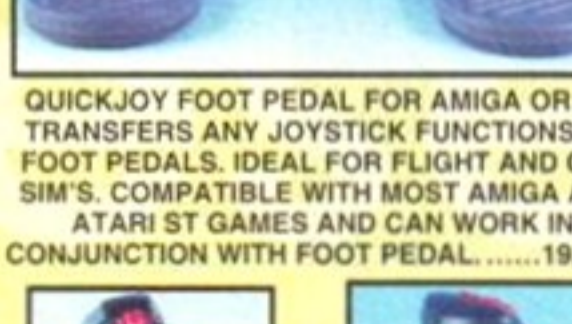

QUICKJOY FOOT PEDAL FOR AMIGA OR ST. TRANSFERS ANY JOYSTICK FUNCTIONS TO FOOT PEDALS. IDEAL FOR FLIGHT AND CAR SIM'S. COMPATIBLE WITH MOST AMIGA AND ATARI ST GAMES AND CAN WORK IN CONJUNCTION WITH FOOT PEDAL.....19.99



TROJAN LIGHT PHAZER GUN WITH SKEET SHOOT AND ORBITAL DESTROYER GAMES (OTHER GAMES AVAILABLE - SEE "TROJAN" IN SOFTWARE LISTINGS) 29.99

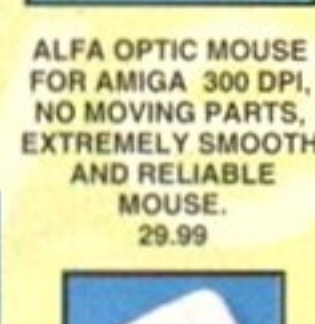

ALFA OPTIC MOUSE FOR AMIGA 300 DPI, NO MOVING PARTS, EXTREMELY SMOOTH AND RELIABLE MOUSE. 29.99



GRAVIS JOYSTICK FOR AMIGA WITH FOAM PADDED GRIP, ADJUSTABLE HANDLE TENSION AND PROGRAMMABLE FIRE BUTTONS 23.49



QUICKJOY JET FIGHTER JOYSTICK 11.99



QUICKSHOT 137F PYTHON JOYSTICK 9.99

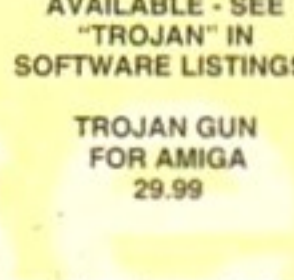

TROJAN GUN FOR AMIGA 29.99

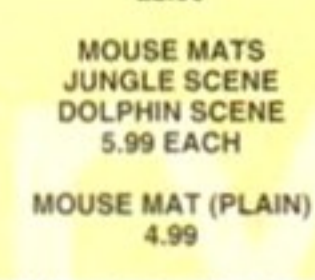

DRAGON MOUSE FOR AMIGA 280 DPI. 12.49

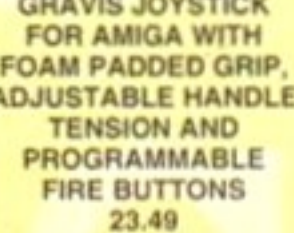

QUICKJOY QJ1 JOYSTICK (MICROSWITCHED) 7.99



QUICKSHOT 155 AVIATOR 1 JOYSTICK 23.99

CITIZEN 120D+ 9-PIN MONO PRINTER

80 COLUMN, 144 CPS/25NLO, 2NLQ/1 DRAFT FONT, 2 YEAR WARRANTY FREE PRINTER LEAD

124.99

CITIZEN SWIFT 90C 9-PIN COLOUR PRINTER

9 PIN, 80 COLUMN 240CPS/54NLO 6NLO FONTS, 2 YEAR WARRANTY FREE PRINTER LEAD

164.99

CITIZEN 200 24-PIN COLOUR PRINTER

WITH COLOUR KIT, 24 PIN, 80 COLUMN 216CPS/72LQ6 LQ/1 DRAFT FONT, AUTO SET FACILITY, INPUT DATA BUFFER, AUTO PAPER LOADING, ENVELOPE PRINTING, 2 YEAR WARRANTY FREE PRINTER LEAD

216.99

CITIZEN 240C 24-PIN COLOUR PRINTER

WITH COLOUR KIT, 24 PIN, 80 COLUMN, 240CPS/80LQ 9 LQ/1 DRAFT FONT, 2 YEAR WARRANTY FREE PRINTER LEAD

259.99

CANON BJ-10SX BUBBLE JET PRINTER

64 NOZZLE, 80 COLUMN, 110LQ CPS 2LQ/3 DRAFT FONT, 1 YEAR WARRANTY FREE PRINTER LEAD

215.99

SEGA MEGADRIVE 2 + SONIC 2 TWO SEGA JOYPADS GENUINE UK VERSION

109.99

SUPER NES + MARIO ALL STARS 1 NINTENDO JOYPAD GENUINE UK VERSION

109.99



Special Reserve members can have all this... can YOU?

- READ "NRG" Regular Club Magazine
 - CHOOSE from our Huge Selection
 - BUY at Best Possible Prices
 - SAVE with our Special Deals
 - SAVE more with our XS Coupons
 - WIN £60,000 worth of prizes FREE
- JOIN now from just £4.99

We only supply members but you can order as you join

There's no obligation to buy and you can be any age. Just send in the form below or phone Sales on 0279 600204.

As a member of Special Reserve you'll receive regular issues of NRG magazine. NRG is our 48 page colour club magazine sent bi-monthly only to Special Reserve members. NRG contains:

- The best selection of games, peripherals and hardware for all popular formats. We are official Sega, Nintendo and Sony stockists.
- Reviews in colour and latest information on new products
- Charts and Release Schedule, to help you choose and plan
- The best prices. Just one purchase will save you your joining fee
- Hundreds of Special Offers. Top games at prices you won't believe
- XS Super Savers. Money-off coupons worth over £180 a year
- £60,000 worth of prizes per year in our FREE-to-enter BIG TARGET COMPETITIONS. That's £10,000 worth in every issue of NRG, exclusive to members.

That's why over 160,000 people have joined Special Reserve, the biggest games club in the World!

0279 600204

9am to 8pm Weekdays, 9am to 5pm Saturday, 10am to 5pm Sunday
10am to 5pm Bank Holidays. Order/Confirmation/Receipt sent for every order.

THERE ARE NO SURCHARGES ON ORDERS

You can also Fax your order to us on: 0279 726842

We pride ourselves on our after-sales service. (18 customer service lines) Inevitably some games listed may not yet be available. Please phone sales on 0279 600204 to check availability before ordering. In the event of delay we issue refunds on request at any time prior to despatch. We reserve the right to change prices without prior notification. E & O.E.

Registered Office & Club Shop: Inter-Mediate Ltd, 2 South Block, The Maltings, Sawbridgeworth, Herts. CM21 9PG.

All prices include VAT and carriage to UK mainland. See base of order form for overseas surcharges. We supply hardware only to UK mainland addresses.

MEMBERSHIP FEES	6 MONTHS TRIAL MEMBERSHIP	ONE YEAR ANNUAL MEMBERSHIP	TWO YEARS WITH FREE HARD BINDER
UK MEMBERS	4.99	7.99	14.99
OVERSEAS EC MEMBERS	6.00	10.00	20.00
OVERSEAS WORLD MEMBERS	7.00	12.00	24.00

WE ONLY SUPPLY MEMBERS BUT YOU CAN ORDER AS YOU JOIN. THERE ARE NO SURCHARGES (PLEASE PRINT IN BLOCK CAPITALS)

Name _____

Address _____

Postcode _____

Phone _____ Machine _____

Enter membership number (if applicable) or NEW MEMBERSHIP FEE (ANNUAL UK 7.99)

item _____

item _____

item _____

item _____

ALL PRICES INCLUDE UK POSTAGE & VAT £

Cheque/P.O./Access/Mastercard/Switch/Visa (Switch Issue No _____)

Card expiry date _____ Signature _____

Cheques payable to: SPECIAL RESERVE P.O. BOX 847, HARLOW, CM21 9PH

Overseas Orders Surcharge (EC or World): Software orders please add £2.00 per item. Non-software items please add 25%. Hardware items supplied to UK mainland only. Overseas orders must be paid by credit card.

We only supply official UK products. Official suppliers of all leading brands. We sell games and peripherals all at amazing prices for Megadrive, Master System, Game Gear, Super NES, Gameboy, NES, Lynx, Amiga, Atari ST, PC, CD ROM and Apple Mac. And we sell T-shirts and cuddly toys!

Special Reserve Club Shop at The Maltings, Sawbridgeworth, Herts. Open to 7pm Weekdays and to 5pm Saturdays.

MORE SOUND ADVICE (FROM NISHIZAWA)



L

A

S

E

R

PRINTERS

“It’s because I’ve spent two years getting the new Star LS-5 Series right that I’m sure it’s right for you. In quality, features, value-for-money, and compatibility with your existing PC and software.

Mind you, it wasn’t easy. Designing a series to meet the needs of so many different people and systems. Squeezing them into an incredibly small footprint. And specifying as standard, many features usually only available in far more expensive models.

Such as the RISC processor I installed for the first time on this level of printer to give you first page printing at a speed comparable with costlier machines.

And what about the way I insisted on improved typeface technology. On each model – like the LS-5 low cost general

purpose printer there are 14 resident bitmapped fonts and 15 TrueType softfonts for Windows 3.1 on disk.

More than that, the LS-5 EX (a very fast stand alone or networked printer) has

an extra 8 scalable PCL-5 Agfa Intellifonts and upgrade paths to TrueImage (Microsoft PostScript) and AppleTalk. While for the ultimate in DTP performance and flexibility, the LS-5 TT also has additional 35 TrueImage PostScript resident fonts for true WYSIWYG on Windows and Apple Mac.

And just wait till you see how Star’s unique Resolution Enhancement Procedure (REP)* produces a **genuine** 600x300 dpi. Add this to the new combined *microfine toner/drum* cartridge and the improvement in print definition is clear!

Turning to paper handling I was determined to give you the flexibility to meet virtually all printing needs: from large mail shots to heavy duty envelopes. So apart from dual source (50 + 250 sheets) there’s also a third source option to give an 800 sheet capacity in four paper sizes.

To help increase your business efficiency I specified automatic dual interfaces and user modes which will enable PC users to share printers within the company.

And then I ... well unfortunately I’ve run out of space! But if what you’ve read so far sounds good, send off the coupon for even more details on the superb LS-5 Series. ”



Nishizawa
Nishizawa – Star’s Senior Product Development Engineer

Star Micronics U.K. Ltd., Star House, Peregrine Business Park, High Wycombe, Buckinghamshire HP13 7DL. Tel: 0494 471111. Fax: 0494 473333.

* Available on LS-5 EX & LS-5 TT.
A division of Star Micronics Co. Ltd., Japan.

I’d like even more sound advice on the new Star LS-5 Series

NAME: _____ POSITION: _____

COMPANY: _____

ADDRESS: _____

POSTCODE: _____

TEL: _____ FAX: _____

THE DAVE ROBERTS COLUMN

The former deputy editor of trade magazine CTW, now a power-packed industry insider, reveals the latest whispers in the Amiga world.

TO YOU, THE Amiga CD³² might look like sex in a box. To others, it looks suspiciously like a white flag. With the release of a console, has Commodore conceded that there is no longer a home computer market? Apparently not. UK MD David Pleasance claims that while he believes CD³² will outsell the A1200, the disk-based keyboard-included thing called a home computer will survive. Well, possibly. But then Sheffield United tend to survive. Simply surviving isn't really much of a future.

One fact is that there will always be computers in the home. Some people will want to work from home and they will need a computer. And consoles are computers on a long holiday. But a computer in the home isn't home computing. Home computing is a concept that defines a consumer - probably you. It means that the computer was bought to do everything on.

ONCE, HOME COMPUTING was highly fashionable and the Amiga was the leading supermodel. The idea was that there was a generation of late teens/early twenties who had grown up with Speccys, C64s, or whatever as part of their lives and so were games-mad and computer literate.

Soaring sales supported the theory as the Amiga built up a user base of over a million. It was king. But into each reign a little life must fall and recently the concept of home computing has looked wobbly. How many Amigas bought in the past five years are still being used to zap aliens, design cars and organise cashflow all on the same day? And how many are being used about as regularly as Stevie Wonder's kaleidoscope?

Sure the Amiga might have been bought with good intentions, but did it end up as what the consumer wanted all along - a games machine? Let's not forget that at the time the Amiga was the best games machine on the market. And if it was bought for serious work and those intentions remained, how many of the original buyers now have a PC or Mac at work and find it easier to have the same machine at home?

SO WHO IS buying the Amiga these days? Who is 'home computing' now? We seem to be in a transitional period where the multi-purpose machine doesn't fit too comfortably. At well under £100, 16-bit consoles are the best choice if you want a games machine. OK, the carts can be pricey, but Nintendo has recently cut prices with most big-name games now £39.99 (and considered good value by the Mario millions out there).

For the computing side of things, PC prices are coming down and even business heavyweights such as Compaq are believed to be considering bundling a few games with their lower-end options. And if you want a bit of both worlds, then - hell - why not buy both machines? A PC is always a pretty sound investment and the SNES, well it's only £75 in Toys R Us.

That is not to say that the concept of one-machine-does-it-all is on the way out. On the contrary, the idea of one box performing myriad tasks has never been more to the fore.

It's just that this time the concept goes far beyond what we understood by the term home computing and, therefore, well beyond the reach of the Amiga. One of the main reasons for this is that the disk is dead. Well, it's certainly dying. The biggest software publisher in the world, Electronic Arts, has already said that it is embarking on no new disk development.

THE CONSENSUS IS that CD is the software of the future. So the hardware can bridge all sorts of markets - music, video, games, business and others that haven't yet been dreamed of.

At the moment the only thing that can't be done is compute - because you can't write on to a CD - but a new format, Son of CD, will undoubtedly change that. Then home computing will be swallowed up by a greater beast probably called 'Home Everything' - games, movies, music, work, shopping, networking - and the new concept will be controlled by firms like Sony, Matsushita, MCA/Universal and Time Warner.

Yes, it may all be a long way down the road - but not as far as you think. Three years ago people were arguing there was a place for machines like the Spectrum and C64 in the market.

Soon, disk-based computers will be washed away by a tide of CD machines. And when you've got CD you expect a lot more than a combination of OK games and interesting packages. Home Computing is dead. Long live Home Everything! ☺

DYNAMITE WILL BLOW YOUR MIND

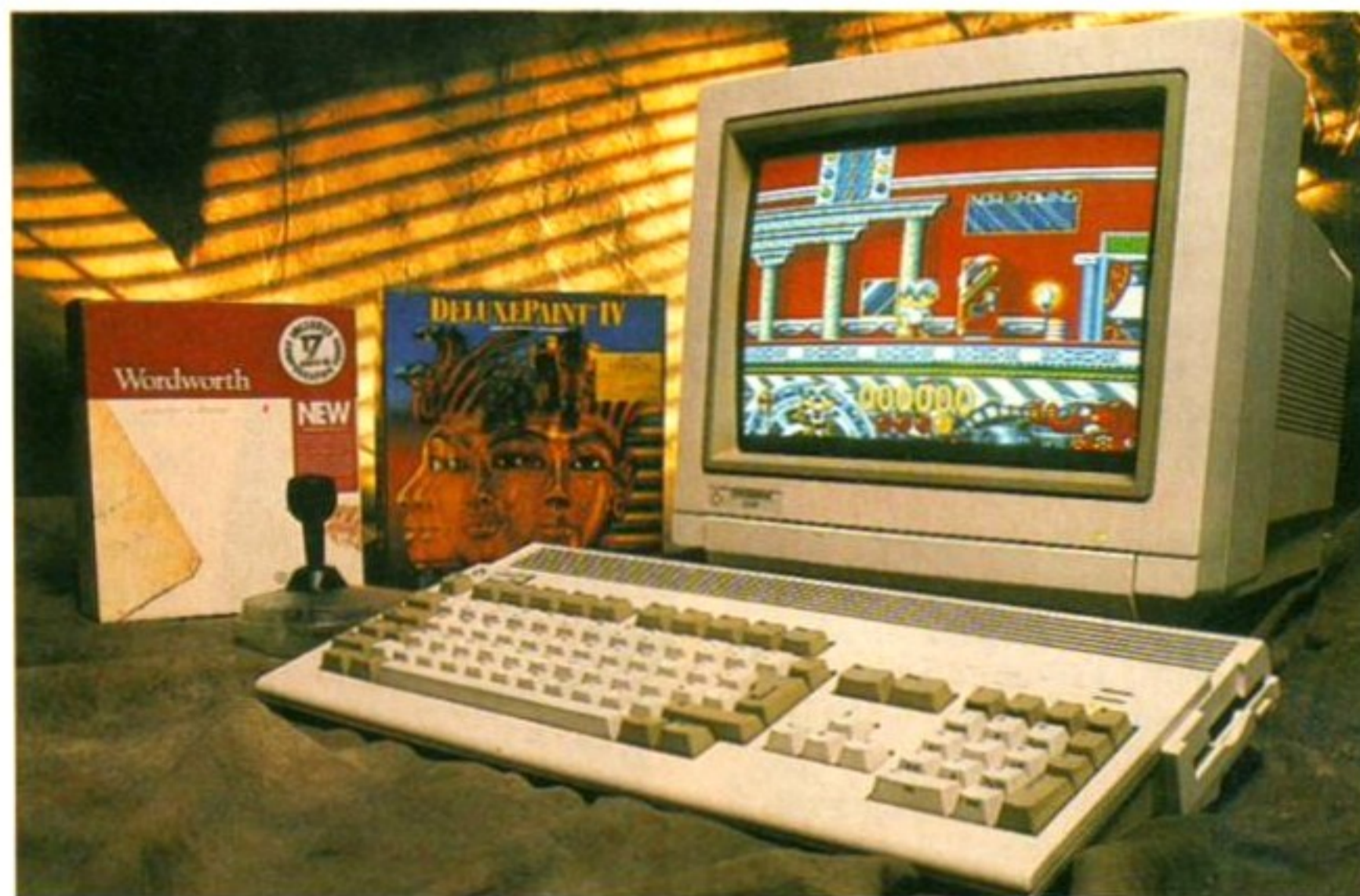

Commodore's new A1200 Desktop Dynamite bundle saves you more than £270 in software costs. The pack includes the A1200, two top-name games, *Wordworth 2 AGA* and *DPaint IV AGA* for £349.

THE NEW A1200 Desktop Dynamite bundle is described by Commodore's Marketing Manager for Retail Products, Jonathan Anderson, as the "best ever" package that the company has released. And he could well be right.

The bundle, which is targeted at the lucrative Christmas market, is an exercise in aggressive marketing aimed at confirming the A1200's position as the most popular home computer in Britain, according to Anderson.

The programs included with the A1200 are the *Wordworth 2* word processor (worth £129.95), Digita's *Print Manager* print enhancement program (worth £39.99), the *DPaint IV AGA* paint package (worth £99.95), and the two platform games *Oscar* (worth £25.99) and *Dennis* (worth £27.99). There's also a special edition of *Amiga Format* in every box.

All the programs are AGA versions, which means they take full advantage of the incredible graphics produced by the A1200's Advanced Graphics Architecture chip set.

The bundle costs £349.99, so, with the current price of the A1200 at £299, customers are only paying £50 for software worth more than £320.

Says Jonathan Anderson: "I have been with Commodore for four years and this is definitely the best pack we have done. *Wordworth* and *DPaint* are both industry standards, the games are very good and Digita *Print Manager* is an excellent print enhancement feature."

Since the A1200 price drop to £299, sales have rocketed, with two major High Street retailers selling 1,000 units a week over the usually slow summer months. This means that by the time you read this, sales of the A1200 will have risen from 97,000 to over 100,000.

With such an attractive bundle in place for the Christmas market, Commodore are obviously aiming to see off what remains of the opposition in the home computer market and send A1200 sales soaring even higher.

Commodore are planning two more bundles, both to accompany the new CD³² console. The first will feature a range of the current CD software, and the second will include Full Motion Video titles. ☺

GRAB YOURSELF AN XMAS PRESSIE!



At £2.99 each these games from Daze Marketing are a bargain that can't be beaten.

Daze Marketing have an early Christmas present for Amiga owners. They are releasing *Storm Master* (AF33 90%), *Metal Mutant*, *Crystal of Arborea*, *Boston Bomb Club* (AF28 74%), *SuperSki 2* (AF35 70%) and *Starblade* (AF15 67%) all at £2.99 each. This applies from now until new year's eve (when Daze will be down the pub), and only if you buy directly from Daze, 2 Canfield Place, London NW6 3BT.

NEWS brief

MORE SNASM

SNASM is a development system used by software companies when creating games for the Amiga. The new version was launched recently, and is even more flexible and powerful, so softies have no excuse for releasing anything but superb games from now on. Call Cross Products on 0532 429814.

LEARNING AMOS

AMOS in Education is a new book written to help programmers with AMOS. Priced at £12.95, the book is aimed purely at helping with the production of educational programs. AMOS is exceptionally good at these packages, and after the UK release of *Blitz Basic 2* this may be where it continues to succeed. Call 0734 844335 for details.

SHOW AHoy!

Spotlight Amiga is a one-day Amiga only show to be held at the Novotel in Hammersmith on 17 October. Get along there if you want to see product from Amiga distributors and retailers. There will be bargain gear on sale and experts on hand to answer your questions.

Doors open at 10am, and tickets cost £1.50. But the first 500 callers to the ticket hotline, quoting the number AF1 will get free tickets. Some of the AF team will be going along, so we might see you there.

IDE DRIVES

Media Source reckon they can supply 2.5-inch IDE drives cheaper than anyone else. Maybe it's true... write to PO Box 4, Bangor, Co. Down, BT19 6UP.

XTRA VALUE VLAB

One of the Amiga's finest frame-grabbers, *VLab* has fallen in price. Call Xi Electronics on 0383 881768.

HARLEQUIN TOO

The first, and some say best, Amiga 32-bit board, Harlequin, has been brought bang up-to-date. Harlequin Plus has an in-built genlock and additional display and output modes. 24-bit palette mapping allows real time adjustment of hue, saturation and brightness for colour balancing and fading. Expect a review in AF soon. Call Xi Electronics: 0383 881768.

NEW CLIPS

E M Computergraphics have 41 new volumes of IFF clip art to complement their already huge range of high quality fonts. They also have five new volumes of Adobe fonts, six of CompuGraphic fonts, two of colour fonts and 30 of 'stunning photorealistic 256 colour images for WB3/24-bit users'. Call Errol on 0255 431389 for full details.

THE AMIGA MAKES MORE MOVIES!

A new British outfit is all set to make a major motion picture using Amigas for the sci-fi special effects, as Marcus Dyson discovers...

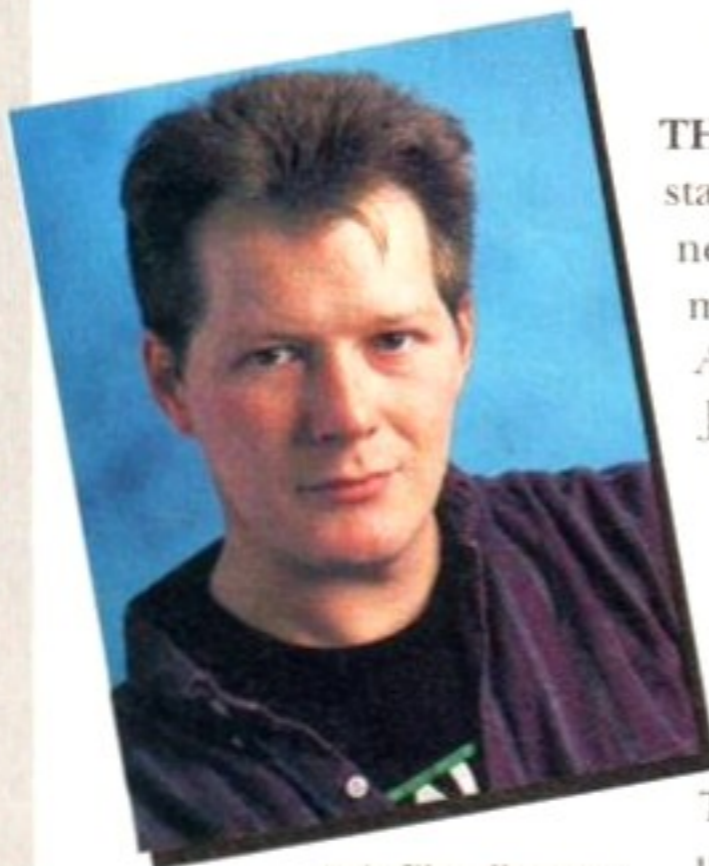

Brit film director John Allardice is about to make the Amiga a movie star.

THE AMIGA IS to take a starring role in a brand new British cyberpunk movie. Director and *Amiga Format* reader John Allardice realised his Amiga was the answer to his special effects headaches after reading our feature on *Babylon 5* in Issue 48.

The movie, currently under the working title *Wetware*, involves all the classic elements of a

William Gibson novel. As John explains: "It's got everything: grunge, bikers, the network and action. Lots of action! It's true cyberpunk".

John has made his living for the last nine years as a video freelancer. In April this year he started his own company, Shadowmaker, to produce music videos and do industrial and corporate video work.

Like many commercial video professionals, John had aspirations of producing a feature film. He also had a 'treatment' (filmese for script) that he and his associate Marc De Launey had been working on over the last year. So when they heard about Boxcar, an Edinburgh-based film company producing up-to-date, exciting, commercial British films rather than twee dramas about two people in the nineteenth century meeting and falling in love, he contacted them.

A meeting was set up with Boxcar and John showed their main man Jim Hickey a teaser he had shot in September '92, which had sat undeveloped until this June when John could finally afford the processing. The four short action sequences on the trailer were all shot in two afternoons on a budget of £400 using 'whoever was around at the time.' It, and the script, were good enough to convince Boxcar that *Wetware* was worth their cash.

Since all Boxcar's first six productions have budgets of under £500,000, keeping costs down is important to John if *Wetware* is to have the impact he wants. And one great way of creating all the graphics for the net sequences of his movie is to use Amiga 3D packages. John is an old hand at *Real 3D*,



The special effects for John Allardice's cyberpunk movie *Wetware* will be produced on an Amiga and even the video's cover was made using *OpalPaint*.

ICL: NO NEWS IS GOOD NEWS

ICL HAVE NOW begun to uphold their obligations under the new warranty and distribution deal revealed exclusively in *Amiga Format* last month.

The distribution network is already working efficiently with what little stock they have. Distribution of the CD³² started successfully in early September with units first finding their way to the shelves of Rumbelows. It's just a shame the software houses hadn't managed to get any games there too.

The key to ICL's success where lesser beings have failed will be the warranty question, which has proved to be the Achilles heel of Commodore's operation since the FMG fiasco back in '91.

However, ICL seem more than equipped to deal with the problem. Their Wakefield call reception centre, which also caters for their thousands of

corporate clients, has a record of answering 98 per cent of calls within three seconds. It's not just a question of answering the calls either. If necessary, problems are logged and passed on through a vast network to ICL service centres throughout the country where trained engineers analyse them.

The service terms for the new CD³² machines are if it breaks you send it back and they will return it fixed within 10 days; A1200 owners will get a visit within four working days; and lucky A4000 owners get a next-day visit.

The service lines, which are in operation from 8am to 8pm Monday to Saturday, became operational on 1st September. David Palk, general manager of the system service division says: "Things are going swimmingly well..."

having used it for his video work. But he wanted to take a look at the Video Toaster *Lightwave 3D* package before he made up his mind (discover more about it on Page 36). But after initial discussions with Ron Thornton (of *Babylon 5* fame) John is sure the Amiga is the answer to his prayers.

Another reason the Amiga appeals is price. As John explains: "I got the local Mac guy in, and he came up with a quote. One Quadra 950, peripherals and software would have taken the entire special effects budget of the movie. I can afford two A4000 Toaster set-ups for less."

John's plans for the Amiga's involvement in the movie don't stop with just ray tracing. "We might be doing some digital compositing [combining images] with computer graphics and live action on the Amiga, that would be a world first," he says. "Once the Screamer [an accelerator for the Toaster which uses two RISC chips in parallel for amazing speed] is available, it will be twice as fast as a Silicon graphics Iris workstation. *The Last Starfighter* was done on a Cray One - a Screamer Toaster should be twice that fast..."

Not only will the film owe its existence to the Amiga, but if John gets his way *Wetware* will appear on CD³² too. Shadowmaker are seeking a computer software house to convert *Wetware* to a game.

"This kind of action movie would be ideal for CD games," John urges. "The timing is just right, we're just about ready to start talking about a computer game at the time Commodore have announced FMV. We have the ability and we're prepared to shoot footage especially for the game. You know, stuff where the stars do direct to camera dialogue and things like that. So anybody interested in doing the game would be involved from ground level."

We've seen the script, and *Wetware* is the film that we here in *Amiga Format* have been wanting someone to make for years. "If all goes according to plan, we'll be releasing *Wetware* into the cinemas round about October next year - we can't wait for it to be finished. We will have the dubious distinction of producing the first 18 certificate ever to come out of Scotland... it certainly won't be Disney!" concludes John.

Any Amiga artists or animators who think they might have something to offer *Wetware* should contact John Allardice on 0369 5185, as should any games houses who think they can do justice to this film. ☺

A SPECIAL GAME

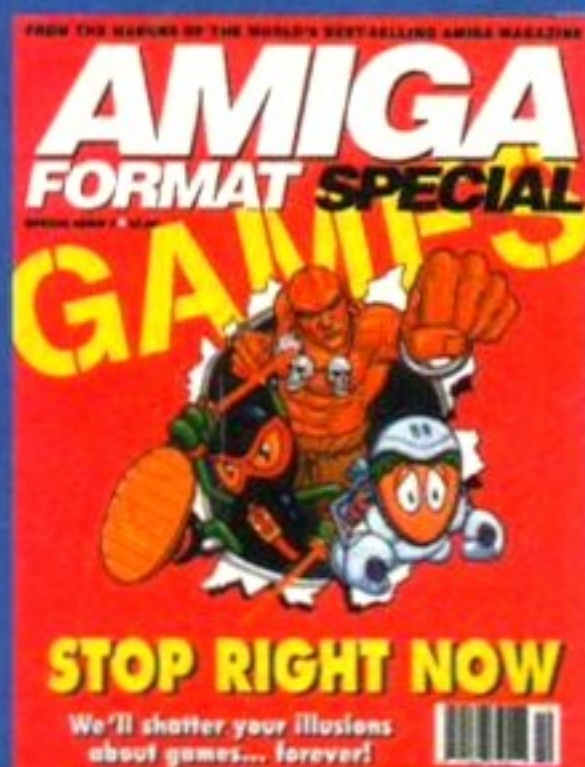

THOSE FABULOUS PEOPLE at *Amiga Format Special* have just released their latest offering, *The Games Special*. Crammed with interviews of all the movers and groovers in the software circuit, in-depth background articles on the making of your favourite games and exclusive previews of games to come it's

STOP RIGHT NOW
We'll shatter your illusions about games... forever!

The AF Games Special - it's a must and it's out now!

a must for the serious gamer. Look out for the *Blitz Basic* section inside that complements our Coverdisk. All of this and the chance to win a CD³² or all of Team 17's back catalogue. Don't miss it!

The second Future Entertainment Show

WISE UP AT THE WORLD OF AMIGA!

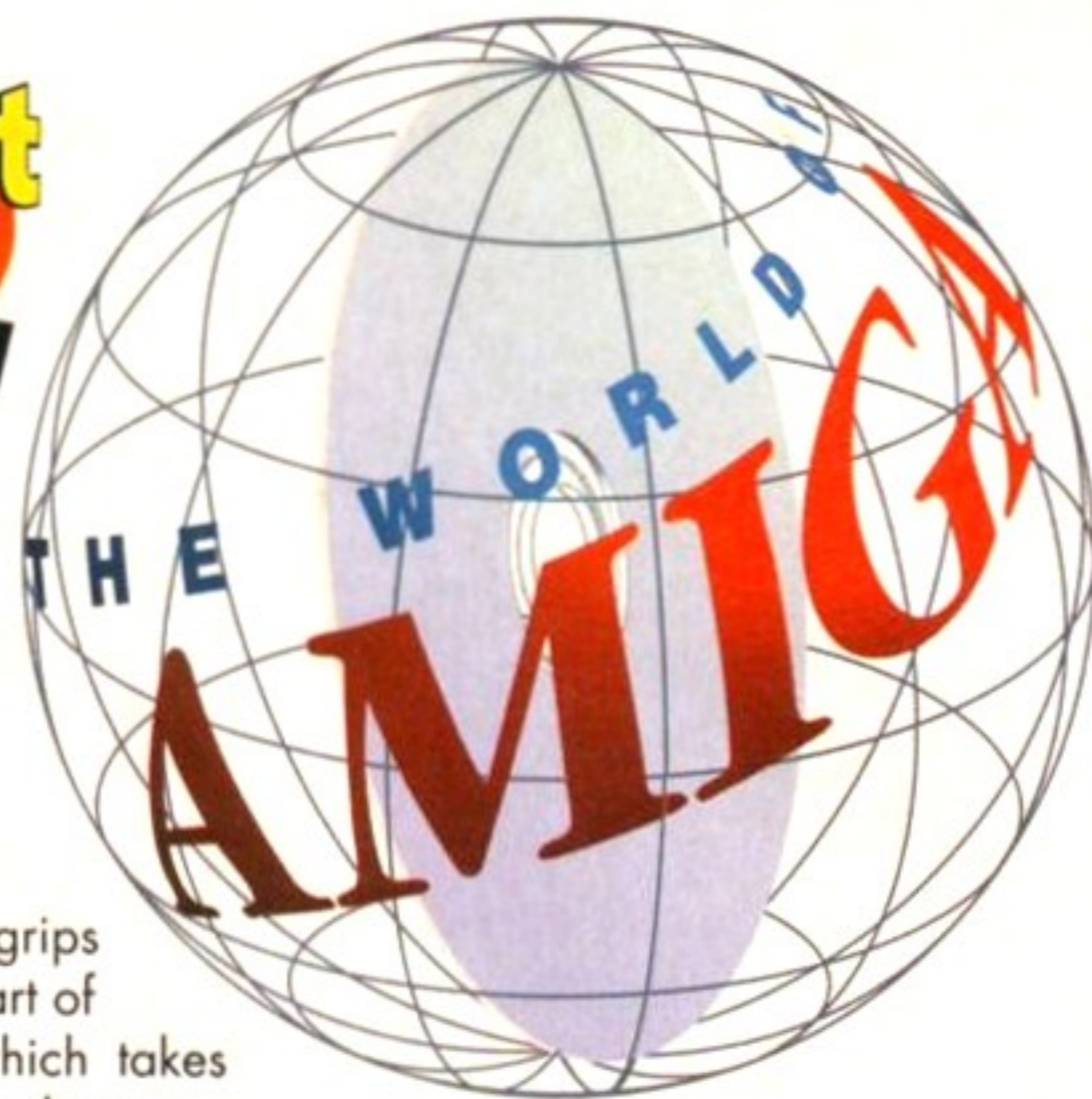

All things Amiga will be gathered in one place just for you to get to grips with at **The World of Amiga**, part of The Future Entertainment Show which takes place at Olympia on 11-14th November.

Whatever you're interested in, be it games, graphics, music or more serious stuff, software houses and hardware manufacturers will be there with bargains abounding. Advice will also be at hand from the experts and, of course, the staff from every one of Future Publishing's Amiga magazines - *Amiga Format*, *Amiga Power* and *Amiga Shopper* - will be hanging around to answer questions and help you out.

Last year's Future Entertainment Show was a huge success and this one promises to more than match it with special attractions and competitions happening each day. But be warned: tickets are not on sale at the door - you must buy them in advance. They cost £6.95 each or £24.95 for a group of four and can be ordered by ringing the telephone hotline on the number below...

FES HOTLINE 051-356 5085

AMIGA NEEDS DRIVERS



THERE ARE MANY wonderful niche market printers out there looking for Amiga drivers. Take the Seikosha Smart Label Printer Pro, for instance. This tiny unit outputs high-quality text on to labels for mailshots and is ideal for a number of applications, even for sending out your Christmas cards if you're very popular. But though any computer can drive any printer, it's a driver, or the lack of one, that makes this beastie inaccessible to Amiga owners. Anyone out there feel like writing one? For more info on this cute label device call Seikosha on 0756 701263.

Seikosha's Smart Label Printer Pro. It may be smart, but until someone writes a driver it's no use to Amiga owners.

WINQUECENTO!



Special Reserve, those renowned mail order purveyors of cheap computer games, are running a special competition every two months with prizes totalling over £10,000.

This month's big star prize is a Fiat Cinquecento. This superb motor is powered by a 899cc engine and has a 0-60 time of 18 seconds. Special Reserve is a club; membership can be obtained by dialling 0279 600204.

The quintessential Cinquecento could be yours if you're on the Special Reserve list.

THIS MONTH'S TOP 30



1(3)	▲	Syndicate	FG 91%
		Electronic Arts	
2(1)	▼	Gunship 2000	FG 94%
		MicroProse	
3(-)	New	Dune 2	FG 90%
		Virgin	
4(2)	▼	Goal!	88%
		Virgin	
5(5)	■	Graham Gooch Cricket	78%
		Audiogenic	
6(4)	▼	Champ Manager '93	82%
		Domark	
7(10)	▲	Sensible Soccer 92/93	80%
		Renegade/Mindscape	
8(7)	▼	Desert Strike	87%
		Electronic Arts	
9(6)	▼	Flashback	FG 93%
		US Gold	
10(28)	▲	F1 Grand Prix	FG 92%
		MicroProse	
11(9)	▼	Body Blows	87%
		Team 17	
12(11)	▼	Premier Manager	87%
		Gremlin Graphics	
13(-)	New	Blade of Destiny	FG 91%
		US Gold	
14(15)	▲	Lemmings 2	FG 94%
		Psygnosis	
15(13)	▼	Space Legends	FG 91%
		Empire	
16(-)	▼	Reach For The Skies	FG 90%
		Virgin	
17(17)	New	Ishar 2	79%
		Daze/Silmarils	
18(14)	▼	A-Train	84%
		Ocean	
19(12)	▼	The Chaos Engine	FG 90%
		Renegade/Mindscape	
20(19)	▼	Streetfighter 2	87%
		US Gold	
21(25)	▲	Monkey Island 2	FG 95%
		US Gold	
22(26)	▲	Wing Commander	83%
		Origin/Mindscape	
23(23)	■	Civilization	FG 94%
		MicroProse	
24	New	Battle Isle '93	81%
		Blue Byte	
25(16)	▼	Walker	81%
		Psygnosis	
26(-)	Re	Chuck Rock 2	81%
		Core Design	
27(-)	Re	Sim Earth	79%
		Maxis/Ocean	
28(-)	Re	Nick Faldo's Golf	FG 90%
		Grandslam	
29(22)	▼	Indy Jones - Atlantis	FG 92%
		US Gold	
30(29)	▼	PGA Tour +	FG 90%
		Electronic Arts	

CD³² AT £14.99



Alien Breed is a popular modern classic. It's now available on CD³² for the bargain price of £14.99. Buy it!

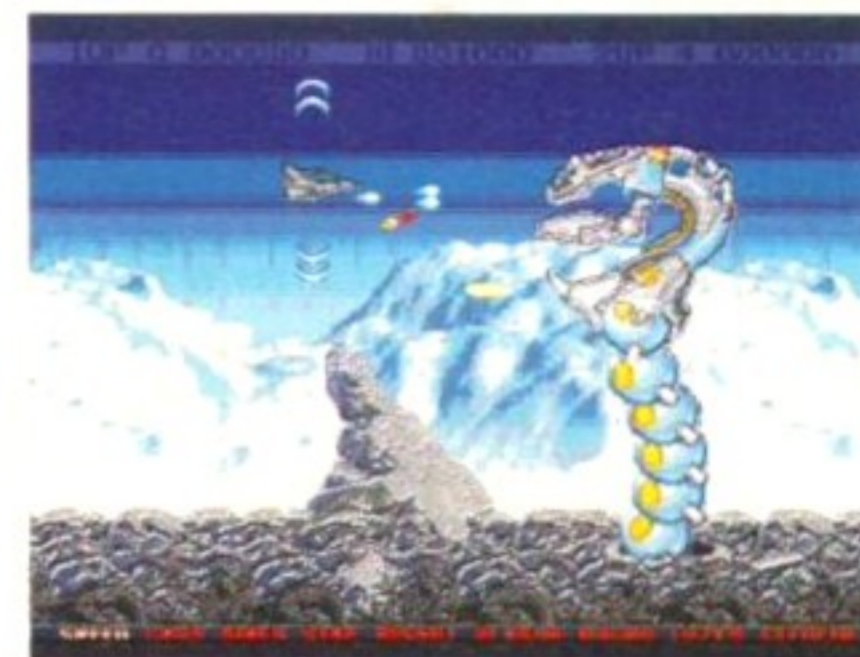

Project X is another popular modern classic. It's also now available on CD³² for the bargain price of £14.99. Buy it!

Wakefield based software supremos Team17 like the CD³², but they won't have any new product ready for release on the format until early next year – so they are about to release several of their old favourites on CD at a budget price. Look out for *Project X*, *Alien Breed*, *F17* (reviewed on Page 104 of this issue) and *Quack* in the shops from the middle of October at a price of £14.99. *Quack* is so new that it won't even be reviewed until next issue. But Paul of Team17 says: "We've been playing it in the office for months, which is quite amazing because we usually get bored pretty quickly".

Well done to the Wakey boys for putting their price-points where their mouths are and releasing the very first lower-priced commercial CD³² stuff.

MICROPROSE MERGE WITH SPECTRUM HOLOBYTE



Famous for games like *Formula One Grand Prix*, MicroProse's future now seems secure.

Following months of speculation about their finances, MicroProse have announced plans to merge with US-based adventure game specialists Spectrum Holobyte.

The deal was announced at a special press conference in Bath by Rob Davies, MicroProse's group marketing director. This followed mounting concern about the company's future and a swathe of world-wide redundancies.

Despite heavy investment MicroProse got into financial difficulties last year following a series of failures in the US games market. Highly successful European titles like *Formula One Grand Prix* failed to capture the American public's imagination, while development costs for new games spiralled beyond a point where MicroProse could recoup the money.

By merging with Spectrum Holobyte, MicroProse are confident their flight and strategy sims can now reach a wider audience in the States, while Holobyte's range of adventure and platform games should receive a higher profile in the UK and Europe.

Perhaps the most significant move is a \$10 million cash injection into MicroProse by their US counterparts – this has enabled MicroProse to announce an ambitious range of games releases for 1994 including a CD³² version of *Impossible Mission*. Other Amiga releases like *Subwar 2050* and *Starlord* are likely to be on A1200 and CD³² formats only.

E.D.O.S. ZONE



Finding the Amiga software you want is now made easier at Future Zone stores – everything's accessed from a hard drive.

Fast growing computer store chain Future Zone is to implement the E.D.O.S. system (Electronic Distribution of Software) in the majority of their stores. The system involves keeping thousands of games on a huge hard drive, and then duping them off on to disk as demand requires. Future Zone have hundreds of Amiga titles, most of them re-issued or budget games.

DIGGERS

A UNIQUE GAME OF DISCOVERY AND EXPLORATION

95% CD 32 version
Gamer Gold
Amiga Computing

*'Diggers is the hit of the year!
...the game is going to be
absolutely massive'*

*'...the best I've seen in a long
time and it will take the rest
of your life to complete it'*

92% CD 32 version
Amiga CD
Magazine

*'It's hard to see another
strategy game giving this a
black eye for quite a while'*

OUT NOW FOR THE A1200
CD VERSION AVAILABLE EXCLUSIVELY
WITH THE AMIGA CD32 CONSOLE

Four races of unruly diggers converge on the Zargan Mining Centre, tense with anticipation - for tomorrow is the start of one month's frenzied digging activity. Treachery, sabotage and amazing discoveries lie ahead. Have you got what it takes to lead a team of Diggers into the mining labyrinths of the planet Zarg? If you can reap the planet's rich rewards and beat your ruthless opponents then fabulous treasures await you.

- A huge game of exploration and discovery
- Million different locations
- 30 humungous levels
- 4 digging races to choose from, each with distinct character traits
- Powerful computer intelligence giving each digger independent actions
- Build huge labyrinth tunnel systems
- Break the Zargan Bank!



Millennium, Quern House, Mill Court, Great Shelford, Cambridge, CB2 5LD Tel: 0223 844894



NEWS brief

MAKING SENSE

Chambers Harrap Publishers have just released a book called *Making Sense of English In Computers* and it is, basically, a computerese dictionary. For example:

Worm: 1. A program that can replicate itself and spread from computer to computer over a network, usually in order to cause damage to files. Unlike a virus, it does not attach itself to other programs. See also Trojan Horse. 2. An acronym for Write Once Read Many times used of optical disks and other storage devices.

Pretty good, eh? We'll review it next month, but if you need computer interpretations before, call 031-557 4571.

GET ANIMATED

If you want to give computer animation and graphics a go, why not try Hammersmith and Fulham's Community Media Project? They're running a course on 20-21 November. Call 081-741 1766.

FAME AT LAST!

John Atkinson of Technical Dimensions wants to make Amiga musicians famous. He uses his Amiga to power a recording set-up with which he records local choirs and bands, and plans to release an album of Amiga music, featuring around 12 pieces of techno/rave/hardcore music. Send your demos or disks to: Technical Dimensions, 32 Midway, Walker, Newcastle Upon Tyne, NE6 3PA, or call 091-263 7971.

GAMES RATED

The games industry has finally decided that computer games should have movie-type ratings. European Leisure Software Publisher Association members have become registered members of the Video Standards Council. The decision has been hastened by FMV and the digitised footage in the Mega Drive game *Night Trap*. Most games will remain exempt, but to get into the spirit of things we've voluntarily given *Zombie Apocalypse* on this month's Coverdisk a 15 rating.

FACTS OR THEORY?

Parents worried about the effects video games are (allegedly) having on their children can get a new fact-sheet.

The National Council for Educational Technology is trying to sort the truth from the bull on subjects like epilepsy and if computer games rot your brain or improve logic, plus other such matters of importance. We'll give this document the once over when we can get a copy.

HP SOURCE

Dixons are to become the main High Street retailer for Hewlett Packard computer products. Most important to Amiga owners will be the DeskJet 500C and LaserJet printers.



A NEW AMIGA VISION?

This October sees the Amiga taking part in a show which is sure to fill the National Hall at Olympia. Vision '93 is a spin-off from The Television Show aimed at professional video makers and though this is the first year of the show, it is attracting major interest from dealers and corporates, including Amiga developers. One of the highlights is sure to be the official launch of the Video Toaster 4000, in conjunction with Prime Image and Vortex.

Other potential Amiga exhibitors include Amiga Centre Scotland, Scala and Satlink. Tickets will be £15 on the door or you can contact Vision Exhibitions Ltd on 081-948 5522 for advance booking details.

Video Toaster 4000 - its first official launch will be at Vision '93 in October.

BARGAIN TIME AGAIN



If 16-bit technology is enough to keep you content then there's plenty of bargains to be picked up from mail order dealers Indi.

The advent of 32-bit Amiga technology has led to bargains galore for Amiga buyers content with 16 bits and now Indi Direct Mail have two incredible buys on special offer. The Amiga 1500 with twin 3.5-inch drives and a pack of software including *Deluxe Paint 3*, a word processor and some games will rush you a mere £350. This represents an absolute bargain for anyone wishing to use an accelerator and 24-bit card.

The CDTV multimedia pack is also on extra-special giveaway price offer. A CDTV, keyboard and external disk drive will cost you just £229.99. Call Indi on 0543 419999.

NOW THAT'S WHAT I CALL GAMES

...is the title of a new compilation but not, as you might expect, a compilation from Ronco or K-Tel containing all the worst games of the last year.

It is in fact from MultiMedia Machine of Bolton in Lancashire, comes on CD and contains 100 PD and shareware games, 50 of which are tested and work on CD³².

The rest work on various combinations of CDTV, A570 and the planned upcoming A1200 CD drive. All were tested by MM proprietor JayBee's grandchildren, and have a friendly front-end and loading system.

All this unbridled fun is not without its price, and that price is a mere £19.99. So if you fancy playing *DriveWars*, *Mega Race*, *Weltrix*, *Crazy Pipes*, *TomCat*, *Copper* or any one of 94 other games, call MultiMedia Machine on 0204 363688.

VIDEO WARS

Pride International have a direct competitor to the VideoPilot video editing hardware featured in the last issue of *Amiga Format*. The PIV 2001 shows its American origins by being an internal device for 'big box' Amigas, but otherwise it boasts a similar set of features to V3i's nifty external unit. Call Pride on 0793 514055 for more details, or read the review soon *Amiga Format*.

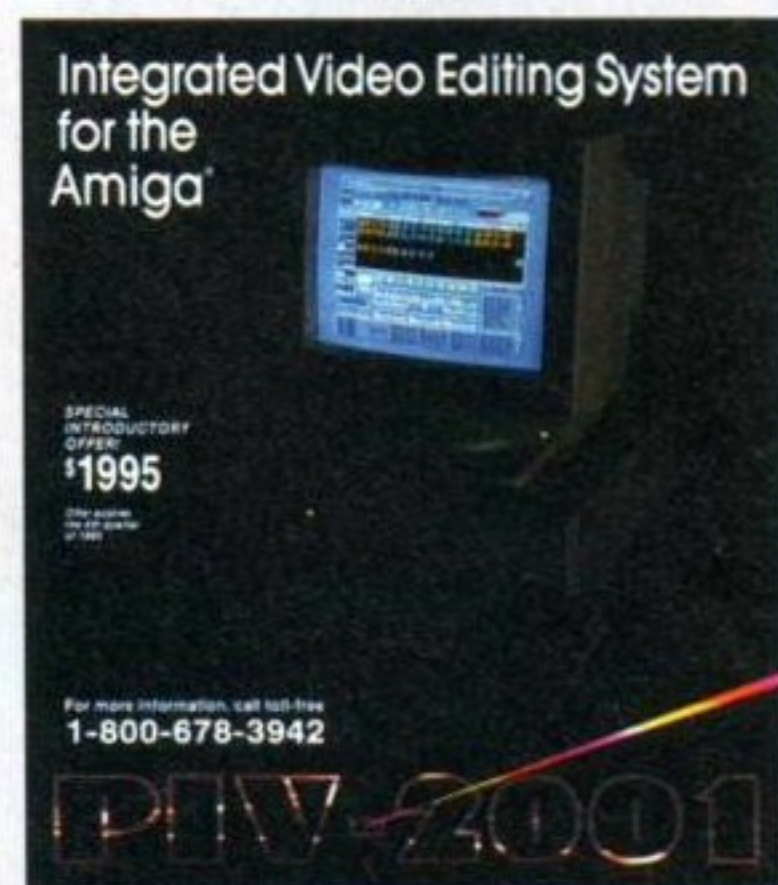

All the way from America, PIV 2001 is set to give VideoPilot a run for its money.

CLARISSA RENDERS ANIMATIONS SMOOTHER

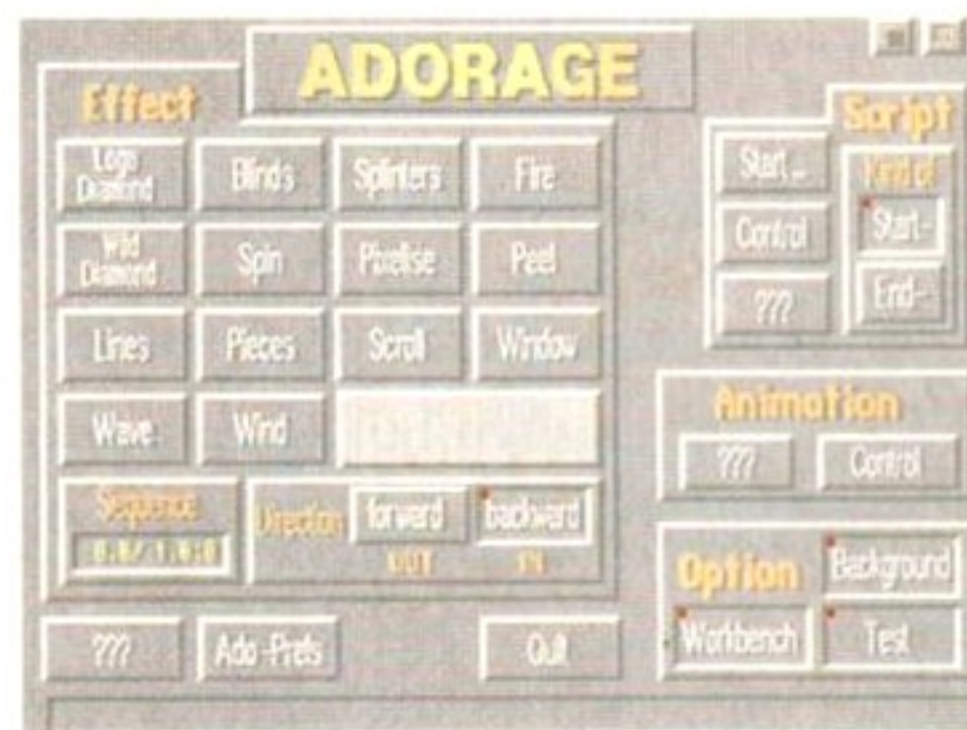

Until Clarissa there was no way of editing animations in the excellent SSA format used by Adorage.

Clarissa is a new animation effects package from Micro-PACE UK. It has long been available in Germany, and has finally been translated for UK use. The £79.99 package has a host of features including a virtual memory facility that enables animation far larger than available RAM to be manipulated. Its frame-grabber can capture screens from other programs multitasking alongside it and import them directly into the animation being worked on, and Clarissa saves in the superb Super Smooth Animation format that made Adorage so useful. Call Micro-PACE UK on 0753 551888 for full details.

OKI'S OK PRICES



OKI, manufacturers of the *Format* Gold-winning OL810 printer, have reduced prices across their eight pages per minute LED printer range. The reductions are in the region of 33 per cent on each machine. Call 0753 819819 for more details.

MORPH MADE FASTER

Owners of the truly incredible Vivid 24 high-speed graphics board can use its amazing power to do some pretty high-speed morphing too.

Warp 10 (*Star Trek* gag alert!) is a new piece of software designed to do what *Morph Plus* does, only faster. It can operate on images of up to 32768 pixels square... that's big!

COLOUR PRINTING AT A GREAT PRICE!

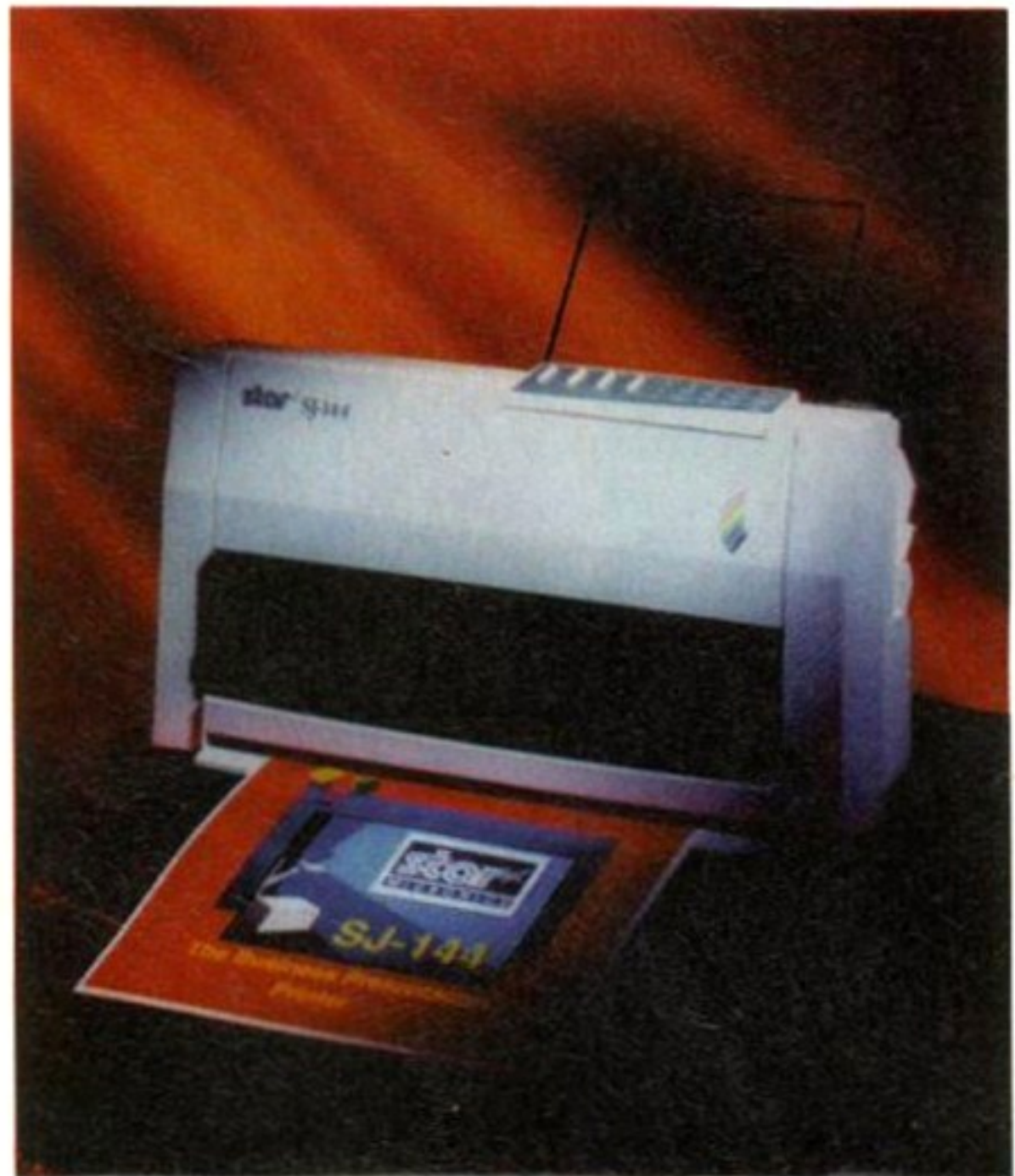

Colour thermal printing at an affordable price? You'd better believe it - manufacturers Star Micronics are about to bring us a great buy.

Thermal printers can offer very good quality printouts at reasonable prices, unless it's colour you want. Colour non-impact printers are notoriously expensive, but Star Micronics are about to launch a colour thermal printer which they claim is affordable. And it is too. The recommended retail price of £569 plus VAT (£669) will make it one of the most competitively priced quality colour printers around.

That's not the only good news - Star are currently working on a dedicated Amiga driver for the machine which should be completed by early October. Expect a review in *Amiga Format* as soon as the machine is available.

SSSSHHHHHH!!!!



The KX-P2023 is Panasonic's latest addition to the Quiet Printer range and comes with an Amiga-specific driver.

Panasonic have a new addition to their extremely quiet range of printers, known cryptically as Quiet Printers. The KX-P2023 is a narrow-carriage 24-pin dot matrix printer. The suggested retail price is a mere £240 plus VAT (£282 to all you non self-employed). Panasonic have joined the legion of printer manufacturers who are now offering Amiga-specific driver software to use with their machines, and their Amiga Driver is free with all their

Quiet Printers. If you have already bought a QuietPrinter call 0800 444220 for a driver. KX-P2023 buyers will receive a free sheet feeder too. Call Panasonic on 0344 853915.

CD³² COMPATIBILITY EXPLAINED

Capri CD Distribution have untangled the web of compatibility between CD³² (the great machine with no software) and CDTV (the not quite so great machine with lots). They say the following CDTV titles will work with CD³², with the relevant limitations...

EDUCATION

A Bun for Barney
A Long Hard Day at the Ranch
Asterix French for English 1&2
Asterix English for French 1&2
Barney Bear Goes Camping
Barney Goes to School
Cinderella
Fun School 3
Heather Hits a Home Run
LTV English
Moving Gives me a Stomache Ache
My Paint
North Polar Expedition
Scary Poems for Rotten Kids
Tale of Benjamin Bunny
Tale of Peter Rabbit
Thomas's Snowsuit



ENTERTAINMENT

Air Warrior
All Dogs Go To Heaven
Asterix and Son
Battlestorm



CDPD 1, 2 & 3*

Defender of the Crown
Demo Collection 1*
Dinosaurs for Hire
Fantastic Voyage
Fractal Universe
Global Chaos
Hound of the Baskervilles
Pandora's CD*
Prehistorik
Psycho Killer
Sim City
Snoopy and the Missing Blanket
Tie Break Tennis
Town With No Name
Trivial Pursuit
Xenon II



ARTS AND LEISURE

Advanced Military Simulator
Animals in Motion
Connoisseur of Fine Arts
Gardenfax: Fruits and Vegetables



Gardenfax: Indoor Plants
Gardenfax: Trees and Shrubs
Guinness Disk of Records
Women in Motion
Musicolor



REFERENCE

American Heritage Dictionary
Illustrated Works of Shakespeare
Dr Wellman
Illustrated Holy Bible
New Basics Electronic Cookbook
Timetable of Business and Politics
Timetable of Science and Innovation



BUSINESS

Inter Office

KEY

Joystick compatible 🎮 Needs mouse 🖱️
Needs CD³² keyboard ⌨️
Needs keyboard and disk drive 🖨️
* Keyboard/disk recommended
SFX Slight sound fault is evident

If you would like to buy these, or any other CDs, call Capri on 0628 891022.



FIRST COMPUTER CENTRE

OPEN 7 DAYS A WEEK
OPEN MON - SAT.....9.30AM-5.30PM
SUNDAY OPENING.....11.00AM-3.00PM
THURSDAY NIGHT LATE...9.30AM-7.30PM
MOST BANK HOLIDAYS..11.00AM TO 3.00PM

PREFERRED DEALERS FOR
ACORN, CITIZEN, COMMODORE, DIGITA, PACE, PRIMA, SEGA, STAR ROMBO, SUPRA, US ROBOTICS

HOW TO ORDER

Order by telephone quoting your credit card number. If paying by cheque please make payable to the:

"FIRST COMPUTER CENTRE."
In any correspondence please quote a phone number & post code. Allow 5 working days for cheque clearance

● interest credit available!
Please phone for details

- All prices include VAT
- All hardware/computers are UK spec.

UK MAINLAND DELIVERY TARIFFS

- Standard Delivery.....£1.00
- Guaranteed 2 to 3 day (week days) Delivery.....£2.50
- Guaranteed Next Day (week days) Delivery.....£4.90
- Open seven days a week
- 1200 sq. ft. showroom
- Free large car park
- Overseas orders welcome

FULL REPAIR SERVICE

We offer a **FREE** quotation on your computer or any peripheral (monitors, printers etc.). A delivery charge of just £5.00 is charged or alternatively you can visit our showroom.

SALES & TECHNICAL

24 HOUR MAIL ORDER SERVICE 6 LINES!

0532 319444

FAX: 0532 319191

FOR DESPATCH & RETURNS ENQUIRES TEL. 0532 637988

SHOWROOM ADDRESS:

DEPT. AF, UNIT 3, ARMLEY PARK COURT, OFF CECIL ST, STANNINGLEY ROAD, LEEDS, LS12 2AE.

(Follow A647 signs from Leeds City Centre)

It is recommended that prices are confirmed before ordering goods



2% surcharge on AMEX

AMIGA 1200 RACE & CHASE PACK

£289.99!

NOW WITH NIGEL MANSELL F1 AND TROLLS!

HARD DRIVE VERSIONS

20Mb.....£379.99
85Mb.....£499.99
209Mb.....£599.99

The New Amiga 4000/030

Based on the 68030 processor. Complete with hard drive & 2Mb of chip RAM & WB3

only £909.99 for 80Mb version or £969.99 for 120Mb version

Amiga 4000/040 from £1939.99

with 6 Mb RAM and 120 Mb hard drive

Cartoon Classics Pack.....£194.99

with Lemmings, Captain Planet, The Simpsons & D-Paint 3

AMIGA 500 Deluxe only £239.99

with built in ROM sharer 2.04/1.3

AMIGA 600 Basepack now with X OUT game (LIMITED OFFER)

only £194.99!

AMIGA 600 20HD The Epic pack 20 Mb Hard drive, Epic, Rome, Myth, & Trivial Pursuit, Dictionary, Language Lab & D. Paint 3

only £289.99 (Inc On Site Maintenance)

The A600 Wild, Weird & Wicked inc Micro Prose Grand Prix, Deluxe Paint 3, Putty & Pushover Plus "X OUT" shoot em up

only £219.99

A600 DELUXE.....ONLY £245.99

A600 20HD DELUXE.....ONLY £339.99

inc. ROM sharer with 1.3 & 2.04 ROM's making incompatibility a thing of the past. The A600 HD Deluxe comes with a Built in 20 Mb hard drive

Just add 32.99 for a 2 Mb 600 Deluxe!!

PRIMA A1200 REAL TIME CLOCK

at last now you can date and time stamp your files Fits directly onto the motherboard with no soldering.

now only £14.99!

check for compatibility

A600 & 1200's HD kits

Add £14.99 for Real Time Clock!

20Mb.....*£89.99 60Mb.....*£179.99
80Mb.....*£195.99 127Mb.....*£269.99
210Mb.....*£369.99 *Just Add £10.00 for fitting

All Amiga's come with Workbench, mouse & 12 month warranty. The A600's, A1200 & A4000 come with 12 months on site warranty All 1200/600's also come with a built in integral hard disk option.

THE AMAZING ZOOL PACK!

- ZOOL (97% Amiga Computing, Nov 92)
- STRIKER (94% CU Amiga, June 92),
- PINBALL DREAMS (94% AUI, Sept 92)
- TRANWRITE word processor

only £29.99
only £19.99 with any AMIGA!

NEW! AMIGA CD32 PACK

based on the 68020 processor, the CD32 features AA chip set, A4 size footprint, 2Mb RAM, 128K flash memory, built in WB & the ability to play normal audio CD's

only £289.99

CD Rom Amiga A570

Turns your Amiga 500 into a CDTV. Includes Fred Fish CDPD disk & Sim City

now only £147.99!

PRINTERS

All our printers are UK spec.

Canon FUJITSU HEWLETT PACKARD CITIZEN STAR

All our printers come with ribbon/toner, printer drivers (if available), paper & cables!!

CANON

NEW! Canon BJ10sx.....£224.99
Laser quality output. Large buffer

NEW! Canon BJ200.....£319.99
3 page a min speed, 360 dpi, small footprint & 80 page sheetfeeder

NEW! Canon BJ230.....£379.99
wide carriage version of above

Canon BJ300.....£419.99
Desktop bubble jet with laser quality

Canon BJ330.....£464.99
Wide carriage version of the BJ300

BJ10 Autosheetfeeder...£52.99
Canon BJ10 cartridge.....£18.99

CITIZEN NEW LOW PRICES!

Citizen printers have a 2 year guarantee

Citizen Swift 90 Colour.....£169.99
Excellent value 9 pin colour. Highly recommended

Swift 200 Colour.....£219.99
Same out put as the 240 but with less facilities

Swift 240 Colour.....£269.99
24 pin, 240cps draft, 10 fonts, quiet mode, 240cps.

FUJITSU

12 month onsite included except DL-1150 (12 month B T Base)

Fujitsu DL-1150 Colour.£274.99
24 pin, 10 fonts, 200 CPS

Fujitsu Breeze 100.....£219.99
ink jet, draft & LQ mode, BJ10EX beater

Fujitsu Breeze 200 ink jet.....£309.99

HEWLETT PACKARD

HP Deskjet Portable..only £369.99
New! HP510 mono.now £262.99
HP 500 Colour.....now £319.99
HP 550 Colour.....now £519.99

4 times faster than the HP500C!!

HP500 mono cartridges.....£14.99
Double life 500 cartridges.....£24.99
All HP printers come with a 3 year warranty

STAR

StarLC20.....£132.99
180 cps draft, 45 cps NLQ, quiet mode and multi fonts, push button operation.

StarLC100 colour.....£155.99
9 pin colour, 8 fonts, 180 cps draft, 45 cps NLQ

StarLC200 colour.....£195.99
9 pin colour, 8 fonts, 225 cps draft, 45 cps NLQ, A4 landscape printing.

NEW! Star LC24-20 MKII.....£224.99
24 pin quality, 210 cps draft, 67 cps LQ, 39K buffer expandable to 48K, 10 fonts and quiet mode.

Star LC24-200 colour.£264.99
Colour version with 30K buffer expandable to 62K

Star SJ48 Bubble jet.....£217.99
Laser quality, ultra quiet, Epson compatible & portable

NEW! Star SJ144 Colour Thermal
Stunning affordable colour printer. 3 PPM, low running costs

only £534.99

Star SJ48 Autosheet feeder.....£49.99
Star SJ48 cartridge.....£18.99
Star SJ144 cartridge (pack of 3).....£42.99
Star SJ48/BJ10 Refill kit.....£11.99

Laser Printers

on-site warranty standard

Fujitsu VM600 Laser.....£679.99
6 pages per minute, HP emulation, multi font, 300Dpi

HP Laserjet 4L.....£609.99
1 Mb RAM, 4 ppm, small footprint

OKI 400e.....£514.99
4 page laser, multi font, 512k memory, HP emulation

Ricoh PCL5.....£809.99
400 Dpi, 2Mb RAM, 5Page per minute
add just £114.99 for 2 Mb of extra RAM

Star Laserjet LS5.....£564.99
5 page laser, HP emulation, multi font, 300Dpi

MONITORS

All our monitors are UK spec. All monitors come complete with a free Amiga lead

PHILIPS CM8833 MK2 Colour
Colour stereo monitor. 600*285 line resolution, green screen facility, one years on site maintenance.
with Lotus Turbo Esprit!
now only £194.99 UK Spec.
Philips Tilt & Swivell stand ..£13.99

PHILIPS TV Tuner for the 8833.£64.99

Commodore 1084ST Colour
features built in tilt & swivel stand this new colour monitor from Commodore is outstanding value

only £199.99

MITAC SVGA .28 dp Colour monitor with overscan

only £249.99

NEW! COMMODORE 1940
Dualsync, .39 dpi **only £284.99**

NEW! COMMODORE 1942
Dualsync, .28 dpi **only £379.99**

COMMODORE 1960
multisync .28 dpi **only £379.99**

MICROVITEC MULTISYNCS

A 3 year warranty comes as standard

14".....£409.99
20".....£1099.99

Goldstar TV/Monitor..only £169.99
14" MONITOR COVERS.....£5.99

SUPRA MODEMS

The Supra-Fax Modem V.32 bis (14400 BPS !!!)

Allows you to send and receive fax messages. This new modem from Supra has full 14400 baud capability. Spec includes V.32bis, V.32, V.22bis, V22, V21, MNP2-5, V.42, V42bis, Class 1 & 2 commands, 9600/14400 Group 3 Fax. Includes free comms s/w & modem cable

only £249.99
New! Supra Fax V32Bis 14400lc

as above but no LED display and class 1 only

only £174.99
Supra Fax Plus

With the ability to send faxes! Even faster than the standard 2400 from Supra with auto dial & auto receive. Hayes comp. V22b, V42 Bis, MNP 2-5 & auto adjust to maximise transmission speeds. Includes free modem cable & comms s/w!!

only £119.99
GP FAX SOFTWARE only £39.99
if bought with modem
Supra 2400

Get on line using this great value fast modem with auto dial & receive. 2400 baud Hayes comp, V22 BIS. Inc modem cable & comms s/w!!

only £74.99
All Supra Modems come with a 5 year warranty!! Supra modems have not been tested by BT but they have been given between 80 and 90% ratings by the press.

US ROBOTICS PREFERRED DEALERS

Courier V32bis+FAX.....£386.99
Courier HST (16.8).....£403.99
Courier HST/Dual 16.8 Fax..£503.99
Sportster 14400 FAX.....£279.99
Sportster 2496+ FAX.....£152.99
WorldPort 14.4+FAX.....£289.99

If you thought V32bis was fast try the HST! All come with a 5 year warranty and are FULLY BABT Approved!

PACE MODEMS

MicroLin V22b FAX.....£216.99
MicroLin V32b FAX.....£449.99
5 year warranty and FULLY BABT Approved!!

PRIMA A500 & A600 RAM

3 YEAR WARRANTY!!

A500P A600
 Unpopulated.....only £16.99...£23.99
 Populated to 512K...only £19.99...£28.99
 Populated to 1 Mb...only £28.99...£33.99
 2 Mb A600 OR A1200 RAM card.....£99.99
 4 Mb A600 OR A1200 RAM card.£169.99
AMIGA A500 512K RAM by PRIMA
 for the original 1.2/1.3 AMIGA..only £13.99

32 BIT RAM (for A4000 etc)

1 Mb SIMM.....£POA
 2 Mb SIMM.....£POA
 4 Mb SIMM.....£POA
 8 Mb SIMM (only for Microbotics).....£POA

RAM & CUSTOM CHIPS

Co processors for the A4000
 Motorola 68882 PLCC(25Mhz)..£69.99
 Motorola 68882 PLCC (33Mhz)..£79.99
Co processors for Microbotics
 Motorola 68882 PGA (33Mhz)..£79.99
 Motorola 68882 PGA (40Mhz)..£89.99
 Motorola 68882 PGA (50Mhz)..£157.99
 (for Microbotics boards inc crystal chip)
 1 mb by 8/9 SIMMS.....per 1 Mb £POA
 4 Mb by 9 SIMMS.....per 4 Mb £POA
 1 Mb by 4 DRAMS.....per 1 Mb £42.99
 1 Mb by 4 ZIPS.....per 1 Mb £39.99
 256 by 4 DRAM (DILs)
 4+ (512K).....now only £3.99
 8+ (1Mb).....now only £3.94
 16+ (2Mb).....now only £3.89
 Kickstart 1.3.....£17.99
 Kickstart 2.04.....£24.99
 Fatter Agnes 8372A.....£25.99
 Super Denise.....£16.99
 6571-0326 Keyboard controller...£13.99
 CIA 8520A I/O controller.....£7.99

MICROBOTICS RAM

The MBX1200Z CO-PROCESSOR & RAM BOARD for the A1200

Realise the full potential of your A1200 with this trapdoor expansion. inc real time clock
 68881 14MHZ.....£119.99
 68881 25MHZ.....£129.99
 68882 33MHZ.....£139.99
 68882 50MHZ.....£209.99
 The RAM boards can only work with the use of the Co-Pro board

SUPRA RAM

Simply the best! Fits onto the side expansion port
 Auto configures with no software patching.
 8Mb pop to 2 Mb.....£159.99
 8Mb pop to 4 Mb.....£214.99
 8Mb pop to 8 Mb.....£319.99
 8Mb pop to 2 Mb for 2000/1500 range..£149.99

GVP GVP HARD DRIVES

AMIGA A500 HARD DRIVES from only £247.99

A500 GVP Combo's

A530 Combo 40MHz from only £475.99

68882 Co-Processor Kit for A530.....only £214.99
 32 bit 60ns 1Mb SIMM for Accelerator.....only £64.99
 32 bit 60ns 4Mb SIMM for Accelerator.....only £179.99

1500/2000 Hard Drives

Impact Series II HC8+ from only £289.99
 All GVP products come with a full 2 year warranty

ROCHARD DRIVES

ROCTEC A500 CONTROLLER CARD

Very similar in style to the GVP HD8+ but without a hard drive so you can fit your own. Expands to 8Mb of RAM using SIMMS.....£149.99

ROCTEC 42Mb.....£219.99

ROCTEC 80Mb.....£299.99

ROCTEC 120Mb.....£315.99

ROCTEC ROCMATE.....£99.99

SPECIAL OFFERS!

DATALUX CLEAR MOUSE

High quality clear 2 button mouse
 only £19.99

PAGESTREAM 2.2 DTP

only £64.99

XCOPY PRO PLUS HARDWARE....£25.99

TECHNOSOUND TURBO

only £25.99

ROCHARD DRIVES for the A500/A500+ from £219.99

POWER SCANNER V3

With the latest version 3 software for bright & sharp grey scale performance. Flexible scanned image display manipulation options, plus Clean up, embolden, resize & flip.

only £114.99 on demo

Colour version only £239.99

EPSON GS6500 COLOUR FLATBED

only £689.99 phone for details & demo

Art Department Pro Scanner S/W..£109.99
 compatible with Epson ES300C, ES600C, ES800C, GT6000, GT6500 & GT8000

MICE & TRACKERBALLS

GOLDEN IMAGE MEGA MOUSE

90% rating. Our best selling mouse.....£12.99

DATALUX CLEAR MOUSE

High quality clear 2 button mouse.....£19.99

Zydec Trackball.....£29.99

Golden Image Trackball....£37.99

DISK DRIVES

Prima 3.5" only £56.99

1 meg high quality external drive at a great low price.

Roclite 3.5" only £62.99

super slim Roclite. Best review for disk drives in Amiga Format. Now with built in virus checker and anti click device!

Cumana 3.5" only £56.99

1 meg external drive. The best name in disc drives now at a great price.

OPAL VISION

24 bit graphics card & video system for the 1500 2000/3000/4000. Includes software bundle

only £619.99 with Imagine 2!

GENLOCKS

Commodore A2300 internal Genlock only £119.99

GVP Genlock.....only £297.99
 features professional SVHS output

Rocgen Plus.....only £149.99

Includes dual control for overlay and keyhole effects, extra RGB pass thru. Now A1200 compatible!

Rendale 8802 FMC..only £169.99

ROCGEN ROCKEY

For creating special effects in video production with genlocks.....only £139.99

PRIMA ROM SHARERS

This high quality ROM sharer features a flexible ribbon connection so that it can be positioned anywhere within your A500 Plus or A600. Full 2 year replacement warranty

now only £19.99 or £27.99

for keyboard switchable version

EMULATORS

COMMODORE 386 25SX..£169.99

This is a PC 386-25SX Bridgeboard running at 25 MHz

NEW! COMMODORE

486 SLC SX25 PHONE FOR DETAILS

ONLY £289.99

ROMBO PRODUCTS

New! VIDI 12 Real Time.£134.99

Real time colour digitizing from any video source. full AGA support

New! VIDI 24 Real Time.£223.99

24 bit quality real time colour digitizing from any video source. Full AGA support

New! VIDI 12 AGA.....£74.99

Full support for AGA chipset. Colour images captured in less than a second, mono images in real time with any video source. Multitasking s/w, cut & paste.

VIDI 12 SOUND & VISION AGA

with built in Megamix Master.....£98.99

TAKE 2.....£37.99

Features include load and save from D. Paint animations and IFF files. Supports HAM graphics.

Megamix Master.....£29.99

8 bit, high spec. sampler. Special effects include echo that can be added in real time, fully multitasking & easy to use.

ACCELERATORS

MICROBOTICS

New M1230 for A1200 with up to 128 Mb fast RAM!

M1230 XA 33Mhz, 0Mb.....£245.99

M1230 XA 40Mhz, 0Mb.....£264.99

M1230 XA 50Mhz, 0Mb.....£329.99

See "RAM & CUSTOM CHIPS"

section for prices on Co-pro's and 32 bit RAM. Call for prices on upgrades from MBX1200Z to MBX1230XA

GVP

A1230/0Mb RAM for A1200 only £284.99

A1230/1Mb RAM for A1200 only £384.99

1500/2000 G-FORCE 030-25MHz with 4Mb

32 bit RAM.....only £479.99

G-Force 030-40MHz with 4Mb 32 bit RAM

only £729.99

NEW! SUPRA ACCELERATOR

for the A500/A500+

& A1500/2000

28 Mhz, uses A500 side port so there is no internal fitting

only £129.99!

ACCESSORIES

Real Time A1200 internal clock module.....only £14.99

Mouse/joystick manual port switcher.....only £13.99

Computer Video Scart Switch.....only £19.99

2/3/4 way Parallel port sharers £POA

Amiga Sound Enhancer Plus by Omega Projects. Hear the Amiga's sound like you've never heard it before! ..only £36.99

QUALITY MOUSE MATS.....£3.99

20 CAPACITY DISK BOX.....£2.99

40 CAP LOCKABLE DISK BOX.....£4.99

100 CAP LOCKABLE DISK BOX.....£6.99

*90 CAP STACKABLE BANX BOX.....£9.99

*150 CAP STACKABLE POSSO BOX.....£18.99

*add £3.00 delivery if purchasing just one Posso or Banx box. Free delivery when purchased with other product or when buying 2 or more.

AMIGA A500 DUST COVER.....£3.99

AMIGA 600 COVER.....£2.99

14" MONITOR DUSTCOVER.....£6.99

12" MONITOR DUSTCOVER.....£5.99

AMIGA TO SCART CABLES.....£9.99

STD 1.8 METRE AMIGA PRINTER LEAD.....£4.99

MODEM AND NULL MODEM CABLES.....£9.99

AMIGA CONTROL STATIONS

A500 or 1200 VERSION.....£36.99

A600 VERSION.....£29.99

PRINTER STATION.....£28.99

DISKS

All disks are 100% error free guaranteed

New High density 3.5 inch bulk and Fuji branded

Please phone for best prices!

QTY 3.5" DD/D5 Bulk OR FUJI DD/D5 BRANDED

10.....£4.99.....£6.99

30.....£14.99.....£17.99

50.....£21.99.....£28.99

100.....£39.99.....£54.99

200.....£73.99.....£99.99

500.....£169.99.....£POA

1000.....£339.99.....£POA

Branded disks come complete with labels

Disk Labels.....500...now only £6.99

Disk Labels..1000...now only £9.99

SOFTWARE

PD IN STOCK

BUSINESS

Gold Disk Office U.K.spec.....£45.99

Home Accounts 2.....£37.99

MaxiPlan 4.....£36.99

Mini Office.....£38.99

PERSONAL FINANCE MANAGER +.....£29.99

PLATINUM WORKS.....only £29.99!!

Excellent integrated business/office pack, with powerful 123 comp/spreadsheet, word processor & database

MISCELLANEOUS

A Talk comms Software.....£9.99

Distant Suns new version!.....£49.99

GB Route Plus.....£45.99

GP FAX Software.....£44.99

X-CAD 3000.....£284.99

MUSIC/SOUND

Audio Engineer.....£73.99

Audio Engineer Plus V2.....£243.99

Bars & Pipes Professional.....£259.99

Clarity 16 sampler.....£105.99

Deluxe Music Construction Set.....£49.99

Pro Midi Interface by Microdeal.....£24.99

Stereo Master.....£29.99

SUPER JAM.....£94.99

Techno Sound Turbo.....£25.99

Techno Sound Turbo 2 NEW!.....£34.99

PROGRAMMING

Amos Creator.....£34.99

Amos Compiler.....£21.99

Amos 3D.....£25.99

Amos Professional.....£47.99

Amos Professional Compiler now only £24.99

DEVPAC3.....£50.99

Easy AMOS.....£24.99

LATTICE C Language Version.....£229.99

UTILITIES

AMIBACK.....£44.99

AMIBACK TOOLS.....£44.99

AMIBACK PLUS TOOLS BUNDLE NEW!.....£74.99

AMIGA RELEASE 2.04 UPGRADE KIT

Complete with: Kickstart 2.04 CHIP, Workbench 2.04, Install, Fonts & Extras disks full manual set...only £77.99

AMIGA Release 2.1 software upgrade.....£49.99

Cross Dos V5.....£36.99

Directory Opus 4.....£49.99

Giga Mem.....£49.99

Hypercache Pro.....£36.99

QUARTERBACK V5.....now only £40.99

Prima A600/1200 Hard Drive setup software. This is the best setup software on the market!.....£5.99

Latest version of this Fast & Famous hard disk backup utility.

Quarterback Tools.....now only £45.99

Quarterback Tools Deluxe.....now only £69.99

Xcopy Pro inc. hardware.....now only £25.99

VIDEO AND GRAPHICS

37 Compugraphic fonts Vol 1, 2, or 3 by GT..only £9.99

Adorage (creates special video effects).....£61.99

Art Department Pro 3.....only £145.99

Art Department Scanner software.....only £114.99

ART EXPRESSIONS.....By Soft Logic £145.99

BRILLIANCE NEW! Pro. paint and Animation.....£149.99

CALIGARI 24 NEW! 3D Design and animation.....£239.99

Deluxe Paint 3.....£12.99

Deluxe Paint 4 AGA.....£66.99

EXPERT DRAW.....only £49.99

EXPERT 4D JR.....only £37.99

Flexidump printer utility.....£31.99

Imagine V2.....£119.99

Make Path for Vista.....£26.99

Morph Plus.....£147.99

Personal Paint NEW!.....£45.99

Real 3D Classic.....£77.99

Real 3D V2.....£365.99

Scala 1.3.....£72.99

Scenary Animator V4 (3Mb required).....£62.99

TRUE PRINT/24.....£49.99

VIDEO DIRECTOR.....£115.99

VIDEO MASTER.....£49.99

IT'S HERE

The Video Toaster is the best piece of Amiga kit in the world, used by TV and film companies to generate amazing effects and graphics. Now for the first time it can be used in the UK, Nick Veitch wants to show you how wild it is...

FROM THE DAWN of Logie Baird, television has proved itself to be a versatile medium, an information channel which has turned its bandwidths to everything from entertainment to advertising, from home shopping to selling religion, from the local news to global media events, from Tiananmen Square to the Gulf. There is no comparison. Television has the power to change the world.

OK, that's all very well, but what's all this techno cyberboggle got to do with us? Well, there is a device in production in California that has the power to change the shape of television forever. This device is actually a peripheral for a humble home computer. The computer, of course, is an Amiga. The device? New Tek's Video Toaster.

TIME FOR TOAST

The Toaster is the most price-effective and powerful single unit video production facility. It gives the Amiga the power to render superb animations, create video quality text and manipulate graphics mixed with live video in any number of devilish ways. In America it has been nothing short of revolutionary.

The Toaster was the stuff of a Silicon Valley legend. A team of designers locked away for four years, eating cinnamon cakes and rarely seeing daylight, toiled away in secret creating the dream machine. Their front was that they were working on a new toaster, and so they were.

The Toaster is not a single entity. It comprises a piggy-backed video slot card and 45 disks containing the hottest rendering and video manipulation software in existence.

But all this happened a long time ago. Why should we now bother going back over old ground? Well, early in its life a great tragedy struck the Toaster. One of the important components, the image generator chip supplied by Sony, fell out of favour at the Japanese HQ. It wasn't taken out of circulation - in fact it is still in production now, but any further development was put on freeze. This was only a tragedy for us Europeans though, because Sony never produced a PAL version of the chip.

To redesign the Toaster with another chip at its core would have been an expensive and lengthy task, and one which NewTek didn't really need to undertake. The Toaster had already caused a storm, especially after it won a Best Mac Peripheral Award. That's right, cunningly disguised Amigas, fitted with Toasters, were successfully displayed and sold as external video devices for the Apple Macintosh at Mac shows all across North America.

With the mass of publicity, Toasters leapt off the shelves. With it being all they could do to keep up with demand in their home territory, it was hardly surprising that NewTek didn't feel the need to expand into overseas markets too.

DIGITAL VIDEO EFFECTS

The Toaster can create literally hundreds of digital effects such as those seen all the time on TV. Flips, spins, tiles, curtains, page-peels, zooms, squeezes, blinds, rolls and mosaics are but a brief selection from the list. Many of the effects such as whips, zoom trails and luminance dissolves were impossible on conventional equipment when the Toaster appeared on the scene.

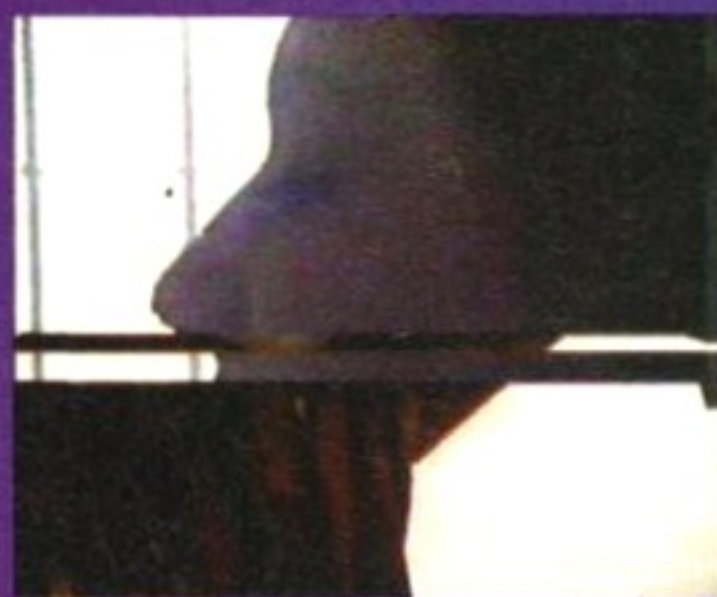

The Toaster is capable of so many effects, you won't have heard of half of them!

FRAME GRABBER

The Toaster also features a built-in frame-grabber and frame store. This will save a full resolution video image in 16.8 million colours for use in other parts of the Toaster or for direct playback through the frame store. The playback speed is up to 5fps when stored in the Amiga's RAM, and obviously they can be used in conjunction with the Switcher for transitions and effects.

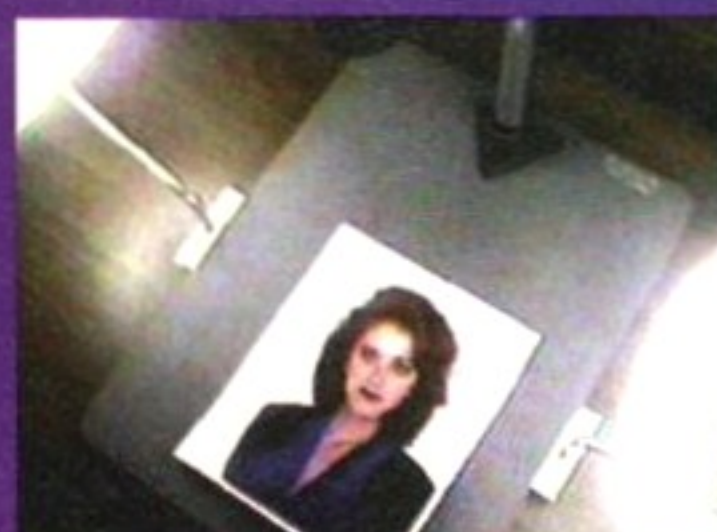

Individual frames can be grabbed and stored - colour comes in 16.8m varieties!

CHARACTER GENERATOR

When you need a title or video caption, there is no reason to quit the Toaster. Amongst its armoury there is an excellent character generator, which is nothing to do with RPGs but is a lot to do with rendering fonts at video resolution.

The Toaster comes with its own collection of fonts, including some multicoloured and chrome-effect examples.

Along with pure text on screen you can play around with 24-bit graduated tints, semi-transparent shadows and variable speed scrolling. The captions can be linked to the switcher to provide any number of spinningly, zoomingly, tumblingly amazing displays.



There are many different fonts and treatments you can use to create video titles.

COLOUR PROCESSOR

A powerful colour processing engine is provided, capable of manipulating and digitally altering any image that comes before it. Many of the effects will be familiar to those who use *Art Department*, but many more are unique to the Toaster software. Image Processing on the Toaster can handle just about any effect you could possibly think of.



Images can be uniquely manipulated and digitised beyond recognition.



NO, WITH MARMALADE...

But now that has all changed. The Toaster, now in its vastly improved Toaster 4000 form, will shortly be making its official debut in this country.

Toasters have been used in this country for years, but only for off-line processing and to run *Lightwave*, the superb rendering software. The difference now is that NewTek have been talking to Prime Image, a company which specialises in video hardware and produces a 'standards converter'. This gadget will convert NTSC signals into a European PAL signal. So, apart from having to install a few more boxes in your Amiga, you can have your video workstation toasting away in a decent screen mode.

So what can the Toaster actually do for you? Well, just take a look at the images on this page. Everything here was generated by the Toaster, working on recorded video sources (it could just as easily have been from live sources). In fact it is far easier to talk about what the Toaster can't do for you. Anyway, keep reading for a guided tour to the miracle that is the Toaster...

Continued overleaf →

TOASTERPAINT

The ultimate video workstation wouldn't be complete without a 24-bit paint package. The *ToasterPaint* application can be used to generate your own artwork in 16.8 million colours or to manipulate images produced in *Lightwave* or grabbed using the frame-grabber. This is more than just a simple painting tool though, advanced operations such as rotation, texture mapping, anti-aliasing, blurring and re-sizing are all available to the user.



The Toaster's 24-bit paint package, *ToasterPaint*, is more than just a tool.

LIGHTWAVE 3D

Lightwave is probably the most highly regarded ray-tracing software for the Amiga. Some people have been known to buy Toasters just so they could use it! The only other Amiga package that could possibly compare to it is *Real3D2*.

Lightwave renders computer designed images into full 24-bit resolution. Aside from its advanced mapping abilities (which can cope with reflection, textures, specularities, diffusion, bumps and transparency, *Lightwave* can also handle fog effects, motion blur and dynamic particle systems.

Lightwave can be used to build up extensive animations quickly and easily with its advanced key framing and tweening options, so you are not limited to just one image or committed to the tedious task of creating each frame by hand before rendering.



Ray-tracing with the excellent *Lightwave* software is the ultimate experience.

GENLOCK

Another vital piece of equipment which has been crammed into the Toaster is a genlock. The Toaster can use this to overlay Amiga generated graphics (such as captions or logos) on to an incoming video source or over either of the two frame buffers. As with all of the components that make up the Toaster, this genlock conforms to the most stringent of requirements for full broadcast video.

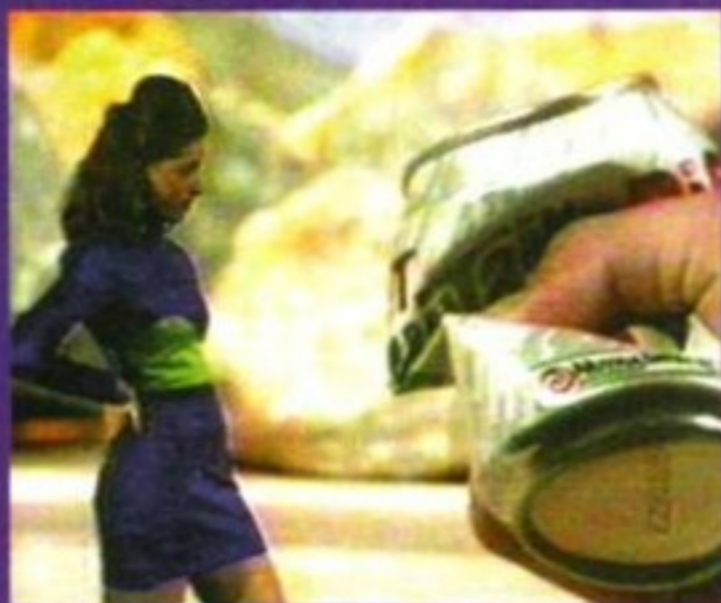

The Toaster's built-in genlock can overlay Amiga graphics on to a video source.

THE SWITCHER

The backbone of all of the Toaster's myriad parts is the switcher control program. This is the software which allows the user to combine the various effects with up to seven inputs (including four 'live' video inputs) and produce both a programme and a preview output. This is where the user can get creative with all those cuts, fades mixes and wipes.

The Switcher also controls the linear keyer and can accept an external GPI trigger.



The switcher control program is used to pull all the effects together.

LIGHTWAVE

This stunning shot from the award-winning sci-fi series *Babylon 5* was created entirely in *Lightwave*.

THE MOST INTERESTING part of the entire \$2,000 Toaster package for most people is the amazing *Lightwave* rendering software. To compare *Lightwave* to the likes of *Imagine* is like comparing an A4000/040 to a ZX80 – they are light years apart.

Lightwave was the first rendering package to break away from the traditional tri-view mode employed by other modelling packages. The tri-view is a throw-back to the place where 3D-rendering packages originated – the Computer

Aided Design workshops. Since draughtsmen were used to creating objects viewed from three planes (front elevation, side elevation and plan views) it seemed only natural for their early computer counterparts to adopt the same system. This is all very well for designers, but the problem for modellers is that it is very difficult to visualise what the image would be like when viewed from any other angle, which after all is the whole point.

Lightwave does offer the traditional views (albeit one at a time) but does not restrict you to

these. A full moving view with true perspective is also available, enabling the user to position the shot with a wire-frame model while the objects are still being designed. This is a feature which has only just become available in other software.

THE MODEL SHOP

In order to create pictures, though, you first need objects to render. *Lightwave* separates the creation of individual objects from the composition of scenes and these are done in a Modeller module. The approach is very different from any other design system, but it is most like *Imagine* in that objects can be created and modified in layers. *Lightwave* has much more powerful tools, though.

Essentially the designer has at his disposal every tool a traditional sculptor has. You can manipulate objects by 'chiselling' them, drilling, bevelling or turning them on a lathe.

CHECK THE MAP

When it comes to surface-mapping your objects, *Lightwave* is only matched by *Real3D2*. Mapping is the process by which surfaces are given properties which affect the way they reflect light and therefore alter the way they look in the final image.

The types of surface properties found in almost every rendering package are reflectivity and specularity. These control the amount of light reflected by the surface and also the likelihood and intensity of any highlights appearing.

In addition to these, *Lightwave* has diffusion, luminosity, transparency, and bump maps. Bump maps control the actual texture of the surface. Without a bump map the surface of a sphere is treated like a sphere, but with one the sphere could become a textured object like an orange – the bumpmap adds information to the rendering process concerning the actual physical roughness of the surface, so light doesn't necessarily follow the obvious incidence-reflection path.

Another neat feature is the introduction of scaleable fractal noise which can be used to add a degree of realistic turbidity to any surface.



Mapping options as demonstrated on this 'bird' can completely alter the nature of objects.

This effect is also in evidence applied to a transparency map to create fog effects. That may not seem very clever to you, but think of the poor Japanese mathematician who spent over six years of his life trying to create an algorithm that could render a realistic fog effect!

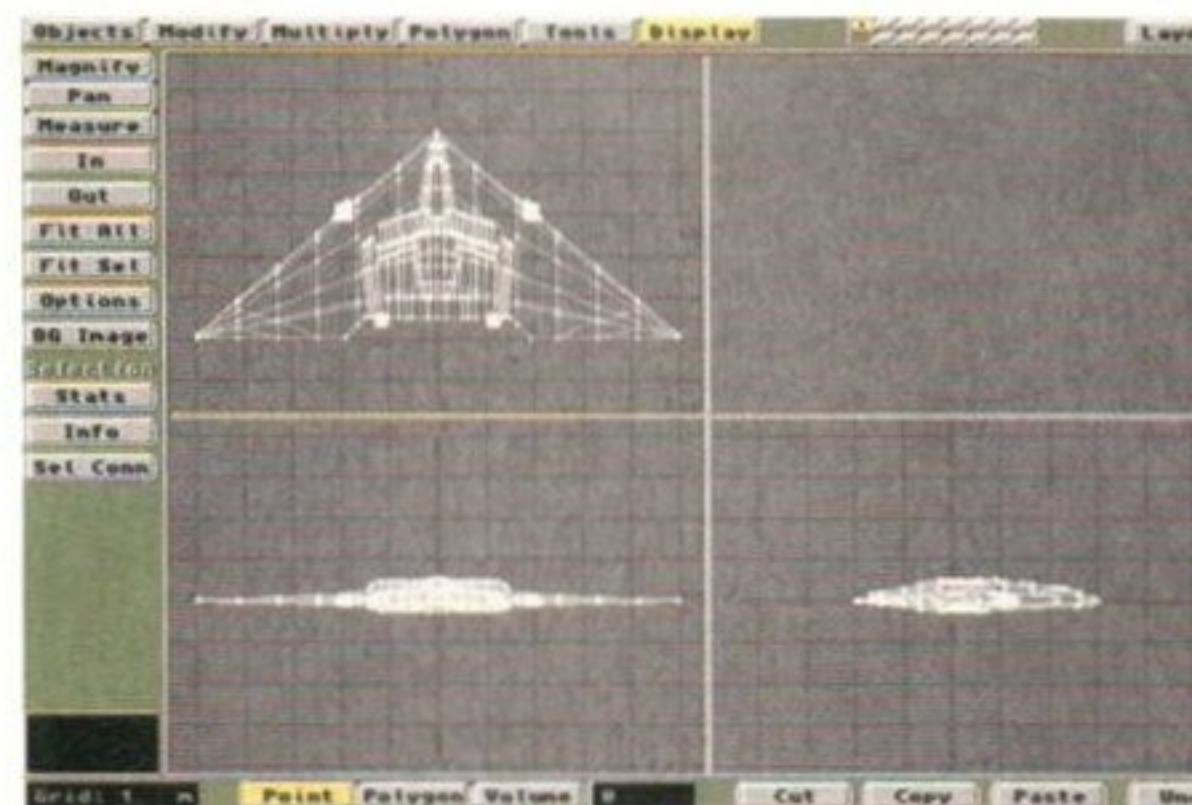

The Modeller screen from *Lightwave* shows the traditional tri-view approach, and a perspective window.

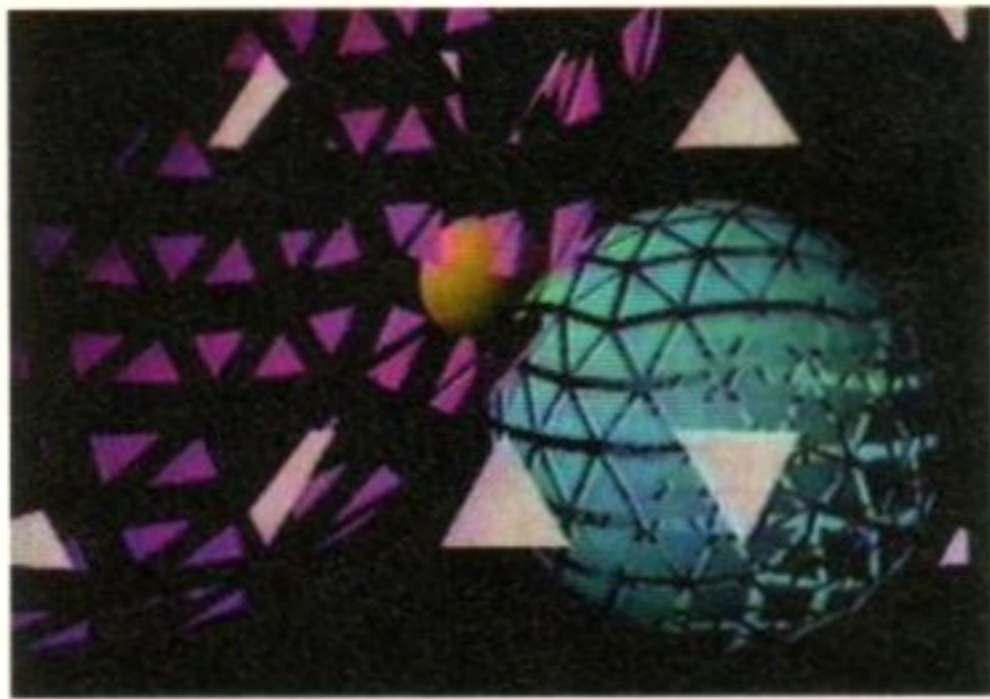

Even mathematical models like spheres can look impressive with a bit of inventive animation.



Animations can be created using only a small number of key frames and letting *Lightwave* fill the gaps.

Unlike in *Real3D*, the objects are created on a points and vertices matrix, but unlike *Sculpt* and *Imagine* this doesn't necessarily result in an obviously angular object.

Once the objects have been created you may then place them into your scene, a kind of virtual movie set. This is also where the light sources and camera are added to complete the environment.

Although the camera is the viewpoint from which the image will be rendered, it exists as a wireframe object just like anything else; that's because in the wireframe scene manipulating mode, you don't have to view the objects from the point where they will be rendered. This not only helps considerably when positioning the objects themselves, but can also be very useful when it comes to positioning the camera.

When the lights are ready and all the objects are in position, it is simply a matter of clicking on a button to render the image. It really is the equivalent of taking a 35mm picture, except that you don't have to queue for the results at Boots.

Many effects which would ordinarily be performed in some image processing package can be added before you take the shot – the equivalent of your fancy filters. These include a fog effect, a colour clipping tool and even an alpha-channel compositing feature, for combining the rendered image with an existing one (the equivalent of a multiple exposure).

ON THE MOVE

Of course, one picture is never enough. When you think about it, except for the rare static display genlocked over a newscaster's shoulder, most computer graphics are animated. Where would your News at Ten be with just a static intro sequence? Would people have stayed up to watch Newsnight during the Gulf War if it hadn't been for all those nice sequences of Tomahawk missiles skimming across the desert towards a final confrontation with a ventilation duct? No, pics have to move.

At this point the graphics engineer would be slightly anxious. The thought of moving the camera and/or the objects by minuscule amounts

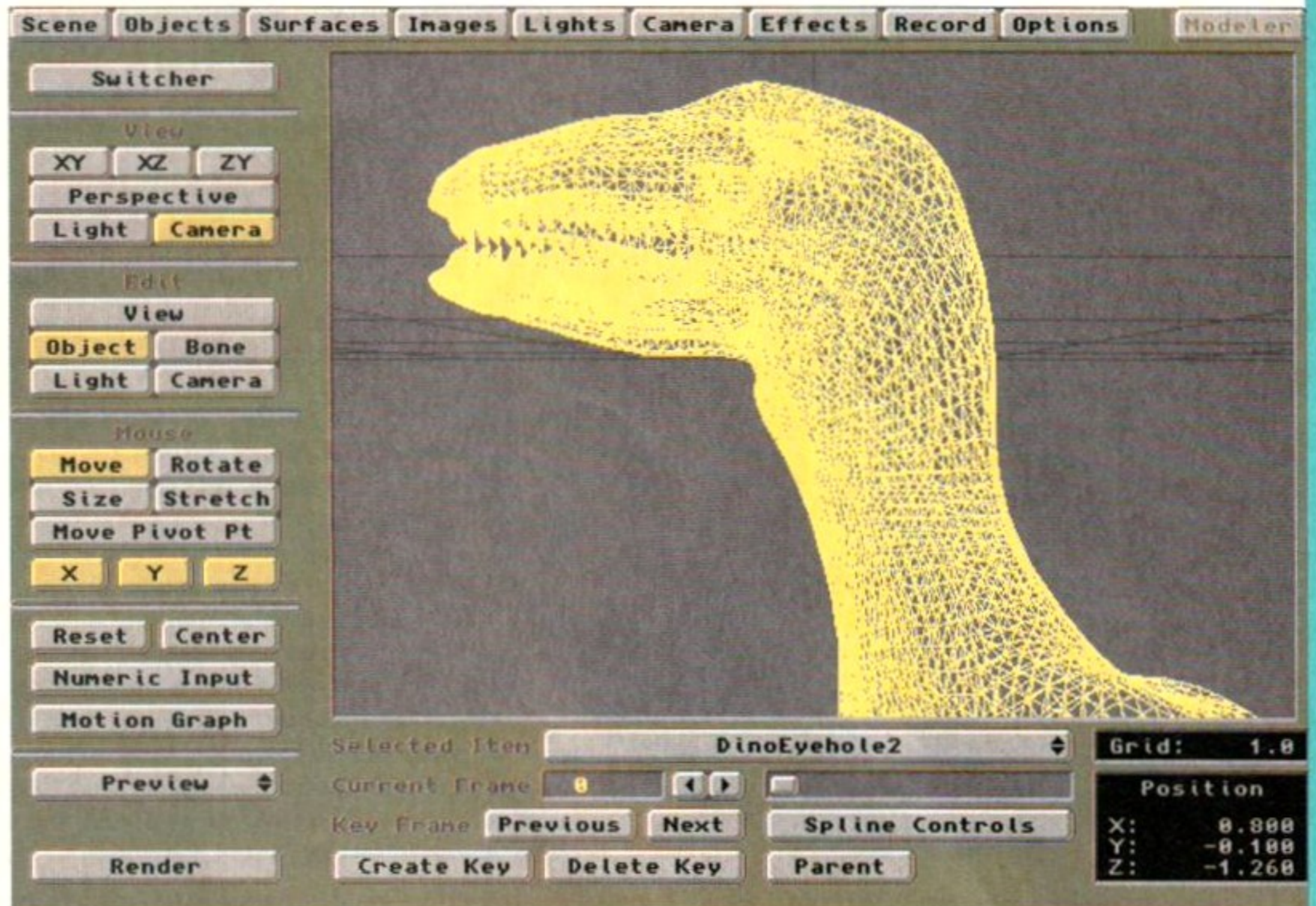

Is this how Spielberg managed all those dinosaur effects? No, he actually opted for equipment that is ten times as expensive, but his next project, *Sequest*, will use Toaster generated images.

and then rendering each frame individually is a bit daunting. Thankfully the programmers have thought of that.

There are about as many ways to specify motion and animation paths as there are rendering packages, but *Lightwave* uses one of the best, called key framing. Instead of having to specify the exact position of every object and the camera in each frame manually, you can simply specify two frames (the key frames) and the number of frames to be inserted between them. From the positional data in both of the key frames, *Lightwave* will add the positions for everything in frames in between.

Of course, you can still do things the long way, and in many cases this is more effective, but it doesn't half take a long time. Key framing is only particularly useful when composing straight fly-throughs or pans, but you can always use it to rough out an animation.

It is also possible to animate with spline animation paths. These produce smoother, curved

animation paths by treating the motion as a spline curve with tension and bias. These paths produce more realistic images, as they are closer to real-life phenomena such as inertia and gravity.

Apart from animation, splines are also used in envelopes. This is a way in which various attributes

of the scene, the camera or the objects. This is a useful way of creating effects such as changing lighting, camera zooms or even metamorphing objects. Because the envelope effects are independent of any motion path keyframing you may have done, both effects can be combined in one render sequence, completely automatically.



Using envelopes, the blob on this hill is morphed into different shapes in successive frames.

Lightwave is, on the surface, a very simple tool

to use and yet its depth is such that if you find yourself unable to create some particular object or effect, the chances are that you haven't read the extensive manual properly rather than it being impossible to do in *Lightwave*. A truly excellent, professional image generator.

Continued overleaf ➤

ON THE BOX

A great many TV graphics are being generated by computer these days, and not only in the places you would most likely expect to see them.

The graphics on ITV's *Chart Show* are obviously ray-traced images, but how many people realise that in the opening sequence of the BBC's *9 O'Clock News* around 80% of the set doesn't exist in the real universe?

Unfortunately the BBC didn't use the Video Toaster to create that graphic, but considering that they paid in excess of £3 million for it, perhaps they should have.

Of course the benefit of using *Lightwave* and the Toaster is that once the images are rendered they are already on-line in your video system ready for overlay at the touch of a button.

It is not surprising then that *Lightwave*-generated graphics are replacing those produced on more expensive systems in the USA. With a PAL transcoded Toaster to be officially launched at the beginning of October, it may not be too long before *Lightwave* (and the Amiga) are taking the credits in more British television. In fact, they may even be generating the credits.

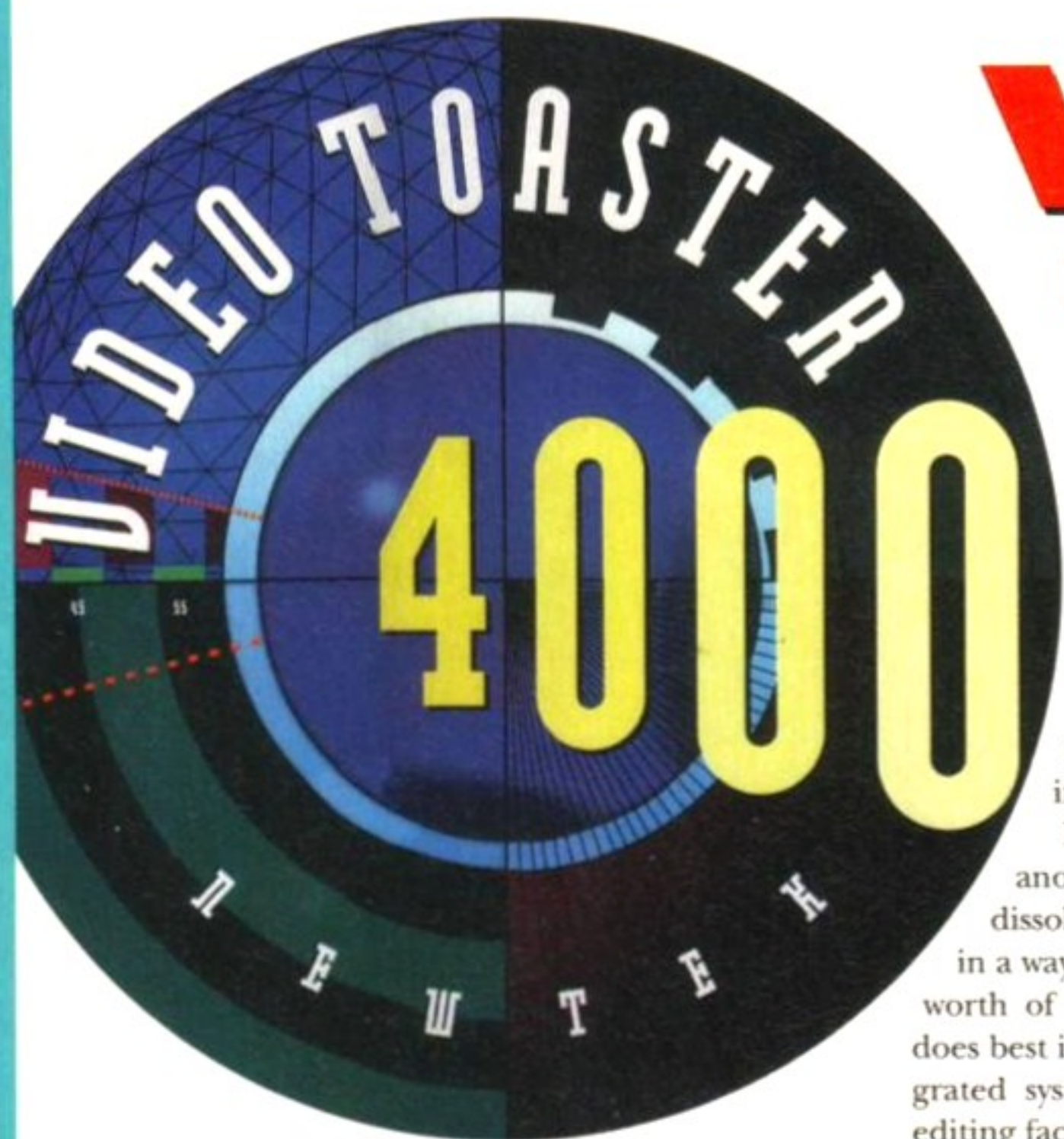

VIDEO TOASTER

DIGITAL VIDEO EFFECTS

THE VIDEO TOASTER is the most exciting video device created, on any platform let alone on the Amiga. It is a video production system on a card, and so this naturally enough includes digital video effects, or DVEs.

DVEs are transitions from one scene to another, which can be as simple as a cut or dissolve, to flying one frame out and another in a way previously impossible without £100,000 worth of vision mixer. What the Video Toaster does best is provide these effects as part of an integrated system with access to other useful video editing facilities all on-line at the same time.

As we've seen, the Toaster is divided into what it calls 'Slices', a pun on the toast theme, and the primary Slice is the Switcher.

THE VT SWITCHER

The heart of the Video Toaster is the Switcher, what we in the UK call a vision mixer. The Switcher is the screen you control almost all the Video Toaster functions from, and it allows you access to *Lightwave 3D*, the *Caption Generator*, and *ToasterPaint*. Over the face of the Switcher are buttons, called 'Croutons', which operate the effects.

Like vision mixers the world over, the Switcher allows you to make transitions in a variety of styles.



A fairly simple pixelated dissolve is only a brief sample of what the Toaster can do.



The effects can be applied with mask and genlock effects to incorporate Amiga graphics.



Or you can use the frame buffer to store and process two video images at once.



Of course the Toaster can control the precise placement of the second image.



Instead of making edits seamless, you can make them more dramatic with the right effect.



Venetian blind effects are a bit passé these days, but you might want to be years out of date...



Some quite spectacular effects can be produced with a little patience and judicious use of *Lightwave*.



The old scaling tile dissolve is a nice if slightly out of date effect.

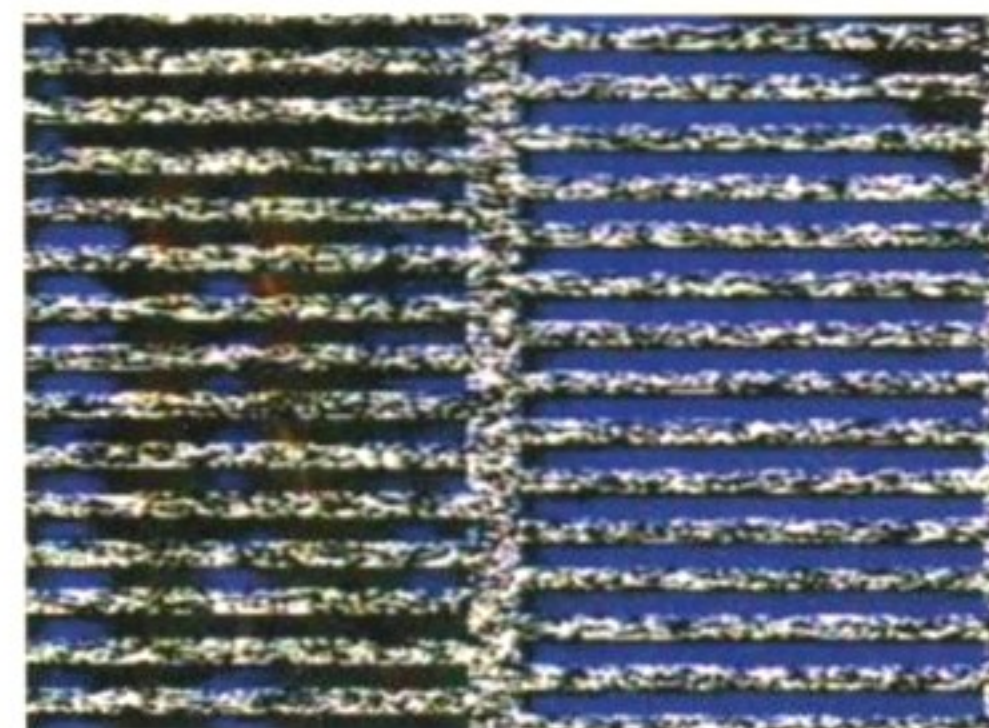

ToasterPaint can provide useful backdrops for many of the wipes.

some of which aren't available on any vision mixer for any price. You can perform tricks such as luma keying, plus it has access to another Video Toaster 'slice' called ChromaFX which allows you to add cosmic coloration on to your images. The ChromaFX engine basically allows you to alter the colour in your picture globally, over the whole frame, or in pre-specified bands across the image. The effects are a bit like colour cycling only with full broadcast quality video images.

The DVEs are divided into six banks of buttons on to which a tiny image is drawn which gives you an idea of what the button does. Push the button with the mouse and this activates the T bar. The T bar is a fixture on most vision mixers, and it's the manual control of the transition. This Toaster version is an imitation of the real T bar on a video mixing desk, only this theoretical T bar is mouse operated.

Move the image of the T bar with the mouse and the transition you have selected jumps into action. Push the mouse up and down and the speed of the transition is altered under your complete control. This is, of course, is not the best way to operate a transition, and try as you might you can't ever match the creamy smoothness of a

machine. Your hand will jiggle no matter how much you try to make it stop. Fortunately, you can also move the T bar more smoothly by using the auto feature. Set the speed of the transition and slap the space bar. The transition happens smoothly and automatically. Hit the space bar a second time and the effect reverses.

The Toaster has four inputs, and these can be selected from the main screen. You can cue up two source of video, and these can be two cameras, two VCRs, or one of each. Cue up one as the source and one as the destination, and then hit the transition. Voila! Instant TV. OK so it's not quite as simple as all that, because if you use two unsynchronised tape machines you get a wobbly result, but that's the basic gist.

TOASTER TRANSITIONS

The DVEs fall into certain readily defined categories. Flying frames are where a video frame zooms out of the screen in some way, either revealing another frame underneath or replacing the frame in a similarly aerial fashion. These are the classic DVEs and the one which most people who buy the Video Toaster in the US bought it for.

Next are the warp effects which distort the

ROLLING YOUR OWN

It's also now possible to create your own Toaster DVEs using a software program called *ToasterVision*. The program consists of five modules which enable you to not only create new transitions for the Toaster, but also to manage and alter the ones you already have. The program also has the facility to compress framestore images by up to 80 per cent, which as your average framestore image is upwards of 900K (bigger than a floppy disk!) can only be a blessing.

ToasterVision is available from Byrd's Eye Software, 9001 Northgate Blvd. #135, Austin, TX 78758 USA. Phone: 010 1 512 835-4811. The program is priced at \$224.95.

frame in some way, like squashing the frame up against the side of the screen to reveal another frame. Also 3D translations, where the frame is tumbled and twirled like a flat 3D plane. Allied to those effects are the ones in which a small square of the picture pops out of the frame and flies off, and this continues bit by bit until the whole picture has flown off the screen in various directions.

There are other effects which defy easy description. There are simpler ones like when the images of the new frame pile on to the screen from the left like a shuffled deck of cards. Another effect is the real time treatment which isn't actually a transition, but the Toaster uses the frame buffers to print images of previous frames behind the current image, so any movement is permanently stored on the current frame. This means trails are made by any moving object, and hands and arms in the frame which move leave behind cascading images of arms and hands as they go.

Not so obvious are the silhouettes and other digitised masking effects. These are digitised outlines of people and scenes which use the shape of the object for the transition. A figure walks across the screen pulling the new frame behind him for example, but there are more complicated and interesting effects in this line.

Pouring liquid, breaking glass, clouds shifting across the frame. These are totally organic effects and are the original effects which the Video Toaster brought to the world of video. The silhouettes include American football players, golfers, baseball players and new for the last revision of the software was NewTek's 'Everywhere Girl' Kiki Stockhammer in a variety of roles. For example one of the so-called 'KikiFX' has her walk on screen as if the shadow is cast on a bathroom window, she brushes her hair, then seems to notice us watching and pulls down a blind, on which of course is the next scene, with the blind forming the transition from one video source to the next.

The sports transitions have football players bumping into each other, pitchers pitching a small round image of the next frame, and golfers 'wiping' the screen with a swing of the club.

The Toaster System 2.0 also has some new 3D effects. The system doesn't allow you to create your own objects, but you can wrap video images around balls and cubes. Once wrapped on, these either spin off the screen or explode.

Throughout all this development, the Video Toaster software has been 'waking up' parts of the original hardware which were previously untapped. This evolution is complete with Version 3 of the software - a new version of the recent Toaster 4000 software which includes new versions of all the Toaster Slices including version 3 of *Lightwave 3D* and version 3 of the Switcher.

Continued overleaf



By creating your own masks you can customise the effects to your own needs.



Of course you can completely design your own fades by creating animated masks.



The old 'torn page' effect works particularly well when going from video to pure text.



You can use a programmable luminance keying effect for that extra unusual touch.



Alpha channels are very nice things, even though these circles are very good!



No, Alpha channels really are good, particularly if you can draw a decent rectangle to distort it.



The news wouldn't really be worth watching if there were no spinning title logos.

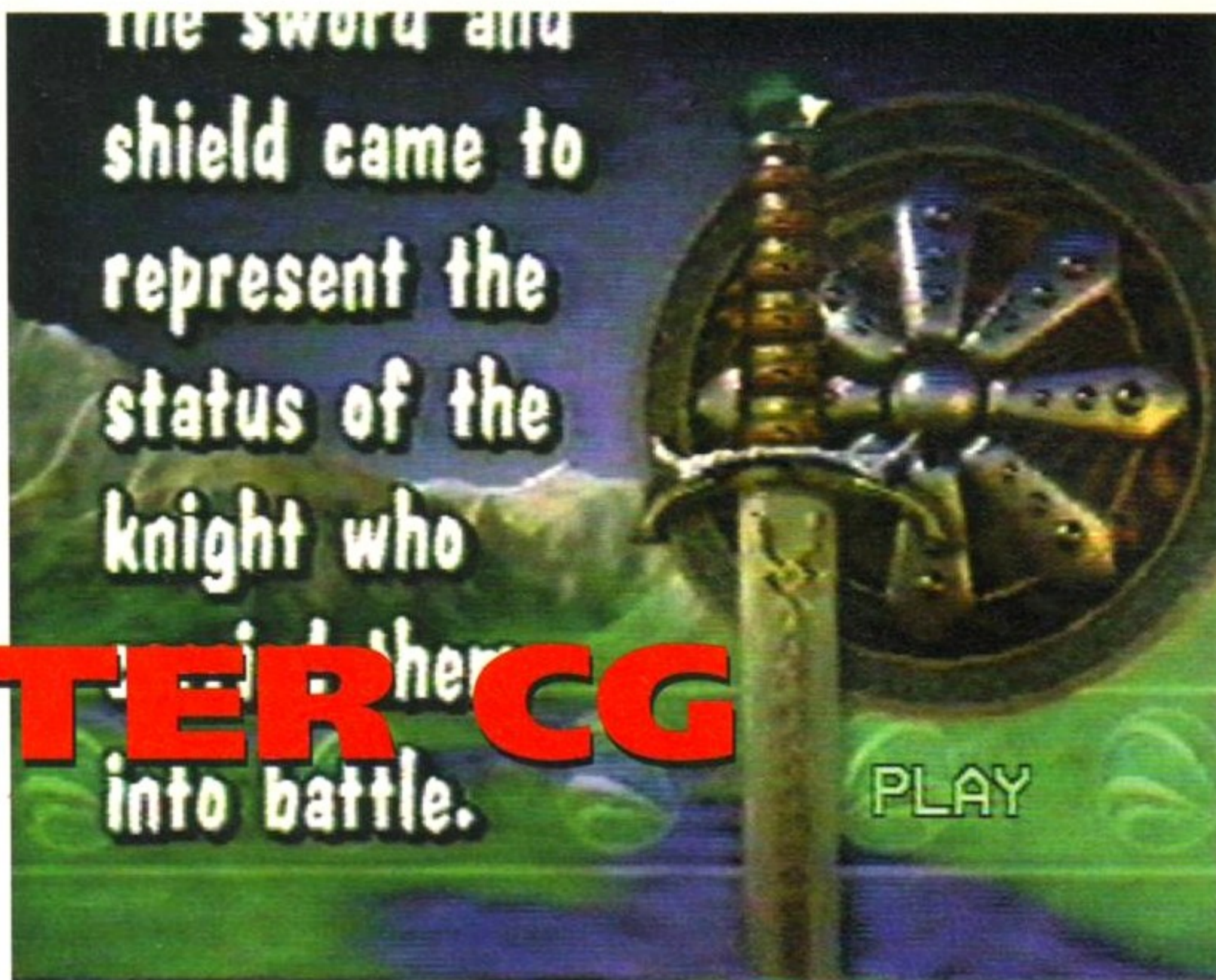

It is possible to overlay rendered images on to graphic backdrops generated in *ToasterPaint*. In this example, the text actually scrolls up the screen.

TOASTER CG

PERHAPS ONE OF the usually more mundane tasks that professional videomakers use their expensive equipment for is generating captions. Virtually every factual piece of footage has a caption in it somewhere, and even pure entertainment programs need a character generator for the odd title or credits sequence. The Toaster has a special 'slice' for this, called *ToasterCG*.

IN CHARACTER

Captions are all about text, so the Toaster has to be able to generate characters from stored fonts. It also needs to be able to generate them at any size required. 'Aha - sounds like a job for Mr Compugraphic,' I hear you say.

Indeed, the Toaster does support Amiga CG style fonts (which is not why the program is called *ToasterCG*, by the way - it stands for Character Generator), but it is more happy with standard Postscript fonts. Fonts must be individually loaded into the character generator one at a time, and in the specific sizes you wish to use them at. The reason for this is that all the fonts must be stored in RAM for use with *ToasterCG*. This may seem a bit of a pain, but it is sensible as it allows the software to manipulate the fonts at a reasonable speed.

The fonts are thus displayed in the requestor with their relevant sizes when you select them. You can then enter the characters on to the screen, but they only appear in a preview mode while they are placed in the correct position on the screen.

RENDERED SAFE

To actually lay down the text you need to select the Render option. The difference between the preview mode and the final rendered image is that while rendering *ToasterCG* will anti-alias the fonts directly on to the current screen so that you can see how they will look when displayed. Anti-alias-

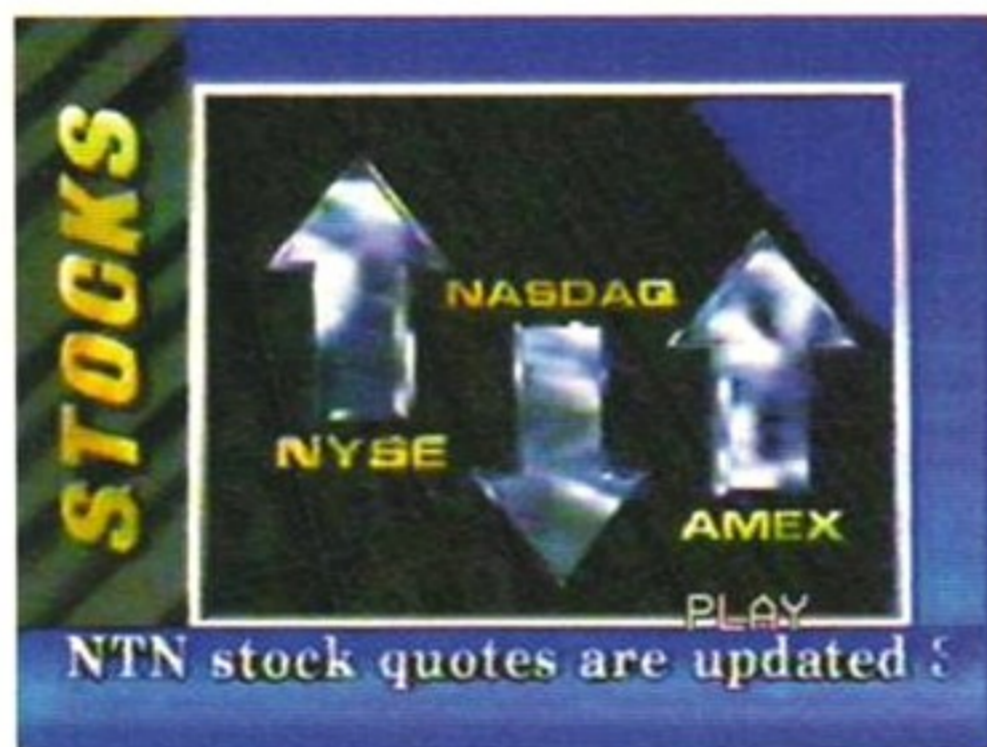

This screen is a compilation of several layers of Toaster-generated graphics.

ing is a technique used to ensure that the individual pixels of the font will not be too noticeable when displayed. This is a useful feature, which is important for italic fonts or characters which have diagonals in them as it reduces the 'staircasing' effect around the outline of the font.

Rendering also takes into account any text effects you may have specified. Not only can you add shadow effects to your characters (at varying angles) but you can also add transparency effects.

This gives the impression, when keyed over live video, of the text colourising the image below. The transparency characteristics for the text and the shadow can be entered separately so you can have solid text with a semi-transparent shadow, an effect which looks particularly impressive.

PAGE AFTER PAGE

Captions and screens for keying are created in 'pages' on the Toaster. If you like, these pages can be sequenced to form a book. The page way of working is the most sensible, even though successive pages may use the same backdrop with different words or vice versa.

There are four different types of page. The simplest is the Keyed page, which is text on a transparent background for overlaying. This is



Generated graphics can be overlaid over animated backdrops too, either live video or *Lightwave* anims.

probably the most useful and most used option, as the caption will be referring to some live video.

The second page type allows the graphic to be overlaid on to a backdrop, which may be either a solid colour, a graduated backdrop or any IFF image at all, really.

The last two page types deal with scrolling text - one for horizontal scrolls and one for verticals. There is no reason why you can't interleave these last two types, hum that catchy Tony Hatch ditty and take a trip back to when the airwaves were polluted by *Crossroads*.

ADDING SOME SPICE

Of course, once the 'pages' have been created, you'll want to overlay them on to something. For this it's back to the Switcher, where the caption pages can be manipulated in the same way as any other computer generated graphic. That means that with full image keying you can have your captions appear using any of the wipes or DVEs explained earlier.

It is now de rigeur to have page-peeling captions on American TV, and the Toaster can do that easily. By using the frame buffer you can even mix between two generated caption pages.

Continued overleaf

TOASTER FONTS

In addition to the fonts which are supplied with the Toaster (and that is quite a few), there are now several font libraries operating in America which offer complete families of popular fonts in a Toaster useable format. In fact there are probably more fonts available for the Toaster than there are for a standard Amiga.

One company, B&P Graphics, is offering an incredible 1,000 Adobe Type 1 typefaces on CD-ROM for a mere \$499!



the latest AMIGA

technology from

Gordon Harwood Computers



NEW! AMIGA A1200 DESKTOP DYNAMITE PACK

INCLUDES... AMIGA A1200 COMPUTER WITH A FANTASTIC NEW SOFTWARE BUNDLE... DELUXE PAINT IV-AGA, PRINT MANAGER, THE SUPERB NEW 'DENNIS-AGA' (based on the film), 'OSCAR-AGA' & the home word processor 'WORDWORTH 2-AGA' (compressed version).

Only...£155 Phone us NOW for KEENESEST PRICES!

DESKTOP DYNAMITE is available as an alternative in Harwoods Autumn Gold Packs (shown right) including HD versions, PHONE!!!

AMiGA 1200 EXCLUSIVE PACK Options

1200's with/without Hard Drives+Printers+Monitor/TV's!!! At Harwoods YOU decide the configuration of your NEW AMIGA 1200! Do you need a Hard Drive (and if so will it be an 80, 120 or 210Mb. capacity? Would you prefer serious software or a terrific games pack. Will you need a monitor or printer? Would you like the peace of mind of a LIFETIME WARRANTY? ALL THE OPTIONS ARE THERE FOR YOU TO CHOOSE!!!

AMiGA PACK1

The ideal first time package for everyone... AMIGA A1200 COMPUTER WITH NIGEL MANSELL'S GRAND PRIX & TROLLS **£264.95**

AMiGA PACK2

As Pack 1 above plus... THE SUPERB PHILIPS PRO 2000 MONITOR/TV, 14" COLOUR MEGASOUND!!! **£499.95**

AMiGA PACK3

As Pack 1 above plus... A PHILIPS PRO 2000 14" COLOUR MONITOR/TV & A CITIZEN 240C COLOUR PRINTER IN ONE GREAT BUNDLE! **£759.95**

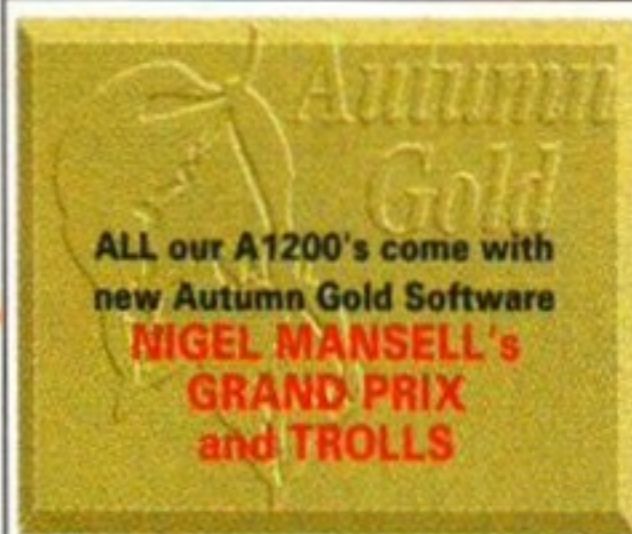

AMiGA POWERPRO PACKAGES!

COLOUR POWERPRO PACK

A1200 COMPUTER FITTED WITH 80Mb. HARD DRIVE supplied with... CITIZEN 240C COLOUR PRINTER (inc. all leads & Citizen Print Manager 2), PHILIPS PRO 2000 COLOUR TV/ MONITOR inc. leads, A1200 Dust Cover, 240C Dust Cover, Mouse Mat, Printer Paper/Labels, Final Copy II, Superbase, Superplan & Autumn Gold Software - What a Pack! **PACK P/80**

A COMPLETE PACK FOR EVERYONE **only £999.95**

COLOUR POWERPRO PLUS PACK

The COMPLETE POWERPRO pack as detailed above but with the superb MICROVITEC 14" COLOUR MULTISYNC MONITOR (in place of a Philips Pro 2000) FOR THE REAL ENTHUSIAST **£1199.95**

A1200 Options 'AT A GLANCE'

AMIGA PACK DETAILS	NO HARD DRIVE	HARD DRIVE Options (see pg 2)		
		80Mb.	120Mb.	210Mb.
A1200 AUTUMN GOLD STAND ALONE PACK	£264.95	£464.95	£534.95	£649.95
A1200 AUTUMN GOLD + PHILIPS PRO 2000 MONITOR/TV	£499.95	£679.95	£754.95	£879.95
A1200 AUTUMN GOLD, PHILIPS PRO 2000 MONITOR/TV & CITIZEN 240C COLOUR PRINTER	£759.95	£939.95	£1014.95	£1139.95
A1200 COLOUR POWERPRO PACK (see feature)	NO OPTION	£999.95	£1074.95	£1189.95

ADD JUST £200 IF YOU PREFER A MICROVITEC 14" COLOUR MULTISYNC MONITOR IN PLACE OF A PHILIPS PRO 2000 (Applicable to packs above that include a Monitor/TV)

The new fully expandable Amiga 32 Bit CD is the machine for the ardent games player who may also want a full computer system as their needs grow. The best of 256,000 colour Amiga AGA graphics technology, PLUS a multi-session CD drive, to give potentially 600Mb. of ultimate animated graphics & digital stereo sound on each optical disk. MANY titles are under development, scheduled for release before Christmas at prices far lower than those for other CD systems!!! What's more, at Harwoods you will get some great CD Software FREE OF CHARGE! Titles will include DIGGERS and OSCAR!!! CBM's INITIAL STOCKS & EXPANSION PERIPHERALS ARE LIMITED so, call us now for your PRIORITY ORDER!!!

PHONE FOR KEENESEST PRICE!

AMiGA 4000 030 & 040 Versions

FANTASTIC NEW 68030 & 68040 MODEL AMIGA 4000's ARE NOW SHIPPING WITH A CHOICE OF MEMORY (FROM 2Mb. RAM) & HARD DRIVE CONFIGURATIONS (FROM 80Mb. to 540Mb).

Call us for the KEENESEST PRICES combined with the BEST SERVICE AROUND!

AND... Remember all our machines are UK SPECIFICATION with On-Site Warranties (This isn't always the case elsewhere!!!)

We are pleased to announce our new "LifeTime" Warranty Options

Backed by one of the UK's leading independent insurers, you can now add a Warranty to ANY Hardware item from Harwoods. You'll never be faced with an unexpected repair bill again!!! Take out up to 5 Yrs cover and at the end of that period you can extend cover annually... thus, insuring your Amiga for a LifeTime. What's more the warranty IS fully transferable & so will help you to get the best possible price should you sell your computer at any time. 5 years warranty for a new Amiga A600 would cost just £45! This new scheme IS available now even if you have purchased your hardware elsewhere! Phone for details... And stop worrying straight away!!!

AMiGA LIFETIME WARRANTY PLAN

star SJ144 THERMAL COLOUR PRINTER

NOW IN STOCK... A GREAT NEW 360X360dpi HIGH QUALITY CMYK COLOUR THERMAL PRINTER WITH LOW RUNNING COSTS... **£579.95**

Amiga Compatible Apple™ Printers

SEE PAGE 3 FOR GREAT PRICES

BLIZZARD 1200-4 UPGRADE BOARD

AMiGA FORMAT GOLD AWARD 'BEST UPGRADE' - See Page 2 for full details of this great upgrade FOR LESS THAN £170!

Buy a PowerPlay Pack for EXTRA ADDED VALUE!!!

Competition Pro 5000 Microswitched Joystick, Amiga Dust Cover, 10 - 3.5" Blank Disks, Mouse Mat, Disk Storage Box, plus...

EIGHTEEN GREAT GAMES: Xenon 2 Megablaster, TV Sports Football, Hostages, Jumping Jackson, Stir Crazy, Bubble Plus, Bloodywch, TinTin On the Moon, Krypton Egg, Purple Saturn Day, Eliminator, Skychase, Safari Guns, Lombard RAC Rally, CaptainBlood, Strike Force Harrier Sky Fox II and Lancaster

18 GREAT GAMES for only... **£34.95**

...when purchased WITH AN AMIGA or just £39.95 separately. [Note Xenon 2 Megablaster, Strike Force Harrier & Eliminator are NOT compatible with A1200/3000/4000 computers].

Buy a ZOO Pack & get both Business & Games titles!

- ZOO - Great Sonic style game!
- PINBALL DREAMS - 4 Tables!
- STRIKER - Fantastic Football!
- TRANSWRITE - Easy to use Amiga WP!

Super Low... **£14.95**

Purchased WITH AN AMIGA, or just £19.95 bought separately

BUY A HARWOODS EXTRA PACK FOR GREAT VALUE...

- TEN BLANK DISKS
- DISK LIBRARY BOX
- QUALITY MOUSE MAT
- AMiGA DUST COVER
- COMPETITION PRO MICROSWITCHED JOYSTICK

Just the pack to get you started and at a super low price... **£14.50**

Purchased WITH AN AMIGA, or just £19.50 bought separately



PRICE FLUCTUATIONS!
Please note that certain items, inc. RAM Chips (SIMMS) & their hard drives etc., fluctuate in price on the strength of the £ against the other World currencies, general supply & demand. Please ask for latest prices of any such components. Adverts are placed up to 7 weeks prior to publication & variations may occur. *Please check!*

STOP PRESS...
FREE Pen Pal worth £49.95 with ALL Citizen 240 Printers!!!
OFFER ENDS LAST DAY OF SEPTEMBER 1993!!!
STOP PRESS...
NEW STAR 360dpi FULL COLOUR LOW COST PRINTER
SUPERB HIGH QUALITY OUTPUT...PHONE US NOW!

the extensive range of peripherals & software

AMIGA MONITORS & MONITOR TV'S

All our monitors & monitor/TV's are supplied to use right away with a cable to your Amiga. A quality vinyl dust cover is FREE with monitors too!

PHILIPS PRO 2000 14" COLOUR SUPER-RES MONITOR/TV

2000 Character High Definition FST Tube, Direct SCART Lead Connection, RGB/AD, Composite Video & Direct Audio Inputs, Full FastText Teletext, Socket to plug in your Headphones, Infra-Red Remote, with Loop Aerial & FREE SCART Lead.

NOW YOU CAN COMBINE THE BEST OF BOTH WORLDS... A QUALITY DISPLAY FOR YOUR COMPUTER AND A FULL FEATURE TELEVISION SET WITH SUPERB 'MEGASOUND' ALL IN ONE!

£239.95

MICROVITEC 14" TRUE MULTISYNC COLOUR MONITOR

One for the REAL ENTHUSIAST! .28 dot pitch, built-in DMS, max res. 1024x768 (interlaced).

SUPERB QUALITY... £439.95

NEW COMMODORE 1084S COLOUR 14" STEREO

Commodore's own MONITOR PERFECT for ALL Amigas incl. all cables etc.

£179.95

NEW COMMODORE 1940 MULTISYNC 14" COLOUR STEREO MONITOR [for A1200's, 3000's & 4000's]

Commodore's own multisync monitor with .39 dot pitch

£299.95

NEW COMMODORE 1942 MULTISYNC 14" COLOUR STEREO MONITOR [for A1200's, 3000's & 4000's]

Highest res. CBM multisync monitor with .28 dot pitch!!!

£399.95

AMIGA PRINTERS

All our printers are supplied for immediate use including cable, paper & labels **FREE OF CHARGE**. Dot matrix models come with tailored dust cover. We also include specific Amiga driver disks with ALL printers **FREE**, (with Citizen models you get the excellent, new, improved Print Manager Version2) ALL Citizens have a 2 Year Warranty!!!

Please call for prices on any models not listed

120D+ Mono	£119.95
NEW Swift 90 Mono	£154.95
NEW Swift 90 Colour	£169.95
Swift 200 Mono	£194.95
Swift 200 Colour	£224.95
Swift 240 Mono	£254.95
Swift 240 Colour	£269.95
LC20 Mono	£139.95
LC100 Colour	£154.95
LC200 Colour	£204.95
LC24/200 Colour	£269.95
XB24/200 Colour	£389.95
SJ48 Mono Inkjet	£209.95

NEW STAR SJ 144 THERMAL COLOUR HQ PRINTER

Print in Mono AND Colour
Smear Free Wax Based Ink
Laser Quality 360x360dpi
OHP's, Labels, T-Shirt plus all your normal output!!!

Only... £579.95

Canon Inkjets

BJ10sx Mono £229.95
BJ20 Mono, 250cps £349.95
Includes AutoSheet Feeder
NEW BJ230 Mono, £399.95
360dpi, 248cps, with facility to print on BOTH A4 AND A3 size paper!!!

hp

510 Mono Deskjet £284.95
500 Colour Deskjet £329.95
550 Colour Deskjet £539.95

star LASERS

LS-5 £629.95
LS-5EX £749.95
LS-5TT PostScript £999.95

Phone for FREE information guide

AMIGA ACCELERATOR FOR SPEED! UPGRADABLE BOARDS

If you want some REAL PERFORMANCE from your Amiga Harwoods can offer just that. Just look at the GREAT equipment below...

SUPRA Turbo 28MHz Accelerator

Compatible with ALL Amiga A500 & A500 Plus computers. [Amiga A1500 & A2000 versions also available - Please phone and ask for details]. Simply plugs into sidecar slot of 500/Plus or the internal slot of 1500/2000's. SPEEDS YOUR AMIGA BY A FACTOR OF UP TO 4x NORMAL SPEED!

Complete with throughput for RAM or Hard Drive expansions. Ideal for improving print output speeds when using your DTP, graphical or business programs like Final CopyII, Wordworth2, DPaint etc.

Note!... in order to gain full speed benefits, your Amiga must have some FAST RAM [only Standard A500 Plus models DON'T]. Any Sidecar or GVP H.D. RAM Expansion you've already fitted is FAST RAM. Please ask for more details if you are unsure.

Raw Power x 4

1200 Performance just... **£129.95**

ACCELERATOR/CO-PRO BOARDS for AMIGA A1200

GVP1230 40MHz, 68030ec, 32-Bit	
1Mb. RAM Version	£289.95
4Mb. RAM Version	£479.95
MICROBOTICS MBX1200 RAM BOARDS	
Including Clock & Maths Co-Processor	
14MHz:	
0Mb. RAM	£149.95
1Mb. RAM	£214.95
4Mb. RAM	£304.95
25MHz:	
0Mb. RAM	£214.95
1Mb. RAM	£279.95
4Mb. RAM	£369.95
32-Bit SIMM Memory for MBX Boards:	
0Mb. RAM	£324.95
1Mb. RAM	£389.95
4Mb. RAM	£479.95

NEW! BLIZZARD 1200 Expandable Memory Board

AWARDED 'FORMAT GOLD' (SEPT. 1993 ISSUE PRODUCT REVIEW) WITH THE TOP SCORE OF 93%!!!

BLIZZARD 1200-4/8Mb Expansion & Opt. FPU

- 4mb RAM as standard & option to add a further 4Mb. Giving 1200's an extra 8Mb!!!
- 32Bit LIGHTNING FAST Zero wait state FAST RAM (normally quicker than PCMCIA cards)
- Real Time battery backed clock
- FPU socket built-in for STANDARD PLCC type Maths Co-Processors of up to 40Hz speed!!! (this is the fastest speed the standard A1200 68020 CPU can access and boards with faster CPU's normally give no extra performance)
- Easy A1200 "Trapdoor" fitting retaining Commodore Warranties intact
- Compact design utilising latest SMT (surface mounted technology) for Ultra Reliability
- Full TWO YEAR WARRANTY

BLIZZARD 1200-4Mb BOARD £169.95
4Mb. RAM Expansion £139.95
33MHz FPU Maths Co Processor £79.95

Options
BLIZZARD 1200-4Mb. Board plus 4Mb. RAM Expansion plus 33MHz Maths Co-Pro for only... £369.95

Harwoods amiga A600 & A1200 HARD DISK DRIVES

Our internal A600/1200 Hard Disk Drives are all high quality industry standard units manufactured by recognised & respected Worldwide market leaders (eg. Conner, Seagate, Western Digital etc). Each Hard Drive comes with a one year warranty, driver software, fitting kit & full instructions for you to fit yourself, And... backup and repair utility software

	Self-Fit	Fitted
80Mb	£194.95	£219.95
120Mb	£269.95	£294.95
210Mb	£379.95	£404.95

OTHER SIZES AVAILABLE...Call for details!

- If you'd prefer Harwoods to install your new Hard Drive you'll benefit from...
- Speedy collection of your Amiga
 - Fitting by Qualified Technicians, formatting, Workbench installation, hard disk configuration and pre-installation of invaluable backup and repair utility software.
 - Full 12 month HARWOODS GOLD warranty for BOTH your new hard drive AND your existing computer! (see page 3 for Gold Service details)
 - Courier Delivery back to you.

NO ONE ELSE OFFERS ALL THIS... YOU NORMALLY ONLY GET A WARRANTY TO COVER A NEW HARD DRIVE BUT NOT THE WHOLE COMPUTER!!! Probably the BEST WARRANTY available!

PRINTER accessories

We only supply original manufacturers GENUINE replacement accessories!!!

PRINTER	PRINTER TYPE	BLACK RIBBON	BLACK RIBBON 'SIX PACK'	COLOUR RIBBON	COLOUR RIBBON 'SIX PACK'
CITIZEN 120D+	BLACK ONLY	£4.75	£22.95	N/A	N/A
CITIZEN 124	BLACK ONLY	£4.75	£22.95	N/A	N/A
CITIZEN SWIFT 9	BLACK/COLOUR	£4.75	£22.95	£16.45	£94.95
SWIFT 24/24E/224	BLACK/COLOUR	£4.75	£22.95	£16.45	£94.95
STAR LC10/20/100	BLACK/COLOUR	£4.45	£23.95	£5.95	£34.95
STAR LC200	BLACK/COLOUR	£5.95 ZX9	£32.95 ZX9	£12.45 ZX9CL	£64.95 ZX9CL
STAR LC24/200	BLACK/COLOUR	£6.95 Z24	£39.95 Z24	£12.95 X24CL	£69.95 X24CL
STAR XB RANGE	BLACK/COLOUR	£8.95 Z24	£49.95 Z24	£14.95 X24CL	£74.95 X24CL
CANON BJ10e/ex/10sx CARTRIDGES	BLACK ONLY	Also compatible with Apple StyleWriter, StyleWriter II and STAR SJ 48 printers			£15.95ea.

ACCESSORIES	RIBBONS	PAINTJET...	LASER TONER CARTRIDGES
Citizen Accessories: 80 Column 9/24 Pin £37.95 Printer Colour Kit [ALL models except the Citizen 124 model] £13.95 32K RAM Expansion [24Pin Citizens except 200/240] £19.95 32K RAM Expansion [Citizen 200/240] £19.95 128K RAM Expansion [Citizen 200/240] £32.95	Hewlett Packard Original Consumables DESKJET 500... £21.95 Black Ink Cartridge [Double Life] £27.95 Colour Ink Cartridge [Standard] £27.95 Please phone for any item not shown in our listings	PAINTJET... Black Ink Cartridge £26.95 Colour Ink Cartridge £28.95 Single Sheet Paper £18.95 Z-Fold Paper £20.95 Transparency Film: [Pack of 50 Sheets] £49.95	LASER TONER CARTRIDGES We stock MOST types at really competitive prices...PHONE!!!

A500 + HARD DISK DRIVES

Simply plug into Amiga sideport

A1500 A2000 INTERNAL HARD DRIVES

Simply plug into internal slot

GVP 68882 Maths floating point unit for A530's

GVP MEMORY UPGRADES

HC8 & HD8 Drives add EXTRA RAM - 2Mb. SIMM chips at a time simply plug in 32-Bit SIMM chips for GVP Accelerators [min. 2Mb. at a time, 32-Bit chips]

PHONE FOR EVERYTHING GVP AT GREAT PRICES!!!

0773 836781

*Finance Facilities Available,

AMIGA

0773 836781

GOLD SERVICE

COMPARE OUR GOLD SERVICE

Before you choose from whom to purchase, please phone us. We are always happy to discuss your requirements and answer any queries you may have. And... remember Harwoods have always provided **THE BEST** service in the industry...

FREE GOLD SERVICE: Any computer, monitor or printer that requires service in the first year is collected **FREE OF CHARGE** (UK Mainland only). Remember at Harwoods we charge no more for this GOLD service. The fastest turnaround possible is **GUARANTEED** by our **OWN SERVICE ENGINEERS**. Many items have In-Home Warranties - **TECHNICAL SUPPORT:** You will be given our Exclusive Technical Support Phone Number to call should you require any help or advice on any aspect of the system you have purchased. **MINIMUM 12 MONTH HARDWARE WARRANTY:** Items proving faulty within 30 days of purchase are replaced with **NEW UNITS** unless otherwise stated. For the guarantee period, warranty service will be completely **FREE OF CHARGE** (some items are 2 yr warranty). **YOUR SYSTEM READY TO GO:** All main hardware products come with mains plugs and leads - just connect up and use straight away.

How to contact us...

BY PHONE: Phone our Order Hotline with your Access, Visa, Mastercard Switch or Lombard Creditcharge Card quoting number & expiry date (Most Dixons, Currys, NASCR and other 'store' cards are Lombard Creditcharge and are happily accepted by us).

BY POST: Make cheques, bankers building society drafts or postal orders payable to **GORDON HARWOOD COMPUTERS**. (Personal/business cheques take 7 days to clear from day of receipt whereupon your order will be despatched). Please send Name, Address, and most importantly if possible, a Daytime Telephone Number along with your order requirements. Please check you are ordering from our latest advertisement before posting (phone if you require confirmation). Please remember that for example many September publications appear during August, etc., therefore prices you see may have changed (either up or down!).

EXPORT: Most items are available at **TAX FREE PRICES** to non UK residents and service personnel. Please contact us for confirmation of export prices before ordering.

FREE DELIVERY: by Parcel Force, UK Mainland only. OR **SPEEDY NEXT WORKING DAY COURIER SERVICE.** Add just £6.95 per major item for guaranteed delivery (for £10.00 for Saturday delivery). UK Mainland most regions. (Despatch normally on day of order or payment clearance).

All listed prices are what YOU PAY, and there are **NO HIDDEN EXTRAS**. VAT and postage are included, and prices are correct at time of going to press (Pack details may vary from time to time). Offers and Services are subject to availability and to being the latest advertised products, packs and prices. Please note goods are not supplied on a trial basis. E&OE.

VISIT OUR SPACIOUS SHOWROOM:

Why not take a trip out to visit us and see our full advertised range, and more, available at the **SAME COMPETITIVE PRICES**. (Please see opening times) There's plenty of **FREE** parking nearby too!

How to find us...

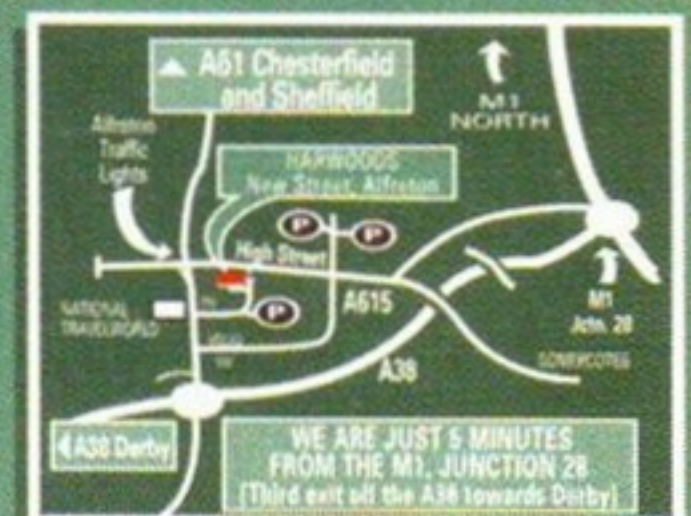

OPENING TIMES
9.00 until 5.00 Monday to Saturday
Wednesdays - 9.00 until 1.00

GORDON HARWOOD Computers

Enquiries & Order Line:
0773 836781

Finance Facilities Available*

*Please phone us for information, your personal application pack and full written details.



GORDON HARWOOD COMPUTERS
DEPARTMENT amf/H11, NEW STREET,
ALFRETON, DERBYSHIRE. DE5 7BP
TEL: 0773 836781 FAX: 0773 831040

The Closer you look, The Better we look

AMIGA accessories

sound & graphic DIGITISERS	Colour Pic Plus	£679.95
	Super Pic	£579.95
	Rombo Vidi 12, V2.00	£74.95
	Vidi 12 & Sound & Vision	
	MegaMix Master	£94.95
	Amas 2 Sound Sampler & Midi Interface inc. Microphone	£74.95
	Audio Engineer Plus	£179.95
	Audio Engineer Plus 2	£249.95
	Technosound Turbo Sampler	£29.95
	NEW Technosound Turbo 2	£44.95

MUSIC	Miracle keyboard	£299.95
	Music X full version 1.1	£24.95
	Midi interface 5port c/w cable	£24.95
	Super JAM	£79.95
	Bars & Pipes Pro 2	£244.95
	ZYFI Stereo Speakers	£39.95
	ZYFI Pro Stereo Speakers	£54.95
	Clarity 16	£109.95
	Stereo Master	£29.95
	Power Mono NEW V3.0 Hand Held Scanner	£109.95
	Power Colour Hand Held Scanner	£239.95

SCANNERS	ProGen - Perfect high quality entry level true video signal genlock	£64.95
	Rocgen Plus	£139.95
	Rendale 8802 inc switch and fader controls, A1200	£179.95
	HQ Microswitched MEGA MOUSE excellent magazine reviews...	£12.50

AMIGA MICE	HQ Microswitched 400dpi Resolution MEGA MOUSE	£15.95
	HQ Microswitched MEGA MOUSE inc. Mouse Mat & Holder	£19.95
	High Quality micro-switched Optical mouse	£28.95
	HQ Microswitched Trackball	£29.95
	Automatic Mouse and Joystick Switcher	£17.95

IBM PC emulators	GVP 286 PC Emulator for your GVP A500 HD8/530...	£99.95
	Premier Control Centre & Monitor Plinth with shelf:	

monitor STANDS	For Amiga A500	£39.95
	For Amiga A600	£34.95
	For Amiga A1200	£39.95

JOY sticks	Zipstick autofire	£11.95
	Competition Pro-Star autofire, burstfire & slow motion	£13.95
	Python 1M	£10.95
	The 'BUG' Microswitched	£14.95

DISKS STILL AT LOW PRICES!!!	10 TDK 3.5" DS DD	£7.95
	50 TDK 3.5" DS DD	£32.95
	10 TDK 3.5" DS HD	£12.95
	Certified Bulk Disks with labels:	
	10 with library case	£6.95
	50 Disks - only...	£24.95
	100 Disks - only...	£39.95
	250 Disks - only...	£94.95
	3.5" Disk Head Cleaner essential for reliable loading	£2.95

for MORE ACCESSORIES... Please Phone us!!!

NEW MOUSE MECHANIC	Fantastic Universal Mouse Cleaning Tool	
	Cleans in Seconds, Needs No Fluid Use again & again	£4.99

AMIGA FLOPPY DISK DRIVES

ROCLITE 3.5" ANTI-VIRUS External 3.5" Drive Built-In Anti Virus Checker & FREE Head Cleaning Kit	POWER XL HIGH DENSITY DRIVE 3.5" High Density Drive (extra storage) and... FREE Head Cleaning Kit	CUMANA 3.5" External 3.5" Drive ThroughPort, Extra Long Cable and... FREE Disk Head Cleaning Kit
NEW LOW PRICE £59.95	£99.95	£Phone!

AMIGA RAM CARDS & SMART CARDS MEMORY UPGRADES

TRAPDOOR UPGRADES	Amiga A500 1/2Mb.	£32.95
	Amiga A500+ 1Mb.	£39.95
	Amiga A600 1Mb.	£47.95
SMART CARD UPGRADES	A500 & A600 RAM expansions inc. Battery Backed Real Time Clock	
	PCMCIA CARDS for A600/1200	
	PCMCIA, 2Mb.	£119.95

Amiga Compatible Apple™ Printers

Apple™ equipment has always had a reputation for its quality and reliability...but, at a price! NOW you can use Genuine Apple™ Printers with your Amiga at far **MORE COMPETITIVE** prices than you'd imagined was ever possible...

Apple™ Personal LaserWriter™ NTR 4ppm Canon engined laser with superfast RISC Processor & 3Mb RAM (upgradable to 4Mb). True PostScript™ Level 2. HP LaserJet™ & PCL 4+ emulations. FULLY Amiga & PC compatible. Parallel, Serial RS232 & LocalTalk interfaces built-in. No other laser of this quality costs so little... £739.95	Apple™ Color A3/A4 BubbleJet Canon BJC 820 engined 360x360dpi BubbleJet. EpsonQ 24Pin emulation. Parallel & SCSI interfaces. A3 & A4 size paper. Up to 300cps in text mode! INFINITE COLOUR OUTPUT using a 4 colour CMYK system of ink cartridges with approx. 700page life. There's no better inkjet at only... £1199.95
--	--

Call for your Apple Printer Brochure NOW

Remember we also supply the full range of Macintosh® computers, from a Classic® to a Quadra® for personal callers... Telephone: **0773 521606 now!** Authorised Reseller®

AMIGA +xabc educational software

mega maths - A level	£19.95
ADI titles available for ages 11 to 12, 12 to 13, 13 to 14 or 14 to 15 (please specify)	
ADI english (not 14to15 age group)	£18.95
ADI maths (specify from ages above)	£18.95
ADI french (specify from ages above)	£18.95
micro science - to GCSE standards	£18.95
micro maths - to GCSE standards	£18.95
micro english - to GCSE standards	£18.95
micro french - to GCSE standards	£18.95
micro german - to GCSE standards	£18.95
primary maths - 3 to 12's	£18.95
compendium six (6 great programs)	£27.95
reading and writing course - over 3's	£18.95
fun school 2 - Ages 2 to 6, 6 to 8, over 8's	£5.95
fun school 4 software: (choose from - under 5's, 5 to 7's or 7 to 11's, please specify)	£18.95
noddy's playtime (3yrs and over)	£18.95
NEW...Childs Play Activity Centre and Word Processor with SPEECH, 2 to 12yrs	£24.95

Lots More available... Please telephone us!!!

AMIGA software

WORD PROCESSING AND PUBLISHING	Pen Pal V1.5	£49.95
	Final Copy II Release 2	£99.95
	THE BEST WORD PUBLISHER	
	Kindwords 3	£39.95
	The Publisher	£39.95

INTEGRATED TITLES	Professional Page V4.0	£129.95
	Pagesetter III	£47.95

DATABASE SOFTWARE	Wordworth	£39.95
	Homebase	£15.95
	Superbase 2 Personal	£29.95

CAD & Structured Drawing	Gallery Pictorial Slide Show/DB	£29.95
	X-CAD 2000	£97.95

VIDEO SOFTWARE	X-CAD 3000	£254.95
	Art Expression	£144.95
	Expert Draw	£49.95

MISCELLANEOUS SOFTWARE	Video Master	£52.95
	Scala 500	£74.95
	Scala Professional	£177.95
	Broadcast Titler 2	£244.95
	GB Route Plus	£34.95

ANIMATION AND GRAPHICS	Voyager	£54.95
	Turboprint Pro 2.0	£34.95
	Mavis Beacon...	
	Teaches Typing	£22.95
	Workbench Upgrade Kit	£79.95
	Action Replay III	£57.95
	Softfaces 1 to 4	£39.95
	Softclips 1 to 4	£29.95
	Softwood Proper Grammar 2:	£39.95
	Grammar checker, for ALL those	

AMIGA DEVELOPMENT AND UTILITIES SOFTWARE	Amiga Word Processors	£119.95
	TypeSmith	£54.95
	System 3E	£59.95
	Cashbook Combo	£29.95
	Personal Finance Manager	£94.95

AMIGA GAMES	Arena Accounts	£84.95
	Deluxe Paint 4.1	£74.95
	Deluxe Paint 4 (AGA)	£36.95
	3D Construction Kit	£57.95
	Adorage	£29.95
	Vista Pro 2	£54.95
	Vista Pro 3	£62.95
	Scenery Animator	£149.95
	Art Department Prof. V2.3	£349.95
	DCTV Composite Video	£149.95

AMIGA DEVELOPMENT AND UTILITIES SOFTWARE	24-Bit Graphics System (PAL Version)	£149.95
	Morph Plus	£39.95
	Studio	£74.95
	Real 3D Classic	£364.95
	Real 3D 2	£147.95
	Brilliance	£149.95
	Pixel 3D Pro + Anim Workshop	£149.95
	Quarterback V5	£51.95
	Quarterback Tools	£47.95
	Quarterback Tools Deluxe (Advanced Disk/File Management)	£99.95

Phone for a massive choice of competitively priced entertainment software!!!

AMIGA BOOKS	PC Task - PC Emulator	£37.95
	Cross DOS	£34.95
	Easy Amos	£24.95
	Amos The Creator	£36.95
	Amos Compiler	£21.95
	Amos 3D	£25.95
	Amos Professional	£36.95
	Amos Professional Compiler	£24.95
	New SAS Lattice C V6	£239.95
	Devpac 3	£52.95

AMIGA BOOKS	Directory Opus V4	£49.95
	Can Do 2	£99.95
	Amiga A1200 Insider Guide	£14.50
	Amiga A600 Insider Guide	£14.50
	Mastering Amiga Assembler	£21.95
	Mastering Amiga Beginners	£18.50

ABACUS books also in stock please phone for prices!

ALL PRICES ARE INCLUSIVE OF



FROM THE DIRECTOR'S CHAIR

RON THORNTON WORKS for a company we have featured before in *Amiga Format*, Foundation Imaging. He is part of the team responsible for the stunning effects used in the American sci-fi series *Babylon 5*, and all that work is created on the Toaster. We asked Ron for his professional view of the Toaster and, more importantly, his opinion of the brand new Toaster add-on, the Screamer. This is what he had to say...

TOASTERS, SCREAMERS AND SPACESHIPS

It sounds rather too good to be true, *Star Wars* effects at *Dr Who* prices, but you'd better believe it. The Video Toaster from NewTek is beginning to have an impact on the Hollywood effects industry. It is over a year now since the two-hour pilot of



Realistic motion blur makes *Lightwave* behave more like a movie production facility than just a rendering package.



Copyright Foundation Imaging 1993



Geometry and image created by Ron Thornton 1993

Come on Gerry, Ron's number is 805 257 0292 and he is just waiting for your call.

Babylon 5 was in production. At the time *B5* was unique in being the only television show to have all its visual effects created on personal computers. Now they're all at it. Even Stephen Spielberg has set up a Video Toaster facility after laying down \$15 million on the spectacular computer graphic images for *Jurassic...* er, what's it called?!

Spielberg's TV show, *Seaquest DSV*, is due in the UK by the end of this year and boasts an enormous number of Toaster-generated effects, and under the guidance of Jim Lima (the FX designer) should be amazing.

Babylon 5 has been picked up for a season of 22 episodes, and promises to break some new ground in the genre of TV sci-fi (I should know, I've read the scripts).

The Amiga has been around for a long time, so why hasn't Hollywood picked up on it 'til now? The answer is software. I have owned an Amiga since 1988 and dabbled a little with 3D. The main problem was that the software was designed for tinkerers and hobbyists. One developer punctuated a tech support call I had made with "Hey, what do you expect for £199?".

The *Lightwave* model for the main image of the *Babylon 5* space station occupied over 30Mb of disk space, which isn't that surprising considering there are over 200,000 polygons in it. The image on the right is a bit smaller, but still you can understand why Ron uses 20 Toasters to produce his visuals.

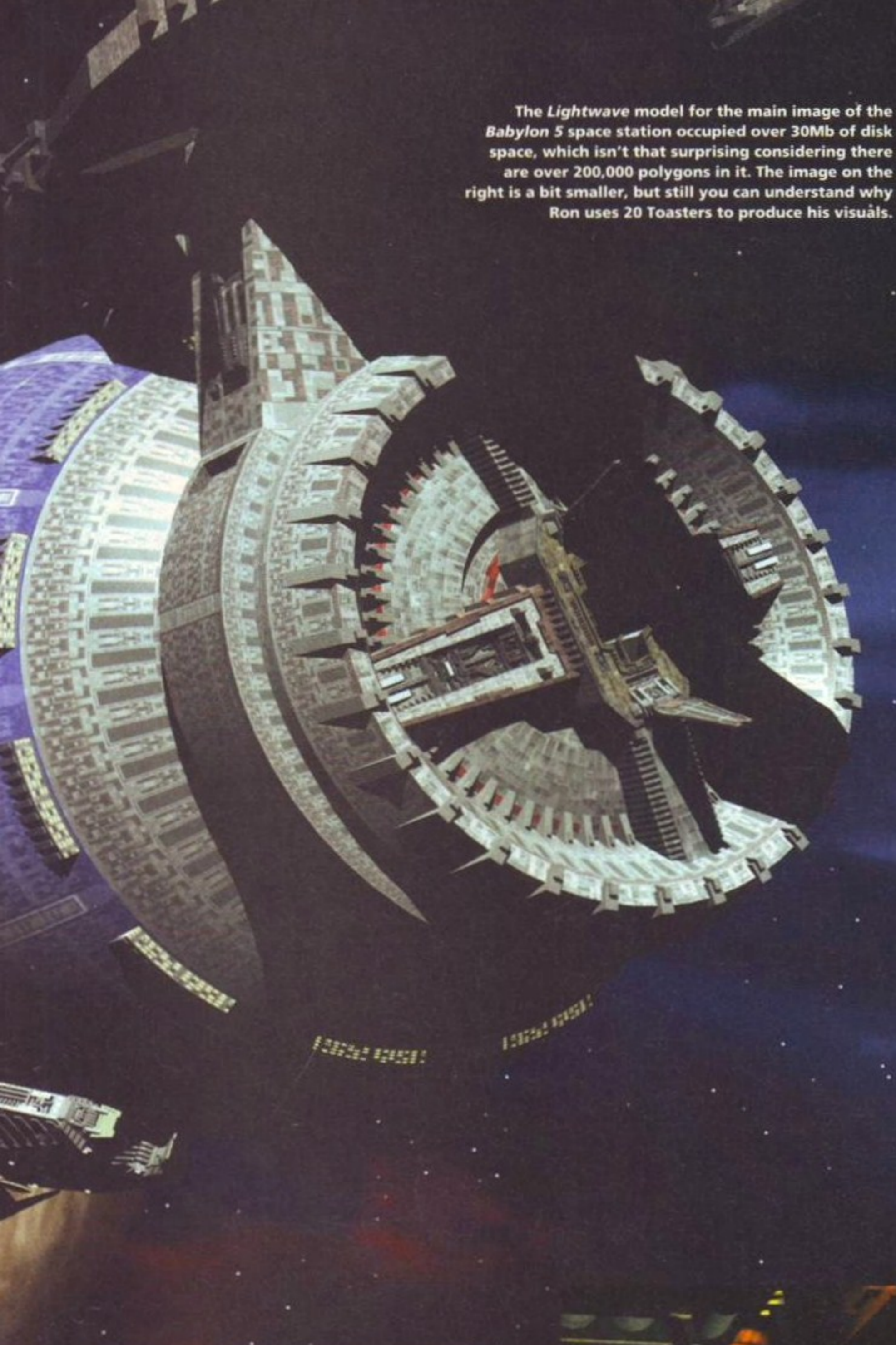

Copyright Foundation Imaging 1993

clone servers and rendering scripts. This is no longer a one-man tool.

NewTek has its HQ in Topeka, Kansas, a city half the size of Tunbridge Wells, where the spiciest food is ketchup. This must explain the state of mind of the company whose research and development department has voluntarily adopted the name Alcatraz. So when they call you and say: "Would you like a machine twice as fast as a Cray One, that runs *Lightwave*, for only \$10,000?" I just mop up the drool and say "Gimme!".

Suddenly you have rendering power that makes Silicon Graphics Indy look like a VIC20. With 600 MIPS (million instructions per second), the Screamer will render about 40 times faster than a stock Amiga 4000/040. It's a network in a box - four MIPS RISC4400 motherboards controlled by a Video Toaster4000. No wonder the fashion computer manufacturers are in a tizzy. The announcement of the Screamer at '93 Siggraph caused the guy sitting next to me to say "600 MIPS? That's a typo, man".

The fact that the Toaster and Screamer are both NTSC native machines need not matter. ASDG's *Art Department Professional* now has a PAL Abekas saver which means you can stick it to the fashion boys anywhere with your desktop Cray.

So how about it Gerry, want to do *Thunderbirds* again with computer graphics? FAB!

Continued overleaf ➤

Needless to say the package in question went into the bin with all the rest.

To prevent further aggravation I made a rule for myself. If I can make and render something in 30 minutes without looking at the manual I'll buy it. The next package I bought was the Toaster. At last, not a toy but a tool!

Lightwave (the Toaster's 3D rendering package) is an amazing piece of software, mainly because the programmers, Allen Hastings and Stuart Ferguson, are frustrated film makers. They wrote the package to make their own movies. The user interface vocabulary is film related, not geek speak.

Toaster 4000 contains the latest evolution of *Lightwave*, sporting features such as Lens Flare and Bones (an animatable displacement of geometry that usually costs around \$60,000 to do).

The major drawback with the Motorola 68040 machines is speed. The fashion CGI facilities are always quick to point out that even though the quality is good, the speed is not. They are right of course, so we buy 20 68040s. The problem is partially fixed by using a network of multiple cheap CPUs. Now you get into Novell Netware, IBM



Copyright Foundation Imaging 1993

The excellent lighting effects in this shot are a testament to *Lightwave's* superb ability to reproduce realistic images.

STOP PRESS

We have just learnt that Ron and the people at Foundation Imaging have just won an Emmy award for their computer graphic effects in *Babylon 5*. Well done guys!



THE FINAL CUT

WHERE'S THE ROASTER?

The Toaster is currently a leader in a field of one. No other product offers the same facilities for a comparable price, but this may soon change. The Australian development team who bought us the AF Gold-rated OpalVision system have been working feverishly to build a set of add-on modules for this 16 million colour card. Apparently, they will offer facilities comparable, if not superior to the Toaster, with a wide range of live video effects and genlock facilities. What's more, it's designed to work in PAL mode, so you won't need extra hardware to get it to work in the UK.

It sounds excellent, but it's not here yet. Some of the effects included in the modules were demonstrated at the World of Commodore show in Australia, but nobody has yet seen the finished version of the modules, and distributors Centaur Developments have repeatedly moved the release date back. Once the modules are finished, rest assured *Amiga Format* will do a full review, including a comparison with the Toaster.



It's not cheap, but it may be the only way we ever see Toaster generated graphics on European TV.

THE TOASTER MAY be a stunning bit of equipment, but you can't just plug it in and use it in your Amiga unless you are reading this in the US or Japan. When the engineers at Newtek planned the Toaster, they decided to base it around the NTSC (National Television Standards Committee) standard, as used in the United States and Japan. So, when they designed the complex chips that make up the toaster, they designed

them to work with this type of TV signal. This means that the Toaster can only accept an NTSC input, and also outputs an NTSC signal. Unfortunately, the standard used in the UK and Europe is completely different.

Video equipment in the UK uses the PAL (Phased Alternate Line) standard, which isn't compatible with the NTSC one. So if you want to use a Toaster in the UK, you need to convert all of

your video signals from PAL to NTSC before you feed them into the Toaster. Once the Toaster has had its evil way with the signal, you need to convert its output back to a PAL signal for you to feed into your monitor or video recorder. What is needed is a device called a standards converter,



This is a still from the Video Toaster demonstration tape, which was converted from a NTSC original by the Prime Image standards converter.

which can take a PAL signal and convert it into a NTSC one (or vice versa). To use the full facilities of the Toaster, at least two of these (one for the input, and one for the output), or possibly three (one for each of the two inputs) will be needed.

THE PRIME FACTOR

American video equipment manufacturers Prime Image have recently released a new standards converter, which promises to bring toasting to the UK at a reasonable price. It's a full length card which fits into any of the PC slots in a big-box Amiga (the A2000, 3000 or 4000). Previous standards converters have cost several thousand dollars, and have involved a great loss of quality because of the conversion. The Prime Image model uses a new technique to convert the signals (called Comb Through). Most converters work by taking an average of the video signal, and creating the new signal from this.

This process leads to the 'fuzzy' appearance you see with videos converted to PAL from NTSC, especially on one of the many domestic video recorders which can play back NTSC tapes. The Prime Image converter gives much better quality than these, because all of the image conversion is done using digital circuitry. The incoming image is converted to an 8-bit digital signal, and this is then processed and converted by the card.

This card also acts as a time base corrector. If you want to feed two signals into a toaster, they need to be time base corrected. This means the various timing signals included with the signal (which include things like when to jump back to the top of the screen) need to be synchronised.

THE PRICE OF TOAST

Creating a PAL Toaster set-up isn't going to be cheap, but compared to the cost of conventional video equipment it makes financial sense. You're not going to get the same quality as equipment designed especially for use in PAL, but from what we've seen of the quality of the converted image, it's good enough for use in a home or semi-pro set-up. Rest assured that *Amiga Format* will bring you a full review as soon as we can.

The Std Com/PCB standards converter is made by Prime Image (0101 408 867 6519) and distributed in the UK by Vortex (081 579 2743).

The BBC Radio 1's
TV and Radio presenter

INDI DIRECT MAIL

Proudly Presents

THE

JAKKI BRAMBLES COLUMN



INDI IS A MEMBER OF THE DMA

As with most industries, the UK's personal computer industry has its share of cowboys operating in the mail order sector and at the receiving end a line up of despairing consumers who have suffered at their hands.

A personal computer is a sophisticated and expensive item and provided the purchaser is dealing with a reputable and accredited supplier, buying a computer by mail order can be a perfectly safe and cost effective exercise. The Direct Marketing Association (DMA) was set up in April 92 to set and maintain high standards for the sake of the industry and society at large, and to ensure that we can continue to regulate our own activities on the basis of proper professional responsibility.

Membership of the DMA is not conferred lightly - it is a privilege which entails responsibilities, to the consumer as well as to the industry. The foundation for this must be good practice. DMA members are required to abide by the highest standards as laid down in the DMA's code, enforced on members by The Authority of the DMA a separate body with an independent Chairman, and which is an assurance of vigorous self-regulation and professional responsibility. DMA members also agree, as a condition of membership, to abide by The British Code of Advertising Practice and The British Code of Sales Promotion Practice: to apply the Mailing Preference Service file when appropriate: and to subscribe to the Advertising Standards Board of Finance (ASBOF) and to the Mailing Standards Levy as applicable. The DMA symbol can only be used by members. Printed on stationary, advertising and other promotional material it demonstrates that these companies conform to the Association's high standards and are subject to the DMA's Code of Practice, thus enhancing the companies credibility with customers, suppliers and of greatest importance, the consumer.

Since the symbol was introduced last June, it has become synonymous with quality, professionalism and responsibility. While it cannot be shown in any way which will become a sign of best industry practice and of strict adherence to DMA codes of conduct. The symbol represents authority for members and reassurance for consumers. It has been a high valued mark of confidence signifying to the consumer the truly professional edge of the industry.

Alison Slan
(Director of Public Relations, DMA)



AMIGA CD³²

FREE SOFTWARE

Lemmings, Oscar, Diggers



ONLY
£289.99
with 3 great
titles

The exterior may be sleek but lurking inside the Amiga CD32 is a technological wonder. At its heart is the mightily powerful 68EC020 processor from Motorola. This contains the 32-bit technology which has made the Amiga 1200 a runaway success throughout Europe. Alongside it is Commodore's unique custom AGA (Advanced Graphics Architecture) chipset - comprising three chips nicknamed Paula, Lisa and Alice. Together they make Amiga CD32 and awesome powerhouse of high speed graphics and stunning sound capabilities. In fact, the machine can display 256,000 colours on screen (compared to Sega's Mega CD which can only display 64) and has a total colour palette of 16.8 million colours. Amiga CD32 also comes with a chunky 2 Meg of RAM (that's 15 times more than Mega CD) and a double speed drive.

SPECIFICATIONS:

- * 14 MHZ 68EC020 processor
- * 2 Megs 32-bit chip RAM
- * 2 Joystick ports/controller ports
- * S-video jack
- * Composite video jack
- * RF output Jack
- * Stereo audio jacks
- * Keyboard connector/ auxiliary connector
- * Full expansion bus
- * Headphone jack
- * Headphone volume control
- * External brick power supply
- * Internal MPEG FMV expansion capability
- * Multiple session disc capability

Hi, It's been quite a month in the Commodore marketplace, no sooner had we all been told that Commodore had lost their shirt than we have been inundated with masses of good news.

First we have the launch of **two brand new Commodore Amiga 1200 packs** one aimed straight for games market the other firmly at the more mature purchaser. **The Chartbuster Pack** is great value bundled with Nigel Mansell's World Championship race simulator, Trolls AGA and the all time favourite Amiga Challenge Pack. **Desktop Dynamite** reinforces the all round strength of the A1200 with a very powerful package based around Wordworth AGA, Print Manager, Deluxe Paint IV AGA, Oscar AGA and Dennis The Menace AGA.

It's good to see Commodore create such a clear distinction between the Amiga 1200 market and the games console market, soon to be dominated by the Amiga CD32.

As I write this article the first of the CD32's are about to land in the UK with a promised street date launch of the **first week in September**. The major news around this product is just how many of the software publishing houses are enthusiastically writing for it and of course that Commodore have decided to bundle 2 great software titles at launch.

Not to be outdone **INDI have added a third** so look forward to receiving Oscar, Diggers and Lemmings when you take delivery of your New Amiga CD32.

The other item of news from Commodore does appear to be causing some confusion. It is true that Commodore have appointed the giant ICL company to look after the warranty on their products but this only applies to Amiga CD32 and the Desktop Dynamite Pack. All other products and packs previously purchased or yet to be purchased will be covered by Wang.

Finally it was very sad to hear this week of the demise of Diamond Computer a well known advertiser in the Amiga Market. There is no doubt that the recession continues to cause the closure of many companies often without warning. Once again please be careful with your hard earned money and make certain that you follow the code printed in most magazines before you make that special purchase.

See you next month.

INDI MULTI MEDIA CLUB

A true 'One Stop Shop' for all members. On offer each month with an ever increasing product range, members can obtain software to cover every application including **Morphing, Rendering, Raytracing, Video** and a PD Library second to none. The Club also offers a very comprehensive range of videos including the **Cult Manga Titles, Music, Features and Special Interest**. There really is something to suit every one's taste. Membership costs only £10 and each member receives a quality gift on joining, even though there is absolutely no commitment to buy at any time. If you would like to be a part of this exciting club then call **Indi on 0543 419 999**

***PAY 10% NOW AND NOTHING MORE FOR 3 MONTHS**
***ORDERS OVER £200 SUBJECT TO STATUS**



NEW AMIGA PACK

CUSTOMER CHARTER

INDI Direct Mail is original and very exciting. Before you buy mail order you must first be confident that you will receive the product you've ordered and that the supplier still be there in the future, should you need them.

A mail order purchase from INDI is a safe and secure decision, and here's why.

INDI is a wholly owned subsidiary of a public company now in its tenth year of trading and specialising in the supply of computer products.

With a turnover approaching £30 million per annum, we have the resources and the purchasing power to offer you the best deals, deliver them next day nationwide and always be around when you need us. The INDI sales team have been trained to

SALES AND SUPPORT

take your order with the utmost care and efficiency. All stock offered for sale is held in stock, centrally at our group warehouse complex and is available for next day delivery, direct to your home or business. If at any time we are out of stock your money will not be banked until the product is available (a point worth checking should you be tempted to purchase elsewhere)

General information regarding product is available from our sales team, however technical support is always on hand should you need assistance.

All prices quoted are inclusive of VAT.

INDI TELESales
 TEL 0543 419999 FAX 0543 418079
 9am - 7pm Monday to Friday
 9.30am - 4.30pm Saturday.

CREDIT FACILITIES

INDI are now able to offer competitive credit facilities on all orders over £200. All credit facilities are subject to status and applicants must be over the age of 18.

If you would like a quote simply call our sales line where acceptance can normally be notified within the hour. We are also able to offer Credit Insurance to cover repayments in the event of sickness or unemployment.

AMOUNT OF CREDIT	12 MONTHS		24 MONTHS		36 MONTHS	
	MONTHLY PAYMENTS	TOTAL PAYABLE	MONTHLY PAYMENTS	TOTAL PAYABLE	MONTHLY PAYMENTS	TOTAL PAYABLE
200	£22.00	£264.00	£12.00	£288.32	£9.31	£335.63
500	£54.99	£659.88	£31.06	£745.44	£23.27	£837.72
1000	£109.98	£1319.76	£62.13	£1491.12	£46.54	£1675.44

APR 29.9% WRITTEN QUOTATIONS AVAILABLE ON REQUEST
 *After deposit paid

AFTER SALES AND SPECIALIST SERVICE

All products are guaranteed for 12 months. Some products carry a 12 months at home service and repair guarantee (where indicated). In the unlikely event that any product purchased from INDI arrives at your home faulty, we will collect from your home and replace the product completely free of charge.

As part of our policy of continual product development and refinement, we reserve the right to change specifications of products advertised. Please confirm current specifications at the time of ordering.

Prices are valid for month of publication only.

AMIGA A1200



AMIGA 1200 CHARTBUSTER PACK

AMIGA 1200 SD

- * Nigel Mansells World Championship Racing
- * Trolls
- * Amiga Challenge Pack

PACK INCLUDES: * International Sports Challenge
 * Paradroid 90 * Cool Croc Twins * Indianapolis 500

£289.99 or from **£11.04*** per month

*(Credit price based on 36 monthly payments APR 29.8%. Total repayment £397.92 and 90 day deferred payments.

80 Mb and 120 Mb Hard Disk upgrades available on any A1200. Upgrade does not invalidate your Wang or ICL warranty on A1200 and Hard Disks. Phone for a quote.

NEW DESKTOP DYNAMITE PACK

This great new pack from Commodore must have at least £300 worth of software bundled with it.

A1200 STANDARD FEATURES.

- * 68020 Processor * PCMCIA Slot * 2MB Chip RAM * 3.5" Internal Drive
- * AA Chipset * Built in TV modulator * Alpha numeric keypad.
- * 12 Months at home maintenance.

FREE

- * Wordworth AGA * Print Manager * Deluxe Paint IV AGA * Oscar AGA
- * Dennis The Menace AGA

INDI PRICE

£339.99 or from **£12.95*** per month

*(Credit price based on 36 monthly payments APR 29.8%. Total repayment £466.20 and 90 day deferred payments.

NEW LOW PRICE HARD DRIVE OPTIONS

A1200 80 MEG HD INDI PRICE ADD £200.00
A1200 120 MEG HD INDI PRICE ADD £230.00

OFFICIAL A1200 HD SYSTEMS

The Amiga 1200 supplied by Indi Direct Mail now includes the official (legal) Commodore installation disk and hard drive utility manual. Indi are proud to be an official supplier of Amiga 1200 Hard Drive systems, that include the official software, documentation and on-site warranty.

AMIGA A4000



FREE INDI GRAPHICS PACK

It's here - The new Amiga 4000/030

The NEW Amiga 4000/030 features a EC68030 processor running at an incredible 25Mhz, and upgradable at a later date to a faster processor. The 4000/030 has a powerful 2 Mb of 32-bit RAM expandable to 18 Mb using industry standard 32-bit Simms module. In line with the Amiga flagship 4000/040 the 4000/030 features the new AGA graphics chipset, giving you a massive pallet of 16.8 million colours. A range of hard drive options are available from 80 - 240 Mb and includes a SCSI option.

4000/030 80 Mb HD INDI PRICE £899.99

Other Drive Options

4000/030 120 Mb HD INDI PRICE £959.99

4000/030 240 Mb HD (exclusive to INDI)

Phone for price.

4000/030 120 Mb SCSI HD (exclusive to INDI)

Phone for price

A full range of approved upgrades are available for the 4000/030, including additional memory modules, hard drives, PC bridge boards, FPU's (68881 & 68882) and the 24-bit Opal Vision graphics and video system

INDI GRAPHICS PACK (FREE WITH ALL A4000'S)

PD C - light, Graphic Utilities, Ray Tracing and Rendering package pre loaded on to your Hard Drive.

NEW MONITOR RANGE

THE NEW DUAL SYNC 1942 Monitors have been specially designed for the New Amiga 1200 and 4000 computers. Both monitors feature built-in stereo speakers.

INDI PRICE

1940 Monitor £269.99

14 inch screen size - 0.39 mm dot matrix

INDI PRICE

1942 Monitor £369.99

14 inch screen size - 0.28 mm dot matrix



Parnet Adaptor for CDTV

Connect a CDTV player to any Amiga, and access the world of CD-ROM software. The Parnet interface and software will allow the Amiga CDTV to be used as a CD-ROM drive with any Amiga and will give any Amiga owner access to the vast range of CDTV software currently available.

The CDTV player offers excellent value for money when compared with a standard CD-ROM drive and interface. Most CD-ROM drives will set you back over £400 while CDTV will cost you less than £300 and will play audio CD's in addition to CD-ROM / CDTV disks your Amiga, interface cable and PD disk with driver software for your CDTV player. (The Parnet adaptor can be used to link any Amigas together)

INDI PRICE £39.99

CDTV MULTI MEDIA + PARNET. INDI PRICE £289.99



ZAPSAC AND T - SHIRT
INDI PRICE £17.99

AMIGA A600 PRICE CRASH

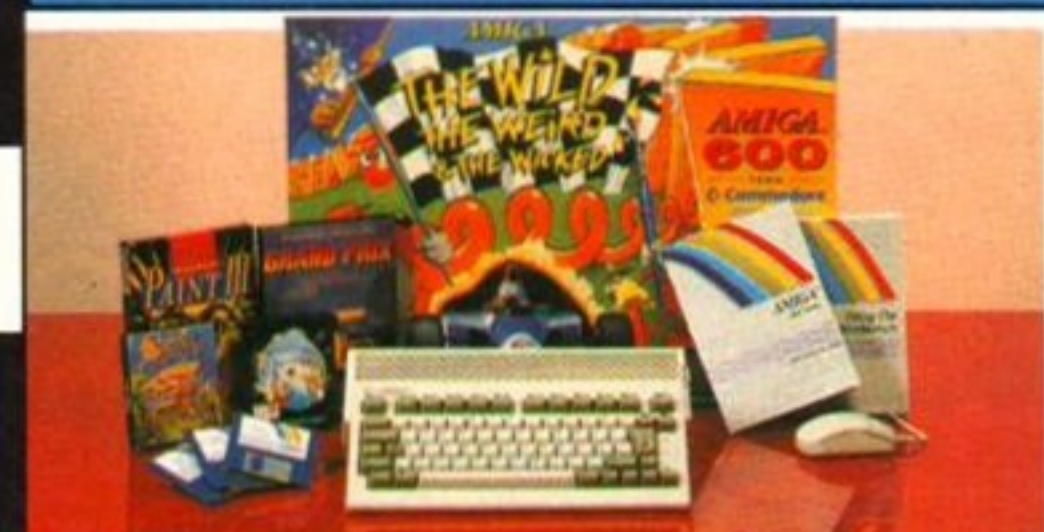

THE WILD THE WEIRD AND THE WICKED A600 is an ideal starter pack containing a considered mix of software, making the most of the Amiga's capabilities.

PACK CONTAINS:

- * A600 Single Drive
- * Built in TV Modulator
- * 1 Mb Memory
- * Pushover: Grandprix
- * Silly Putty: Deluxe Paint III
- * Mouse and Manuals

NEW LOW LOW PRICES
~~£215.99~~
£199.99

A600 - SD A single drive Amiga for those of you requiring a basic A600 at a very competitive price.
PACK INCLUDES: A600 single drive, built in TV modulator, 1 Mb memory. 12 Months at home service

INDI PRICE

~~£189.99~~

£169.99

A600 EPIC PACK (40 Mb HD) PACK INCLUDES:

- * A600 Hard Disks (40Mb) * 1 Mb Memory * Epic * Rome * Myth * Trivial Pursuit * Amiga Text * Deluxe Paint III * 12 Months at home service.

INDI PRICE

~~£379.99~~

£279.99

INDI A600 ACCESSORY PACK

- * Microswitched Joystick * Lockable Disk Box * Disk Wallet * 10 Blank Disks * Kick Off 2 * Pipemania * Space Ace * Populous * Zapsac A600 Carry Case * Zappo T - Shirt.

INDI PRICE

~~WORTH £79.99~~

£26.99

TEL: 0543 419 999 FAX: 0543 418 079



AMIGA PERIPHERALS & ACCESSORIES

NEW FROM MICROBOTICS!!! M1230XA ACCELERATOR LAUNCH!!!

Microbotics beats the competition in price/ performance/ features and configurations. INDI is very pleased to announce the availability of the new 68030 accelerator product for the A1200: the microbotics M1230 XA (call it the "XA" for short). 50 Mhz as standard! Huge 128 MB memory design is standard (the biggest memory space in any A1200 peripheral) just look at these specifications and prices!

- M1230 XA W/40 MHZ EC 030 OMB **INDI PRICE £239.99**
- M1230 XA W/40 MHZ EC 030 4MB **INDI PRICE £369.99**
- M1230 XA W/40 MHZ EC 030 8MB **INDI PRICE £599.99**
- M1230 XA W/50 MHZ MMU 030 OMB **INDI PRICE £349.99**
- M1230 XA W/50 MHZ MMU 030 4MB **INDI PRICE £479.99**
- M1230 XA W/50 MHZ MMU 030 8MB **INDI PRICE 6711.99**



AUDIO VISUAL

MEGAMIX. Low cost, hi spec digital effects cartridge plugs into the printer port of the Amiga. Allows stereo sampling from almost any musical source.

INDI PRICE £29.99



TAKE 2. Animation package is a must for computer artists and enthusiasts of all ages. As used in Rolf Harris Cartoon Club.

INDI PRICE £37.99



VIDI AMIGA 12. The ultimate low cost colour digitiser for the Amiga. "The best value full colour digitiser on the market" AMIGA FORMAT.

INDI PRICE £75.99

ROMBO VIDI AMIGA 24(RT). For the more serious user, this 24 - bit version will again capture from any video source with true photo realistic images! A staggering 16.7 million colours can be utilised with incredible results. Full AGA chipset support.

INDI PRICE £239.99

AMIGA PERIPHERALS



2MB SMARTCARD. The original and still the only fully PCMCIA compatible memory card for A600/ A1200. Comes with lifetime guarantee. Beware of cheap imitations.

INDI PRICE £129.99

4MB SMARTCARD. Same as above but maximum 4MB.

INDI PRICE £199.99

ZAPPO 601
Trapdoor upgrade for the A600, 1Mb with RTC **INDI PRICE £49.99**
ZAPPO 601 INC As above only 512K, no clock **INDI PRICE £29.99**



MBX1200.

The original and best floating point unit and memory upgrade for the Amiga A1200. Available with 0,4 or 8 MB of 32 bit Fast RAM and a choice of floating point units. Now complete with real time clock (RTC)

- MBX1200Z 68881 14 MHZ 0MB **INDI PRICE £109.99**
- MBX1200Z 68881 14 MHZ 4MB **INDI PRICE £249.99**
- MBX1200Z 68881 14 MHZ 8MB **INDI PRICE £449.99**
- MBX1200Z 68882 25 MHZ 0MB **INDI PRICE £169.99**
- MBX1200Z 68882 25 MHZ 4MB **INDI PRICE £309.99**
- MBX1200Z 68882 25 MHZ 8MB **INDI PRICE £519.99**
- MBX1200Z 68882 50 MHZ 0 MB **INDI PRICE £249.14**
- MBX1200Z 68882 50 MHZ 4MB **INDI PRICE £379.14**
- MBX1200Z 68882 50 MHZ 8MB **INDI PRICE £579.99**
- 68882 FPU UPGRADE 50 MHZ **INDI PRICE £169.99**



ROCTEC ROCGEN PLUS.

As above but with extra features such as tinting and signal inversion. Allows for real time editing of graphics. Compatible with all Amigas.

INDI PRICE £129.99

ROCTEC ROCKEY.

The ultimate accessory for Amiga / Video fans. Separate RGB controls to chroma key on any colour.

INDI PRICE £249.99

ROMBO VIDI AMIGA 12 (RT). Based on the best selling Vidi Amiga 12. This all new version offers real time colour capture from any video source. Full AGA chipset support as standard for all A1200 / 4000 users.

INDI PRICE £139.99

DISK DRIVES



ZAPPO EXTERNAL FLOPPY

You've seen all the reviews on this popular and affordable second Amiga drive. Compatible with all Amigas.

INDI PRICE £59.99

Quality: 9 out of 10. Exceptional value for money.
AMIGA COMPUTING JAN 93



1084ST MONITOR.

Commodore's original and best selling colour stereo monitor. Now includes swivel and tilt stand for total ease of use.

INDI PRICE

£189.99

(£179.99 if purchased with A600 / A1200 / A1500)

OPAL VISION



NEW FOR OCTOBER RELEASE!

The already acclaimed Opalvision Board takes three further leaps into the future with the official launch of the Opalvision modules. With truly awesome capabilities the Amiga can now become the most professional 24 - bit video graphics power station ever!

The NEW OPAL VISION system(Rev.2)

The amazing Opalvision 24 - bit graphics board and software suite has been updated and is now even better value for money.

The software suite now includes:

Opal Paint V2.0 - Now includes full magic wand implementation and Alpha Channel that allows photo compositing with selectable levels on a pixel by pixel basis. The new Chrominance effect allows absolute, real time control of image contrast, brilliance and re - mapping of colours.

Opal AnimMATE V2.0 - offering real time play back of animations created by ray tracers, landscape generators, morphers and all other 24 - Bit software.

Opal Hotkey V2.0 - Display OpalVision graphics anytime with key combinations.

Opal Presents - Comprehensive, icon - driven presentation package
Imagine V2.0 Imagine 3D is the most popular 3D rendering software, that now supports OpalVision. This is a full version that would cost £300 if purchased separately.

"Quite simply, it's a spectacular product - Amiga Computing

"Undoubtedly the finest, most professional paint program to arrive on the Amiga" - Amiga Format

"Professional quality at this Price can't be turned away" - Amiga User International

"The verdict was unanimous - brilliant" - Amiga Shopper

INDI PRICE £599.99

PACK INCLUDES IMAGINE V2.0

MORPH PLUS

You've seen Micheal Jackson's video, you've seen the television adverts using the latest techniques in morphing, now now you can create the same results but at a fraction of the cost. Morph Plus is the latest and the ultimate in this technology. Whether you are a professional artist or just want to experiment at home Morph Plus is a must.

INDI PRICE £129.99



DELUXE PAINT IV AGA

Combines powerful tools with an intuitive interface so both professionals and beginners alike can get superb results quickly. New enhancements to the software include the ability to paint and animate in 4696 colours in the Amiga's HAM (Hold and Modify) mode. New animation features also include metamorphosis allowing you to change one image into another. You determine the number of frames and DPaint IV does the rest.

INDI PRICE £63.99

ART DEPARTMENT PROFESSIONAL

The ultimate in image processing providing many key benefits to Amiga users working with pictures. With ADPro you can read, write and convert between most common image file formats with unmatched flexibility. Full support for JPEG image makes it possible to maintain an image library in full 24 - bit colour without needing massive hard drive storage. Typically a 600 Kb image can be compressed down to 40 Kb!

INDI PRICE £139.99

REAL 3D V2

Is a full featured 3D animation, modelling and rendering program. With Real 3D V2 you can produce high quality images and animations of three dimensional models with an astounding level of realism. Imagine creating an animation that shows a handfull of balls bounce down a flight of stairs to the bottom. Gravity, collision, deflection and the elasticity of the balls are all automatically calculated by the program!



INDI PRICE £299.99

SCALA Multimedia 200 (MM200)

Is the ultimate on professional video titling. The eminent design of typefaces, the unlimited choice of typographical details, the high resolution and the more than 80 exciting wipes result in video captioning of exquisite quality. No wonder that Scala is used by leading television stations around the world.

INDI PRICE £399.99 also available

SCALA Pro V1.3

INDI PRICE £169.99

VIDEO DIRECTOR

With Video Director, anyone with an Amiga, a camcorder and a VCR can quickly and easily catalogue and edit the best moments from their video tapes. Video Director is extremely easy to use, you can actually control your camcorder and VCR from your Amiga screen. Video Director comes with everything you need to get started. The hardware to control your camcorder* and VCR is included

INDI PRICE £119.99

*Camcorder must have a LANC or Control L compatible port

Professional software is imported and sometimes subject to delay. Confirm delivery at time of order.

TERMS AVAILABLE OVER 6, 12, 24, & 36 MONTHS SUBJECT TO STATUS.

WHY NOT RING FOR A QUOTE. SAMEDAY RESPONSE. (SEE EXAMPLE)



Panasonic Quiet Colour Printing

We researched the colour printer market at great depth to find a colour printer good enough to cope with Amiga's powerful output, yet at an affordable price.

We found the perfect printer in the KX - P2180 and KX - P2123 quiet printers.

We then considered that if you were going to buy a Panasonic printer you would probably need a quality word processing package to use with it. We found that too, with 'Wordworth' yet at a retail price of £129.99 we thought that might be a little too expensive on top of your printer purchase! So together with Panasonic we decided to give a copy of 'Wordworth' free with every Panasonic printer. How's that for added value?

Panasonic KX - P2180



***WORDWORTH AGA COMPLETELY FREE!**
WITH PANASONIC QUIET PRINTERS. The writers choice. The ultimate word processor for AMIGA computers. Wordworth is undoubtedly the ultimate word / document processor for the full range of AMIGA computers. The graphical nature of WORDWORTH makes producing documents faster and easier, with the enhanced printing fonts (including full Panasonic KX - P2180 and KX - P2123 colour printing support), Collins spell checker and thesaurus, no other word processor comes close. "Without doubt this is one of the best document processors for the AMIGA, Today" (Amiga Format)
NORMAL RRP £129.99 inc. VAT

INDI PRICE

£169.99

The new Panasonic KX - P2180 9-pin quiet printer. Produces crisp clear text in mono or in 7 glorious colours with new quiet technology. The new KX - P2180 is typically 15dBa quieter in operation, than the competition.

- * **Fast Printing Speeds** 192 CPS NLQ
- * **Colour Printing** 7 colour palette (blue, red, green, yellow, violet, magenta, black)
- * **Quiet printing** Super quiet 45 - 48 dBa sound level (most matrix printers are typically in excess of 60 dBa)
- * **6 Resident Fonts** Over 6,100 type styles using Courier Prestige, Bold PS, Roman, Script and Sans Serif Fonts.
- * **3 Paper Paths** Paper handling from bottom, top and rear for total flexibility
- * **1 Year Warranty** for total peace of mind

Panasonic KX - P2123



INDI PRICE

£219.99

The new high performance Panasonic KX - P2123 24 pin. Quiet colour printer offers leading edge quiet printing technology at an affordable price

- * **Fast Printing Speeds** 192 CPS draft, 64 CPS LQ and 32 SLQ.
- * **Colour Printing** 7 colour palette (blue, red, green, yellow, violet, magenta, black)
- * **Quiet Printing** Super quiet 43.5 - 46 dBa sound level (most matrix printers are typically in excess of 60 dBa)
- * **7 Resident Fonts** Over 152,000 type styles using Super LQ, Courier Prestige, Bold PS, Roman, Script, and Sans Serif Fonts.
- * **24PIN Diamond Printhead** High performance and high quality output
- * **1 Year Warranty** for total peace of mind.

Panasonic LASER PRINTER

KX - P4410 LASER PRINTER



WORDWORTH AGA COMPLETELY FREE WITH PANASONIC LASER PRINTERS. The writers choice. The ultimate word processor for AMIGA computers
NORMAL RRP £129.99 inc VAT

KX - P4430 LASER PRINTER



Once again INDI have joined together with Panasonic to offer all Amiga owners the most outstanding Laser Printer offer ever. We are now able to offer high quality, professional laser printing at affordable prices. We are also giving away a copy of Wordworth with every Panasonic Laser Printer purchased (RRP £129.99). Whether you are looking for a laser printer to handle word processing, DTP, presentation or complex graphic applications - the Panasonic range offers you the power to meet your requirements.

KXP - 4410

- * 5 pages per minute
- * 28 resident fonts
- * Optional 2nd input bin (total printer capacity 2 x 200 sheets)
- * Low running costs
- * Parallel interface
- * Optional memory expansion to 4.5 Mb (0.5 as standard)
- * HP laserjet II Emulation

INDI PRICE

£549.99

inc. VAT

Imminent price increase. This price while stocks last.

WORDWORTH AGA COMPLETELY FREE WITH LASER PRINTERS



KXP - 4430

- * Satinprint (optimum resolution technology)*
- * 5 Pages per minute
- * HP Laserjet III Emulation, PCL 5
- * 8 Scalable fonts & 28 bitmap functions
- * Optional 2nd input bin (total printer capacity 2 x 200 sheets)
- * Optional memory expansion to 5.0 Mb (1 Mb as standard)

INDI PRICE

£699.99

inc. VAT

Imminent price increase. This price while stocks last.

*(Satinprinters use optimum resolution technology to produce truly outstanding print quality. This software technique smooths away traditional jagged edges on curved characters and lines by varying the printed dot size)

WORDWORTH AGA COMPLETELY FREE WITH LASER PRINTERS

Panasonic PRINTER ACCESSORIES



1) **PANASONIC AUTOMATIC SHEET FEEDER**
 Automatic sheet feeder for KXP 2180/ KXP 2123 holds 80 A4 sheets. **INDI PRICE £89.99**

2) **PRINT DUST COVER**
 Specially tailored quality dust cover for Panasonic KXP 2180/ KXP 2123 printer. **INDI PRICE £8.99**

3) **PRINTER STAND**
 2 piece printer stand. **INDI PRICE £9.99**

4) **PAPER PACK**
 500 sheets quality A4 paper. **INDI PRICE £9.99**

5) **CONTINUOUS PAPER**
 2000 sheets 1 part listing paper. **INDI PRICE £19.99**

6) **PARALLEL PRINTER CABLE**
 To be used when connecting Amiga to Panasonic printers. **INDI PRICE £8.99** (£5.99 if purchased with a printer)

7) **PANASONIC COLOUR RIBBON**
 Colour ribbon for KXP 2180/ KXP 2123. **INDI PRICE £18.99**

8) **PANASONIC BLACK RIBBON**
 Black ribbon for KXP 2180/ KXP 2123. **INDI PRICE £9.99**

SAVE ££££S ON THE FOLLOWING ACCESSORY PACKS

PACK 1 PANASONIC COLOUR RIBBON PACK
 Contains 6 colour ribbons for the KXP 2123 RRP £119.99. **INDI PRICE £89.99 SAVE £30!!!**

PACK 2 PANASONIC RIBBON PACK
 Contains 2 black and 4 colour ribbons for KXP 2180/ KXP 2123. RRP £99.99. **INDI PRICE £69.99 SAVE £30!!!**

PACK 3 PANASONIC DELUXE ACCESSORY PACK
 Contains automatic sheet feeder, 2 black ribbons, 2 colour ribbons, 1 dust cover, 2 piece printer stand. RRP £169.99 **INDI PRICE £139.99 SAVE £30**

Add £2.50 carriage to all printer accessories or combinations thereof

TEL: 0543 419 999

FAX: 0543 418 079

**LOW INTEREST CREDIT ON ALL ORDERS OVER £200
(PLEASE CALL FOR A QUOTATION, SUBJECT TO STATUS)**

AMIGA CDTV

THE MULTIMEDIA COMPUTER TOTAL HOME ENTERTAINMENT SYSTEM

PRICE CRASH!!!



BLACK 1048S MONITOR

At last the CDTV Monitor you have been waiting for. The original and best selling colour/ stereo monitor from Commodore is now available in black to complement your CDTV.

INDI PRICE £189.99

(£179.99 when purchased with CDTV Multi Media pack)

PACK CONTENTS AS STANDARD

- * Amiga CDTV Player
- * CDTV Keyboard
- * CDTV 1411 3.5" Disk Drive
- * CDTV Infra Red Remote Controller
- * CDTV Wired mouse
- * CDTV Welcome Disk
- * Manuals
- * Fred Fish CDTV Disk

AMIGA CDTV EXTERNAL HARD DISK DRIVE

You've got the CDTV, you've got the keyboard and the floppy disk drive - for a total computer solution all that's needed is an ultra fast hard disk drive. The CDTV - HD unit boasts a massive **60 Mb of hard disk storage** with lightning fast access times through its SCSI interface. The unit comes complete with Workbench 1.3 and all necessary cables.

INDI PRICE

INDI PRICE

PACK AS SHOWN £229.99

£219.99

If you are thinking of buying CDTV or already own one you'll be pleased to know that INDI stock all CDTV accessories and software that are available from manufacturers. We believe in CDTV and we therefore continue to support this exciting product. You will always have a source of product for your CDTV from INDI.

L to R

- CDTV Encore SCSI Controller + Internal Mount **£59.99**
- CDTV Internal Genlock **£99.99**
- Black 1084S Colour Stereo Monitor **£189.99**
- (When purchased with CDTV Multi - Media Pack) **£179.99**
- CDTV Remote Mouse **£39.99**
- Scart TV / Monitor Lead **£14.99**
- (inc Stereo Phono Lead)
- Megachip - 1Mb Upgrade Chip RAM Upgrade for CDTV **£152.99**
- CDTV Trackball **£69.99**

AMIGA CDTV SOFTWARE

ARTS AND LEISURE

- Advanced Military Systems **£29.99**
- Women in Motion **£29.99**
- Guinness Disc of Records **£34.99**
- Animals in Motion **£29.99**
- Connoisseur Fine Arts **£34.99**
- Fruits & Vegetables **£34.99**
- Trees & Shrubs **£34.99**
- Indoor Plants **£34.99**

EDUCATION

- Fun School - Under 5's **£24.99**
- A long Hard Day at the Ranch **£34.99**
- A Bun for Barney **£29.99**
- Cinderella **£39.99**
- Fun School for 5 to 7 **£24.99**
- Fun School for Over 7's **£24.99**
- Heather Hits her First Home Run **£34.99**

- LTV - English as a 2nd Language **£34.99**
- Mind Run **£29.99**
- Mud Puddle **£34.99**
- My Paint **£29.99**
- Paper Bag Princess **£34.99**
- Scary Poems for Rotten Kids **£39.99**
- Tale of Benjamin Bunny **£39.99**
- Tale of Peter Rabbit **£39.99**
- Thomas 's Snowsuit **£34.99**
- Moving Gives me Stomach Ache **£34.99**
- Barney Bear Goes Camping **£29.99**
- Asterix French for English I **£34.99**
- Japan World (PAL) **£34.99**
- Fractal Universe **£34.99**
- Read with Asterix **£19.99**

ENTERTAINMENT

- Battlechess **£39.99**
- All Dogs Go To Heaven: Electric Crayon **£34.99**

- Classic Board Games **£34.99**
- Dinosaurs for Hire **£14.99**
- Hounds of the Baskevelles **£29.99**
- Psycho Killer **£29.99**
- Sim City **£29.99**
- Trivial Pursuit (PAL) **£49.99**
- Wrath of the Demon **£29.99**
- Raffles **£34.99**
- Prehistorik **£34.99**
- Snoopy **£34.99**
- Town with No Name **£29.99**
- European Space Simulator **£34.99**
- Global Chaos **£29.99**
- Turrican II **£29.99**
- Guy Spy **£29.99**
- Curse of Ra **£24.99**
- Space Wars **£29.99**
- Defender of the Crown **£29.99**
- Case of the Cautious Condor **£34.99**
- Tiebrake Tennis **£19.99**

MUSIC

- Karaoke Hits I **£14.99**
- Music Maker **£34.99**
- Remix **£29.99**
- Voicemaster + Microphone **£39.99**
- Blues Brothers (Audio CD only) **£10.99**
- Music Colour **£39.99**

REFERENCE

- American Heritage Dictionary **£49.99**
- Complete Works of Shakespeare **£29.99**
- Illustrated Holy Bible **£29.99**
- New Basic Electronic Cookbook **£39.99**
- Timetable of Business **£39.99**
- Dr Wellman **£54.99**

AMIGA ACCESSORIES

PRICE CRASH!!!



AMIGA 1500

FEATURES INCLUDE:

- * 1Mb expandable using A2058 RAM board.
- * Includes 2 X 3.5" disk as standard with 5.25" Disk Bay.
- * Integral memory card and card expansion capabilities (most cost effective expansion route)
- * Workbench 2.00 and kickstart 2.04

CONTENTS:

- * Keyboard, mouse, reference manual, Puzznic, Toki, Elf (Games), D Paint III, Home Accounts, The Works (Platinum edition: Wordpro, Spreadsheet, Database) Joystick.

MONITOR AND PRINTER NOT INCLUDED

~~RRP £599.99~~

NOW £249.99

The AMIGA 3000 Workstation

The Amiga 3000 features the powerful Motorola 68030 processor running at 25Mhz (more powerful than the Amiga 4000/030) with the performance enhancing 68882 co - processor. An ideal video workstation for the OpalVision system.

FEATURES INCLUDE:

- * 68030 processor running at 25Mhz (featuring MMU)
- * 2Mb RAM (expandable to 18Mb on - board)
- * 52 Mb high speed SCSI hard Drive
- * 3.5" floppy drive
- * On - board flicker fixer
- * AT style keyboard
- * Mouse
- * Workbench 2.0 & Amiga Vision Multimedia software

DOES NOT INCLUDE THE MONITOR AND OPALVISION

~~RRP £1199.99~~

NOW £699.99

A2630 - 2Mb ACCELERATOR BOARD

The 1630 is a 68030 accelerator board running at 25Mhz complete with a 68882 FPU and 2Mb of 32 - Bit fast RAM suitable for the A2000. The 2630 board brings the performance of the Amiga 2000 upto nearly that of the A3000, ideal when running professional applications. An additional 2Mb of 32 - Bit fast RAM can be added to the 2630 board, giving a total of 4 Mb of fast RAM.

INDI PRICE £369.99

A2286 AT EMULATOR

The A2286 AT emulator kit offers IBM AT compatibility on the Amiga 2000 and 3000 systems, running at 10Mhz with 1Mb RAM and CGA graphics. The A2286 emulator also includes a 5.25" 1.2Mb floppy drive and MS DOS operating software.

INDI PRICE £159.99

A2088 XT EMULATOR KIT

The A2088 XT emulator kit offers IBM compatibility on the Amiga 2000 and 3000 systems, running at 4.77Mhz with 512Kb RAM and CGA graphics. The A2088 emulator also includes a 5.25" 360K floppy drive and MS DOS operating software.

INDI PRICE £79.99

A2058 RAM BOARD

An 8 Mb 16 - Bit RAM board, supplied with 2Mb RAM and upgradable in two steps. The 2058 is a zorro II compatible and they are compatible with the A2000.

INDI PRICE £99.99

A2300 GENLOCK

A cost effective home quality entry level internal genlock, suitable for the Amiga 2000/3000. The 2300 genlock is an ideal solution for anyone wishing to put titles or graphics onto home video.

INDI PRICE £39.99



A2091 CONTROLLER CARD

The 2091A is an autobooting SCSI controller card with the facility to mount the SCSI Hard Drive directly onto the controller card. The 2091A also has the facility to take upto 2Mb RAM (1/2 Mb steps). The A2091A controller is zorro II compatible and is therefore suitable for the Amiga 2000 although it does offer an ideal solution for the Amiga 4000/030, where leading edge performance is not require. The A2091A is still the most reliable Amiga SCSI card available and with the supplied software is the easiest way to install.

INDI PRICE £79.99



DESPATCH

All orders received by 6pm Monday to Friday are despatched sameday for delivery using our national courier - Securicor. (UK Mainland only). Saturday deliveries are available at a small surcharge. If you are out when we deliver, a card will be left at your home giving you a contact telephone number to arrange a convenient re - delivery.

Delivery queries can be resolved immediately using our on - line computer. Cheque orders are despatched immediately on cheque clearance, usually 10 working days from receipt. A delivery charge of £5.00 is made per item unless otherwise stated.

WE ALSO ACCEPT B.F.P.O. ORDERS (DUTY FREE) CARRIAGE CHARGE AT UK POSTAL RATES.

HOW TO ORDER

BY POST - Simply fill in the coupon below.
BY PHONE - phone lines open 9.00am - 7.00pm Mon - Fri. 9.00am - 4.30pm Sat. - where your call will be answered by one of our INDI sales team. After 7.00pm each day your call will be answered by answerphone. If you would like to place an order have all the details at hand including credit card. All offers subject to availability. Prices correct at time of going to press. May we suggest you call before ordering.

SEND YOUR ORDER TO:

**INDI DIRECT MAIL
1 RINGWAY INDUSTRIAL
ESTATE,
EASTERN AVENUE,
LICHFIELD
STAFFS. WS13 7SF**

AF1093

Please send.....
1).....
2).....
3).....
4).....

Price..... + Delivery.

I enclose cheque/ PO for £.....
or charge my Access/ Visa No.....

Expiry...../...../.....

Signature.....

Name.....

Address.....

Deliver to if different.....

Daytime Tel.....

Postcode.....

APOLOGIES ARE IN ORDER

It seems that last month's *AF* demo of *SkidMarks* did not run on Amigas with 512K fast + 512K chip RAM memory configuration. We apologise for this oversight in final testing. The official Acid Software beta tester has subsequently been fired. As *Amiga Format* are being so kind as to replace any disks that readers send in with versions that will work we felt an apology was in order from us (being the polite Kiwis that we are).

However, now that we've gone and paid for a full colour page advert we thought it would be a bit silly to use the whole page just to apologise when we could be plugging the game...



Title:	SkidMarks
Release Date:	22nd Nov. 1993
Publisher:	Acid Software
Number of Tracks:	Twelve
Offroad Vehicles:	Four
Customised Cars:	Yes
Modem Connect:	Yes
Maximum Players:	Four
Minimum Hardware:	1Mb Amiga
RRP:	£19.95

BETA TESTERS REQUIRED

Due to unforeseen circumstances, Acid Software have found themselves without beta testers for their upcoming release *SkidMarks*. Fast, dangerous drivers are required for rigorous testing and fine tuning of final release. Send £5 with your name, address and Amiga specs to our UK office and we will immediately send you our beta tester disks including the track and vehicles pictured as well as a detailed questionnaire. By returning the completed questionnaire before November 1 we can then make final adjustments to the game before its release. Of course we'll also give participating testers a 50% discount on any purchases of the final release package.

THE BOTTOM LINE IS PLAYABILITY. Offroad cars that handle like no others in computer game history and a comms link that will enable you to prove your skills all over town without leaving home.

THE GRAPHICS ARE AWESOME. 800 frames of Imagine ray-tracing for each vehicle combined with super smooth iso-scrolling tracks packed full of beautiful detail.

THE ACTION IS INTENSE. More horsepower and less traction than ever before combined with 3 opponents out to bend your fenders anyway they can.

Brought to you by Acid Software, dedicated to putting the Amiga back on top with just one word : **PLAYABILITY!**

ACID
SOFTWARE

PO Box 3172, Hampstead, London NW3

SCREENPLAY



A miner classic...

DIGGERS

In this issue...

First Impressions of new titles	p58
Diggers CD ³²	p62
Burning Rubber	p68
Space Hulk	p70
GearWorks	p74
Civilization A1200	p78
Whale's Voyage A1200	p78
1869 A1200/4000	p79
Morph A1200	p79
European Champ'nship Soccer	p80
UMS Complete Compilation	p86
Caesar Deluxe	p88
Micro Machines	p96
Pinball Fantasies CD ³²	p100
James Pond Robocod CD ³²	p101
Budgets	p104
F17 (new release!)	
Midwinter II Flames of Freedom	
Super Space Invaders	
Grand Prix Circuit	
Shadowlands	
Gamebusters	p107
(with tips for all the current top-sellers in Chartbusters, plus Flashback, Dune & more)	

And it's free, too! Check out the game that comes with CD³² on page 62

INTRODUCING OUR PANEL OF EXPERT GAME REVIEWERS...

MARCUS DYSON



"Take two bottles into the shower? Not me!"

I take a crate of Czech Bud and refuse to come out until Easter," claims The Boss. Sadly, we know this to be the truth, and it explains why he's hoping Commodore invent a waterproof portable.

ROB MEAD



A big AF welcome to new full-time games supremo

Rob, who used to be with our sister mag ST Format but is pretty chuffed to be moving to a real games-playing machine. Would he swap his new improved Amiga 1200 for two old Ataris? "Get stuffed!"

ANDY NUTTALL



Nutts has moved on to bigger things, but stays

with us for the odd game review. When we offered him a fizzy drink, he said "Hey! I want that! Now!" Sadly, when he said it he was looking at Rich's Claudia Schiffer pics, not a curvaceous Coke bottle.

RICHARD JONES



Now he's the proud dad of a baby girl,

Rich has been taking a profound interest in throwaway nappy ads. "It's absorbing," he tells us. Then he makes a telling comparison between Pampers and John Major: both are disposable and full of...

RICHARD BAGULEY



Bilbo is keen to know why that huge sausage

thrust its way on to the screen in the Levi's 'Bad about the boy' ad. "Are they trying to tell us something?" he asks. "Maybe they should combine it with the Flake ads and keep everyone happy..."

STEPHEN BRADLEY



Born and bred in the North-shire town of

Tadcaster, The Lad is one of the country's foremost experts on John Smith's beer adverts. "Believe it or not, there are still many tens of people in the UK who find flat caps and whippets amusing."

PRINTERS

COMPUTER WORLD ARE A **CITIZEN** SUPER DEALER

SWIFT 90 COLOUR - 9 PPM **£169.99**
 colour printer is fast quiet, has additional fonts and comes complete with a 2 year warranty and V.2.0 driver disk

Swift 90 Mono **£159.99**
 Swift 240 Colour (FREE Pen Pal 1.5) **£269.99**
 Swift 240 Mono **£259.99**
 Swift 200 Colour **£224.99**
 Swift 200 Mono **£192.99**
 Citizen Auto sheet feeder **£79.99**
Citizen printers come with 2 year warranty. • V.2.0 Amiga driver disk

BUBBLE-JET

MAJOR DEALER • MAJOR DEALER

Canon

CANON BJ 105X upgraded version of BJ 105, the worlds biggest selling portable inkjet printer. Newly designed front end, faster print times, more fonts, 95% Amiga Gold Award, inc. BJ 105X Driver Disk!

CANON BJ 200 95% Amiga Gold Award. • Min 80 page Auto sheet feeder. • Features include: 300 dpi. • Min 80 page Auto sheet feeder. • minimum 3 pages per minute sheet rates!

CANON BJ 230 **£379.99**
 Wide carriage version of BJ200

CANON BJ 300 **£429.99**
 80 column bubblejet provides laser quality output.

CANON BJ 330 136 column bubblejet. **£499.99**
 CANON BJ ex/sx cartridges. **£17.99**
 CANON BJ 200 cartridges. **£24.99**
 BJ 10 ex/sx Autosheet feeder. **£49.99**

HEWLETT PACKARD

H.P. Portable **£359.99**
 H.P. 510 Mono. **£262.99**
 Successor to the top selling 510 Mono

H.P. 500 (Colour). **£309.99**
 H.P. Deskjet 550 (Colour). **£519.99**
 4 times faster than previous HP range • Top sellers • Superior printers HP printers come with 3 year warranty.

H.P. Deskjet 1200C Laser/inkjet. **£1369.99**
 45 scalable fonts, P.C.L. level 5, 6 pages per min. 300x600 dpi (if using the resolution enhancement tech 4 pages per min.) 2Mb of RAM expandable to 28 Mb. laserjet compatible.

H.P. Laserjet 4L **£602.99**
 4 pages per minute, laser easy to install & use, no on/off switch 1 tray 100 input 50 output. 26 scalable typefaces, 1Mb of RAM expandable to 2Mb.

HP black ink cartridge **£24.99**
 HP colour ink cartridge **£29.99**
 • Official Double Life

PRINTERS

COMPUTER WORLD PRINTER PACK
 Supplied with ALL printers containing 1.8m std. printer cable, printer ribbons/cartridge and 250 sheets of paper absolutely FREE.

LC-100 Colour **£155.99**
 LC24-100 **£189.99**
 LC-20 **£132.99**
 LC-24-20 (II) **£224.99**
 LC-200 Colour **£199.99**
 LC24-200 Colour **£264.99**
 XB24-200 Colour **£379.99**
 SJ48 Bubblejet **£219.99**
 LS-5 Laser Dual Bin, 0.5 Mb. **£599.99**
 LS-5X Laser as above with 1Mb 600x300 dpi. **£669.99**
 LS-5TT Laser 2Mb **£899.99**

NEW NEW NEW

£514.99

A stunning new thermal printer from Star. Full 360 x 360 dpi, in both mono and colour. 3 ppm in mono, 1.4 ppm in colour. Can print up to 600cps. CPS Sheet feeder as standard, virtually portable printers, small footprint. Zenon made to offer easy printing in A4 and A8 sizes. NOW ON DEMO IN STORE. MUST BE SEEN TO BE BELIEVED!!!
 Star printers come with one year warranty.

STAR AUTO SHEET FEEDERS
 LC20 **£57.99** LC20-20 **£62.99**
 LC24-200 **£62.99** LC24-20 **£49.99**
 SJ48

PRINTER ACCESSORIES
 We have a large range of high quality printer accessories for all the printers we sell including: dust covers from **£2.99** ink cartridges from **£13.99** • Mono ribbons from **£3.50** • Colour ribbons from **£7.99** • Printer stands from **£7.99**

MOUSE & TRACKBALLS

Beetle Mouse Kids Mouse with support dpi **£14.99**
 Starts n Stripes Kids Mouse with support dpi **£14.99**
 European Community (Design) **£14.99**

ALL MAKE EXCELLENT KIDS PRESENTS!
 Mouse 121 **£14.99**
 Golden Image-Mega Mouse 90% AI Gold **£12.99**
 Mega Mouse 2 Newly designed, 400 dpi **£16.99**
 Optical Mouse, High precision pointing device **£29.99**
 Crystal Trackball **£37.99**
 Infrared-Cordless-Mouse **£47.99**
 (Rechargeable top selling innovation) **£39.99**
 Optical Pen Mouse **£3.99**
 High Quality 9mm mouse Mats **£3.99**
 Auto Mouse/Joystick Switch **£15.99**
 Don't damage your Amiga's ports! This device saves wear and tear makes switchover FAST.

SCANNERS

Powerful image processing tools for the office or the home environment.

POWER-Features include: 100-400 dpi • 64-Greyscale throughput to printer • Free Editing software.

Power Scanner v3.0 **£99.99**
 includes free upgraded editing software.

Power Scanner v3.0+OCR **£149.99**
 includes free upgraded editing software

Power Scanner v3.0 **£149.99**
 includes free upgraded editing software

Power Scanner Colour **£234.99**

GOLDEN IMAGE-
 Afascan Features: Size and Save • Miraph Jr. OCR software • 400 dpi • 256-Greyscale • Nit A1200/4000 compatible.

CW NEW LOW PRICE **£139.99**
 Afascan + Features: Touch up an image it • Miraph Jr. OCR software • 400 dpi • 256-Greyscale • 100% compatible with all Amigas.

CW PRICE **£169.99**

DISKS

Don't confuse these quality disks with others currently available. 3.5" 100% certified error free 70% clip. All disks include FREE high quality CW labels.

10	£4.99	200	£72.99
25	£12.99	500	£174.99
50	£22.99	750	£259.99
100	£39.99	1000	£339.99

Now back in stock! TRK branded 3.5" DS DD diskettes based on 10's with labels. Top quality media from the experts!

10	£5.99	100	£52.99
50	£28.99	500	£249.99

1000 Computer World Disk Labels. **£9.99**

ACCESSORIES

Premier Control Centre **£34.99**
 For the A500/A500 and A500+

CW Stereo Speakers **£37.99**

DATA SWITCHES (25 pin D type)
 2 way **£15.99** 3 way **£17.99** 4 way **£19.99**

Connecting Cable for the above **£9.99**
 Action replay cartridge for A500/500+ **£54.99**
 Hi-Fi Stereo Speakers (new style) **£39.99**
 Spectrum Emulator (on 2 disks with 8 games) **£2.99**
 Replacement internal A500/500+ drive **£49.99**
 Dust Cover A500/500+ **£5.99**
 Dust Cover A1200 **£5.99**
 Dust Cover A600 **£5.99**

By Post to:

PHOENIX COMPUTER WORLD, UNIT 2, YORK TOWERS, 383 YORK ROAD, LEEDS LS9 6TA.

Please make cheques payable to Phoenix. Allow 5 working days for cheque clearance.

*Same-Day Despatch on Credit Card Orders/ bankers draft/ building society cheque/Postal orders.

CUSTOMER CARE AND GENERAL ENQUIRIES
(0532)350652 FAX: (0532) 350702

MODEMS

U.S. ROBOTICS
 AUTHORISED RESELLER

The No 1 name in fax modems, US Robotics pride themselves on high quality modems at an affordable price. They come backed with a 5 year warranty and are fully BAST approved.

THE SPORTSTER **£269.99**
 Comes complete with optics 2 software and standard Amiga to Modem Cable. This modem incorporating data pump technology, operates at 14400 bps standard. It is 50% faster than 9600 bps modems and has full error control and data compression. It has the ability for throughput to reach 57600 bps.

WHY IS SPEED SO IMPORTANT?

THE FASTER YOU GO THE LESS IT COSTS!

384 MINS	£53.08
142 MINS	£26.54
13.07 MINS	9.3 MINS
2.56	£2.56
1.76	£1.76

2MB FILE TRANSFER
 Calculated at 50 pence per unit (peak rate long distance)

V2 **£26.54** V2S **£26.54**
 28800bps V.22bis 14.4Kbps
 Data Compression 10x Compression

V32 bis + fax **£383.99**
 As above with 5 year warranty, cable & software.

Courier HST 16.8 **£399.99**
 As above with 5 year warranty, cable & software.

Courier HST Dual 16.8 + Fax **£509.99**
 As above with 5 year warranty, cable & software.

LEADS & CABLES

Mid-Midi 2m **£3.99** Modulator ext **£9.99**
 Mid-Midi 3m **£4.99** Amiga-Scart **£9.99**
 Mid-Midi 5m **£5.99** Amiga-8033Midi **£9.99**
 Disk Drive ext. **£9.99** Joystick long ext. **£4.99**
 Mouse/Joystick ext **£4.99**
 Serial/Modem cables **£4.99**
 Amiga-Multisync **£9.99**
 Amiga-Microviter **£9.99**
 Amiga-CPC monitor **£9.99**
 Amiga-868/TV **£9.99**
 SCSI Cable various **£9.99**
 Printer 1.8m **£5.99** Printer 2.8m HQ **£7.99**

SOFTWARE

ACCOUNTING

Arena Accounts **£82.99**
 Personal Finance Manager Plus **£29.99**
 Home Accounts 2 **£39.99**
 System 3 **£39.99**
 System 3E **£54.99**
 Cashbook Comb **£54.99**
 Day by Day **£22.99**

SPREADSHEETS

Maxiplan V4 **£36.99**

PRESENTATION & SLIDESHOW

Can Do V2 **£99.99**
 Deluxe Video 3 **£99.99**
 Scala 500 **£19.99**
 Scala Professional **£119.99**

FRAGMENT & IMAGE PROCESSING

Make path for Vista **£2.99**
 Art Dept Pro Camy Kit **£134.99**
 Deluxe Paint 4 AGA **£4.99**
 Imagemaster **£129.99**
 Morph Plus **£149.99**
 Pro Vista v3 **£49.99**

INTEGRATED PACKAGES

Mini Office **£39.99**
 Gold Disk Office 2 **£46.99**

MULTI-MEDIA

Computer world are a major stockist of rombo's multi-media products for the Amiga and P.C. Be assured that we offer extensive technical backup on all Rombo products and that the majority are on demo in our showroom.

Vidi Amiga 12 RT (AGA suprt) **£135.99**
 Real-time colour capture from any video source

Vidi Amiga 24 RT (AGA suprt) **£224.99**
 24-bit full-time colour capture into any video source for the professional/serious user

Vidi Amiga 12 (AGA version) **£77.99**
 Vidi Amiga 12 (Std version) **£75.99**
 Rendable Genlock 8802 FMC **£169.99**
 CVP Genlock **£284.99**

HAMA Genlock 292 **£284.99**
 (10 Mhz bandwidth) Compatible with all Amigas. It has a composite video, S-video, RGB connector cable, RGB colour control for Amiga signal, output level control (video anti-jitter) Amiga 3000 switch.

Rocgen Plus **£139.99**
 Rocgen Chromakey **£129.99**
 Roctech PIP View (picture in picture unit) **£89.99**
 Rocgen VGA **£359.99**

SOFTWARE

LANGUAGES

Blitz Basic (Full UK Version) **£49.99**
 Amos **£21.99**
 Amos 3D **£35.99**
 Amos Professional Compiler **£35.99**
 Amos Professional Compiler **£35.99**
 Easy Amos **£29.99**
 Cygnus Ed Pro 2 **£54.99**
 Hisoft Basic **£22.99**
 Hisoft Extend **£169.99**
 Hisoft Dev Pac **£49.99**
 Hisoft Pascal **£69.99**
 Lattice C v6 + New Version **£239.99**

FONT PACKS

Anim Fonts (Vol 1, 2, 3 or 4) **£37.99**
 Kara Fnts (Hollines 1, 2, or 3, subhds) **£39.99**
 Videofnts: (Serif/SansSerif 1/2/Decorv) **£49.99**
 Typesmith **£12.99**

UTILITIES

Amiback **£42.99**
 Amiback Tool **£42.99**
 Cross Dos v5 (inc. PC emulator) **£49.99**
 GB Route Plus **£49.99**
 Directory Opus v4.0 **£49.99**
 Gigagem **£89.99**
 Hotlinks Editions **£89.99**
 Quarterback Tools Deluxe **£99.99**
 Quarterback v5 **£99.99**
 Quarterback Tools **£54.99**
 X-Copy Professional **£29.99**

VIDEO PRODUCTION & TITLING

Big Alternative Scroller **£36.99**
 Big Alternative Scroller 2 **£39.99**
 Broadcast Triler 2 **£26.99**
 Broadcast Triler 2 Hi-res Edition **£29.99**
 Font Pack 1 for BT2 **£169.99**
 Pro Video Post **£19.99**
 Scala 500 **£179.99**
 Scala Professional **£179.99**

ANIMATION

Deluxe Paint 4 AGA **£64.99**
 Morph Plus **£159.99**
 Cini Morph **£77.99**
 Real 3D Classic **£59.99**
 Real 3D V2 **£59.99**
 Fake 2 **£46.99**
 Personal Paint **£46.99**

RENDERING & RAYTRACING

Alternative 3D Textures **£29.99**
 Essence **£49.99**
 Prael 3D Pro **£144.99**

DATABASE

Mailshot Plus **£36.99**
 Superbase 2 **£19.99**
 Superbase Personal 4 **£119.99**

HOW TO FIND US

WELL WORTH A VISIT!

FREE PARKING

800 sq.ft. SHOWROOM

EASY ACCESS FROM M1 AND M62

Phoenix Computer World

Torre Rd. Bus Depot

Here Hills Lane

LEEDS City Centre

A64 York Road

Cross Gates

Seacroft

Mon. Sat. 9.30 am - 6.00 pm

Sun. 11.00 am - 3.00 pm

Thurs 'late till eight'

SOFTWARE

WORD PROCESSING & DTP

Pro-Page 2.1/Pro-Draw 1.2 bundle **£79.99**
 Final Copy Release 2.2 **£79.99**
 Kindwords **£79.99**
 Pagestream v2.2 **£79.99**
 Pagestream v3 Full UK version **£74.99**
 Pagestream Business Forms **£74.99**
 Pagesetter 3 **£74.99**
 Pen Pal **£69.99**
 Professional Page v4 **£69.99**
 SoftFaces (vols 1-4) **£69.99**
 Soft Clips **£69.99**
 The Publisher **£69.99**
 Turbo Print Professional **£34.99**

MUSIC & SOUND

KCS Level II v3.5 **£29.99**
 Bars and Pipes Pro V2 **£29.99**
 Kits for Bars and Pipes **£29.99**
 Super Jam v1.1 **£29.99**
 The Patchmeister **£29.99**
 Triple Play Plus **£29.99**
 SynPro **£29.99**
 One Stop Music shop **£29.99**
 AMAS 2 **£29.99**
 Clarity 16 (16 bit sampler) **£29.99**
 Quartet **£29.99**
 Stereo Master **£29.99**
 Videomaster **£29.99**
 Deluxe Music not v2.0 **£29.99**
 Megamix Master **£29.99**

GAMES-LEISURE

F-17 Challenge **£1.99**
 Soccer Kid **£24.99**
 Dune2 **£24.99**
 Walker **£24.99**
 Road Rash **£21.99**
 Gunship 2000 **£21.99**
 Swing Value **£21.99**
 Abandoned Places **£21.99**
 Graham Gooch Cricket **£21.99**
 F-19 Stealth Fighter **£21.99**
 Operation Stealth **£21.99**
 Tank Platoon **£21.99**
 Flashback **£28.99**
 Body Blows **£28.99**
 Superfrog **£28.99**
 Lemmings 2 **£27.99**
 Desert Strike **£27.99**
 Sensible Soccer **£27.99**
 Chuck Rock 2 **£27.99**
 Street fighter 2 **£27.99**
 B17 Flying fortress **£27.99**
 Zool **£27.99**
 Humans **£27.99**
 Abandoned Places **£27.99**
 Premier Manager **£27.99**
 Nick Faldo's Championship Golf **£27.99**
 Historyline 1914-1918 **£27.99**
 Sleepwalker-comic Relief **£27.99**
 Indy Jones & Fate of Atlantis **£27.99**
 Legends of Valour **£27.99**
 Wing Commander **£27.99**
 Sportsmasters (A1200 compatible) **£27.99**
 Wing Commander **£27.99**
 Syndicate **£27.99**
 The Last Viking **£27.99**
 The Ancient Art of War in the Skies **£27.99**
 Goal by Virgin New by dino Dimi **£27.99**
 Beavers Grandslam **£25.99**

SOFTWARE Blitz Basic (Full UK Version) **£49.99** Amos **£21.99** Amos 3D **£35.99** Amos Professional Compiler **£35.99** Amos Professional Compiler **£35.99** Easy Amos **£29.99** Cygnus Ed Pro 2 **£54.99** Hisoft Basic **£22.99** Hisoft Extend **£169.99** Hisoft Dev Pac **£49.99** Hisoft Pascal **£69.99** Lattice C v6 + New Version **£239.99** FONT PACKS Anim Fonts (Vol 1, 2, 3 or 4) **£37.99** Kara Fnts (Hollines 1, 2, or 3, subhds) **£39.99** Videofnts: (Serif/SansSerif 1/2/Decorv) **£49.99** Typesmith **£12.99** UTILITIES Amiback **£42.99** Amiback Tool **£42.99** Cross Dos v5 (inc. PC emulator) **£49.99** GB Route Plus **£49.99** Directory Opus v4.0 **£49.99** Gigagem **£89.99** Hotlinks Editions **£89.99** Quarterback Tools Deluxe **£99.99** Quarterback v5 **£99.99** Quarterback Tools **£54.99** X-Copy Professional **£29.99** VIDEO PRODUCTION & TITLING Big Alternative Scroller **£36.99** Big Alternative Scroller 2 **£39.99** Broadcast Triler 2 **£26.99** Broadcast Triler 2 Hi-res Edition **£29.99** Font Pack 1 for BT2 **£169.99** Pro Video Post **£19.99** Scala 500 **£179.99** Scala Professional **£179.99** ANIMATION Deluxe Paint 4 AGA **£64.99** Morph Plus **£159.99** Cini Morph **£77.99** Real 3D Classic **£59.99** Real 3D V2 **£59.99** Fake 2 **£46.99** Personal Paint **£46.99** RENDERING & RAYTRACING Alternative 3D Textures **£29.99** Essence **£49.99** Prael 3D Pro **£144.99** DATABASE Mailshot Plus **£36.99** Superbase 2 **£19.99** Superbase Personal 4 **£119.99**

Please note that when ordering any products in the current advert with a value in excess of £100 you are entitled to any game listed at a 10% discount... GREAT VALUE...only from COMPUTER WORLD!!

The future starts here and Rob Mead is the man to realise it for you. Join him as he negotiates the up 'n' coming games releases with greater dexterity and flair than Graham Taylor and David Owen combined...

REVOLUTION'S STEEL SKY

Lure of the Temptress programmers Revolution Software are set to wow us all over again with their latest graphic adventure, *Beneath A Steel Sky*.

Set for release by Virgin Interactive (081-960 2255) in November, *Beneath the Steel Skies* sucks you into what Revolution claim to be a highly realistic universe populated with murderous guards, a robot with a penchant for self-destruction and a mysterious figure called the Overman.

Revolution Software believe they've got a world-beating game on their hands thanks to a highly-developed game engine, a strong storyline and breathtaking visuals - conceived by DC Comics artist Dave Gibbons. There'll be a special 256-colour version for A1200 owners.

COMING AT

UP AND COMIN'

Keep abreast of the Amiga gaming scene with our indispensable guide to the forthcoming releases.

OCTOBER

Apocalypse	Virgin	Helicopter shoot-em-up
Blastar	Core Design	Weird Asteroids-style game
Cyberspace	Empire	Futuristic 3D racer
Frontier	Konami	Sequel to the classic space trader <i>Elite</i>
Jurrassic Park	Ocean	Monster game from a monster movie
Op Hellfire/Armour-Geddon 2	Psygnosis	Combative flight sim returns
Overdrive	Team 17	Bird's-eye racing game
Prime Mover	Psygnosis	Motorbike racing sim in 3D
Ryder's Cup Golf	Ocean	Timely golfing sim
Superheroes	Psygnosis	Comic book platform fun
F-117A	Microprose	Combat flight sim from the specialists
Alien Breed 2 AGA	Team 17	A1200 version of shoot-em-up sequel
Combat Air Patrol	Psygnosis	Combat flight sim
Creepers	Psygnosis	Cute and colourful platform game
Hired Guns	Psygnosis	Futuristic RPG with wicked multi-player option
Suburban Commando	Alternative	Arcade action with WWF star Hulk Hogan
Super League Manager	Ocean	Footy management sim
TFX AGA	Ocean	3D vector graphics shoot-em-up
Uridium 2	Renegade	Long-awaited sequel from Andrew Braybrook

NOVEMBER

Body Blows 2 AGA	Team 17	Beat-em-up action in 256 colours
Dennis	Ocean	Platformer based on popular cartoon series
Game 2 (Obitus 2)	Psygnosis	Germanic style shoot-em-up
Globule	Psygnosis	Platforms with <i>Putty/Morph/Blob</i> theme
Monopoly	Supervision	Classic board-game conversion
Mr Nutz	Ocean	Are they talking about our Andy?
Second Samurai	Psygnosis/Vivid Image	Superb sequel beat-em-up
Stardust	Bloodhouse	Brilliant Asteroids clone

DECEMBER

Akira	ICE	Manga style action game inspired by the film
Christmas Lemmings	Psygnosis	Lovable rodents return for a seasonal special
Cool Spot	Virgin	The 7-Up licence - Not!
Experiment	Ocean	Another in the new-look Ocean AGA series
No Mouth	Cyberdreams	Presumably, then, it's all trousers?



The UK's top rallying circuits are your destination and challenge in this new release, *Rally*.

RACEY VIRTUAL REALITY

Take control of the world's top rally cars in the latest Virtual Reality experience from Europress Software. A follow-up to *Lombard RAC Rally*, the new game puts you behind the wheel of porky-mobiles from Ford, Lancia and Subaru. You are then sent spinning around some of Britain's toughest rallying circuits. Based on the gruelling Network Q RAC event, *Rally* also features digitised video footage and Europress promise an unrivalled 3D racing experience.

Rally is released in November, price £29.99 with 256-colour versions for the A1200 and A4000. Keep an eye out for the definitive AF review. Europress Software: 0625 859333.



Fat Bloke has just taken a nasty blow to the 'nads from the geezer in the white crash helmet.



The guy in the helmet has just taken it big style from the girl in the cut-offs.

JAMES POND 3

The eagerly awaited sequel to *James Pond 2* finally arrives on the A1200 and CD³² in November.

James Pond 3 finds the fishy hero on a lunar mission to rescue two FISH agents who've been kidnapped by the evil Dr Maybe. The game features 112 frenzied levels filled with pantomime cows, fire-breathing chickens and tricky puzzle elements. Both A1200 and CD³² versions will include a new music soundtrack and digitised voice-overs. The A1200 version costs £29.99, but expect to pay another £5 for the game on CD. Millennium: 0223 844894.



James Pond turns a FISHy eye on Captain Kirk's job with his third excursion into the evil mind of Dr Maybe.

ELF MANIACS

New from Renegade for the pre-Christmas rush is *ElfMania*. This beat-em-up aims to avoid the brutality of traditional beat-em-ups like *Street Fighter 2* or *Body Blows*. As Ilari Kuittinen, of developers Terramarque, says: "We are trying to make this softer than other beat-em-ups. There is more fantasy, more jokes and little touches". But *ElfMania* will have a tough fight on its hands as it comes head-to-head with Virgin's *Mortal Kombat* this festive season. Ilari says: "Amiga buyers are very aware of what they are buying, they will appreciate our technical excellence." Renegade: 071-481 9214.



One of the storyboards for *Beneath the Steel Sky*, Revolution Software's follow up to *Lure of the Temptress*.



Inside the steel sky the scene looks more like a set from *Aliens*, with a maze of stairs and air-conditioning ducts for you to find your way through.



If you fancy a breath of fresh air up in steel sky land, things get a bit tricky - you'll be OK, just don't look down!



If you find your way to the control room, then you're on your way to winning. But don't get too cocky - there's plenty of fighting to be done yet.

TRACTIONS

UNDERWATER ACTION



Battles and building empires of an underwater kind are the main scenes in Thalamus' latest game, *Strategic Underwater Battles (SUB)*.

Thalamus have got plenty of nautical action lined up for you this month with the release of *SUB (Strategic Underwater Battles)*.

Peoplekind has constructed elaborate cities on the sea-bed after an apocalyptic conflict. It is now dependent on mining and the whims of ruthless sea pirates for its survival. You have to build a successful trading empire which can help sustain Peoplekind's precarious existence and ensure it survives the imminent arrival of a second, and this time potentially fatal, cataclysm.

Pitched sea-battles, underwater exploration and cut-throat deals with unscrupulous rivals are yours in *SUB*, available at the end of October, price £29.99. Phone Kompart: 0727 868005.

ALIENS INVADE WARWICKSHIRE



Codemasters' latest cutesy hero takes on an even cuter dragon in *Cosmic Spacehead*, available for the Amiga in November.

Codemasters will be hoping to turn their rivals Martian green with envy this Autumn with the release of *Cosmic Spacehead* on our fave games machine.

Cosmic is the cutesy hero of Codemasters' latest arcade adventure which follows the little guy's problematic voyage to Earth. No-one on his home planet Linoleum believed he'd

visited our planet, so he has to go back and collect some kind of memento to show his disbelieving pals. Problem is he's got no spaceship and only one Linodollar to his name.

The action takes place across four different locations - Linoleum, Detroitica, a Space Station and Earth itself - linked by 32 sub-games which *Cosmic* has to complete.

Cosmic Spacehead is set for release in November priced £25.99 and features all the cartoony graphics and lovable characters you expect from chaps behind *Dizzy's* platforming adventures. Codemasters: 0926 814132.



If you think *EastEnders* is full of miserable characters, wait 'til you meet with Jack the Ripper in Mirage's latest adventure.

JACK THE RIPPER RIDES AGAIN

Programmer Ezra Sidran is probably most famous for his *Universal Military Simulator* series, but he has recently turned to the story of London's most famous serial killer for inspiration.

Jack the Ripper is a graphic adventure set in the dingy back-alleys of Victorian London where a spate of violent and grisly murders has taken place. As one of Scotland Yard's finest, it's your job to piece together often contradictory pieces of evidence and track down the killer before he strikes again.

Jack the Ripper is released by Mirage (0260 299909) in October, price £39.99. There are no plans as yet for a separate A1200 version.

LORRY LOAD OF TROUBLE

Core Design are unloading their latest cartoon-style hero on the Amiga in November with the release of *Bubba 'n' Stix*.

Bubba is a floppy-haired, baseball cap-wearing truck driver who's been kidnapped by a bunch of alien reprobates. Things go from bad to worse when Bubba is accidentally dumped on a hostile planet awaiting the aliens' return. Enter Stix, a living, breathing piece of wood (oh this is getting silly now!) who befriends Bubba and helps him out of all kinds of perilous situations.

Bubba 'n' Stix is a 2D platformer featuring six horizontally-scrolling levels, cartoony graphics and visual gags galore. The game's released in November, price £25.99. Core Design: 0332 297797.



A bunch of angry-looking shrubs get their comeuppance in *Bubba 'n' Stix*, the latest platforming sensation from Core Design.

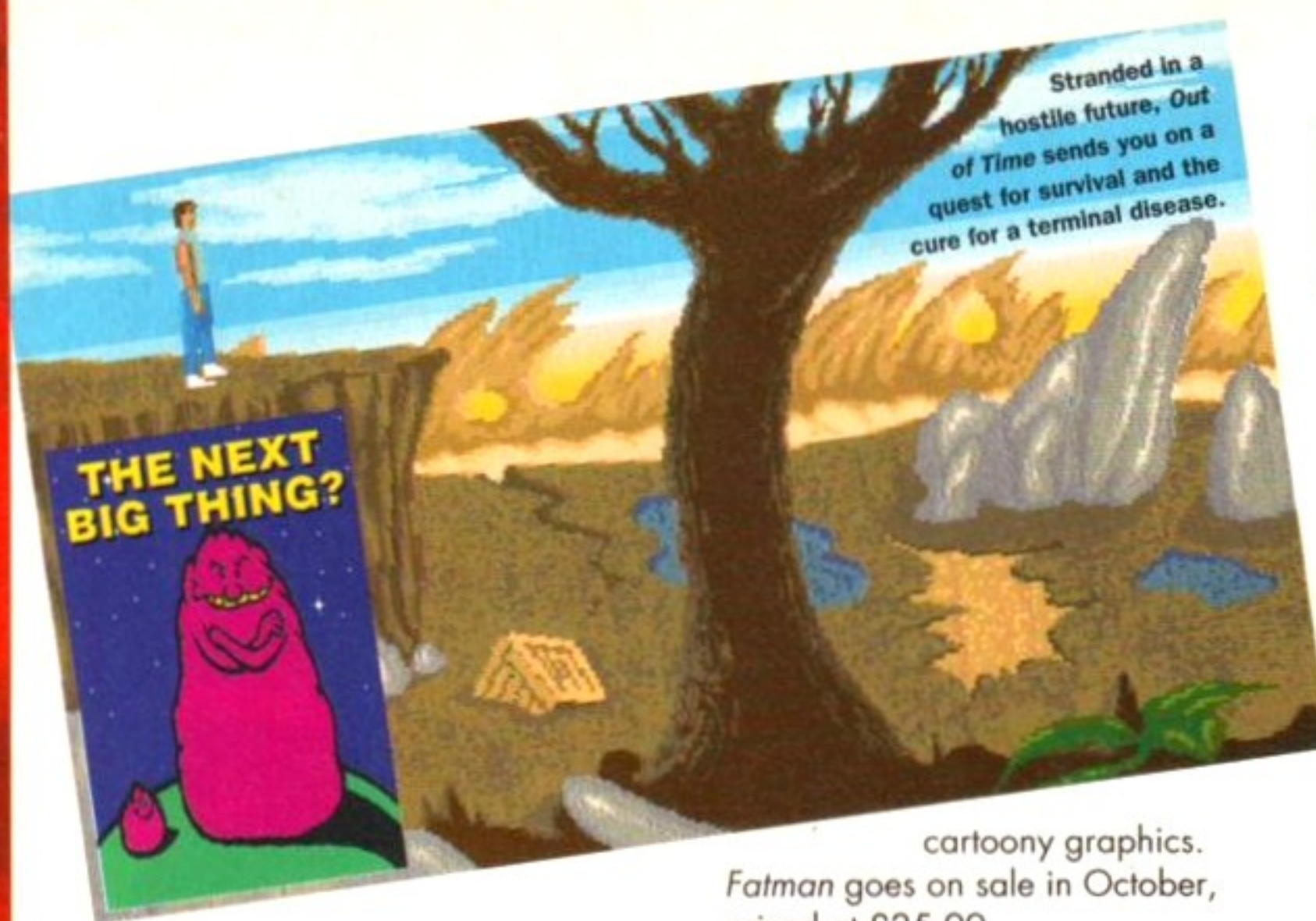

LIVING LEGEND

Pan-European software development house Black Legend have a heap of titles coming up, programmed as far afield as Poland...

Black Legend are currently working on no less than six new games for release on the Amiga over the next few months.

Fatman: the Caped Consumer is a seven-level platformer starring a rotund superhero who has to rescue his family from the lunatic grasp of Ted Thinsin, a mad scientist who's discovered a way of banishing fat people from the face of the Earth. The game features all the usual platform shenanigans like end-of-level meanies, power-ups and humorous

cartoony graphics. *Fatman* goes on sale in October, priced at £25.99.

Gunslingers, meanwhile, is a two-player shoot-em-up set in the American Wild West. You and a pal can play Sheriff and Deputy or, more excitingly, the Outlaw whose posse is arriving to shoot up the town. The action's viewed from a bird's-eye perspective and there are six different game types - including one against all - as well as numerous strategy elements. *Gunslingers* is due for release early in 1994, price yet to be confirmed.

There's more shoot-em-up action in *Fear*, an action adventure game

set on a space cruiser which has been taken over by a gang of particularly nasty aliens. It's your job to make your way through the ship's labyrinthine corridors, disarm its defence systems and recapture it. The game's still in the early stages of development, but it should be released early next year for the A500 and A600.

Continuing the futuristic theme is *Out of Time*, the tale of a scientist who puts himself into hibernation after contracting an incurable disease. He wakes centuries later to discover the world has become an even more hostile and dangerous place, and still a cure eludes him. The game combines adventure, platform and shoot-em-up elements and should be released sometime in the new year.

Outsiders is a 3D vector graphic adventure that pits a bunch of astronauts against a megalomaniac supercomputer called Brain. Before you can pull the plug on the evil machine there are 700 rooms for you to explore filled with robot sentries and puzzle elements for you to solve. *Outsiders* has a provisional release date of November, priced at a reasonable £25.99.

With all this gloom and doom around, it's about time you cuddled up with the cutesy hero of *Fantabulous*, a 25-level platform game, also available next month. The levels are split up into five themed worlds packed with baddies, secret rooms and bonus objects. Unusually, the five levels within each world are chosen from a pool of 10, so the game's unlikely to play the same way twice.

Rob Mead

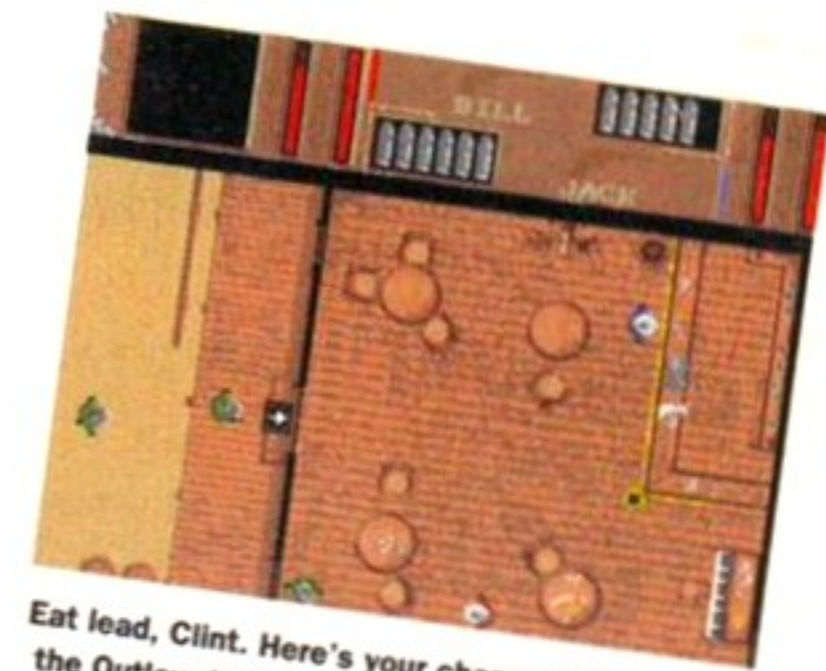

Eat lead, Clint. Here's your chance to take on the Outlaw Josie Wales in *Gunslingers*, a Wild West shoot-em-up.



Guide a team of space soldiers through a maze of extra-terrestrial infestation in *Fear*, an *Aliens*-style action adventure.



Vision Software are promising a trip from one end of hell to the other with their frantic new helicopter shoot-em-up. Look out for more details next month.



Cartoon characters don't come a lot dopier than Huckleberry Hound, the doggy star of another kiddie platform game from Alternative Software 0977 797777.



Batman Returns is a five-level action/adventure based on the movie of the same name. Released in November, price £24.99, the game is available from Gametek 0753 533445.

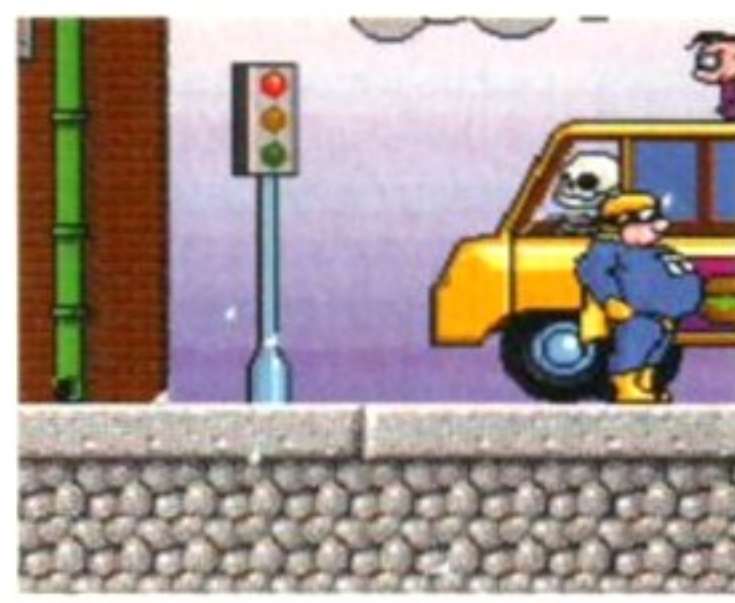

His belly's bigger than the dome on St Paul's Cathedral: *Fatman* is a bouncy new character.



This early alien-free screenshot from *Outsiders* shows just one of the hundreds of installations you have to explore.

Best-Selling Amiga Titles at Amazing Prices.

KindWords3
WORDPROCESSOR

An essential requirement for the office and your home! The friendliest word processor you'll ever use. Simple enough to have you working in minutes and yet sophisticated enough to provide all the features you need for your resumés, reports, correspondence and all your writing projects. Page layout, mailing list merge and a variety of other up-to-date functions make KindWords the right choice for users of all ages.

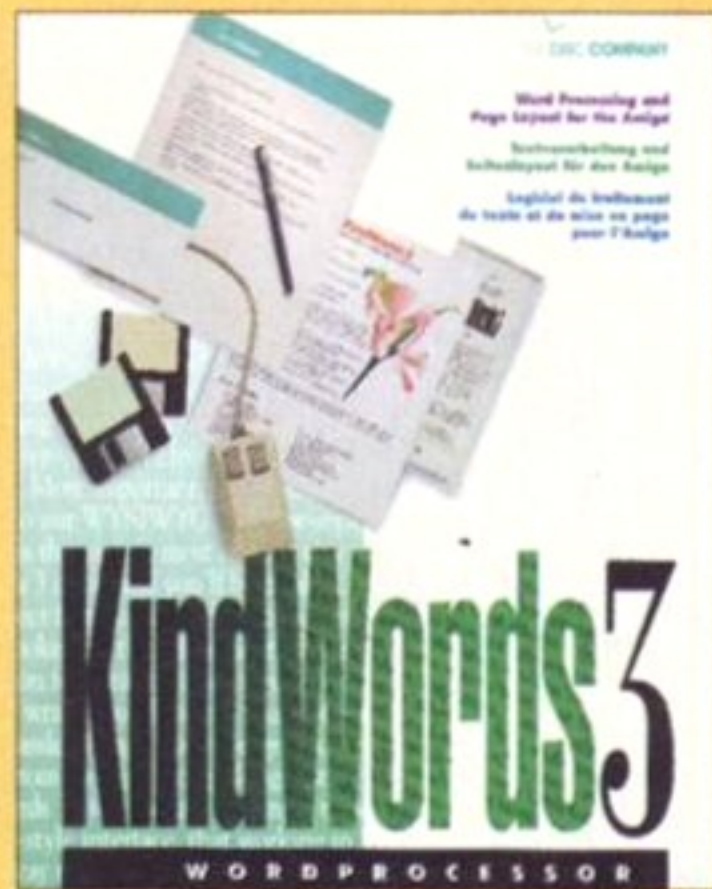

This tremendously powerful desktop publishing program offers unrivaled output, ultra-fast operation and a wide variety of superb special effects you

THE Publisher
PAGE LAYOUT

never imagined using. This publishing system lets you design and create professional-looking documentation efficiently and effortlessly. Now you can create the perfect page layouts for your leaflets, ads, newsletters or novels, with infinite ease!

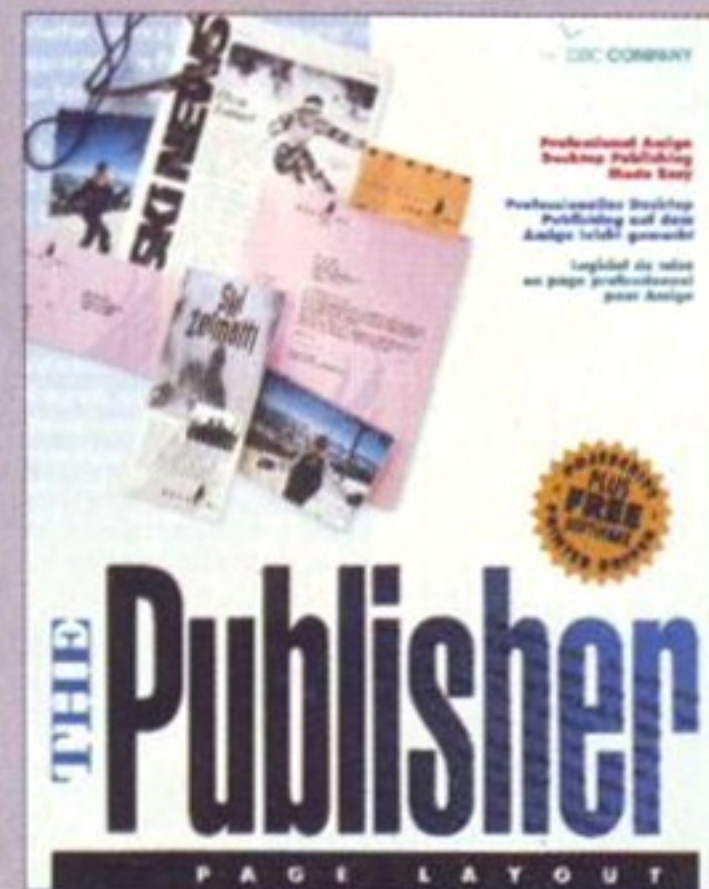

The Lost
TREASURES
of Infocom

Round out your computer game library with a fortune of interactive mystery, fantasy and science fiction adventures you'll be sure to treasure in one value-packed collector's edition! Enjoy spine-tingling suspense and brain-teasing puzzles in such big-name games as *Zork*, *Planetfall* and *Deadline*. Dare to solve murder cases, discover lost pyramids, break mysterious curses, and rendezvous with alien vessels in your favorite Infocom adventures!



MaxiPlan4

This acclaimed spreadsheet, database and charting program lets you take control of all your number and data tasks! Tackle financial analysis, database lists and marketing research with the accuracy and speed your projects require. Organize, calculate and present your data clearly and graphically with colorful charts all in one multi-use program. Save time and energy by automating repetitive or tedious tasks with our simple macros command and more!

Now you can get four of the all-time best-selling Amiga programs for amazingly lower prices.

For more information please call (0295 252524)

KindWords 3
NOW ONLY £29⁹⁹

The Publisher
NOW ONLY £29⁹⁹

The Lost
TREASURES of Infocom
NOW ONLY £29⁹⁹

MaxiPlan 4
NOW ONLY £29⁹⁹

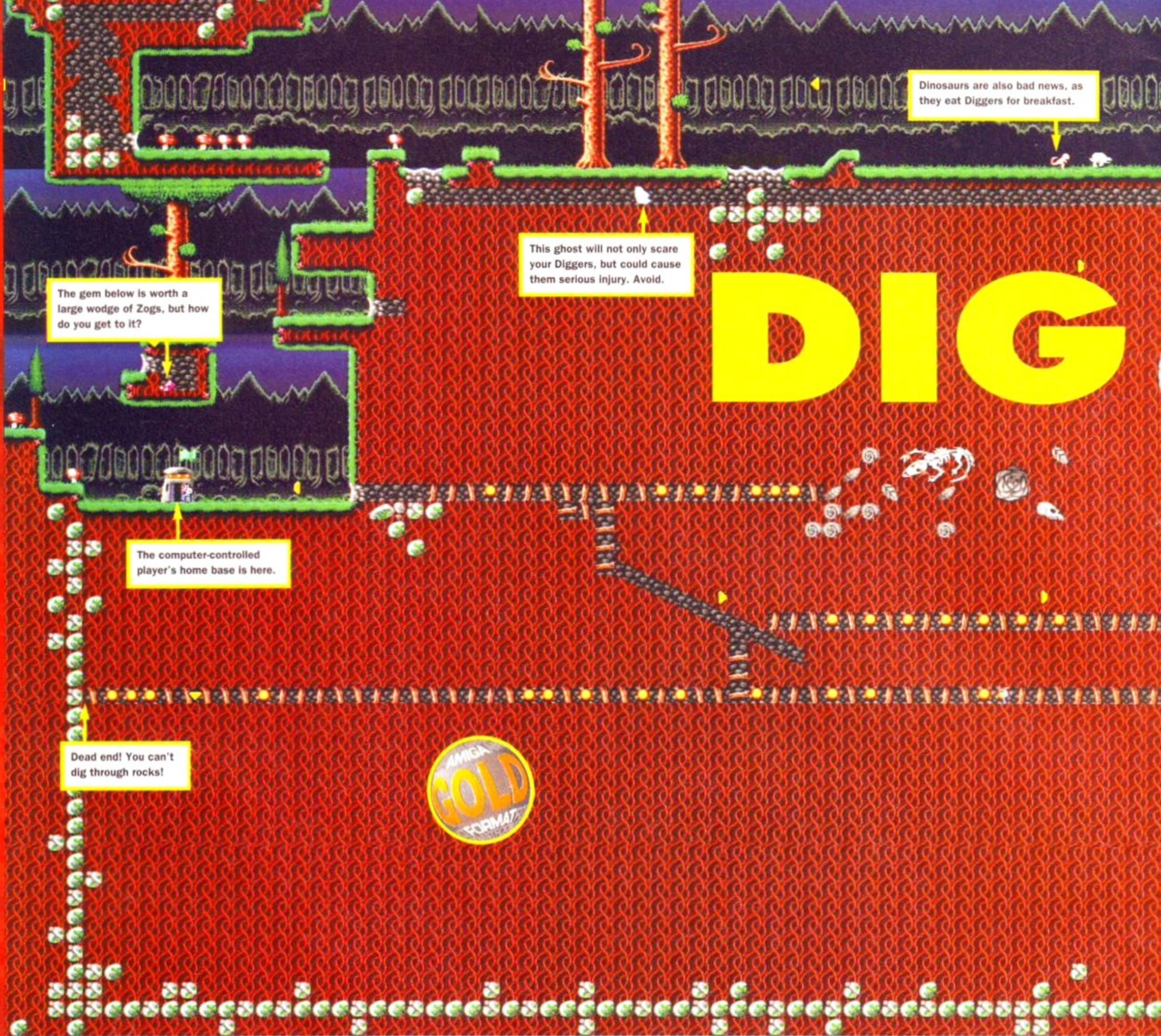

The gem below is worth a large wedge of Zogs, but how do you get to it?

This ghost will not only scare your Diggers, but could cause them serious injury. Avoid.

Dinosaurs are also bad news, as they eat Diggers for breakfast.

The computer-controlled player's home base is here.

Dead end! You can't dig through rocks!



DIG

Things are tough all over. What with the galactic recession, the stock market crash and the bottom falling out of the boiled stroat market, many desperate people are looking to make a quick buck. One of the planets which attracts the lost and the hopeless is Zarg, where the promise of untold riches hidden beneath the ground lures many a potential coal board executive.

Of course, you aren't stupid enough to actually do the nasty business of mining yourself, since there are four races of Digger waiting to climb down a dark and dingy hole at your command. You, as the controller, stay safely above ground controlling your Diggers. You can order them to carry out a number of actions, but don't be surprised if they decide that they can't be bothered to

follow your orders, and wander off or fall asleep instead.

The game is divided into more than 30 zones, and you have to work your way through these. In each zone, it's a race between you and a computer-controlled player to get a certain sum of money in the bank, which you get by digging up jewels and selling them at the bank. You don't necessarily have to do all the hard work yourself, though: you could nip into the computer player's mines and nick his gems when his Diggers' backs are turned.

Once you've got the required amount of dosh (the local currency is Zogs), you can move on to the next zone. Fail, and you have to start again from scratch. The eventual aim of the game is to get 16,500 Zogs, at which point you can retire and walk off into the sunset.



What a bunch of bankers. This is where you sell all your hard-earned (or purloined) gems for money. The windows above the booths show what type of gem is currently getting the highest price.

The game can be controlled either with the CD³² controller or by a mouse, which can be plugged straight into the second controller

port on the CD³² unit. Using the controller, you cycle through the five Diggers with the green button, while the blue button brings up a menu.

GERS

Come with us to the dark dank depths of the planet Zarg, where bold and hardy adventurers dig perilously deep into the depths in search of treasure. Richard Baguley gives you the full dirt on the very first CD³² game.

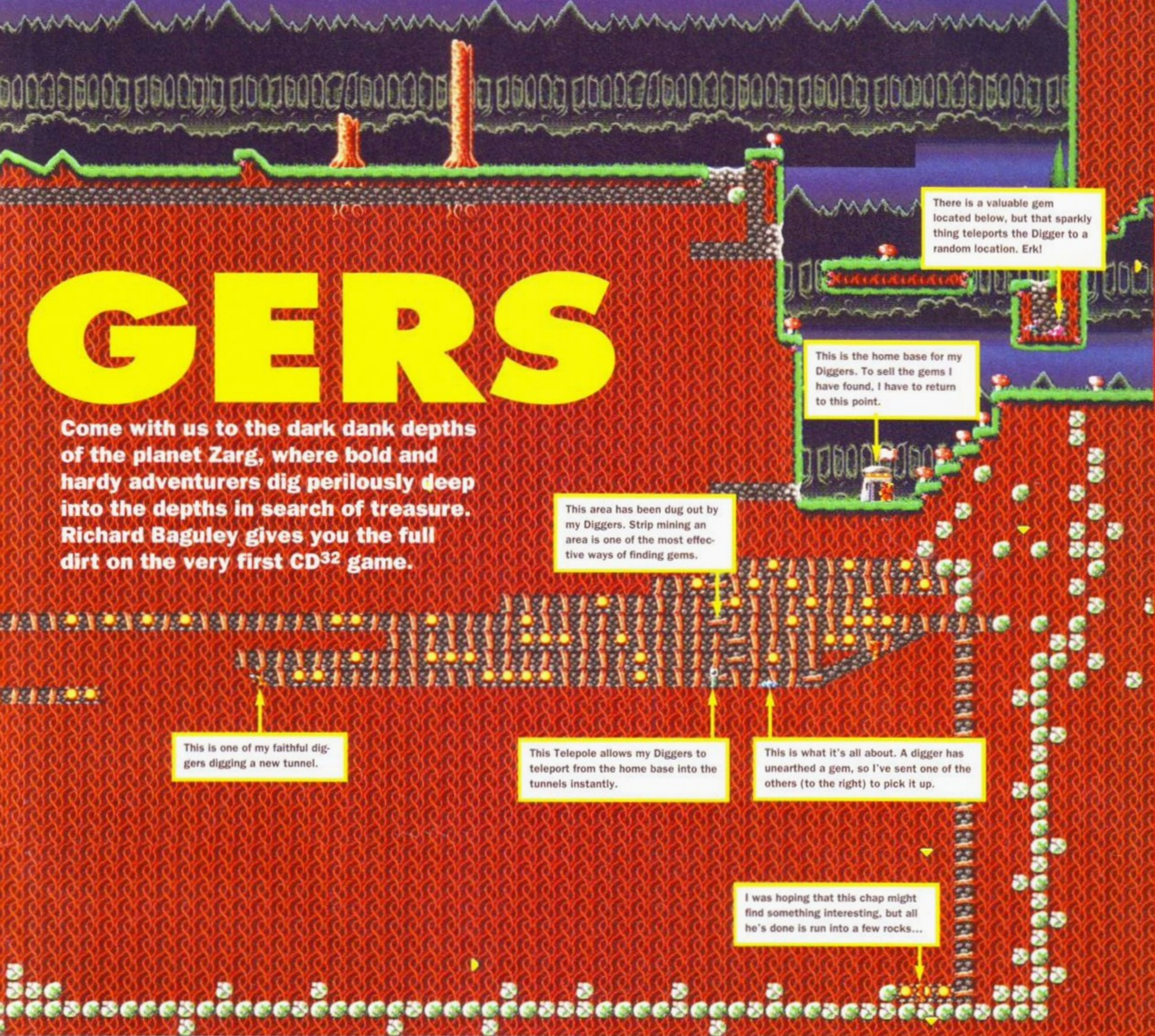

There is a valuable gem located below, but that sparkly thing teleports the Digger to a random location. Erk!

This is the home base for my Diggers. To sell the gems I have found, I have to return to this point.

This area has been dug out by my Diggers. Strip mining an area is one of the most effective ways of finding gems.

This is one of my faithful diggers digging a new tunnel.

This Telepole allows my Diggers to teleport from the home base into the tunnels instantly.

This is what it's all about. A digger has unearthed a gem, so I've sent one of the others (to the right) to pick it up.

I was hoping that this chap might find something interesting, but all he's done is run into a few rocks...



This cheerful-looking chap is the Zarg digging control thing. From this screen you decide what race of Diggers to use and which zone to dig in. You can also save games and access the on-line help.

From, this you can select various actions such as dig, walk, stand still, pick up or drop items, teleport and collect jewels with the red button.

Several of these bring up further sub-menus which control aspects such as which direction to dig in or what to drop or pick up. It sounds fairly

complex, and it is. The first few levels involve quite a lot of fiddling to get the option you want, but once you get the hang of it, it's a surprisingly good control method.

The mouse is easier to use to begin with, but it's worth persevering with the controller because the extra buttons do give you more control. For instance, if you want to stop a Digger who is about to plunge into a chasm, just cycle through the Diggers with the green button and then press the yellow one to stop your Digger in his or her tracks. It's a lot faster than using the mouse, but hardened mouse fans may want to stick with what they know.

Things are made even more complex by the fact that you can only see what's immediately around a digger, and you only see the entire map if you win the zone.

All the way to the bank

There are various different themes for the zones, including mountain, ocean, jungle and arctic. The scenery determines what sort of obstacles you are likely to come across. For instance, the mountain levels are filled with steep cliffs and deep chasms which have to be navigated, while the ocean levels are filled with weak points where you could accidentally flood your tunnels.

There are also numerous puzzles involving caverns deep in the bowels of Zarg filled with ghosts, aliens and other nasties. The reward for getting through these takes the form of special jewels which can be sold for much more than the usual price.

To solve these puzzles, you have to use some of the tools which you can purchase through the game,

Continued overleaf

THE OBSERVER'S GUIDE TO DIGGERS

The authorities on Zarg have decided that only four races of Diggers will be allowed on the planet. You are free to choose which you want to use, but each has its own strengths and weaknesses...



You can choose from four races of Diggers - from left to right a Grablin, Habbish, F'targ and Quarrior.

GRABLINS - They would be the perfect digging race, if it wasn't for their drinking problem. Their aim is to amass enough cash to build their own brewery, for their favourite tippie, Grok, which has been described as "smelling worse than the breath of a fire breathing Scaborasoaur from the swirling slime pools of Sulphuria". Due to its distinctive odour, Grablins need to buy a deserted planet to build this brewery on. Leave them alone for too long and they will all gather together to drink Grok and sing rugby songs.

HABBISH - A mystical race, who permanently hide their faces from view. Fast diggers, they have high endurance and the ability to use other race's teleport poles. However, leave them alone too long and they will join together to chant to their spiritual master, the lord high Habbish, who demands that to honour his spiritual awareness they build him a residence with walls covered in gems and hot and cold running champagne.

FTARGS - These delicate-looking beings are resilient and have plenty of endurance. They also have the advantage of healing twice as quickly as any other race after an injury, such as a fall or fight. They are curious, and get bored easily, often wandering off at the most awkward moments. Their aim is to amass enough cash to build the museum of metal marvels, which will house their historic scrap objects.

QUARRIORS - A hardy breed, who are extremely strong, but frankly rather thick. They're good in a punch-up, but can't dig for too long without getting exhausted. They have only recently moved from open cast mining into digging, so they lack imagination. Their aim is to amass enough funds to build a fortified encampment where they can practice digging and beating each other up in peace.



This is the shop, where you can avail yourself of all the latest advances in mining technology. Everything from automatic digging machines to dynamite via inflatable boats can be purchased.

such as Telepoles (used to teleport your Diggers around the map), lifts (for moving up and down deep caverns) and dynamite (used for blasting through walls too hard to be dug through). Not only can you get around the puzzles and gain access to different parts of the map with these, but you can also disrupt the computer-controlled Diggers by doing such nasty things as blowing up their tunnels, flooding them or releasing ghosts into them.

While you're working on the nasty business of digging into the depths or releasing evil aliens into your opponent's mines, a rather nice

soundtrack plays in the background. This is played direct from the CD, and there's also a nice intro track and another tune that's played while you're selling your gems in the bank.

Dumb Diggers

It's very easy to get confused about where the various Diggers are, and easy to forget what the Diggers are doing, because you never have a complete overview of the playing area. All you see is a single screen

around each of the Diggers as you cycle through them. Combine this with the fact that the Diggers are completely stupid, and will quite happily walk into water and drown or stroll nonchalantly into the arms of an oncoming nasty, and you've got a real challenge on your hands. Fortunately, the on-line help gives you full details of the Diggers' irritating little habits, and what sort of nasty beasts you're likely to come across in the tunnels.

Diggers certainly has an addictive edge, and the different levels give enough variety to make it worth coming back for more. It's not a game that you can leap straight into, since learning how to control the

Diggers and how to use the tools you can buy in the shop will take several zones and many days. Once you've learnt

your way around, though, the possibilities for fun are almost endless.

Given that playing through a zone can take several hours, it's annoying that you can't save your position halfway through a game. That apart, if you're prepared to put in the effort, there's treasure waiting to be plucked from the virgin soil...

Richard Baguley

"Diggers are very stupid and will happily walk into water and drown"

DIGGERS

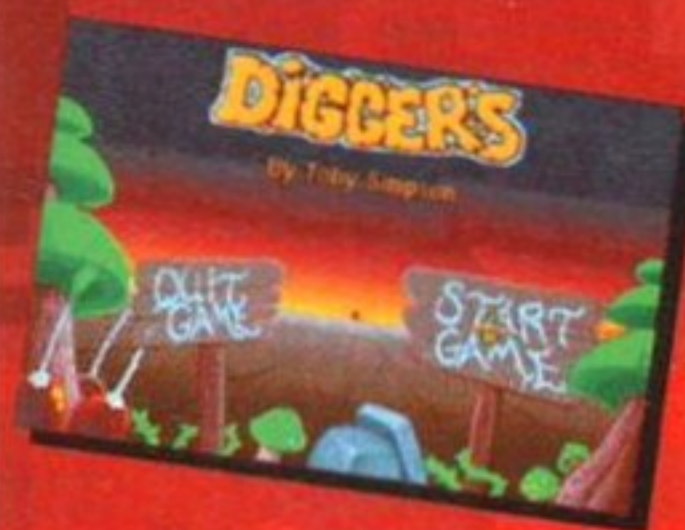

PROGRAMMER
Toby Simpson

PUBLISHER
Millennium (0223 844894)

PRICE
Free with CD³² machine

RELEASE
Out now - the first on CD³²!



GRAPHICS

Detail is hard to see on a TV.

SOUND

Excellent CD hi-fi soundtracks.

ADDICTION

Plenty of levels, big challenge.

PLAYABILITY

Control takes getting used to.

VERDICT

"An extremely addictive game once you've learnt the control system and got the hang of the gameplay, but it's no pushover and does take some time to get into."

93%

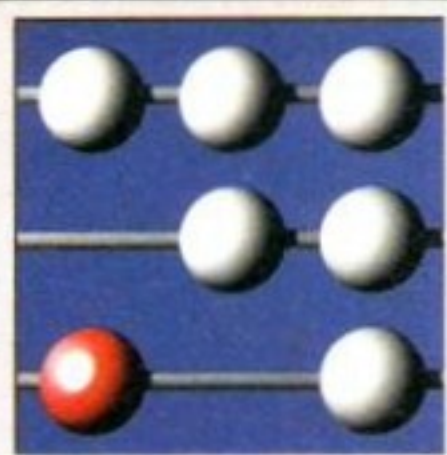

CALCULUS

COMPUTER STORES

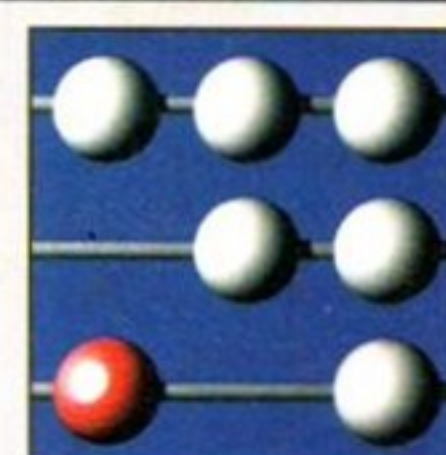

"THE NEW GENERATION"

Amiga CD 32

32-bit 14mhz 2Mb RAM, Full Motion Video Expandable



It's just not possible to capture the superb quality of the new Amiga CD32 from an advertisement fortunately there's a Calculus Store close to you. So why not call in and ask for a demonstration and experience tomorrows technology today.

SPECIFICATIONS:

- * 14 MHZ 68EC020 processor
- * 2 Megs 32-bit chip RAM
- * 2 Joystick ports/controller ports
- * S-video jack
- * Composite video jack
- * RF output Jack
- * Stereo audio jacks
- * Keyboard connector/ auxiliary connector
- * Full expansion bus
- * Headphone jack
- * Headphone volume control
- * External brick power supply
- * Internal MPEG FMV expansion capability
- * Multiple session disc capability

£289.99

2 FREE GREAT CD GAMES, OSCAR AGA AND DIGGERS AGA

NEW PACK



DESKTOP DYNAMITE

The power of the Amiga 1200 is unleashed with this great new pack. Specially re written software takes full advantage of the 1200 AA Chipsets graphic capability.

- * Wordworth AGA and Print Manager. There is no better word processing package for the Amiga
- * Dennis The Menace AGA
- * Oscar AGA
- * Deluxe Paint IV AGA

FREE AMIGA CHALLENGE PACK

- * International Sports Challenge
- * Paradroid 90
- * Cool Croc Twins
- * Indianapolis 500

CALCULUS PRICE

£349.99

With Wordworth, Print Manager, Oscar AGA, Dennis The Menace AGA and Deluxe Paint IV

"A NEW ERA"



MONITOR NOT INCLUDED

CALCULUS PRICE

£999.99

80Mb AMIGA A4000 030 WITH FREE MORPH PLUS worth £199.99

MORPH PLUS CINEMATIC MORPHING PACKAGE

Exclusively from Calculus a professional package to challenge the powerful graphics capability of the Amiga 4000. Who else but Calculus can offer **COMPLETELY FREE Morph Plus** the superb cinematic quality morphing package. *Morph Plus* allows the creation of sophisticated full motion morphs in minutes and can be genuinely used for cinematic or professional applications.

Indeed *Morph plus* is already in use in Holly wood productions

AMIGA4000/030

FEATURES INCLUDE:

- * EC68030 Processor running at 25 mhz
- * Easily upgradable processor
- * 2 Mb of 32-bit RAM expandable to 18 Mb using industry standard 32-bit Simms module.
- * New AGA graphics chipset, giving an amazing 16.8 million colours
- * Hard Drive options range from 80 - 240 MB and includes a SCSI option.

INDEPENDENT CENTRES OF EXCELLENCE

FOR DETAILS OF YOUR LOCAL CALCULUS STORE



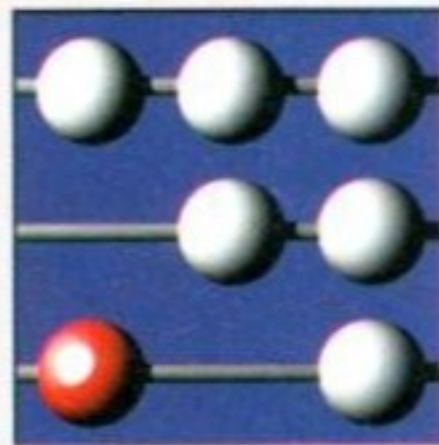

CALCULUS

COMPUTER STORES

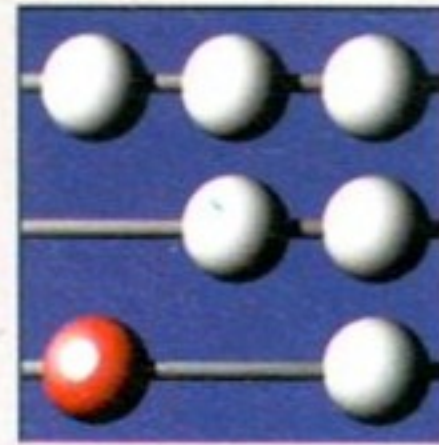

AMIGA 600 PACK

FEATURES INCLUDE:

- * Amiga A600 SD
- * TV Modulator
- * 1Mb Memory
- * 12 Months at home Warranty

FREE AWARD WINNERS VII*

Space Ace
Kick off 2
Pipemania
Populous

- Winners of the best animation European Computer Leisure Awards 1990
- Hailed world wide as the greatest Soccer game of all time
- A classic puzzle arcade game
- Golden Joystick Award - Most original game of the year.

* New version rewritten to work on Amiga 500 +1600 1600 HD and 1200.

CALCULUS
PRICE

£179.99

Amiga A600 SD + Amiga Challenge Pack.
Plus free Zappo T-Shirt and rucksack



AMIGA 600 HD EPIC PACK

This superb pack must be one of Commodore's finest, bundling 4 Games plus classic utility software with a 20 Mb Amiga 600

PACK CONTAINS:

- * Amiga 600
- * Built in 20Mb Hard Drive
- * TV Modulator
- * 1Mb RAM

Deluxe Paint III

Movie quality animations at the press of a key, 3D perspectives and a complete set of paint tools

GAMES

- Trivial Pursuits - The Classic Quiz
- EPIC - Science fiction Adventure
- MYTH - Question the judgement of the Gods
- ROME AD 92 - Role Playing Adventure

AMIGA TEXT

A powerful Word processing package simple to use but highly sophisticated you'll be amazed at your professional results

CALCULUS
PRICE

£269.99

LOWEST PRICE EVER. WHILST STOCKS LAST!!!

AMIGA 1084 STEREO MONITOR



Commodore's original and best selling stereo monitor is fully compatible with all Amiga products and gives your system the total Commodore look. With our Calculus price the 1084 Monitor has never been better value

- * Stereo Sound
- * High Resolution Display
- * Ergonomic Design
- * Full Amiga Connectivity Pack
- * Compatible with all Amiga products.

CALCULUS
PRICE

£179.99

BITS AND PIECES FROM CALCULUS

3.5" 40 cap disk box£3.50
3.5" 80 cap. Disk Box£5.50
3.5" Disk Cleaning Kit£3.75
Mouse Mat (6mm)£1.99
Mouse House£1.50
Sony 3.5" DSDD Disks£7.99
Apache Joystick£6.75
Python Joystick£9.50
Maverick Joystick£12.95
Comp Pro 5000 Joystick£11.50
Zipsticks Joystick£12.95
Turbo (QS102) Joystick£6.25
A600 Dustcover£4.50
A1200 Dustcover£4.50
Primax Amiga Mouse£12.50

COMMODORES NEW DUAL SYNC MONITOR



1940 MONITOR

This new monitor has been specially designed for the New Amiga 1200 and 4000 computers in order for you to enjoy their fantastic graphics to the full. The 1940 Monitor features built in stereo speakers

CALCULUS
PRICE

£279.99

ZAPPO EXTERNAL FLOPPY DRIVE

The No 1 Best selling Amiga drive now comes with a FREE Zapsac Rucksack



"Quality 9 out of 10 exceptional value for money" Amiga Computing Zappo External Floppy Drive Review. (compatible with all Amigas)



CALCULUS
PRICE

£59.99

WITH FREE ZAPSAC

FOR DETAILS OF YOUR LOCAL CALCULUS STORE



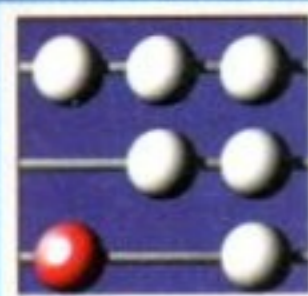

CALCULUS

COMPUTER STORES

PANASONIC AND CALCULUS THE WINNING TEAM!!

CALL AMIGA FREEPHONE 0800 444220 FOR YOUR
FREE AMIGA PRINT DRIVERS.



PANASONIC KX - P2123

Voted the Best Selling Dot Matrix Colour Printer



FREE!!!

WORDWORTH AGA

The Ultimate word / document processor for the full range of Amiga Computers. Wordworth's graphical nature makes producing documents faster and easier, with enhanced fonts, Collins Spellchecker and Thesaurus.

Wordworth's capacity for documents is limited only by the size of your disk drive and the amount of memory available in your Amiga.

FEATURES INCLUDE

The high performance KX - P2123 24 - pin quiet printer offers leading edge quiet printing technology at an affordable price.

- * **Fast Printing Speeds** - 192 CPS draft, 64 CPS LQ and 32 CP SLQ.
- * **Quiet Printing** - Super quiet 43.5 - 46 dBA sound level (most matrix printers are typically in excess of 60 dBA)
- * **Colour Printing** - 7 Colour palette (blue, red, green, yellow, violet, magenta and black).
- * **7 Resident Fonts** - Over 152,000 tpestyles using Super LQ.
Courier, Prestige, Bold PS, Roman, Script and Sans Serif.
- * **24-Pin Diamond Printhead** - High performance and high quality output.
- * **1 Year Warranty** - For total peace of mind.

CALCULUS
PRICE

£229.99

WITH FREE SOFTWARE

DATA BASE CENTRAL NUMBER 0543 251275

Bruno Brookes

Comment on the release of the new Commodore Amiga CD32

"I am stunned!...I can truly foresee a day when every DJ will want one of these in their office. Furthermore I look forward to the major record labels releasing CD's with full motion video tracks. This machine brings the future to us all.

Hints and Tips

How to use your Amiga without the mouse.

Use the arrow keys with the "Amiga Keys + shift keys" pressed down.

To select an object, press the "Amiga key and the Alt key"

Left "Amiga key + Alt key" = left mouse button

Right "Amiga key + Alt key" = Right mouse button

Arrow keys + "Amiga key" = move up, down, left, right slowly

Arrow keys + "Amiga key" = move up, down, left, right fast



Check out the list below for the nearest Calculus Computer Store

ENGLAND

CHESHIRE

CALCULUS COMPUTERS

85 Witton Street Northwich

TEL 0606 47883

MICROFUN

26 Shaws Road Altringham

TEL 061 9289299

CALCULUS COMPUTERS

51 The Mall Golden Square Warrington

TEL 0543 251275

STAFFORDSHIRE

CALCULUS COMPUTERS

Unit 30 Octagon Centre Burton-on-Trent

TEL 0283 517505

CALCULUS COMPUTERS

Unit 34 Ankerside Shopping Centre Tamworth

TEL 0543 251275

GREATER MANCHESTER

CALCULUS COMPUTERS

18a The Galleries Shopping Centre Market Street Wigan

TEL 0543 251275

TYNE AND WEAR

MAUGHAN MICROS

93 The Galleria Metro Centre Gateshead

TEL 091 493 2308

CLEVELAND

TOPSOFT COMPUTERS

7 Ramsgate Stockton

TEL 0642 670503

COUNTY DURHAM

TOPSOFT COMPUTERS

6 Wellington Court Mews Darlington

TEL 0325 486689

YORKSHIRE

MICRO FUN

Unit 12 Guardian Centre Rotherham

TEL 0709 360000

MICRO FUN

83 Holme Lane Hillsborough Sheffield

TEL 0742 345002

MICRO FUN

10 Peel Street Barnsley

TEL 0226 207063

MICRO FUN

3 All Saints Walk The Ridings Wakefield

TEL 0924 200286

DELTA PI

8 Ruswarp Lane Whitby North Yorkshire

TEL 0947 600065

LANCASHIRE

CASTLE COMPUTERS

9 Gage Street Lancaster

TEL 0524 61133

COMPUTER WORLD

146 Chorley Old Road Bolton Lancs

TEL 0204 495011

PV COMPUTERS

104 Abbey Street Accrington

TEL 0254 235345

DEVON

ANTICS

30 Royal Parade Plymouth

TEL 0752 221851

LINCOLNSHIRE

POST BYTE

1-4 Gt. Northern House Gt. Northern Terrace Lincoln

TEL 0522 525321

DERBYSHIRE

MCE COMPUTERS

13 Packers Row Chesterfield

TEL 0246 557008

NOTTINGHAMSHIRE

MANSFIELD COMPUTERS

31/33 Albert Street Mansfield

TEL 0623 631202

MICRO FUN

38 Newcastle Avenue Worksop

TEL 0909 47887

WEST MIDLANDS

CALCULUS COMPUTERS

48 Park Mall Saddlers Centre Walsall

TEL 0922 21700

COMTAZIA

15 The Arcade Walsall

TEL 0922 614346

COMTAZIA

Unit 315 Spencer In Stores Unit 3171/177 High Street West Bromwich

TEL 021 580 0809

COMTAZIA

204 High Street Dudley

TEL 0384 239259

COMTAZIA

Shopping Mall Merry Hill Centre Brierley Hill

TEL 0384 261698

LEICESTERSHIRE

MAYS COMPUTERS

57 Church Gate Leicester

TEL 0533 516789

CAVENDISH COMMODORE CENTRE

144 Charles Street Leicester

TEL 0533 510066

GLOUCESTERSHIRE

COMTAZIA GAMES STORE

Unit 25 Beechwood Place Shopping Centre

123 High St Cheltenham

TEL 0242 252767

ANTICS

79 Northgate Street Gloucester

TEL 0452 410693

ANTICS

49 High Street Stroud

TEL 0453 764487

WILTSHIRE

ANTICS

8 Regent Circus Swindon

TEL 0793 430417

AVON

ANTICS

8 Fairfax Street Bristol

TEL 0272 273744

NORFOLK / CAMBRIDGESHIRE

COMPUTER PLUS

40 New Conduit Street Kings Lynn

TEL 0553 774550

ONE STEP BEYOND

9/11 Bedford Street Norwich

TEL 0603 616373

THE GROTTO

11a Castle Meadow Norwich

TEL 0603 762914

THE LOGIC SHOP

Unit 6 Midgate Peterborough

TEL 0733 349696

HERTFORDSHIRE

THE LOGIC SHOP

2 Lynton Parade Cheshunt

TEL 0992 625323

THE LOGIC SHOP

22 The Frum Stevenage

TEL 0438 354449

WORCESTERSHIRE

ANTICS

16 St Swithin Street Worcester

TEL 0905 22075

COMTAZIA

8 Mealcheapen Street Worcester

TEL 0905 723777

WEST SUSSEX

BITS AND BYTES

High Street Bognor Regis

TEL 0243 867143

BITS AND BYTES

High Street Little Hampton

TEL 0903 723735

HAMPSHIRE

BITS AND BYTES

267 London Road Northend Portsmouth

TEL 0705 677497

BITS AND BYTES

The Cascades Portsmouth

TEL 0705 871890

KENT

MEGA BYTE

103 Elmers End Road Beckenham

TEL 081 776 6422

MEGA BYTE

14 High Street West Wickham

TEL 081 776 2766

SURREY

ANTICS

89e Woodbridge Road Guildford

TEL 0483 39115

GREYTRONICS LTD

T / A ELECTRONIC EDGE

Unit 1015 The Whitgift Centre Croydon

TEL 081 686 9973

LONDON

THE LOGIC SHOP

19 The Broadway The Bourne Southgate

TEL 081 882 4942

SCOTLAND

GRAMPIAN

HOLBURN SOFTWARE

111 Holburn Street Aberdeen

TEL 0224 211866

WALES

SOUTH GLAMORGAN

ANTICS

22 Castle Arcade Cardiff

TEL 0222 229065

INDEPENDENT CENTRES OF EXCELLENCE

Hot hatchbacks. Did you have one back in the Eighties? My mate torched his in Liverpool to get the insurance money. Love 'em or loathe 'em though, they're quick – off a shovel, if you will.

And they're making a triumphant return in *Burning Rubber*, where the *Wacky Races* meets the *Boy Racers* in an illegal race across Europe and America, organised by a chap called Fast Fred.

The introductory sequence to *Burning Rubber* is curious. Popular music group The Utah Saints perform a tune while garbled Sixties and Nineties images proliferate on screen. Words and symbols flash forth – CND and *Burning Rubber* amongst others. It's all quite disturbing, though strangely enjoyable. But that's not why you're here, is it?

To join the race, pick a hatchback – there's a choice of six – then stop off at Fast Fred's Speed Shop,



Burning Rubber is often a case of damage limitation. Each time you have a bump, the damage percentage rises. Drive with caution and you last a lot longer – unfortunately though, you won't win the race. Robert Mark's advice would be to drive like a madman and hope for the best – probably.

BURNING RUB

Phoaaar! Vauhall Chevettes, Renault 5s, all those sensible motors scudding around Europe in an illegal race – watch out Nigel!

soup-ups a speciality. You're greeted by a woman in a rather skimpy outfit, just like at Kwik Fit, tempting you into parting with a few dollars. You've got \$4,000 in the kitty, so spend it wisely.

There are various car parts on offer, all of which improve your car's performance; for instance, Nitros give you great acceleration but only for a limited amount of time; Brakes increase your braking speed. You can even add one of those charming body kits that improves the handling, or is it the looks? Or maybe nothing.

Foot to the floor

Before you finally get to put your boot on the accelerator (which is

why you're here), you have to pick a racing route. Options abound as you peruse the map, looking for a short route to the chequered flag.

But beware, the shorter routes often involve many junctions and you constantly have to slow down. And who in their right mind wants to cruise around Scotland in a Peugeot 205 GTi at anything less than break-neck speed?

Apart from the obvious dangers of crashing, there are other hazards. That hardy-perennial – the speed trap – crops up: the cops give chase and you can either try and burn them off and risk crashing, or play a patient game and wait for a gap, then go hell for leather, however, if



Before each section of the race there's the routemap. Plan your path to the chequered flag carefully. Longer routes with sweeping bends are often preferable to using junctions which slow you down.

you stop completely the cops will nab you, and that means jail.

Civilian cars are white and travel slowly – they're easy to overtake – while the black cars are

competitors with drivers with varying degrees of skill.

After Scotland, there are other parts of Europe to negotiate, and with varying conditions to tackle.

SO, YOU'VE BEEN DOWN TO THAT LONDON AND THAT PARIS AND THAT BERLIN...

A hot hunchback means Europe is a cathedral to your racing skills – damn, that should have been 'with a hatchback!' Oh well.



It would've been nicer to drive around Scotland in a Triumph Stag rather than a Fiesta.



The capital is not the best of places to hurtle through in darkness with cops on your tail.



When overtaken by the Old Bill, be careful not to slow to a halt because they imprison you.



I remember when the police drove Vauxhall Chevettes – now there was a hot hatchback.



"Nicole". "Papa". "Nicole". "Papa". "Nicole". "Papa". Good advert that. But that was for a Clio and the one on here is a Renault 5.

London, for instance, has high police activity and poor visibility – you race in virtual darkness. Paris is stormy and Germany has blizzards.

At the end of each level, you can go back to Fast Fred's for add-ons to increase performance, but only if you've can afford them. Crash too often and you'll have to fork out for repairs. Once in America (it takes ages to get there, believe me), you get to choose a new motor, and the courses offer slightly different hazards, including pedestrian areas.

BER

“ You have got \$4,000 in the kitty, so spend it wisely ”

Chequered flag

Burning Rubber is a strange bird. The graphics are nicely drawn and you get a decent feeling of speed, particularly when you fire the Nitros into action. The view, from behind your car works well, but somehow it isn't quite enough.



When you win races you get a cash prize and Fast Fred's Speed Shop is where get you spend it. But remember to save money for repairs.

An injection of humour would have been nice – the odd deer running across the road, or maybe a peleton of cyclists hurtling around the corner. And a two-player option would have added an extra dimension.

In a number of words, and for want of a more exciting and turbo-charged summation to this reasonably average arcade conversion, it has to be said that *Burning Rubber* drives well but adds very little to the genre.

Stephen Bradley

BURNING RUBBER



PROGRAMMERS

Dynafield Systems

PUBLISHER

Ocean 061-832 6633

PRICE

£25.99

RELEASE

Mid September '93

GRAPHICS

Nicely drawn.

SOUND

Sort of vroomy.

ADDICTION

More Mini than Maserati.

PLAYABILITY

Drives like a GTi.

VERDICT

“ It's a car race around the world lacking in humour but with some pleasant graphics and the odd bit of police-car-chase action. An Astra not a Porsche. ”

78%

NODDY'S™ BIG ADVENTURE

Noddy's Big Adventure is the sequel to the highly successful Noddy's Playtime. It takes children to the North West corner of Toyland and includes 13 different programs to educate and entertain children for hours on end.

This graded creativity and entertainment package is specifically designed for 3-7 year olds and relates to the early requirements of the National Curriculum.

Drive with Noddy in his car, pick up passengers along the way and visit many exciting locations.

- Kitchen Fun - sequencing, colour and shape matching and vocabulary
- Noddy's Scales - number matching through to addition
- Tricky Trees - memory, sequencing and the language of colour and shape
- Can you Find me? - shape and colour recognition
- Bert's Scrapbook - sequencing and reading skills
- Beach Sorter - sorting
- Picnic Attack - water fun game

Junior Word Processor - this excellent utility develops story telling skills. Its scope is outstanding and features many facilities found in 'grown up' word processors. There is also a word game in each level to create an element of fun.

Available for: Amiga, Acorn Archimedes, PC and PC Windows.



NODDY'S™ PLAYTIME

Noddy's Playtime added a new perspective to educational games, the outstanding value from this extensive package has set new standards of parental expectation in this important area of software based on learning with fun.

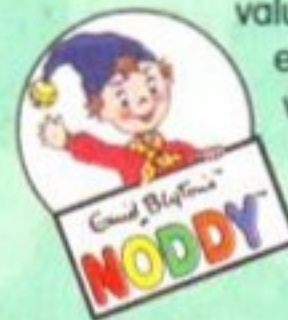

Drive around Toy Town, explore exciting locations and learning programs and a full Junior Art Package packed full of creative fun. Designed for 3-7 year olds.

Available for: Amiga, Acorn Archimedes, PC and ST.

PLAYTIME & BIG ADVENTURE TWICE THE LEARNING EXPERIENCE



THE JUMPING BEAN CO.

Leen Gate Lenton Nottingham NG7 2LX
Tel: 0602 792838 Fax: 0602 780963

Available from: Boots, Currys, Dixons, Escorn, Future Zone, Game Ltd, John Lewis, John Menzies, PC World, Ryman's, Tandy, The Computer Store, Virgin and many specialist outlets.

Original Text and Images © Darrell Waters Ltd 1989/90. Text and Images of BBC Television Series © BBC Enterprises Ltd 1992. Licensed by BBC Enterprises Ltd. NODDY is a trademark of Darrell Waters Ltd and is used under Licence. ENIG BLYTON (signature logo) is a trademark of Darrell Waters Ltd and is used under Licence.

Forget the idea of the girly 'new man'. It's your hulkiness that makes things happen in this space-based skirmish war game, so pump up your pecs and prepare for battle...

Being a man is what being a Space Marine is all about. Not a girlie-swot 'new man', but a big, tough, bio-engineered man with a ridiculously large suit of armour sporting the sort of weaponry that usually adorns a tank.

Space Hulk gives you the opportunity to play a whole team of such hormonally unbalanced Übermensch and shoot lots of nasty aliens in the process. It's based on the massively successful *Warhammer 40,000* game that uses funny shaped dice and has ruined the eyesight of many a modeller painting the little figures.

You play the Imperial Captain of the Dark Angel chapter of Space Marines and control a squad of terminators. These are heavily equipped nutters with no fear of death. Just as well because lots of them end up dead and it doesn't seem to put them off.

KIII KIII KIII

The eponymous Space Hulks are vast derelict spaceships that wander through warp space and are home to colonies of Genestealers. Your missions revolve around entering the Space Hulks and doing battle with the Genestealers. These loathsome creatures do horrible things to people given half a chance, so your response is simple: you kill them.

There are 14 training missions and 37 missions proper. Most are fairly short and involve retrieving objects, getting to a set place or just blasting the hell out of as many creepies as you can. There are two main screens, a first-person view from each terminator and a Planning

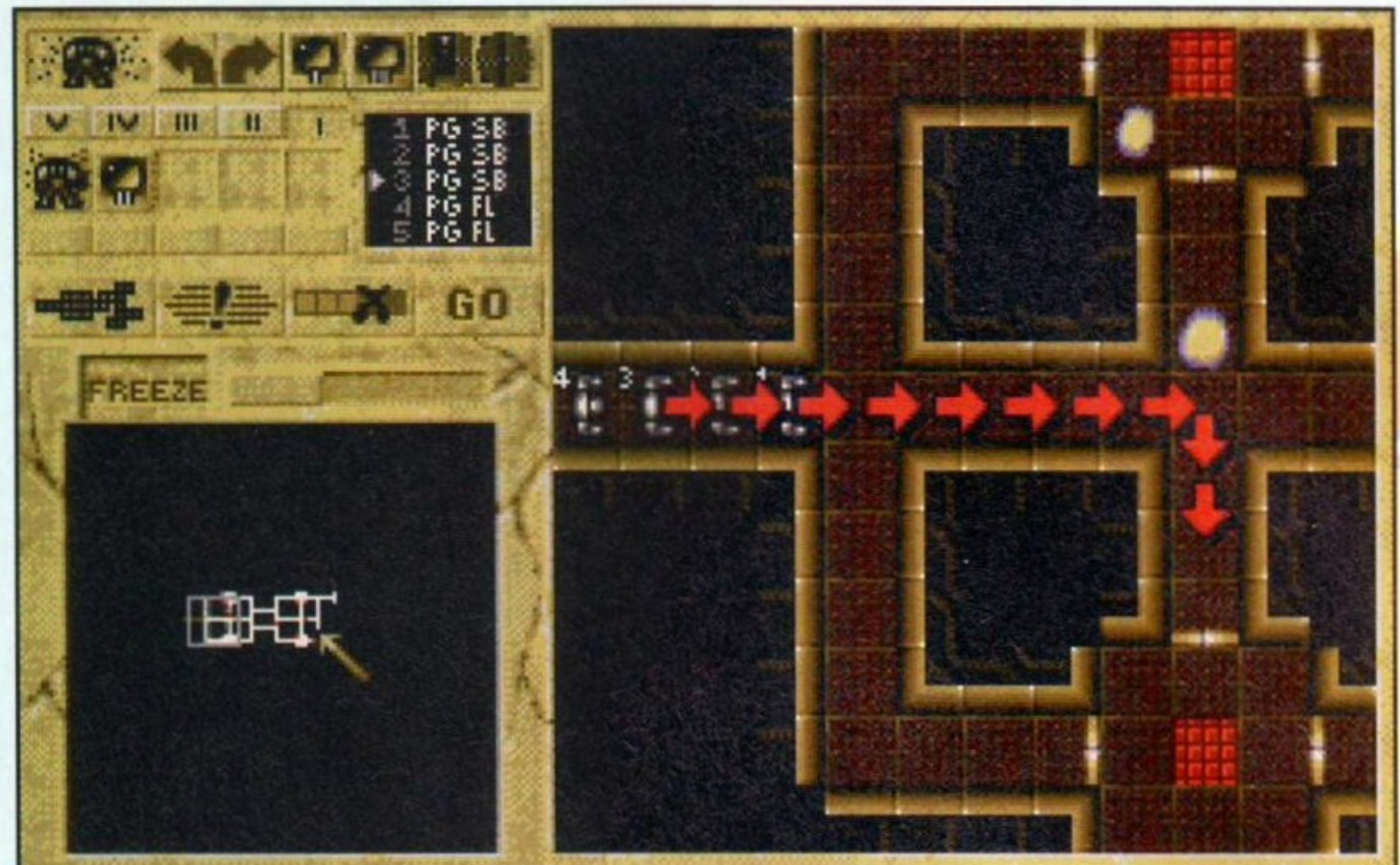

The all-important order giving part. Each marine needs to be positioned very carefully. Leave one stranded or pointing the wrong way and you'll lose him.

SPACE HULK



screen. The action takes place in real time but can be frozen at any point, which is handy because things happen pretty quickly. You are only given a limited amount of 'frozen time' to play with though, so you've still got to think quick.



Oh to be among those macho marines! What a bunch of posers, eh?

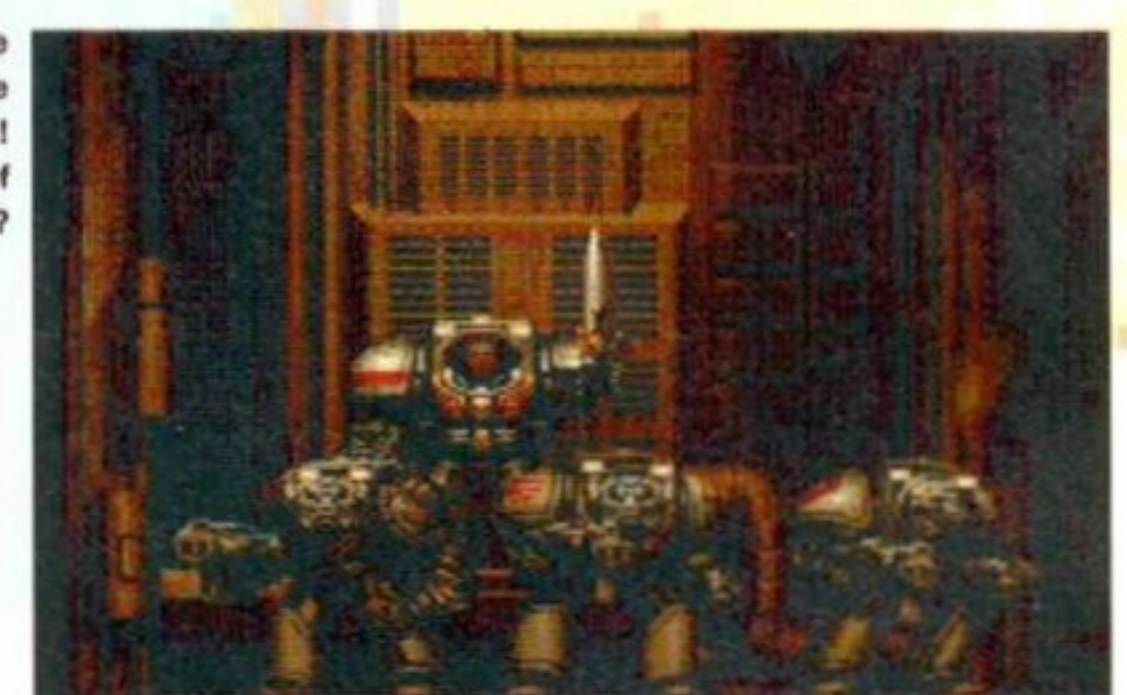

From the Planning screen you can issue orders to each marine, to move them about, open doors and shoot. From the View screen you can see what each marine sees and you can take direct control of them.

While not under direct control marines can be left in Overwatch. They will fire at any alien that crosses their line of sight, but won't turn around and so will get mashed if some sneaky alien scum catches them from behind. Some missions can be played using just one screen

– the two methods of control are awkward at first, but the trick is to freeze things regularly to keep track of what's going on.

Complete control

First stop is giving your walking tanks some orders while the action is frozen. Each marine is assigned a destination or course of action by clicking on a series of icons. Then you can switch to the view screen, unfreeze things and watch them

clump about. If a Genestealer jumps out unexpectedly you can intervene and take control of the blasting. You can also leave your chaps to it and hope they manage; or freeze things and go back to the Planning screen to adjust your strategy.

The game tends to go in little spurts of adrenaline with the real-time business at the View screen although this is interspersed with more thoughtful tactical manoeuvres at the Planning screen.



Before each mission you are briefed and urged on to death or glory, or perhaps both, by your cheery chapter commander, Julian.



Some Marine icons have a neo-fascist edge, with double-headed eagles and skulls. 'Politically correct' persons may want to play in secret.

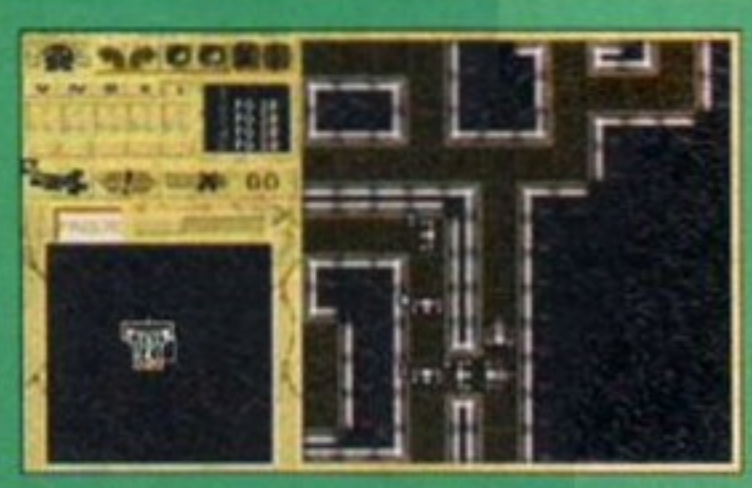

The Planning screen gives you an overhead view of your marines and is where you issue their marching orders.



If you don't fire now, you can kiss large parts of your body goodbye. Genestealers move quickly and you only get a few seconds to respond.



The view screen shows you the forward view from each terminator. From the main bottom window you can take direct control.

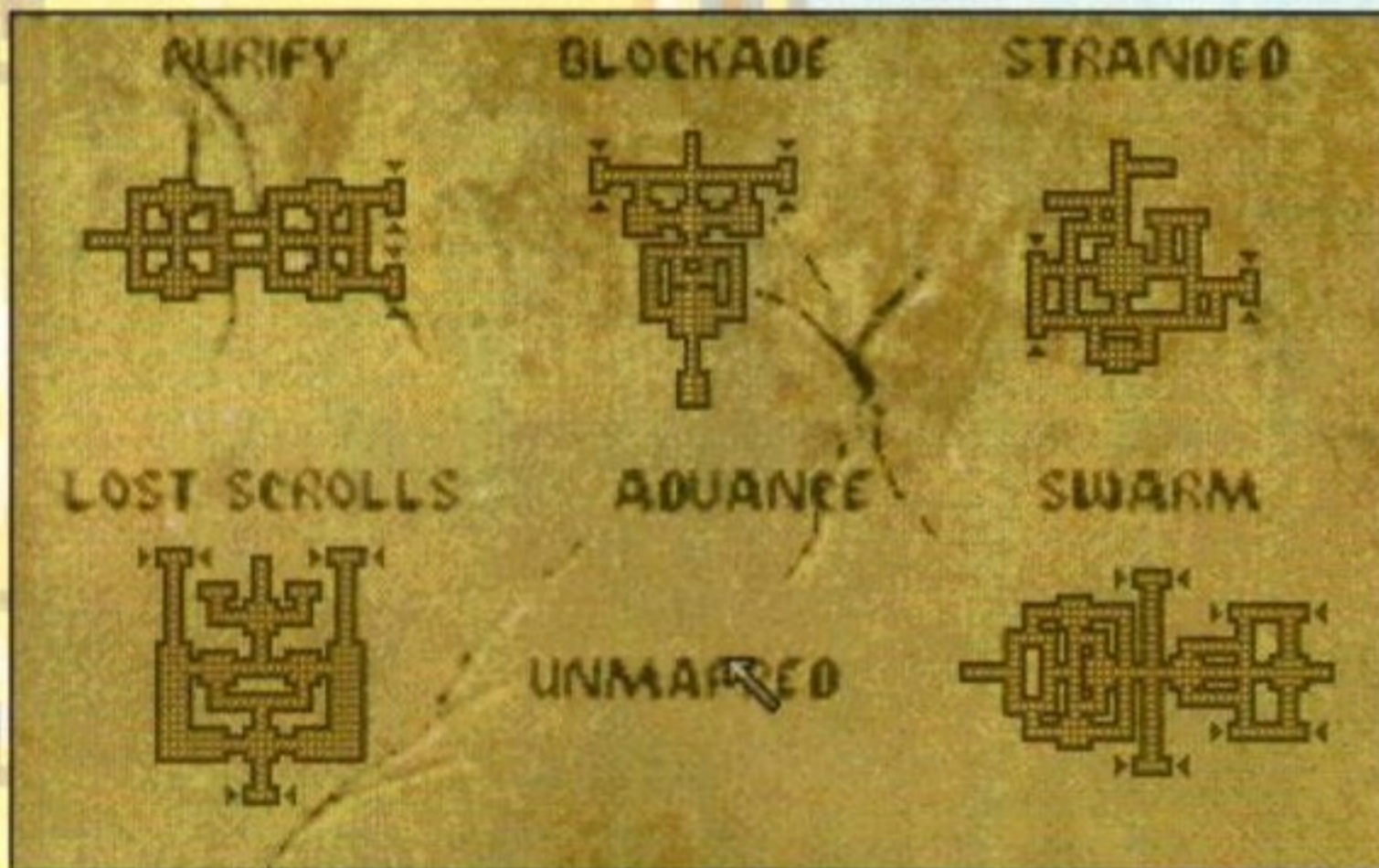

Some of the multitude of *Space Hulk* missions. The areas to explore are small and generally packed with Genestealers so there's no tedious wandering around looking for trouble, it's trouble from the off.

The tension is built up nicely from the outset. You feel like that bloke in *Aliens* as he watches his team of marines on the TV monitors.

It's dark in there

The graphics are suitably dark and moody and convey the claustrophobic atmosphere well without being outstanding. Dark music sets the scene and sound effects – shooting, screams, footsteps and more shooting add atmosphere. However, the

game comes on three disks so if you only have one disk drive there is lots of tedious disk swapping.

There are also many tutorials – this game isn't easy and even hardened game players are in for a testing time. Having spent a few minutes choosing, loading and being briefed it can all be over in a few seconds of mayhem. It takes patience to get to a point where you can kick some butt without getting your own soundly whipped.



Among the terminator weaponry are assault cannon, thunder hammers and this little number, a heavy flamer.



One of your terminator marines buying the farm. You can easily lose the entire squad in seconds if you leave an approach route open.

If things go wrong you are immediately taken out of the mission, often you don't even see what got you or where you went wrong. You just watch with dismay as the view screens for each man are splattered in blood. Missions require careful planning – the skill is in carefully moving your team so all your backs are covered.

You're dead

Space Hulk will undoubtedly be loved by the same sort of people who are into the original *Warhammer 40,000* stuff. It requires attention to detail, planning and a good deal of tactics interspaced with snatches of fast reflexes. Switching in and out of real-time gives the game a very stop-go feeling.

The mix of arcade and strategy might annoy purists from each school, but the mix works reasonably well. Only occasionally do you die for no better reason than you were too slow with the mouse.

There is a great sense of urgency as you watch the Genestealers close in on your position. It can be frustratingly difficult, entire teams wiped out time after time as you try to get the hang of a mission.

If you long for an alter-ego crackling with testosterone and want to take jaunts into the bowels of huge ruined space ships hunting and being hunted by vicious alien life-forms then, er, you're probably a bit weird, actually.

Space Hulk should be right up your street as long as long as you can hack the skirmish wargaming elements and are patient enough to get into it. Suck this alien scum.

Rob Mead

SPACE HULK



PROGRAMMERS

Nick Wilson

PUBLISHERS

Electronic Arts 0753 549442

PRICE

£34.99

RELEASE

Out now



GRAPHICS



Suitably dark and moody.

SOUND



Lovely atmospheric SFX.

ADDICTION



Gripping stuff.

PLAYABILITY



Terribly frustrating at times.

VERDICT

“ A moody, tense and sometimes difficult exercise in alien-trashing for the criminally macho and/or tactically minded. Very good but not brilliant. ”

77%

AMIGA FORMAT GAMES SPECIAL

**FROM THE MAKERS OF
AMIGA FORMAT COMES A
TRULY SPECTACULAR
EXPERIENCE...**

THE GAMES SPECIAL!

**THE AMIGA FORMAT
GAMES SPECIAL IS
ESSENTIAL READING FOR
ALL AMIGA GAMERS.**

BUY IT NOW...



IT'S ON SALE RIGHT NOW!

FROM THE MAKERS OF THE WORLD'S BEST-SELLING AMIGA MAGAZINE

AMIGA FORMAT SPECIAL

SPECIAL ISSUE 7 ■ £3.95

GAMES



STOP RIGHT NOW

We'll shatter your illusions
about games... forever!



PRICED AT £3.95



That pesky poffin's pinching my peg! The grey ones nick your pegs while the brown ones rust your cogs, and the last thing you want is rusty cogs.

GEARWORKS

Puzzles always seem easier to the person looking over your shoulder. Maybe it's the extra distance from the problem, but it is a proven fact that if one person is trying to solve something, an innocent bystander will always come up and say "You don't want to put that there!". Annoying enough when you've nearly finished, but if that was your last life it leaves you even more determined to beat the blessed thing.

I suppose that's the appeal of things like *The Crystal Maze*, an excellent puzzle/physical game enjoyed from the comfort of your armchair. Cries of "What on Earth is he doing?" and "She's done it all wrong!" abound while you are left thinking that you could have done better yourself. Well, this is your chance to prove it!

Walking the cog

Imagine the task: 12 of the world's famous monuments are to be made into clocks. This is not a bizarre advertising strategy, merely the point

of the game. Your job is to fit together cogs of varying sizes on pegs in play areas inside the monument, in order to connect a number of red cogs. When all the red cogs are connected to the motor, and everything is running smoothly, then you can move on to the next play area. When each level is finished you are rewarded with a glimpse of your clock in full working order. If there's a spanner in the works, so to speak, then the motor will heat up. When it gets too hot it will shut down. You lose a life and must start the level again.

It all sounds devilishly simple – all you have to do is join the cogs up. There lies the problem. The cogs are selected for you and their order is totally random – shades of the ever-popular *Tetris* here. It's infuriating when you're one cog away from finishing the play area, level and clock (game, set and match), and all

the cogs are the wrong size. You've got to find somewhere to put them, and this may mean blowing up ones you've put down already. Then you run out of bombs so you can't free the cogs up when you put one in the wrong place.

Like all puzzles it's good to have some sort of a strategy. Knowing how the cogs fit together helps, but racing round in circles trying to join up the later levels when you're running out of time is

exasperating. Isn't that why you play this sort of game? Isn't it because of that pull which turns that "one last try" into staying up until the wee small hours determined that a few simple puzzles aren't going to beat you? You don't realise the addiction until you finish the last one.

Gearworks is addictive, frustrating and deceptively simple. Any chance of *Gearworks (The Sequel)*?

Stephen Bradley AF

"You'll be quite determined that a few simple puzzles won't beat you"

GEARWORKS



PROGRAMMERS

Hollyware

PUBLISHER

Soft're B'sness 0480 496497

PRICE

£19.99

RELEASE

September 23rd '93



GRAPHICS



Simple but cute.

SOUND



Lots of clangs and squeaks.

ADDICTION



Haven't seen the dog for days.

PLAYABILITY

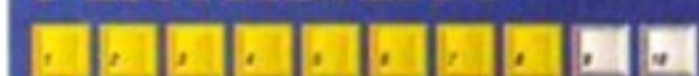

Try getting me off it.

VERDICT

"Sort of quite enjoyable, really. But I can take it or leave it. You can't take it back now, though, not when I'm so close to the end. Just ten minutes, I promise..."

72%



Take two bottles into the shower? Not me! I'd much rather spend my time turning the Statue of Liberty into a digital watch...



Where shall I put this last cog? There's a gap near the end but I'll get more points if I join up the other cogs. Problems, problems, problems.

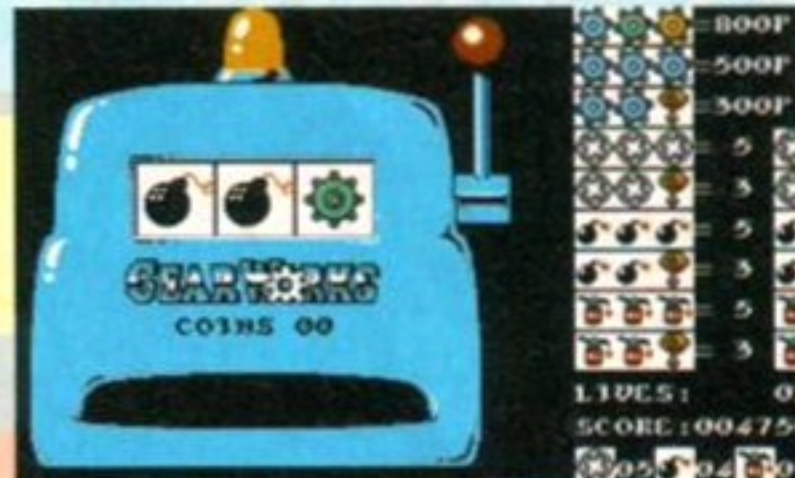

Welcome to the *Gearworks* Bonus Round! Play the machines to collect some of those can't-quite-get-enough-of-them bombs.

CAPTAIN YOUR TEAM TO VICTORY

IN THE GREATEST INTERNATIONAL
TEAM MATCH IN GOLF -
THE RYDER CUP BY JOHNNIE WALKER.

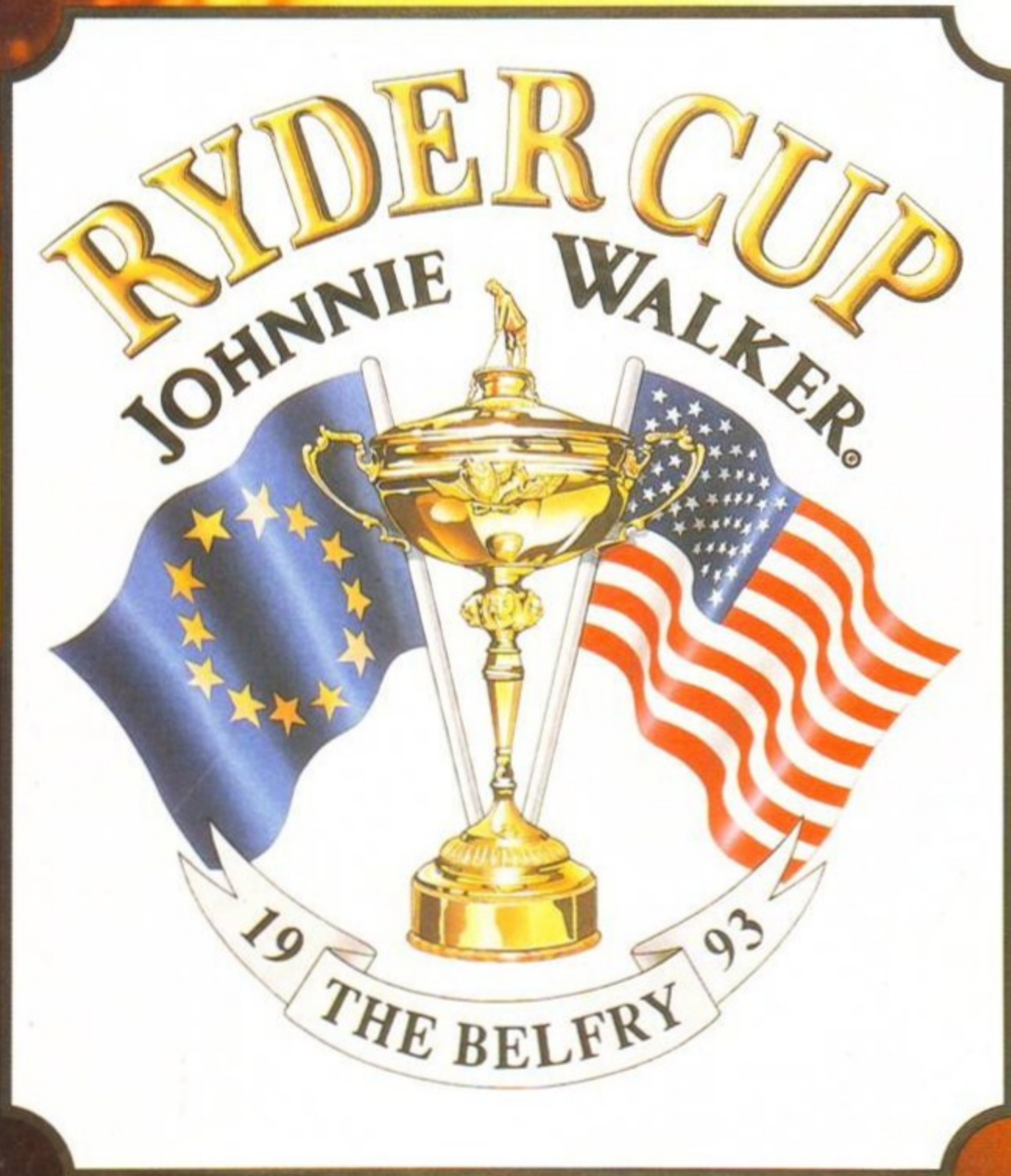

TM & © 1993 PGA Officially Licensed Product



AVAILABLE FOR
A1200
PC & COMPATIBLES
AMIGA

CALLERS WELCOME AT OUR BRANCHES OPEN 9-5.30, MONDAY TO SATURDAY, (10-4.30 SUNDAYS ST ALBANS ONLY)

WARNING

Due to the exchange rate, or manufacturer's changes or due to current RAM shortage, some prices may alter, either up or down, during the several weeks between going to press and the end of the month of issue. We would ask that, where possible, prices be confirmed by telephone before ordering.

OLD AMIGA TRADE-IN

The best trade-in allowance, extra for peripherals and accessories. Trade in your old machine for a brand new A600/1200/4000/CD32 or even a PC. After trade-in, equipment is checked and refurbished by our engineers and is then offered at bargain prices, complete with 3 months warranty.

A500s FROM £139
A1500s FROM £199

A600 SD/HD.....	from 159	HD's + Controllers..	from 179
A3000s.....	from 499	GVP HD8 40/52.....	209/229
CDTV.....	179	XT/AT BBoard.....	79/129
A590 20/40MB.....	129/159		

OTHER ACCESSORIES - PLEASE ASK.

COMPUTING ESTABLISHED 9 YEARS

10 MARKET PLACE ST ALBANS
HERTS AL3 5DG TEL: (0727) 856005/841396
THE GALLERY ARNDALE CENTRE LUTON
BEDS LU1 2PG TEL: (0582) 457195/411281

A4000/30 & 40

A4000/30: AGA Chip Set + 68030 processor, 68882 25/50 MHz co-processor option, 256,000 colours from 16.6M, scan doubling for flicker free display, Mouse, Amiga 3.5"/1.76 MB 3.5" drive, Hard Drive as below, Amiga DOS 3.0 system and utilities, **Gold Service on-site warranty**
A4000/40: As above, but featuring the blistering 68040 processor, with full floating point facilities.

HD SIZE MB	FPU MHZ	STANDARD VERSION		SUPER EXPANDABLE VERSION		EXTRAS
		2+2MB	2+4MB	2+4MB	2+4MB	
80	25	989	1099	1889	ADD £100	Extra 2MB for 2+2 versions £99 • Extra 4MB for 2+4 versions £159 • Microvitec Cubscan 1440 recommended £399.99
120	25	1089	1199	1969	ADD £100	
160	25	1279	1329		ADD £100	
214	25	1349	1399		ADD £100	
240	25	1175	1299	2089	ADD £100	
340	25	1299	1419	1969	ADD £100	
540	25	1629	1529	2679	ADD £100	
	50	1749	1869			
	50					
	50					

TRADE IN AVAILABLE

HOW TO USE THIS AD
Exclusively from Hobbyte, you can choose your own Amiga and software combination and still benefit from the huge savings only available from package deals. Want an A500 pack for small children? No problem! A professional pack for music or programming? It's up to you!

WE WANT TO BEAT ALL PRICES! CALL US!!

CD32 CONSOLE LIMITED STOCKS END AUGUST

CD32 SOFTWARE £285
15 to 20 titles specially written for the CD32 should be in stock by the time you read this, including Syndicate, Zool 2, Jurassic Park, Chaos Engine, Robocod, Diggers, many of which include a full CD music track alongside the game. About half of existing CDTV titles are compatible. CD32 will also play normal music CDs and CD+G discs.
Includes 2 free games and joypad

COMING SOON....
Full Motion video add-on - for movies on CD32 Floppy Drive - SOON!!
CD32 for A1200 - no dates yet
If you would like updates on the latest info as it arrives, plus first option on initial stocks, ask to be added to our priority customer list

BEST PRICES BEST RANGE FROM HOBBYTE

A500/600/CDTV

STARTER PACK
A Must for new users!
Microswitched joystick, "Get the Most from your Amiga" book, 10 Blank discs, 80 capacity lockable disc box, mouse mat, dust cover, Virus Killer.

A500+ and A600 come complete with mouse, modulator to connect to TV, or monitor lead as required, all cables, manuals, operating discs and utilities

	INCLUDED AS STANDARD	ALONE	PLUS STARTER	WARRANTY	EXTRAS
A500+ 1MB		179.99	194.99	12 months return to base	Extra 1MB £25
A500+ CARTOON CLASSICS	CAPTAIN PLANET, LEMMINGS, THE SIMPSONS, DPAIN'T III*	194.99	209.99		
A600 SD 1MB		184.99	199.99		Extra 1MB £35 • 2MB PCMCIA £109
A600 SD WILD, WEIRD AND WICKED	SILLY PUTTY, F1 GRAND PRIX, PUSHOVER, DELUXE PAINT III*, 700 CLIP ART SET	199.99	214.99	12 months at home	
A600 HD 20		259.99	274.99		
EPIC PACK PLUS	30 EPIC, 40 ROME, MYTH, TRIVIAL PURSUIT, 64 AMIGA TEXT, DELUXE PAINT III*, 700 CLIP ART SET	289.99	304.99		
A600 HD 80		365.99	379.99	12 months return to base	
120		415.99	429.99		
210		569.99	584.99		
CDTV MULTI MEDIA	AUDIO DISCS/ CD PLAYER, KEY'S, FORIVE, MOUSE, REMOTE CONTROLLER, CADDY, WELCOME DISC, FISH DISC	229.99	244.99		Brickette £45
CBM 1084 ST	TILT AND SWIVEL + LEADS	179.99		1 year	PIP Monitor to TV Converter - £114
CBM 1940	LEADS. IDEAL FOR AGA LEADS.	279.99		1 year	
Philips 8833 II	T & SWIVEL £10	189.99		at home	
Star LC100C	TOP VALUE 9 PIN COLOUR PRINTER	149.99	159.99	1 year	
Citizen 240C	24PIN COLOUR PLUS FREE PEN PAL	259.99	269.99	2 year	

Return to base HD versions are SD units fitted with top quality 3rd party drives and come with install disc + full documentation. *DPHII needs 2MB for animation on HD models.

NO OTHER DEALER CAN BEAT OUR CREDENTIALS

- Multi-million company with 9 years experience in Commodore product and here to stay
- Commodore trained staff are friendly and helpful and are parents, multimedia, educational, games, programming or technical specialists (usually more than one!)
- Open 9-6 pm Monday to Saturday and 10.00 am to 4.30 pm Sundays (St Albans only) for convenient shopping.
- Callers welcome for advice and demonstration at our 1600+ sq ft High St, Town Centre branches
- Same day despatch for most orders received by 5.30 pm; express am and Saturday services available
- Hardware carefully handled and delivered safely and reliably by caged, insured, top name courier service
- Pre-despatch testing on Amiga systems
- Free 30 day courier collection and delivery of NEW replacement (except product with on-site maintenance)
- Hotline support and in-house engineers
- Upgrade and trade in offers to keep you up to date
- Exceptional after sales service
- BFPD and export welcome

NOT JUST ANOTHER MAIL ORDER COMPANY

For years a major player in Amiga Mail Order, Hobbyte also boast extensive expertise and experience in specification and support of multi-machine and specialist systems. Hobbyte have been recommended and trained by Commodore and successfully won major orders and support contracts from London Boroughs, MOD, educational establishments etc. We are pleased to be placed on tender lists. This expertise is available to all our customers.

HOBBYTE VALUE PACKS

Hobbyte are famous for their packs, allowing you to choose what you want, whilst still benefitting from package deal savings. Remember, a bargain is only a bargain when you like what you get! So, if you aren't Wild, Weird or Wicked, Sleepwalker sends you to sleep, Space Ace leaves you feeling empty and Paratrooper does worse, if Basic basically isn't you, exercise your options and get real value for money from Hobbyte

TRAMPY'S AND NODDY'S PACK

Fun and educational for 2 to 11 years
(Some help may be required)

	WITH AMIGA	ALONE
Noddy's Playtime	£45	£59
OR Merlins Maths		
The Shoe People OR Fun School 2		
Fun School 3 or 4 OR ADI Jr Reading OR Counting		
Deluxe Paint II + 700 Clip Art pics		
Hobbyte Primary Educational PD Pack		
Hobbyte 30 Easy Children's Games Pack		

SERIOUS USER'S PACK

Interested in music, programming and graphics? Then this pack is for you!

	WITH AMIGA	ALONE
Easy Amos	£39	£49
OR AMOS Professional ADD £10 for this option		
Hobbyte AMOS PD Greats		
Deluxe Paint III, plus 700 Clip Art pics		
MIDI Recording Studio & MIDI Interface		
OR AmigaVision		

STARTER PACK

A must for new users! All you need in one value pack

	WITH AMIGA	ALONE
10 blank discs	£15	£25
Virus Killer		
Mouse mat		
Plus Microswitched Joystick, 80 cap. lockable disc box, Dust Cover		

HOT BUG GAMES PACK

The top-selling Hobbyte Hot List pack now includes the ultimate joystick!!!

	WITH AMIGA	ALONE
10 "Hot List" Games The GREATEST!	£44	£59

"THE BUG"
The only joystick ever to be given a Gold rating 92% AF, positive single-handed action, small and lovely!
See listing to the right for current HOT LIST, or phone for latest changes. Children's games available.

80 Prog. Hobbyte PD Greats Pack II 10 blank discs, mouse mat, 80 capacity lockable disc box, plus dust cover
Includes top games like Battletechs, Star Trek, Computer Conflict, Megaball, dozens of arcade classics, board classics and 'shoot-em-ups', Utilities, Word Processor, Spreadsheet, Database + Desktop Publisher and the ultimate virus killers - a must for every Amiga owner!

HOME APPLICATION PACK

Perfect for all Home Office needs

	WITH AMIGA	ALONE
Virus Killer Disk, 80 Prog. Hobbyte PD Greats Pack - see 'Hottest Lot Pack' The Works Platinum Deluxe Paint III* with animation + 700 Clip Art pics Digita Home Accounts Any Two Hot List Titles	£35	£49

THE HOT LIST

GREAT individually packaged games, BETTER THAN THE REST!! (previous RRP's up to £39.99 each)

- Thunderbirds (7yrs+) †
- F1 Grand Prix - 92% AF
- Silly Putty - 90%+ lots of mags
- Eiff/Toki/Puzznick (counts as 2) †
- Paperboy II †
- Hunt for Red October
- Colossus Chess @
- Challenge Golf
- Battleships classic board game
- Graeme Souness Soccer
- Neighbours
- Frankenstein † @
- Captain Planet
- Silkwood Helicopter 93% CU
- Edd the Duck †
- Stack Up †
- Lemmings 92% AF
- Round the Bend †
- Continental Circus - 8 race circuits 92% AA@
- World Cricket
- Bart Simpson
- Spiderman/Cptn America † @
- Ice Hockey
- Xenon - C+VG Game of the Month
- Blade Warrior - A Power, AF, AAction superb reviews
- Toobin Rapid riding

† PARTICULARLY SUITABLE FOR CHILDREN (MAY NEED HELP) @ NOT AT 1200 COMPATIBLE TITLES MAY VARY

*DPHII needs 2MB for animation on HD models.

MONITORS/ACCESSORIES

Philips UK 8833 MKII mon.+leads + on-site	189.99
Tilt & swivel stand for 8833	9.99
CBM 1960 High res monitor	359.99
CBM 1940 dual sync .39 dpi AGA monitor + speakers	274.99
CBM 1942 dual sync .28 dpi AGA monitor + speakers	374.99
MICROVITEC CUB-SCAN 1440 14" 28dp for 1200/4000, infinitely variable scan rates between 15KHz (default on boot-up) and 40 KHz for all AGA modes in this range. With tilt and swivel stand and 3 year warranty	399.99
Microvitec Cub-scan .28dp for 1200/4000 as above, but 20"	1139.99
Adaptor for A1200/Microvitec	12.99
EIZO 9060M Multi-Sync for 1200/4000 models	595.00
CBM 1936 Hi-res SVGA .28dp inc. tilt & swivel	259.99
NEC 4FG Multi-Sync	544.99
PIP View TV tuner+remote with sub picture for monitors	113.99
Philips Brilliance 2110 21"	POA
CBM Flicker Fixer	99.90
ICD Flicker Free Video 2-A500	184.99

FLOPPY DRIVES

Zyder 3.5 external drive, daisy-chain + on/off	51.50
Comano CAX 354 3.5 external drive, beige	56.50
PC 880B with anti click + Blitz back up and virus protector	64.99
PC 880B as above, Cyclone compatible	69.99
Dual drive as PC 880B	124.99
Replacement A500 drive	39.99
High density 1.76MB ext. drive for any Amiga (WB 2) + 10 discs	94.99
A2015 high density int 1.76MB 3.5" drive for 1500/2000	78.95
A3015 high density int 1.76MB 3.5" drive for 3000	78.95

HARD DRIVES/ACCELERATORS

1500/2000			
GVP HCB/II 40MB	278.99	A500 Internal 80MB HD	279.99
GVP HCB/II 80MB	314.99	A500 Internal 120MB HD	339.99
GVP HCB/II 120MB	358.99	Trifecta SCSI 80MB HD	289.99
GVP HCB/II 213MB	566.99	A570 for 2.04 1MB 500	139.99
G Force 030 25MHz 1MB	384.99	A600/1200	
G Force 030 40MHz 4MB	684.99	GVP 85 MB HD 600/1200	274.99
G Force 030 50MHz 4MB	984.99	GVP 1230 030 accel for 1200	284.90
G Force 040 33MHz 4MB	1284.99	GVP1230/40MHz/4MB 68882	
Extra 2MB for above	POA	Co-Pro for 1200	479.99
Trifecta SCSI 80MB HD	234.90	M1230 XA 40MHz	269.99
3000/4000		M1230XA 40MHz 4MB	429.99
Proq Mercury 040 28MHz (3000)I	349.99	M1230 XA 50MHz 4MB	519.99
SCSI II controller for 4000	229.99	Microbotics XL130 25MHz	219.99
Syquest removable HD 88MB	658.99	VXL 30 40MHz	339.99
Syquest for A4000	POA	2MB Burst RAM for above	179.99
500		A600/1200 HD UPGRADES	
A530 1MB 40MB	479.00	SELF FITTING*	CBM APPROVED FITTING**
A530 1MB 80MB	579.00	(on-site invalidated)	(with on-site)
A530 1MB 120MB	679.99	20MB	115
A530 1MB 213MB	749.99	40MB	145
A530 68882	218.99	60MB	175
GVP HDR 42MB	249.90	80/85MB	189
GVP HDR 80MB	324.99	120/127MB	265
GVP HDR 120MB	458.99	209MB	365
SOME HDs REFURBISHED AVAILABLE FROM £209		INTERNAL CLOCK	POA
A590 20MB	199.99		
A500 Internal 20MB HD	184.99		
A500 Internal 60MB HD	249.99		

AMIGA 24 BIT HARDWARE

DCTV	376.99
GVP IV + VIU-S	965.99
GVP IV + VIU-CT	1255.99
Impact Vision 24	POA

HARLEQUIN 32 BIT FRAMEMAKER BOARD

Sets the standard by which broadcast quality output and true colour display is judged. Easily integrating with studio + office setups, it has been professionally used to storyboard + animation + commercial production in the world of TV.

- 16.7 million colour photo realistic display • real time 24 bit animation
- Optional Alpha Channel - superimpose high quality graphics onto live signal, or smoothly blend point images • Optional Double Buffering - 2, 24 bit displays instantly available

Unrivalled range of professional s/w support: TV Point • 32 bit point • VLab • real time 24 bit digitiser • Caligari Broadcast • 3D anim with virtual reality interface • Sympatica II single frame control system • Art Dept Pro • image processing inc mixing, scaling, time stretch • Real 3D V2 - 24bit modeller + others

H1500 1.5MB	£929	*H2000 Plus	£1479
H2000 2MB + Alpha	£999	*H4000 Plus	£1579
H3000 3MB +D/Buffer	£1099		
H4000 4MB + Alpha +D/Buffer	£1279		
Genlock	£199		

OPAL VISION

24 bit board v2+ Opal Paint, Opal Presents, Opal Hotkey, Opal AminWATE

AS ABOVE, ALSO WITH IMAGINE SOFTWARE (Note- this version will only work with Opalvision) £649.99

IF YOU HAVE PURCHASED OPALVISION, YOU MAY HAVE RECEIVED VOUCHERS AGAINST THE FOLLOWING NEW PRODUCTS, WHICH WILL BE ACCEPTED BY HOBBYTE IN PART PAYMENT

Video Processor for Opal Vision WITH VOUCHERS	647.99
Video Suite for Opal Vision WITH VOUCHERS	647.99
Scan Rate Converter for OpalVision WITH VOUCHERS	647.99
Retina 24 Bit graphics card + 1MB +VD Paint	847.99
Retina 24 bit graphics card + 1MB + VD Point	339.00
Retina 24 bit graphics card + 2MB + VD Point	395.00
Retina 24 bit graphics card + 4MB + VD Point	489.00
V Lab 24 bit real time digitiser 1200/600/500 external	334.99
V lab 24 bit real time digitiser 1500/3000/4000 internal	289.99
V Lab 4000/3000 internal SVHS	334.99

FOR SPECIALIST ADVICE PHONE JP ON 0727 856005 SEE SOFTWARE BELOW

EMULATION

G Gate 386sx 25MHz	386.99	386 Bridgeboard	199.99
GVP 286 for GVPII +530	146.99	486 Bridgeboard	299.99
GVP 40/4 for 1500	945.99	Emplant	245.90
AT Once	214.99	Emplant Deluxe	339.90

SCANNERS & DIGITISERS

Epson GT 6500, 600dpi 24 bit A4 inc. Scan s/w	779.00
Epson GT 8000, 800dpi 24 bit A4 inc. Scan s/w	1129.00
Power Hand Scanner, 400 dpi, 64 Greyscale, Powerscan software	88.99
Power Hand Scanner as above, V3 for 1200/4000	104.99
OCR software for Power Scanner	48.50
Power Colour Hand Scanner	219.49
Sharp JX 100 A6 Scanner + scanlab s/w up to 18 bit	469.99
Summa Sketch II A4 with s/w/A3 Tablet Digitiser	359.99/529.99

SOFTWARE

GRAPHICS/CAD			
Aladin 4D	213.99	into smooth 25 frames/sec masterpieces. Also 24 bit Rotoscope video is frame accurately digitised, modified + re-recorded - inc deck controller h/ware	329.99
AmigaVision	17.90	Software only	189.99
Art Expression AGA	134.90		
Art Dept. Pro 2.3A	134.90		
AdPro Prof Conversion	48.99		
Brilliance	143.90		
Caligari 24	234.49		
Caligari Broadcast 3	396.90		
Cine Morph	29.99	Take 2	36.90
Deluxe Paint IV	53.99	TV Paint 24	679.00
Deluxe Paint AGA	62.99	TV Paint Junior	179.99
Disney Animation	56.90	Vista Pro 3	49.99
Distant Suns	49.49	Vista Makepath	24.99
Essence	44.50	X CAD 2000	89.50
Expert Draw	39.90	X CAD 3000	245.99
Gallery	39.49	VIDEO PROD/TITLING	
Image FX	179.99	A Video + TV Paint V2	588.90
Imagine v2	149.99	Adorage	48.50
Image Master AGA	139.90	AmigaVision	17.90
IntroCAD Plus	63.99	Broadcast Titler II	173.90
MORPHING		NEW-Broadcast Titler AGA	
Dazzle your friends with the effect-of-the-moment		Super High res	239.90
Morph +, top of the range package at £138.99, Cinemorph at £24.99 (RRP 49.99)		Broad T Font Enhancer	POA
Personal Paint AGA	44.95	Broad T Font Pack	POA
Pixel 3D Pro	119.95	Deluxe Photolab	51.49
ProDraw 3	99.99	imagemaster	159.99
ProDraw 4 AGA	POA	Montage 24 AGA -titling + graphics for Opal Vision and Impact Vision	POA
Real 3D Classic	78.90		
Real 3D v2	394.90		
Scala 500 HVT	64.49		
SPECIAL			
SCALA PRO 1.13	£99.99		
HOBBYTE PRICEWAS			
£173.50			
Scala MM200	274.99		
Sculpt Anim.4D	198.99		
Spectra Colour	57.99		
SYMPATICA II			
Do your animations slow down in real time? Still will turn them			
		SUMMER VIDI OFFER - Vidi Amiga 12 with Mogamix Master	£97.90

Vidi 12 Real Time	134.99
Vidi 24 Real Time	224.90

Video Timelapse VTL - creates stunning timelapse sequences - flowers opening, clouds, with sophisticated light/motion etc., record trigger inc. deck controller h/ware	329.90
Software only	189.99

EDUCATIONAL	
Any Fun School 3 or 4	15.99
Any ADI	16.99
Merlin's Maths	16.99
Paint & Create	16.99
Spelling Fair	16.99
See also software packs	
UTILITIES/LANGUAGES	
AMAX II Plus	249.99
Ami back	39.90
Ami back Tools	39.39
Amos 3D	21.49
Amos the Creator	30.95
Amos Compiler	19.49
Amos Prof	32.99
Amos Prof. Compiler	24.99
Easy Amos	22.49
Blitz Basic 2	54.95
CanDo 2.5	93.50
Gross Dos v5	29.75
CygnusEd Pro 3.5	69.75
Directory Opus 4	47.49
Disk Master II	43.75
GB Route +	32.99
GFA Basic	8.99
Gigamem	47.50
SAS/Lattice C	255.99
Quarter back	39.49
Quarter back Tools	43.99
Quarter back Tools Deluxe	59.99
True Print 24	47.90

Professional Page 4.1 AGA RATED as the current top DTP package by the independent magazines, 94% AF	119.49
--	---------------

SPECIAL THIS MONTH	
ProPage 4 and ProDraw 3 - professional illustrator's structured drawing package - Both for Only	£159.99
Protext 55	POA
Publisher	32.99
Saxon Publisher	177.95
Disk Master II	43.75
Superbase Personal 4	104.90
Superbase Pro 4	197.99
Typesmith	POA
Wordsworth AGA	72.90
Works Platinum	38.99

MUSIC	
AD 10 12 Studio 16 Sampler	349.95
Audio Engineer +2	149.49
Audio Master 4	41.49
Bars & Pipes 2	239.99
Clarity Sampler	104.99
Deluxe Music Const II	POA

GENLOCKS/MODEMS

Rendale 8802 (1200 compat)	139.99	Video Pilot v330	1094.94
Rendale 8802 FMC	159.95	Roegen+ 1200 compat	141.50
Rendale 8802 SVHS/8860	469.99	Roegen Rokey	189.90
Hama Genlock S290	689.99	Supra 2400 Modem	78.95
GVP G-Lock	289.00	Supra Fax Modem	148.90

SUPRA 2400+ FAX/MODEM

WITH 9600 FAX, 2400 DATA FAX SOFTWARE, ATALK 3 COMMS S/W, MODEM LEADS & POWER SUPPLY

£148.99

SUPRA 14440 FAX/MODEM

AS ABOVE, BUT UP TO 14,400 FAX/DATA

£279.00

ACCESSORIES & DISCS

A500/600/1200 printer centre	28.99	A520 Modulator	29.99
A500/1200 control centre	34.90	Alien/Batman/T2 Joystick	10.99
A600 control centre	27.90	Bug Joystick	11.99
Brickette CDTV Joystick adapt.	39.99	CDTV Keyboard	54.99
10 Blank DS/DD discs in box	4.99	50 Blank DS/DD discs	17.99
10 Blank DS/HD discs	6.99	50 Blank DS/HD discs	27.99

EXPANSION

A500 512k Rom Exp+Clock	21.99	A500+ 2MB, exp. to 8MB	149.99
A500+ 1MB exp	29.99	PC1204 4MB exp-dock	209.99

SPECIAL THIS MONTH

PC1204 4MB exp + 68882 25MHz	359.99		
CBM A600 1MB exp + clock	35.99	PC1204 4MB exp + 68882 50MHz	269.99
A600/1200 2MB exp (card)	137.99	MBX 1200 +68881 14MHz	119.99
A600/1200 4MB exp (card)	169.99	MBX 1200 4MB+68881 14MHz	278.90
CDTV 1MB exp + Super Agnus	157.99	MBX 1200 4MB+68882 25MHz	358.90
A500 Rom Sharer 1.3	37.95	MBX 1200 4MB+68882 50MHz	428.90
A500 Rom Sharer 2.04	38.95	2MB version MBX boards above subtract	£100
A600 Rom Sharer + 1.3	49.95	CBM 2.1 upgrade kit	74.99
		A2065 Ethernet Card	229.95

Chip fitting and board upgrade available, by our qualified engineers

POA

3YR WARRANTY WITH CITIZEN

PRINTERS

	ALONE	WITH STARTER PACK	ALONE	WITH STARTER PACK
Citizen 120+D	108.99			
Star LC20	116.99			
Citizen 90 mono	144.49			
Citizen 90 colour	159.49			
Star LC 100 9 pin col	149.99			
Star LC200 col	184.99			
Star LC 24-20 II	218.49			
Star LC 24-100 24 pin	173.49			
Star LC 24-200	209.99			
Panasonic KXP 2123 col	229.99			
Star LC 24-200 col	248.49			
Citizen 124D	176.99			
Epson LQ 100	179.99			
Epson LQ 570	259.90			
Epson LQ 870	469.90			
Epson LQ 1170	569.90			
Citizen S200 24"	184.99			
Citizen S240"	249.99			
Citizen S240C col"	269.99			
Citizen 240 and 240C with Pen Pal, RRP	£49.99			
Ends 30th September				
Epson Stylus 800	294.90			
Citizen S24x col"	325.90			

All HP Inkjets with 3yr RTB warranty

*Studio driver/Utility (WB 2 & above) highly recommended ADD £39.95

STARTER PACK: 500 Sheets A4 paper, Amiga to printer lead, Universal Printer Stand & Driver

*with Print Manager

NO DEPOSIT CREDIT AVAILABLE (subject to status), 29.8% APR, written details on application. All major debit cards accepted, no surcharges.

NOTE SEE WARNING TOP LH PAGE

ORDERING:

TELESALES NO: 0727 856005 FAX: 0727 834944

Some day despatch for debit or credit card orders placed before 5pm subject to availability. Alternatively send cheque, postal order, bankers draft or official order (PLCs, Education and Government bodies only) to: Dept. AF, Hobbyte Computer Centre, 10 Market Place, St. Albans, Herts AL3 5DG. Please allow 7 working days for cheque clearance. Subject to availability, despatch is normally within 24 hours of receipt of cleared payment. Prices are correct at time of going to press, however, we are sometimes forced to change them, either up or down. Please check before ordering. Additional services and different packages may be offered in our showrooms, and prices may vary from Mail Order prices. Personal callers are asked to quote this ad to ensure Mail Order packages are offered.

DELIVERY CHARGES: UK MAINLAND (NOT HIGHLANDS)

Small consumables & software items
Other items, except lasers
Offshore and Highlands
IN ADDITION WE OFFER THE FOLLOWING EXPRESS SERVICES:
Saturday deliveries
Am next day

Despatched by post, please check charges when ordering
Next day courier service, £10 per box
Please enquire

Normal rate plus £15
Normal rate plus £8

NO DEPOSIT CREDIT FACILITIES

Credit terms at 29.8% APR (variable) can be arranged for purchases over £150, subject to status. Competitive leasing schemes are also available for businesses, including sole traders and partnerships. Just telephone for written details and application form.

**CIVILIZATION
A1200**



PROGRAMMERS

MPS Labs

PUBLISHER

Kompart 0727 868005

PRICE

£39.99

RELEASE

Out now



95%

CIVILIZATION A1200

The world's best god game just got even better. Sam Meier's epic history of the human race is now available on the A1200 and looks set to wow you all over again.

Civilization enables you control the destiny of one of eight tribes who are locked in a bitter struggle for power. In the beginning you've only got brute force and the sheer will to survive on your side, but as you explore more and more of the world, you discover a whole range of scientific discoveries which enable you to leapfrog your opponents and gain the upper hand. The thing to remember, of course, is that your Amiga-controlled rivals are all trying to do the same to you.



Here come the new, improved, better-looking barbarians. It doesn't stop them terrorising the local populace and trying to nobble your cities though. Obviously manners maketh man, not good looks.

The great thing about *Civilization* first time around was its sheer addictability and ease of use – even if you had never played a god-game before you soon got the hang of it and were hooked for months. Not surprisingly, the A1200 version looks and plays even better with a beefed-up graphics palette and stereo sound samples. The overall look of the game has been changed in a subtle way – waves lap the shore on the map screens while the anima-

tions have become smoother and more detailed. The sound effects also help to boost the game's realism with strident martial music when you come under attack, or hammering sounds when you're building one of the world's Great Wonders. It all adds up to an electrifying and absorbing gameplaying experience.

Forget *Populous 2*, *Mega-lo-mania* and all those other pretenders to the crown, the A1200 version of *Civilization* sets the standard for all god-games. Superb.

Andy Nuttall

**WHALE'S
VOYAGE**



PROGRAMMERS

NEO Software

PUBLISHER

Flair 0836 327134

PRICE

£29.99

RELEASE

Out now



75%

WHALE'S VOYAGE

A1200

You've been left stranded and penniless in an ill-equipped spaceship above one of the most lawless planets in the solar system. You only have one choice – beam down to Castra or die.

Whale's Voyage is a space role-playing game (RPG) which places you in command of four adventurers

and their quest for wealth, fame and happiness. The action takes place in both 2D and 3D modes and bears more than a passing resemblance to more traditional RPG epics like *Dungeon Master* or *Eye of the Beholder 2*.

The original Amiga versions of *Whale's Voyage* looked great, but suffered from cumbersome joystick and keyboard controls – all too often you'd find yourself getting blasted to death by a gang of thugs while you were still trying to access the Combat

menu. Unfortunately, the enhanced A1200 version does nothing to rectify this and you're left with a few graphical enhancements and some atmospheric sound effects to spice up the gameplay.

Even if you do overlook the game's shortcomings you're still likely to be disappointed – there are only six planets for you to explore and *Whale's Voyage* lacks the depth and sense of involvement found in other space adventures like *BAT 2*.

Rob Mead

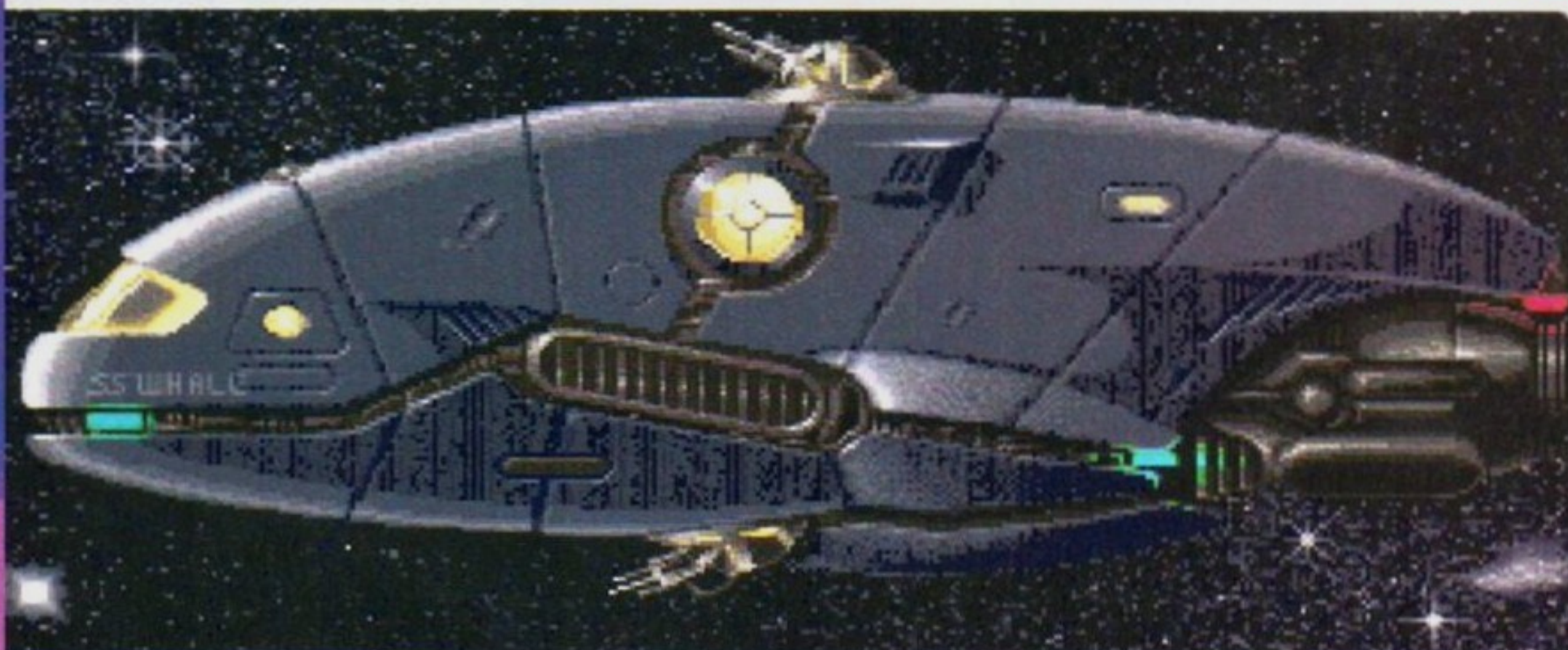

Your craft, the SS Whale – looking unbelievably whale-like – takes you all around the universe in search of a suitable planet to live happily ever after on.

1869 A1200/A4000

You can't beat the feeling of power money brings, and there's plenty of money to be made in the A1200 version of 1869.

It's the late 19th Century and the world is wracked with civil wars and international conflicts. In many ways, there's never been a more exciting time to launch a business venture.

You play the owner of a fledgling shipping company and you have to use your skills as a tactician and businessman to exploit the various trading situations around the world. If you succeed then your business expands, but if you fail, you could end up losing more than just your livelihood.

The A1200 version of this *Format Gold* winning game doesn't actually seem to be that much different from the original version – you get the same brief animation sequences and humorous interludes. You even listen to the same irritatingly nautical chip music.

However, 1869 can be best appreciated in multi-player mode with you and up to three other pals battling it out for ultimate control of the high seas.

Rob Mead

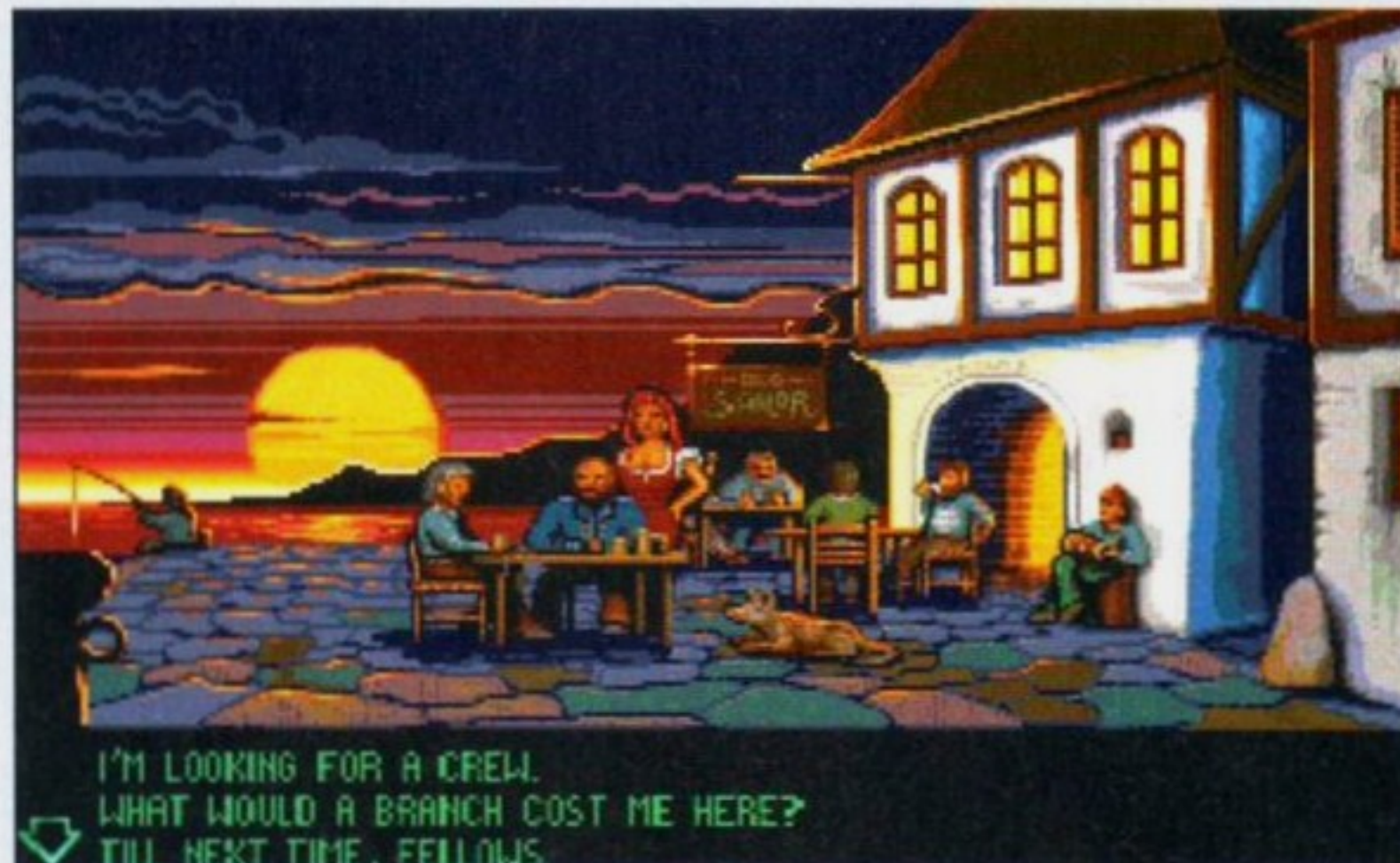

Another crowded night in the pub beckons. All good merchant traders know, however, that you should get straight in, press-gang a crew and get out again before you drink any grog.



The main map. From here you send textiles and machinery around the world, import exotic luxuries and slowly lose money.



He might look like Chairman Mao but this is your banker and he's not likely to say 'political power grows out of the barrel of a gun.'

1869 A1200/A4000



PROGRAMMERS

MAX Design

PUBLISHER

Flair 0836 327134

PRICE

£29.99

RELEASE

Out now



86%

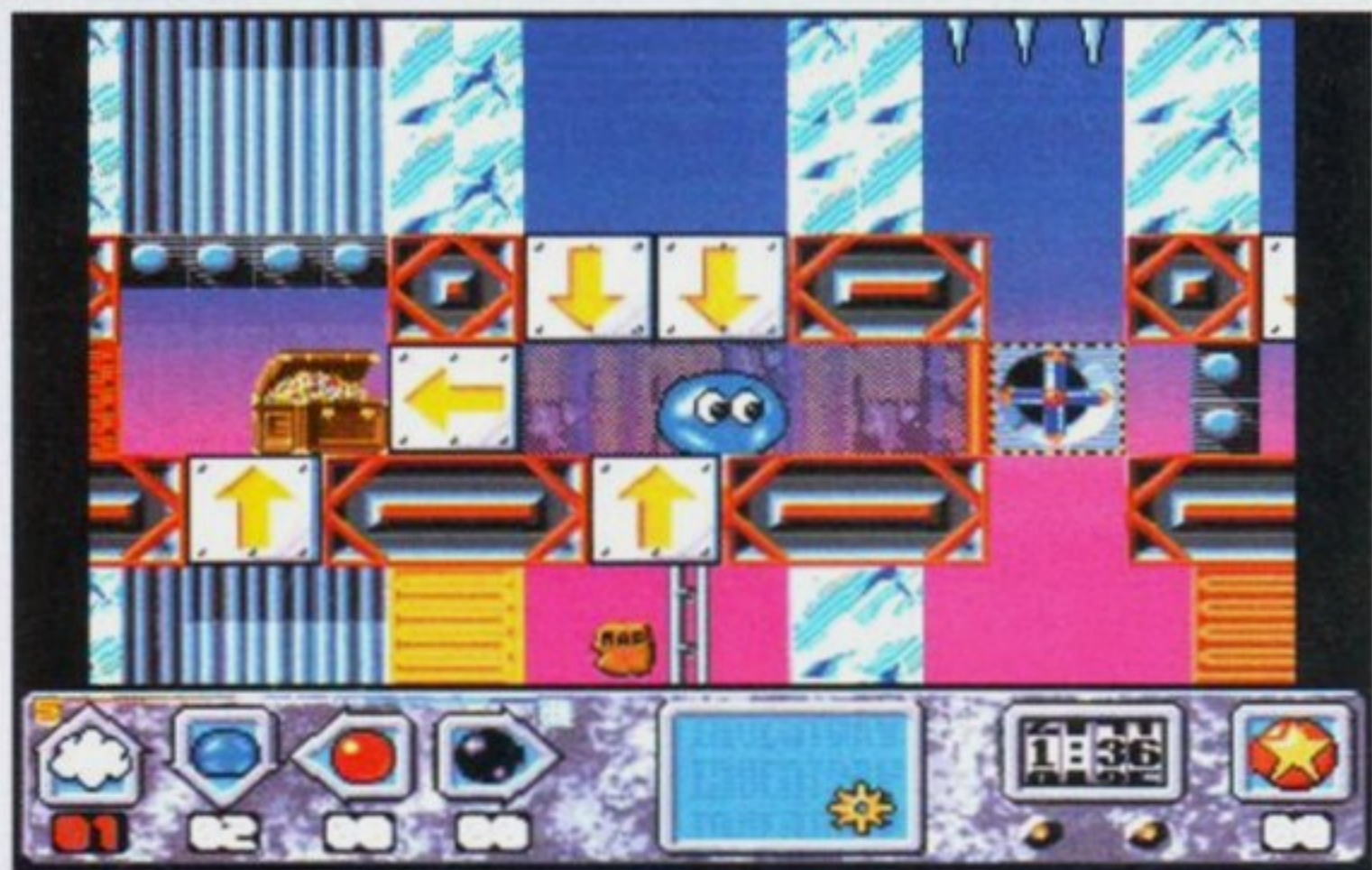

Before you say anything, yes, it does look like *Putty*. *Putty* was frantic, arcade-style, blood-pumping action, though, while *Morph* is more cerebral, thoughtful and serene.

MORPH AGA



The excellent feature of *Morph* is that you can visit any one of four levels first – so if you get stuck, move to a different level. Simple, eh?

And the subject of this week's platform game is... matter reorganisation. Eh, wait a minute – what's that all about, then? Well, the main character in Millennium's new AGA-only release is a blob, similar to the one from System 3's *Putty*. This blob has the excellent party trick-type ability to change (or morph, hence the name) into any one of four states: gas, liquid, rubber or solid.



With *Morph* you not only get to bounce around, but drift around like a, er, cloud of steam from a kettle. In a kitchen. Good grief.

Using this amazing ability, the idea is to make your way through 36 levels of puzzles and traps. Some traps will only snag you if you're in a particular state: for example, the spike will burst a rubber ball, and the extractor fan will suck any passing gas into oblivion. Sometimes it's necessary to fall through a grid, which is only possible for a liquid, whereas you need to be a gas to climb up a pipe. These puzzles and traps seem simple to negotiate, but given that you have a fixed number of 'morphs' things get more difficult.

Morph is expertly designed and programmed. The A1200 game has an extra 12 levels and 256-colour graphics throughout. The extra levels make the game more difficult, so Millennium have responded to complaints that the original was too easy. A1200 owners will relish it.

Andy Nuttall

MORPH AGA



PROGRAMMER

Peter Johnson

PUBLISHER

Millennium 0223 844894

PRICE

£29.99

RELEASE

Out now

85%

EUROPEAN CHAMPIONS

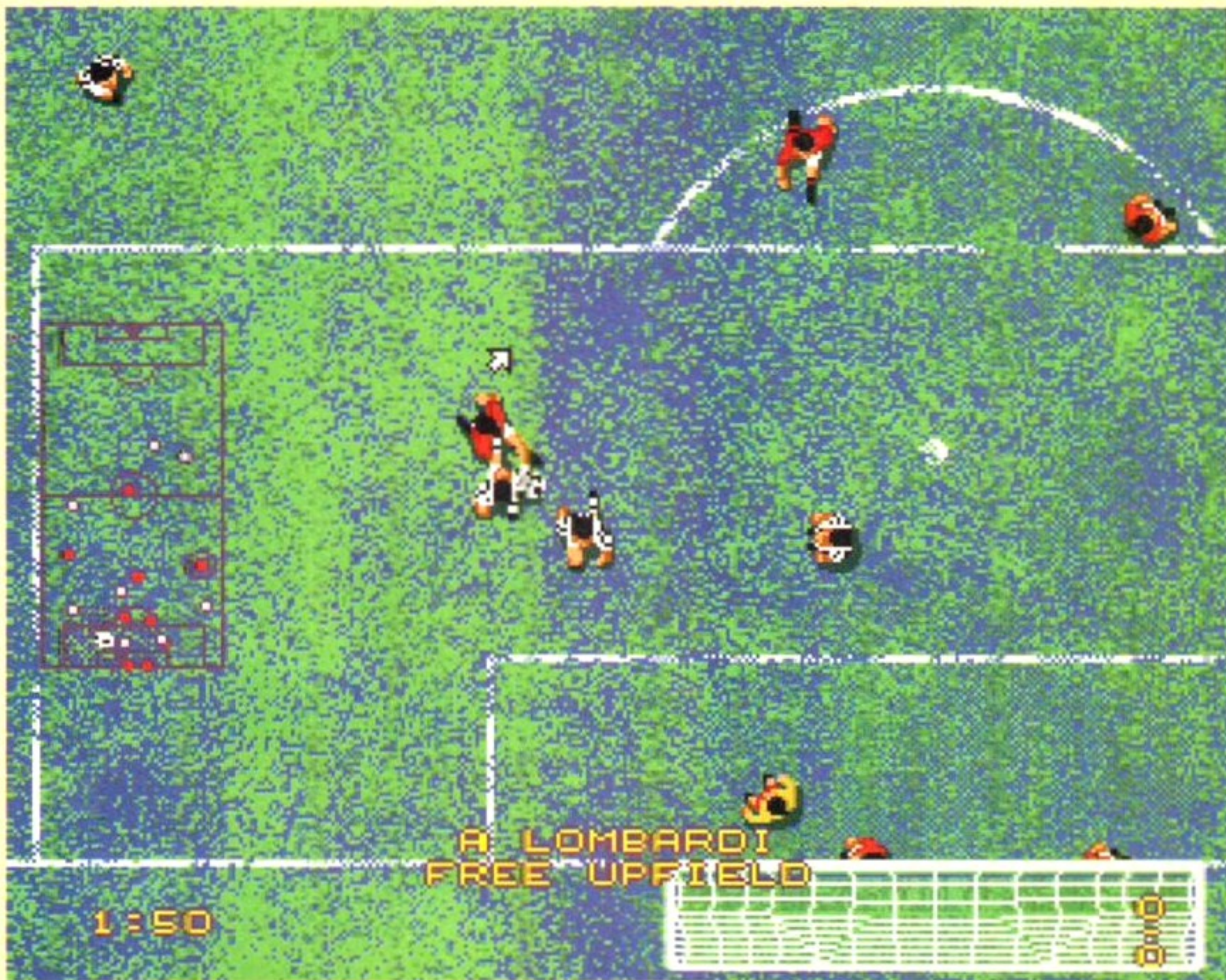

Nowadays soccer skills are not measured by how tenacious your tackles are, but the way you waggle your joystick. At the flick of a wrist you could be on your way to Wembley...

European Champions is at least attempting to be different. The sprites are bigger than Gordon Strachan, but when playing top-view down, they run in a very strange manner. And with a rather restricted view, it can get a bit confusing at times. The side view is similar in look to Manchester United Europe, but the play is far quicker. It's a matter of personal preference – the side view is my favourite in this game.

Get to grips with the game

Passing the ball should, in theory, be a simple exercise. Not so in *European Champions*. The manual does its level best to explain the options available but it's tough going. You can find yourself playing sweeping moves and scoring fantastic goals without really knowing what you did. OK, you pick it up gradually, but it's heavy going.

And I have other gripes. There are no black players, the scrolling occasionally falls behind play, and goals are sometimes awarded when the ball hasn't crossed the line. And the crowd sound like they are singing in a toilet. But the ref plays advantage (nice to see), you can commit barging fouls, and the goal celebrations are spectacular.

European Champions tries hard to please. It makes the right noises without quite hitting the mark. The number of times I've been bearing down on goal and attempted to shoot, only to see the ball passed out to the wing. Oh, it's my fault, but it's just a mite too confusing for my taste.

It's not a bad game. It's just that there are better football games available. Top marks for trying to do something different, but beaten by a goal in the dying minutes.

Stephen Bradley

Wet pitches. Who needs 'em? All that splashing around, a wet ball hitting you on the thigh at 50 miles per hour. Ouch! In this view of the pitch, the players run like sprinters, knees flying up to their shoulders. As you can see, the scanner on the left gives a clear indication of where Mr Lombardi is, I think.

When football was invented by Yorkshireman Albert Soccer in 1863, he couldn't possibly have imagined how popular it would become. And when Barnsley housewife Agnus Chippy unleashed the first computer on an unsuspecting public in 1950, she

could surely not have foreseen the demand for the 'football simulation'. Who can be bothered playing real football these days when you can sit at home and pretend to be Ryan Giggs? And it's no wonder the national team are struggling when John Barnes plays all his matches at home on his Amiga (allegedly).

Step forward *European Champions*, the latest option-packed contender. Select the strength of the wind, have a lenient referee, use the video replay system, play sideways or top down, use manual

Time for a change

radar mode, select PingPass or PointPass, play for 90 minutes on astroturf, on skill level 10 – and then have a game of football. It's as simple as that, really. But are these the options we want? No. It's time for something different. What about a Football Style game, where you shape a footballer's look, right down to his haircut? Marks could be awarded by Football Taste Police (or your Amiga). For instance, a BMW driving, bubble-permed Cockney with a four-bedroom semi in Hemel Hempstead would be awarded, say, five out of 10. But give him an E-type Jag, a bob and a two-bedroom townhouse in Fulham and the mark could shoot up to seven. Add to that cowboy boots and an affair with a 'supermodel' and you're staring down the barrel of a nine. Then you get to play in the Cup Final. However, I digress.



Tactical awareness. Do you play the long ball, pass to feet or use a zonal strategy? I just keep on pressing that firebutton – it nearly always works for me.



You join us in an incident-packed first half. Leeds and Arsenal players have joined together in a wonderful performance of the Floral Dance.



One player has finally got hold of a football. Someone called E. Cantona appears to be free upfield. I don't think I've heard of him before.

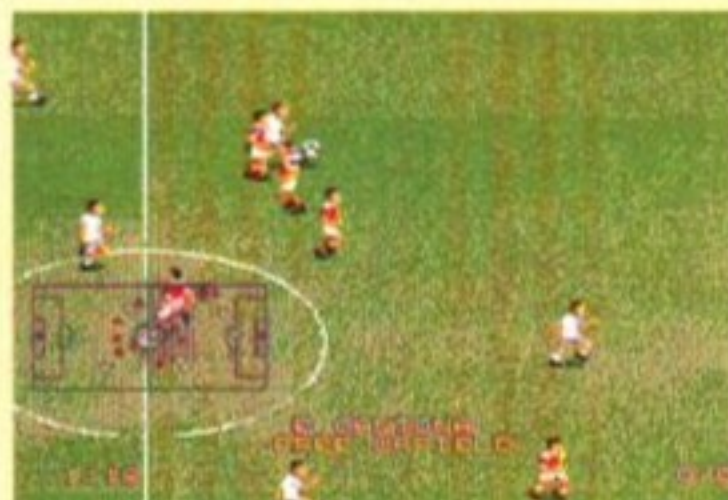

The scanner politely informs us that the midfield is somewhat congested. Hurry up, that E. Cantona chap isn't going to be free forever.

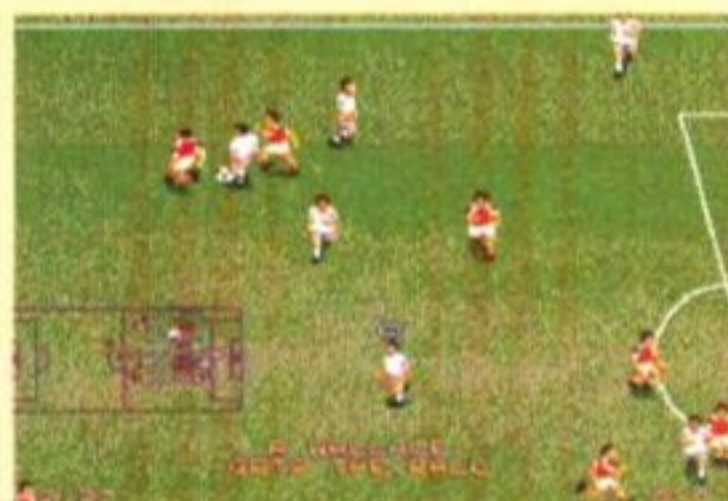

Meanwhile Wallace winds his way up the pitch and takes possession of the ball, marked by a Roger Moore Saint-like hovering white halo.



As halo turns to an arrow, Wallace is urged to shoot at the goal. Around him players scamper in different directions, scared of the consequences.



But Seaman saves it and the score stays at 0-0. Now it's number nine's turn to show Seaman it was just luck, not skill that saved the day.

EUROPEAN CHAMPIONS



PROGRAMMERS

Graham Blighe, Herman Serrano, Richard Beston

PUBLISHER

Ocean 061-832 6633

PRICE

£25.99

RELEASE

Out now



GRAPHICS



Like real little men, almost.

SOUND



Songs from the big cubicle.

ADDICTION



Fun when using the side view.

PLAYABILITY



Gameplay too fiddly.

VERDICT

“ A skilful game which scores well in most areas, but still doesn't quite match the mark of the more playable football sims which are already out there.”

73%

NO TRICKS JUST TREATS

A small selection from the vast range of titles we stock. Phone for a complete price list containing over 600 titles.



eu
european
computer user

**FREEPHONE
0800 318576**

Fax: 0480 496379

TITLE	PRICE
1869 (A1200)	19.99
+4D SPORTS BOXING	8.99
+ABANDONED PLACES 2	20.99
+AGONY	10.99
ALIEN BREED 92	8.99
AMOS PRO	23.99
AMOS PRO COMPILER	23.99
+ANOTHER WORLD	16.99
+APOCALYPSE	16.99
+AQUATIC GAMES	10.99
ARABIAN KNIGHTS	15.99
+ASHES OF EMPIRE	8.99
+ASSASIN	15.99
• ATAC	23.99
A-TRAIN	23.99
• A-TRAIN CONS KIT	10.99
+AV88 HARRIER ASSAULT	19.99
+BARBARIAN 2	10.99
BAT 2	21.99
BATTLE ISLE 93	15.99
+BATTLE ISLE	15.99
+BATTLE ISLE DATA DISK	10.99
BILLS TOMATO GAME	10.99
BLADE OF DESTINY	27.99
BLASTAR	16.99
BLOB	16.99
BODY BLOWS	16.99
+BOSTON BOMB CLUB	4.99
BURNIN RUBBER	16.99
CAMPAIGN MISSION DISK	11.99
+CAPTIVE	10.99
• CASTLES 2 (A1200)	23.99
+CENTREFOLD SQUARES	6.99
CHAMPIONSHIP MANAGER93	16.99
CHAOS ENGINE	16.99
+CHUCK ROCK	8.99
+CHUCK ROCK 2	15.99
CIVILIZATION	23.99
• COMBAT CLASSICS 2	19.99
• COMBAT AIR PATROL	19.99
+COOL WORLD	9.99
CREATURES	15.99
+CURSE OF ENCHANTIA	15.99
• CYBERSPACE	23.99
+DALEK ATTACK	11.99
DARKSEED	19.99
DESERT STRIKE	20.99
• DIGGERS	17.99
• DOGFIGHT	23.99
+DOUBLE DRAGON 3	5.99
+DRAGONS BREATH	7.99
DUNE 2	19.99
EUROPEAN CHAMPIONS	16.99

TITLE	PRICE
F17 CHALLENGE	9.99
F19 STEALTH FIGHTER	11.99
FLASHBACK	21.99
+FORMULA ONE GRAND PRIX	17.99
GOAL(1MEG)	19.99
GRAHAM GOOCH CRICKET	19.99
+GLOBAL EFFECT	12.99
GLOBAL GLADIATORS	16.99
GUNSHIP 2000	23.99
HARD DRIVIN 2	7.99
• HERO QUEST 2	16.99
HILL STREET BLUES	7.99
• HIRED GUNS	19.99
+HISTORYLINE	21.99
HUMAN RACE JURASSIC LEVELS	16.99
+HUMANS DOUBLE PACK	24.99
INDY JONES FATE OF ATLANTIS	25.50
+ISHAR-LEGEND OF FORTRESS	10.99
ISHAR 2	19.99
+JAGUAR XJ220	9.99
+JIMMY WHITES SNOOKER	10.99
+KID GLOVES 2	10.99
+KNIGHTMARE	10.99
KNIGHTS OF THE SKY	12.99
LEMMINGS 2	17.99
+LETHAL WEAPON 3	9.99
LINKS-THE CHALLENGE	12.99
LOOM	10.99
• LORD OF THE RINGS 2	19.99
+LOTUS THE FINAL CHALLENGE	13.99
• MAGIC BOY	16.99
MANIAC MANSIONS	9.99
• MAN UTD PREMIER LEAGUE CHAMP	19.99
+METAL MUTANT	4.99
+MONKEY ISLAND 1	13.99
MONKEY ISLAND 2	25.50
MORPH	15.99
• NICKY 2	16.99
NIPPON SAFES INC.	19.99
• NODDY'S BIG ADVENTURE	16.99
NO SECOND PRIZE	15.99
OH NO! MORE LEMMINGS	10.99
OMAR SHARIF'S BRIDGE	20.99
ONE STEP BEYOND	14.99
• OVERDRIVE	16.99
+PERFECT GENERAL	21.99
+PERFECT GENERAL DATA DISK	14.99
PINBALL FANTASIES	17.99
PIRATES	9.99
+PREMIER MANAGER	13.99
• PRIME MOVER	19.99
PROJECT X	9.99
+PUTTY	9.99

TITLE	PRICE
• QUAK	8.99
RAGNAROK	23.99
+RAILROAD TYCOON	17.99
+RAVING MAD	9.99
REACH FOR THE SKIES	19.99
ROBOCOD	10.99
ROBOCOD A1200	15.99
+ROME AD 92	15.99
SABRE TEAM	15.99
SCRABBLE	17.99
SENSIBLE SOCCER 92/93	16.99
SHADOWWORLDS	15.99
+SILENT SERVICE 2	17.99
SIM CITY DELUXE	25.99
SIM LIFE (A1200)	23.99
SLEEPWALKER	14.99
SOCCER KID	17.99
• SPACE HULK	23.99
SPACE LEGENDS	20.99
• STAR TREK-NEXT GENERATION	23.99
+STORM MASTER	6.99
SUPER SPACE INVADERS	7.99
SYNDICATE	23.99
TECHNO SOUND TURBO 2	32.99
THE ADVENTURES OF ROBIN HOOD	9.99
THE GREATEST	19.99
+THEIR FINEST HOUR	15.99
THE PATRICIAN	21.99
THE RYDER CUP (1200)	16.99
+TITUS THE FOX	9.99
+TRODDLERS	10.99
• UNIVERSAL MONSTERS	16.99
WALKER	19.99
WHALE'S VOYAGE	19.99
• WINTER CHALLENGE	23.99
WONDERDOG	16.99
WOODY'S WORLD	16.99
WORLDS OF LEGEND	16.99
+WWF 2	9.99
YO!JOE!	16.99
+ZOO!	14.99
JOYSTICKS	
CHEETAH BUG	10.99
COMPETITION PRO	11.99
CRUISER (BLACK)	8.99
FOOTPEDAL	18.99
MAVERICK	10.99
MINDSCAPE POWERPLAYERS	5.99
NAVIGATOR	11.99
QUICKSHOT APACHE	5.99
QUICKSHOT PYTHON	8.99
SPEEDKING (AUTO)	8.99
ZIPSTICK	10.99

All items are subject to availability.

Prices can be subject to change. E&OE.

Post and packing: UK = 75p per item 2nd Class; £1.50 per item 1st Class; £2.00 per item 1st Class Recorded.

E.E.C. = £3.00 per item; Non-E.E.C. = £6.00 per item;

Swift Air E.E.C. = £5.75 per item; Swift Air Non E.E.C. = £9.00 per item

Next Day Courier = £5.00 per consignment (Up to 5kg. Deliveries Mon-Fri Only)



Titles marked with a * may not be released at time of going to press. Please

telephone for availability and a full copy of our terms and conditions.

Titles marked with a + are available at the price shown while stocks last.



OPEN ALL DAY SATURDAY

NAME

ADDRESS

POSTCODE PHONE

ITEM

ITEM

ITEM

(Please indicate if you require Disk or CD-ROM)

Visa/Mastercard/Switch Number:

Switch issue No: Card Expiry Date:

PRICE

PRICE

PRICE

POSTAGE

TOTAL

Make cheques payable to:
European Computer User
& send to:
Units A2/A3 Edison Rd,
St Ives Huntingdon

AMIGA GET

We've been getting a bit bored of single-disk issues on old tat on another one for the sake of it. But then, as

TWO COV

But not just any old two coverdisks. Disk One will be very best from the world of PD, certainly, but Disk

Jon Hare, Orchestrating Director, Sensible Software:

"We're going to take AMIGA POWER readers back in time, to an age when *Cannon Fodder* was young. We're going to give you not just one demo of it, but a whole series of demos which chart the game's progress over the last few months, so that you can see the game forming and growing in front of your very



You heard him. It's the world's first Interactive Diary Of A Game, £3.95 ready and start queueing down at your local newsagents (The issue, that is, not the newsagents.)

THURSDAY OCTOBER 14.

THIS!

AMIGA POWER, but we didn't want to just shove any luck would have it, something special came along...

ERDISKS!

full of our usual blend of top-notch demos and the Two, well, let's hear it from the horse's mouth...

eyes, as if you were actually *in* top software house Sensible Software, like we are! You'll be able to play the same game several times, but at different stages in its development, a bit like you were in a time machine! And not only that, but there'll be a few special little unavailable-in-the-shops extra things on the disk too, but you'll just have to wait and see about those..."



and it's exclusive to the November issue of AMIGA POWER. Get now. It's closer than you think.

AMIGA POWER

The world's least tedious Amiga games magazine.



Who says Final Copy II is the Best Word Publishing Program?

Not *just* thousands of satisfied Amiga owners, but Amiga Format too!

We call it a Word Processor, but if both experts and satisfied users alike insist on calling *Final Copy II* a 'Word Publisher' [once they have discovered its unique blend of powerful features], we're not about to argue with them.

Final Copy coined the phrase "Perfect Printing" on any printer, and we mean it... the document shown below proves it! We hope you too will find that *Final Copy II* is Perfect for your printing!

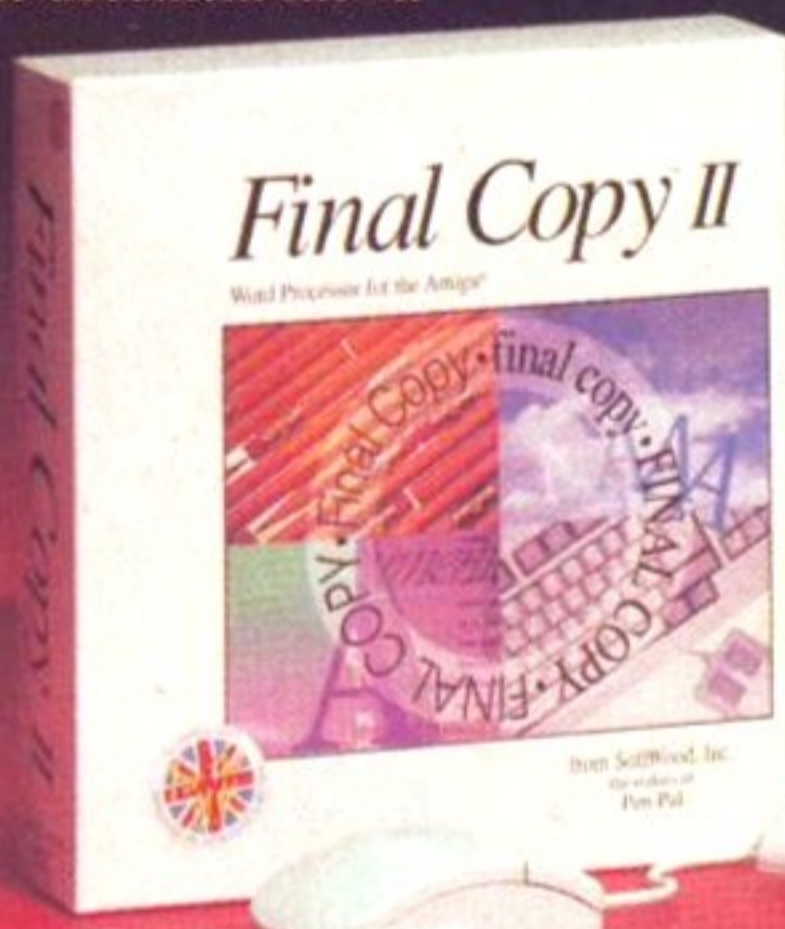

Please look for a UK logo on the box as your guarantee of technical support and future upgrade offers. British-English, French and German versions available worldwide.



Final Copy II

£99.95 or less
Release 2.0 (AGA)

Word Publishers go beyond simply producing normal letters and documents (at which *Final Copy II* naturally excels) and progress into a world where how the whole document looks is just as important as what it says. Admittedly, this can be achieved with Desk Top Publishers, but they can't easily be used as Word Processors, especially when a good looking letter needs creating quickly - they're far too cumbersome. This is where *Final Copy II* offers the perfect balance between the two requirements. Ease and speed of use, combined with complete control and perfect final printed presentation. **Complete control over how documents look, now YOU have it at your finger tips on your Amiga!**

Features include:
On-Screen Drawing Tools for generating boxes, borders, and lines or arrows at any angle, Multiple Newspaper Style snaking columns, combined with the unique ability to use the same PostScript outline fonts - on absolutely any printer in portrait or landscape. Text Auto-Flows around graphic objects and imported pictures, which can be placed anywhere, scaled and cropped, with no loss of printing quality. Text can also be printed actually over graphics (refer to "The Tiger" heading on our document). All these features mean that no matter what you may have thought, no other Amiga Word Processor has all the capabilities that *Final Copy II* users now simply take for granted!

We don't have room to list EVERY feature that *Final Copy II* can boast, so please call for your free DETAILED information pack now.

SoftWood - Quality software for your Amiga

With *Final Copy II* you're not just getting a one off product! SoftWood are acknowledged as the World's leading software company who develop for the Amiga, and no other system. Once you're a registered SoftWood product owner, you'll be gaining access to unlimited free technical support (others charge), and preferential upgrades to new versions of this and other exciting products being developed right now!

Compatible with all Amigas from A500 to latest A1200/A4000 ranges with either second floppy or hard drive. Minimum 1Mb. available free RAM required (A600 hard drive - 1.5Mb). As with all advanced graphical programs, extra memory (eg. 1.5/2Mb. - more the better) is required to exploit all features.

Available from all good Amiga Software Dealers,
or contact your nearest SoftWood Agent for a list of stockists in your country....

 SoftWood Products Europe - UK
PO Box 19 Alfreton Derbyshire DE55 7BP
Tel: 0773 836781 Fax: 0773 831040

 VEM (Essonne Mailing) - France
14 rue de Bois Sauvage 91055 EVRY Cedex
Tel: (1) 64.97.96.54 Fax: (1) 69.91.19.25

 TupSoft - Australia/New Zealand
9 Miller Avenue Hornsby NSW 2077
Tel: (02) 477 5353 Fax: (02) 476 5736

 Amiga Oberland - Germany
In der Schneithohl 5 W-6242 Kronberg 2 Frankfurt
Tel: 06173 65001 Fax: 06173 63385

Please rush my personal copy of the detailed Final Copy II information pack, including samples from popular printers, and a list of stockists to... (clip the coupon or call 0773 836781 now!)

Name & Address:

amf

"But when the blast of war blows in our ears, then imitate the action of the tiger." Or you could sit down at your Amiga, boot up UMS and forget to feed the cat...

P hew, what a package! Five manuals and 12 disks covering all the various UMS releases: the original and frankly rather dated *Universal Military Simulator* itself, plus sequel and upgrades *UMSII: Nations at War*, *UMSII: Planet Editor* and the *UMSII Civil War Scenarios*.

The first thing that strikes you about the package is that it's all rather disorganised. If the developers had bothered to re-write the manuals and repackage the software life would have been a lot easier.

An example. There are no instructions on installing the first UMS on hard disk. To install *UMSII* there are Shell commands for you to type in (which are wrong, incidentally; the command path `udisk:` should have `add` after it) and to install *UMSII: Planet Editor* you must use icons. Consistency would be good.

It's also rather wearing to plough through five manuals, covering over 600 pages, and five installation procedures when one of each would have done. However, you do get a lot for your money at around half the price you'd have had to pay for the complete set. Shame it's all slapped together rather than lovingly crafted.

UMS, huh!

What is it good for? Well, quite a lot actually. The package breaks down into two definite sections - *UMS* and *UMS II*. Both offer a lot of possibilities. The surprisingly aged *UMS* itself is still a damn good skirmish controller. Over a small playing field you can recreate any two-sided conflict, although it can be frustratingly

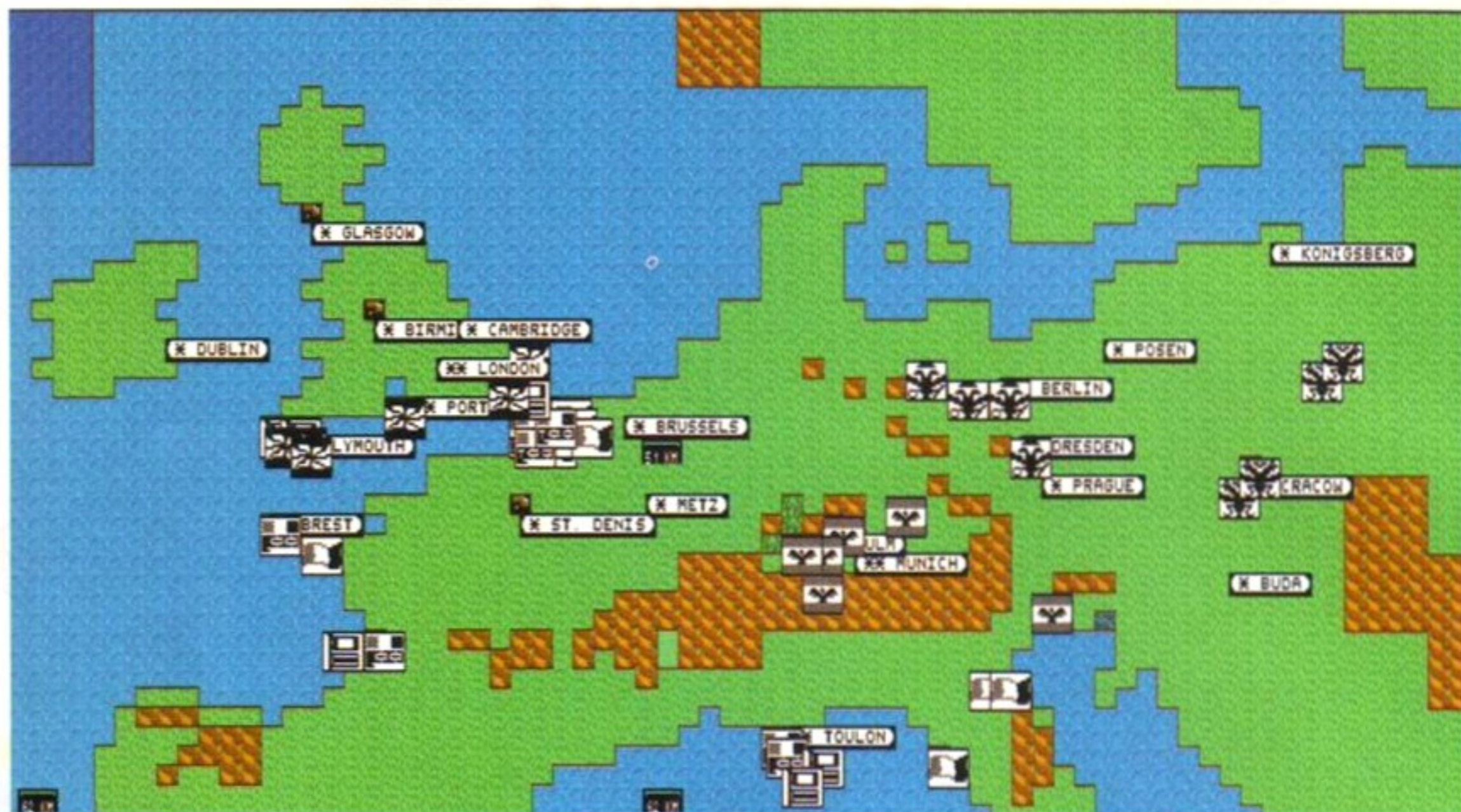

The Napoleonic years. This is one of four levels of display (five if you count the largely useless globe option, where you see one side of the whole planet). At this level of detail only the major armies are shown. Which is just as well because when you get down closer it can get a mite confusing.

UNIVERSAL MILITARY SIMULATOR

THE COMPLETE COMPILATION PACK

slow at times. Once you get into the heat of battle, despite some rather cheesy samples emanating from your speaker, you do get involved.

The options are excellent, letting you view the battle from any angle and zoom in and out as you wish. You can even switch sides half-way through a battle if you don't like the way it's going. You can play against the computer, letting it choose its own tactics, or you can force it to attack you through the middle, try to out-flank you, defend and so on.

UMSII is a different thing altogether. You have an entire world as your playing area, with multiple opponents and allies, all of whom have artificial intelligence (of a sort) that you can manipulate. There are very powerful display options which let you zoom from viewing the globe into an area of a few hundred square miles and colour graphics!

Like *UMS*, *UMSII* can be very slow at times. If you play the Desert Storm scenario it takes several minutes for all the computer-controlled

nations to make their moves, and that's on an A1200. On the plus side, the moves that are finally made are rational and within the parameters set by the Artificial Intelligence options. Rome wasn't built in a day, nor did it fall in one.

Design-a-planet

One of the highlights of *UMSII* is the Planet Editor. You can create all kinds of terrain features, place cities and towns, designate nations and alliances and then, of course, force



When you make your own planets, you too can have Arctic wastes within a few miles of desert. Think it's time to add a swamp or two.

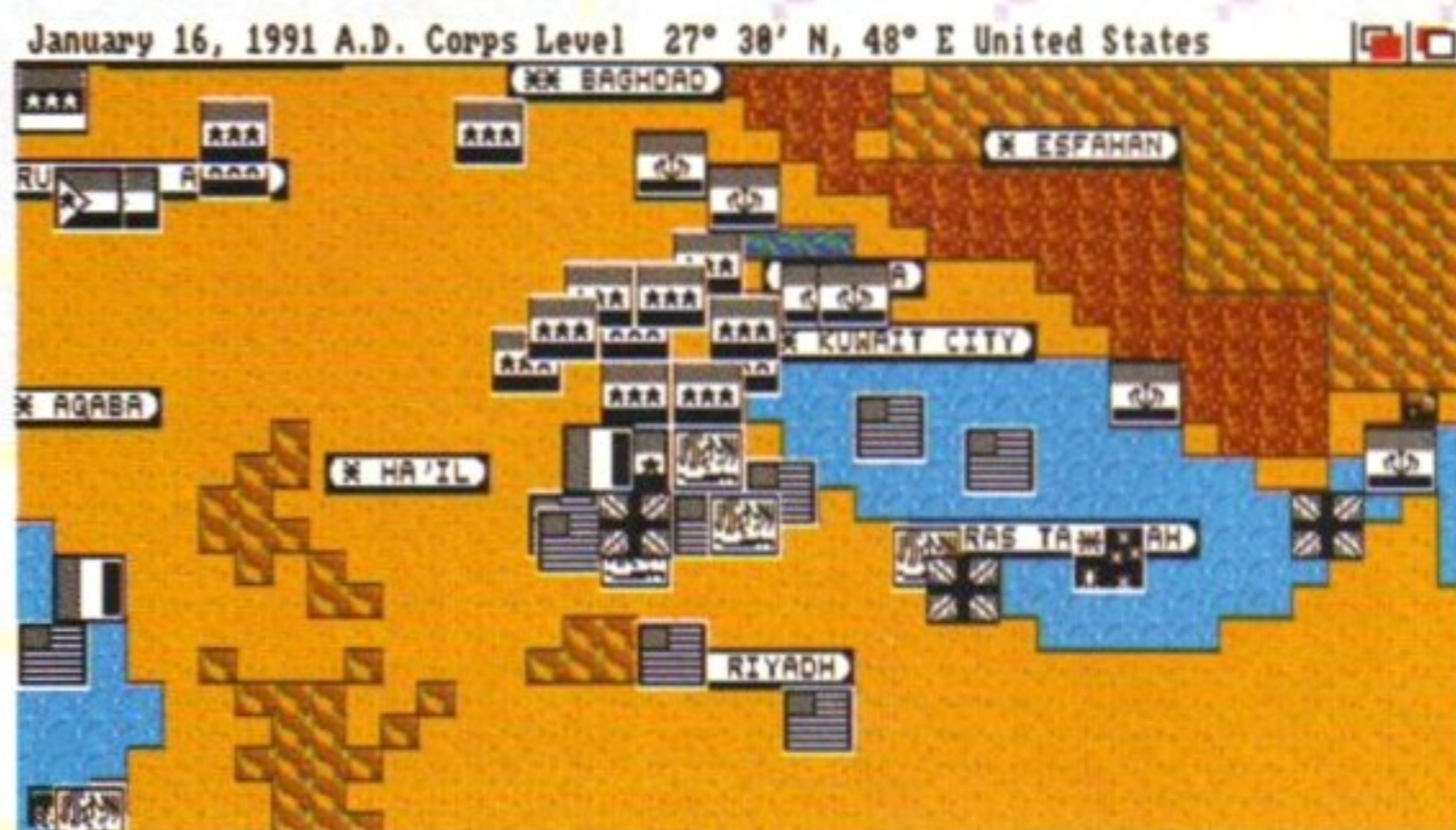

I reckon Saddam's going to come under a bit of pressure later on in the game. Still, his men look quite strong at the moment.

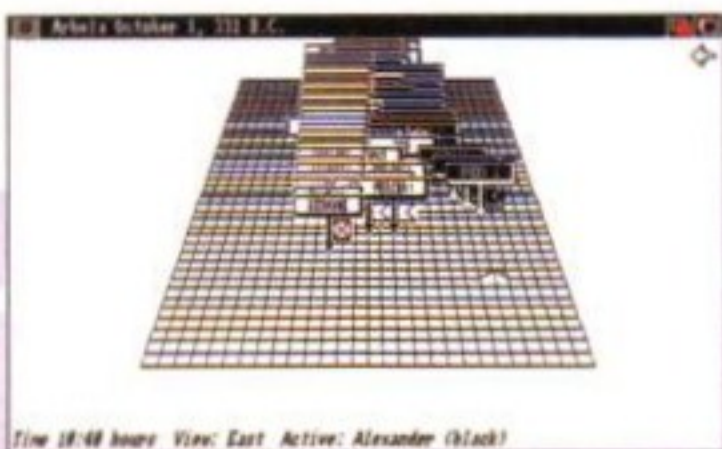

Alexander vs Darius at Kick-off. Graphics like this bring a nostalgic tear to the eye, don't they?

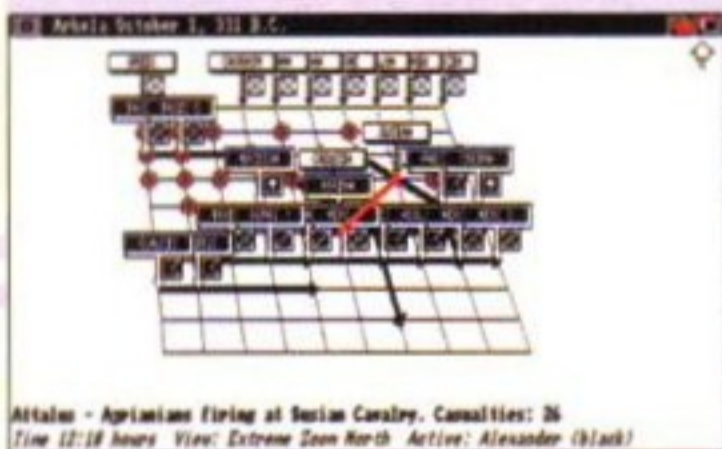

Now they're getting stuck in. Those Greek lads look a bit handy.

them all to kill each other. It's all very healthy and natural, even spiritually rejuvenating. God must be laughing.

Flawed genius?

UMS suffers from a greatness that is also its fundamental flaw: its versatility. With UMS you can recreate any conflict from any age. Indeed, there are several scenarios provided with the game ranging from Alexander the Great, through the Napoleonic wars to Desert Storm.

As well as the provided scenarios, you can create your own. With the editing facilities you can roughly recreate any type of military unit from a dragon to an anti-grav sled-mounted thermonuclear Gauss Cannon. The problem is that you might well end up giving these two vastly different entities pretty much the same statistical values, with the only difference being their name.

UMS is likely to lose out on atmosphere in the long run, for this very reason - there is little difference in the feel of the game whatever epoch you are playing. A Roman road looks much the same as a 12-lane highway.

A game like *Campaign*, which is much richer in atmosphere, cannot compete with the long term appeal of UMS. It does, however, make use of the Amiga's tremendous graphics potential in a way that makes UMS look like it isn't trying. The UMS control system is cumbersome too, relying almost entirely on pull-down menus instead of point-and-click.

In all, UMS is a must for the serious war gamer. If spending Saturday afternoons in draughty village halls shuffling thousands of tiny little men around a big polystyrene-and-rubber playing field is your idea of a good time then UMS was made for you. But it is serious stuff, and therefore not recommended to more frivolous gamers after a quick thrill.

Richard Jones

UMS COLLECTION



PROGRAMMERS
Intergalactic Development Inc.

PUBLISHER
Mirage 0260 299909

PRICE
£44.99

RELEASE
Early October



**HARD DISK
INSTALLABLE**

GRAPHICS
Functional, but unattractive.

SOUND
Really rather weak.

ADDICTION
Will keep you interested.

PLAYABILITY
Complex, but user-friendly.

VERDICT

“ A package that gives you a lot for your money, even though it is thrown-together. Only for serious war-gamers. ”

74%

"IT IS WITHOUT DOUBT THE MOST POWERFUL CAD PACKAGE FOR THE AMIGA BAR NONE. NO OTHER PACKAGE COMES CLOSE"

AMIGA FORMAT

XCad

SPEED - An Amiga 1200 is 12 times faster on zoom and redraw than AutoCAD running on a fast '386.

PRACTICALITY - Ideal for design in architecture, electronic and/or mechanical engineering.

COMPATIBILITY - AutoCAD DXF import/export comes complete across the XCad range. Print to plotters, laser or dot-matrix printers.

MODULAR - Simple upgrade from XCad 2000 to XCad 3000 and PC/UNIX versions.

Imagine

The 24 bit image below was completely originated on an Amiga computer. The drawings were designed with XCad, the 3D model was created from the 2D drawings and the 24 bit image (1280 x 1024 resolution) was rendered with Imagine! Compare this to AutoCAD, and 3D Studio which will cost £4550 - and that's just for the software!

Never before has the Amiga been so well complemented. Never before has the Designer been given so much power, speed and flexibility at such an affordable price.



The above building was designed by Architect David Bishop, modelled by XCad and rendered with Imagine.

XCad harnesses the incredible power of the Amiga to deliver a draughting tool to beat all others. Processing times are cut to a fraction of most PC based systems. Plans, designs and blueprints can easily be produced using simple, flexible menus or commands.

The XCad range starts from as little as £79* for XCad 2000 (1Mb FAST RAM minimum) which includes both 2D Detailing and 3D Modeling plus automatic perspective views.

To order the Amiga's No. 1 CAD package, contact your local dealer or call:

HOBBYTE COMPUTING
Tel: (0727) 856005

DIGITAL MULTIMEDIA LTD
Tel: (081) 977 1105

* Christmas Special Promotion, price reduced from £129 to £79 for full 3D XCad 2000 - while stocks last.

All trademarks acknowledged

WIN!

40 analogue joystick interfaces up for grabs

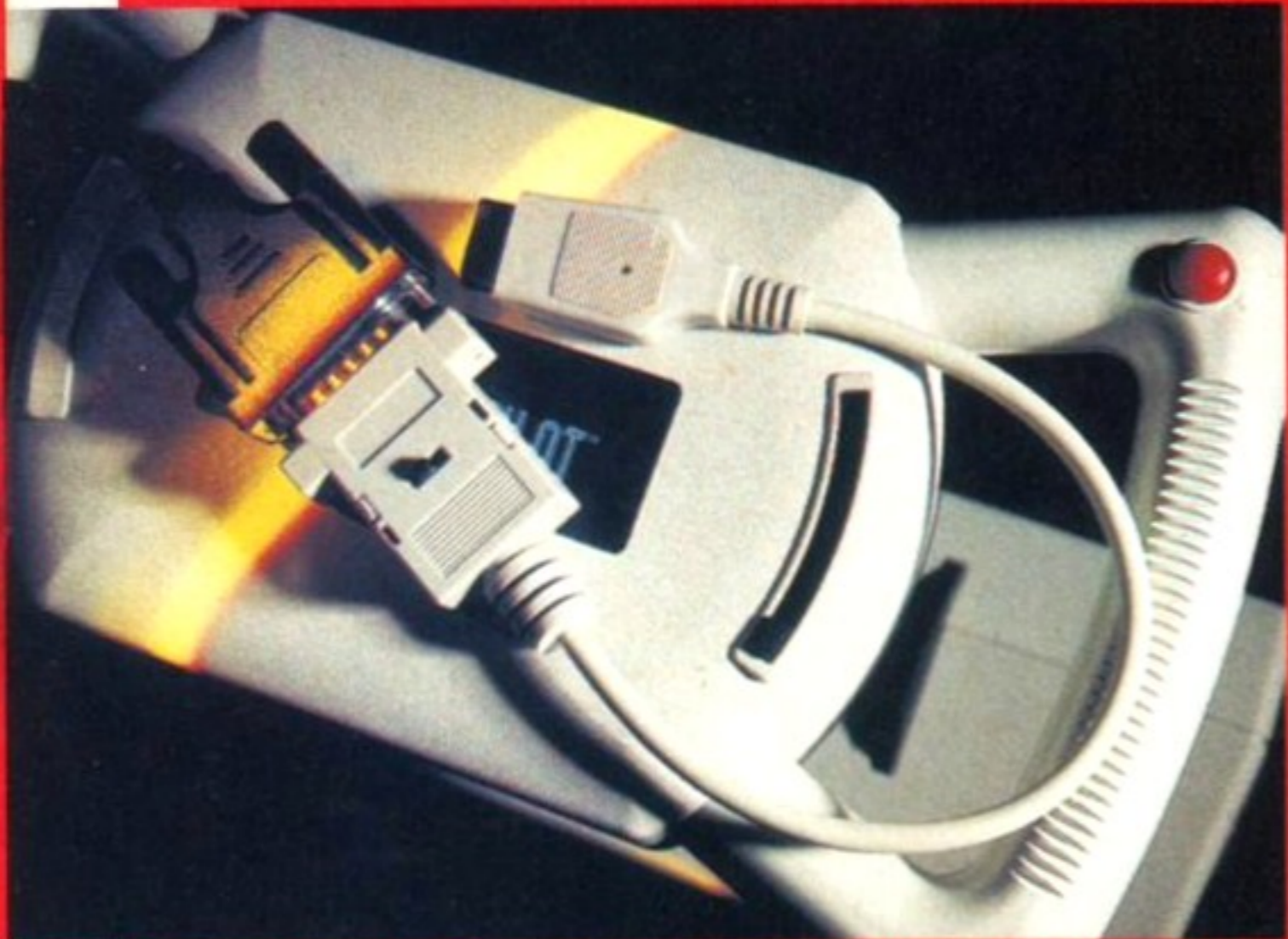

With a Digiprint interface, you can use a smart IBM PC joystick like this: it not only looks and feels the part, but it also gives your plane realistic response and feel.

Flight sim freaks – ultimate control is within your power! For ultra sensitivity in manipulating your aircraft through the toughest of missions, an analogue joystick is a must. Sadly for the Amiga decent ones are rare. For the PC, however, there are plenty to choose from, and this is where this excellent interface from Digiprint comes in.

Available from Lightwave for £14.99, the DP IBM analogue interface (reviewed AF49, 80%) is a short grey cable with a standard Amiga 9-pin plug on one end, and a 15-pin socket where the IBM joystick plugs in, and it makes flight sims far easier to control.

There's a huge range of games that support analogue on the Amiga including *Birds of Prey*, *A-10 Tank Killer v1.5*, *F15 Strike Eagle II*, *Flight of the Intruder*, *Knights of the Sky*, *Red Baron*, *Flight Simulator II*, *Dog Fight* (out soon), *MiG 29*, *MiG 29 Super Fulcrum*, *F-19 Stealth Fighter*, *Air Warrior*, *Gunship 2000*, *Jumpjet*, *Nova Nine*, *Formula One Grand Prix*, *Ancient Art of War in the Sky*, *Tornado* (out soon), *Reach for the Sky*, *A320 Airbus*, *F16 Combat Pilot* and *Mansell's World Championship!*

Well, if that huge list of games isn't enough for you to get excited about, then we don't know what is. Now for what you have to do to get your hands on an analog interface is answer the following questions.

- a) Which hi-tech Russian fighter plane crashed recently in an airshow in Britain?
- b) Which World War II flight simulator won an AF Gold in Issue 48?
- c) How many pins are there in an IBM joystick socket?

Send your entries on a postcard, or sealed envelope to: Flying High Comp, Amiga Format, Future Publishing, 30 Monmouth Street, Bath BA1 2BW. Usual rules apply.

THE RULES: No employee of Future Publishing, Digiprint or Lightwave can enter this competition.

CAESAR DELUXE

Ave! A funny thing happens on the way to the forum as it emerges that Impressions' already excellent Roman sim is now upgraded...

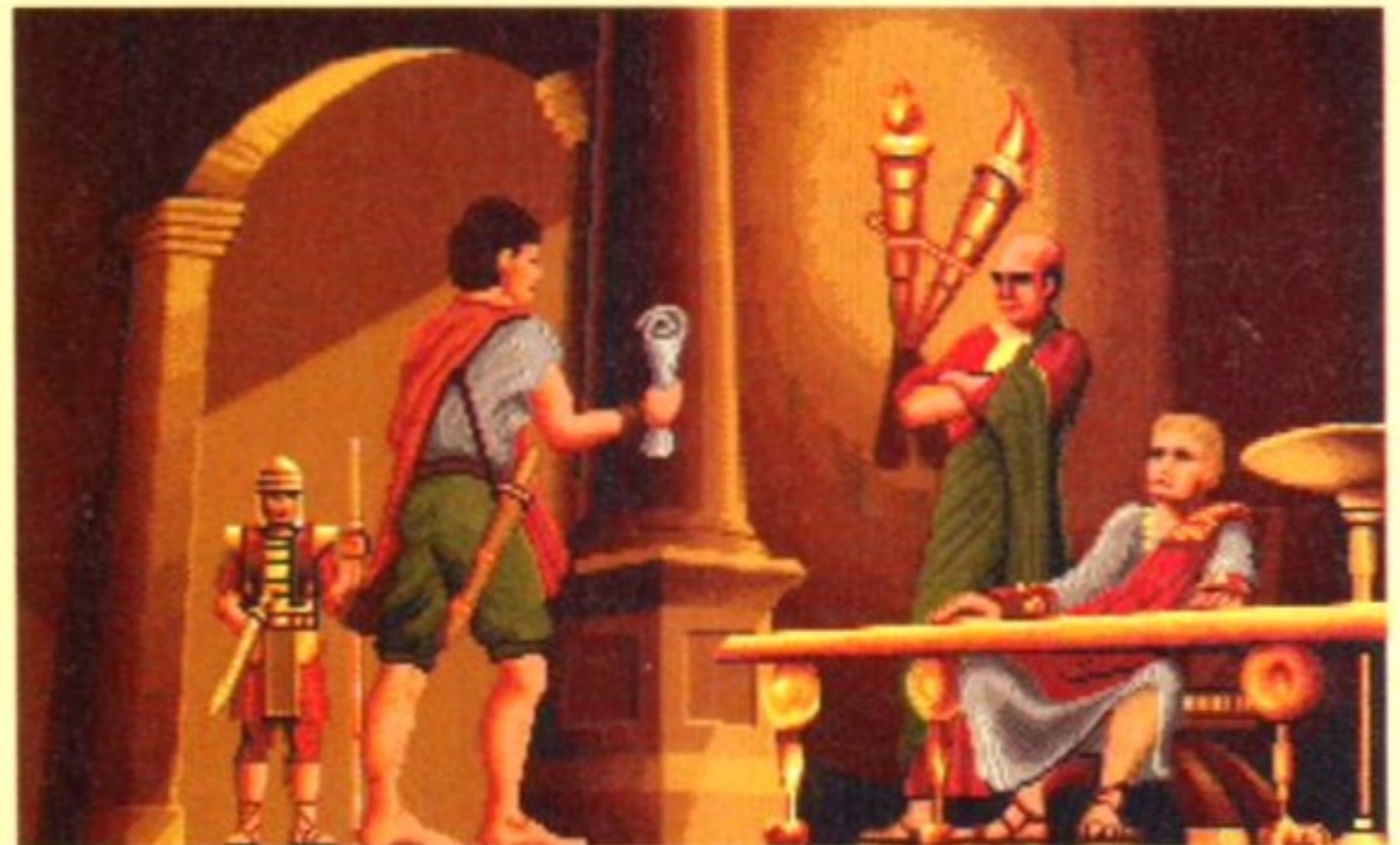

LOCALS LOCALS ARE DEMANDING A NEW FORT.

"It's like this, boss," protests Claudius Dubius, representative of the citizens. "The people want a new fort, or they may soon be revolting." "But they're already revolting," Caesar replies wittily...

Creating a sequel is a difficult task, particularly if the game you are trying to enhance is a classic in its own right. *Caesar* had everyone donning a toga and plumed helmet, prancing about in front of their Amigas with delight (well, we did). Perhaps it's a good thing, then, that *Caesar Deluxe* has been designed to tweak and complement aspects of the original rather than introduce drastic changes.

Civis Romanus Sum

If you attach no significance to the name *Sim City* then you have truly missed a classic – a rigorous test of urban planning and development. *Caesar* was a clone of that landmark production.



Nevertheless, it received the coveted *Format Gold* award thanks to



added dimensions of defence and conquest and its cute little houses. The object of *Caesar* is to help the empire by establishing a city within the province over which you have jurisdiction. Building the city is difficult because you must monitor many aspects of its development, but your ability as a governor are represented by the four pillars of Roman civilisation: Peace, Culture, Prosperity and Empire.

Increasing each of these is hard, but the difficulty of juggling several problems at once is what makes *Caesar* so fascinating. The state of the first three aspects can be improved by building defensive walls, creating more amenities for your citizens, increasing industrial output and so on. Your imperialist abilities, on the other hand, are gauged according to your city's expansion on a provincial level and a new feature allows you to create Imperial Highways which connect your city to other provinces as well as other towns.

This makes *Caesar Deluxe* even bigger than its predecessor. Just remember, though, that you'll also have marauding barbarians pounding at your gates and other disasters to cope with, so preparation for the worst is essential. A catastrophe can have repercussions which shatter the city, but desperately taking steps to save it is just as enjoyable as watching it grow.



Then, as now, independent financial advice was crucial and the new *Deluxe* council member fulfils this role. (Caption sponsored by LAUTRO).

Dulce et decorum est...

In order to develop the city you must monitor its progress and this is done with the help of several advisors who are found at the forum. Here, the changes rung by *Caesar Deluxe* really begin to show with the addition of another counsellor to your merry band. He joins the existing oracles of fiscal and social information as a sort of Department of Trade and Industry inspector (BC), offering advice on industrial expansion in your province.

An odd change to the game is that slaves are now called 'plebs'. Other enhancements in the game are mainly designed to add to the fluidity of play, and include a rearrangement of the main icons and the addition of a viewfinder to the main, bird's-eye view window. There's also a panel that explains icons as you slide your mouse-pointer over them frantically while the city burns to the ground. The new control system only fractionally improves the whole arrangement, but it was already excellent in the first place.

Overall, the game has been polished in all respects, right down to packaging and documentation, but don't expect this to be a sequel. Impressions have almost achieved a version that is genuinely 'Deluxe', but you have to ask yourself whether it is worth paying £14.99 for a what is only a very slight upgrade.

Caesar remains a classic and if you don't have the original invest in this. However, with the impending release of *Sim City 2000*, a new empire is about to be founded.

Rob Mead



Cogito Ergo Sum City. The viewpoint and the gameplay both show the influence of Maxis's classic town-building strategy simulation.

CAESAR DELUXE



PROGRAMMERS

Simon Bradbury

PUBLISHER

Impressions 071-351 2133

PRICE

£29.99 (upgrade for £14.99)

RELEASE

Out now



GRAPHICS

1 2 3 4 5 6 7 8 9 10
Solid, emotional, imperial.

SOUND

1 2 3 4 5 6 7 8 9 10
Good music, effective effects.

ADDICTION

1 2 3 4 5 6 7 8 9 10
Needs a health warning!

PLAYABILITY

1 2 3 4 5 6 7 8 9 10
Immense, fluid, enjoyable.

VERDICT

“ Continues its inexorable march through the hall of fame with this friendly more attractive version. Worth buying but not upgrading to. ”

92%

APEX WILL BACK-UP ALL KNOWN SOFTWARE - GUARANTEED !!! ESSENTIAL FOR ALL AMIGA A5000/A500+/A600 & A1200 USERS

MORE POWERFUL THAN ANY OTHER BACK-UP SYSTEM AVAILABLE GUARANTEED.

INCORPORATING LATEST TECHNOLOGY ASY
ADVANCED SYNCRO TECHNOLOGY
QUICK & EASY TO USE & INSTALL EXTERNAL DRIVE
REQUIRED. FULL COMPREHENSIVE EASY TO USE
MANUAL ON APEX + TOOLKIT

FULLY AUTOMATIC HARDWARE/SOFTWARE
ROUTINES TO COMBAT ALL PROTECTION.
APEX CARTRIDGE USES LATEST TECHNOLOGY
CUSTOM CHIPS FOR INCREASED POWER AND
RELIABILITY. NO OTHER COPIER OFFERS THIS,
ONLY SOFTWARE UPDATES !!!
INCREASED
POWER !!

£39.95

INCLUDING P/P & VAT
**NOW INCLUDES
APEX TOOLKIT**

APEX TOOL KIT



NOT ONLY THE BEST BACK-UP SYSTEM BUT SO MUCH MORE !!!

**THE MOST POWERFUL AMIGA DISK BACK-UP SYSTEM EVER !!
THERE IS NO SOFTWARE THAT CANNOT BE BACKED UP USING APEX**

ORDER APEX NOW & COPY ALL YOUR SOFTWARE - GUARANTEED !!

1988 COPYRIGHT ACT. ASHCOM DESIGN & DEVELOPMENTS LTD NEITHER CONDOES OR AUTHORISES
THE USE OF ITS SOFTWARE FOR THE REPRODUCTION OF COPYRIGHTED SOFTWARE.

EXISTING APEX USERS CALL
FOR TOOL KIT VERSION

A1200 2MB RAM EXPANSION

2MB OF 32 BIT FAST RAM
ZERO WAIT STATES
CO-PROCESSOR FACILITY
FITS IN TRAPDOOR

£109

SPECIAL OFFER !!!

AMIGA EXTERNAL DRIVE

AMIGA A1200, A600 & A500
THROUGH PORT
STYLED CASE
VERY HIGH QUALITY
12 MONTH WARRANTY

£49.95

STYLISH DRIVE FOR ALL AMIGA'S PLEASE ADD £2.50 P/P
SPECIAL OFFER - APEX + DRIVE £75 INC

A500 1/2 MEG + CLOCK £16 NO CLOCK £14
A600 1MB + CLOCK £45 - A500 + 1MB £43
DEALERS CALL FOR SPECIAL OFFERS

ALL PRICES INCLUDE VAT & P/P. NORMALLY DESPATCHED WITHIN 48HRS - MON-FRI 9.00-5.30 SAT 9.30-2.00

ASHCOM
DESIGN & DEVELOPMENTS LTD
10 THE GREEN, ASHBY-DE-LA-ZOUCH,
LEICESTERSHIRE LE61 5JU

TEL: 0530-411485
FAX: 0530-414433





GORTWARY



COMPUTERS

AMIGA A4000/040

The flagship of the Commodore Amiga range. Based around the EC68040 processor. Comes with Hard Drive, 2+4 RAM and WB3.

120Mb version	£1919
170Mb version	£1939
250Mb version	£1979
340Mb version	£2069

AMIGA A4000/030

The same specifications as it's big brother but built around the 68030 processor. Comes with a Hard Drive, 2+0 RAM and WB3.

FOR 2+2 ADD £19

85Mb version	£939
120Mb version	£969
170Mb version	£1029
212Mb version	£1059
256Mb version	£1089
340Mb version	£1149
426Mb version	£1199

AMIGA A1200

The machine for everyman. The A1200 sports many features of the 4000 series. Based around a 68020 processor, 2Mb of RAM and WB3 as standard. A full range of hard drives can also be fitted.

Basic	£289
40Mb HD	£388
85Mb HD	£468
120Mb HD	£494
170Mb HD	£528
212Mb HD	£548
250Mb HD	£578

AMIGA A600

The wild, wierd and wicked. This is the ideal entry level package. It contains a varied selection of software that displays the best of the Amiga's abilities.

A600 Basic	£189
A600 with wild,wierd&wicked	£215
40Mb HD version	£279
80Mb HD version	£369
120Mb HD version	£419

MONITORS

We carry the full range of Commodore monitors. All are specifically designed for use with the Amiga range of computers. All monitors include leads and a tilt & swivel stand and they are all colour co-ordinated for the fashion conscious.

1960 Multisync	£339
1940 .39 dpi dualsync	£279
1942 .28 dpi dualsync	£379

ACCELERATORS

Our accelerators are produced for the A1200 by GVP, a watch word in quality and reliability. Both boards are user fittable via the trapdoor so as to maintain your warranty.

GVP FANG BOARD

This board has slots for up to 8Mb of RAM, a maths co-pro and has and includes an SCSI interface as standard.

0Mb/NO FPU	£179
4Mb/33MHz FPU	£349
SCSI CABLE KIT	£44

GVP JAWS BOARD

This board features a 68030 processor as standard and also has slots for up to 8Mb of RAM and maths co-pro.

0Mb/NO FPU	£269
4Mb/40MHZ FPU	£439
GVP ACCESORIES	
33MHz 68882 FPU	£69
40MHz 68882 FPU	£119
32bit 1Mb RAM	£59
32bit 4Mb RAM	£153

SCANNERS

Power Computing Handheld Greyscale Scanner V3.....	£99
EPSON	
GT6500 A4 Flatbed Colour Scanner.....	£899
GT8000 A4 Flatbed Colour Scanner.....	£1149

HD BACKUP

TAPE STREAMER

This 40Mb tape streamer is the ideal back-up device for hard drives fitted to the A4000. It is supported by Quarterback Tools and only requires fitting by the user

40Mb TAPE STRAEMER	£199
--------------------	------

UPGRADES

AMIGA A4000 SERIES

CD ROM DRIVE

includes SCSI controller.....	£399
MATHS CO-PRO (PLCC)	
25MHz 68882	£89
40MHz 68882	£139

PC EMULATORS

supplied with manuals and MS DOS 5	
386 SX	£199
486 SX	£299
SVGA GRAPHICS CARD	£49

MEMORY

single sided SIMMS module	
1Mb RAM	£39
4Mb RAM	£149

AMIGA A1200 & A600

PCMCIA CARDS

2Mb RAM	£109
4Mb RAM	£169
1Mb STATIC RAM	£109
2Mb STATIC RAM	£169

AMIGA A4000 SERIES

3.5" HARD DRIVES

85Mb.....	£129
120Mb.....	£149
170Mb.....	£189
212Mb.....	£229
250Mb.....	£249
340Mb.....	£299

AMIGA A1200 & A600

2.5" HARD DRIVES

40Mb.....	£99
85Mb.....	£179
120Mb.....	£279
200Mb.....	£329

MODEMS

All our modems are produced by PACE, an established name in telecommunications. Complete with software.

LINNET PLUS.....	£139
LINNET2400.....	£179
LINNET QUAD.....	£224
MICROLIN pocket modem.....	£359
MICROLIN fax/modem card.....	£269
ULTRALINK 32 PLUS.....	£629
ULTRALINK QUAD.....	£269

SOFTWARE DEMON LTD

38/40 QUEENS CHAMBERS
QUEENS STREET
PENZANCE TR16 4HB
CORNWALL
PHONE (0736) 331039
FAX (0736) 331499
TRADE (0436) 318988

OPEN 6 DAYS A WEEK

MON-FRI..... 9.00AM-6.00PM
SAT..... 10.00AM-3.00PM

HOW TO ORDER

BY PHONE

To order by phone you'll need your credit card number and expiry date. Please be sure to quote the correct card address or we'll avoid delays.

BY POST

When ordering by post please include a full description of the goods and the price. It is a good idea to phone before ordering so as to avoid disappointments. Please make all cheques and postal orders payable to SOFTWARE DEMON LTD, and allow 5 working days for cheques to clear.

OR VISIT OUR SHOP

If you are in the area or live locally please don't hesitate to visit our shop. Our friendly staff are available for advice and are willing to demonstrate any of our stock to give you a better idea of what you want. Our shop also carries the full range of latest entertainment software and has a games zone where you can park the kids or play the latest games.

Please note that in our effort to bring you the best value available our prices are subject to change without notice. This does not necessarily mean that the prices will go up.

DELIVERY

All purchases are made up to order and then dispatched. All customer modifications generally take 3-4 days to do. The goods are then dispatched via our courier service on a 24 hour delivery schedule. If no one is available to receive the goods then the courier will leave a card explaining how to arrange a delivery to suit you. Saturday delivery can be arranged at a small surcharge.

DELIVERY £19
PICKUP & FIT SERVICE £99

DEMON



AT THE CUTTING EDGE

THIS SECTION CONTAINS THE RESULTS OF THE MOST RECENT DEVELOPMENTS IN THE WORLD OF THE AMIGA

HARD DRIVES

SCSI 2 HARD DRIVES

This generation of hard drives produced by Conner support the new **ADVANCED COMMAND SET** and achieve a new standard in data transfer rates, anything upto 10Mb/sec. These drives can be fitted to both the A4000 series and the A1200. The A4000 needs to be fitted with the A491 SCSI 2 board and the A1200 needs the GVP Fang board.

85Mb	£139
170Mb	£179
212Mb	£219
249Mb	£299
540Mb	£629

SCSI 2 INTERFACE

The A491 SCSI 2 interface enables the Amiga A4000 series computers to utilise the blistering speed of the SCSI 2 hard drives. This board is user-fittable and fits into one of the internal Zorro III slot of the A4000.

Transfer rates: 5Mb/sec async
10Mb/sec sync

A491 SCSI 2 INTERFACE	£239
-----------------------	------

MISCELLANEOUS

CD32 CONSOLE

This machine represent the future of home entertainment and video game play. A self contained CD console which you can expand to a full CD based home computer. It is built around true 32bit technology with 256 screen colours, 68020 processor with a 14MHz clock speed and high resolution screen display. Optional extras include a keyboard, floppy drive, mouse and a hard drive. All of which will be available soon.

ALL FOR THE MEASLY PRICE OF £279

Phone for the latest software

EXTERNAL DRIVES

PCMCIA INTERFACE

These hard drives come in an ABS box styled to match the Amiga A1200. They plug in via the PCMCIA slot and include an external PSU so as not to invalidate your Commodore warranty. Ultra fast data transfer rate of 2Mb/sec. Full 3 year return-to-base guarantee. They come supplied with all the necessary software to mount and configure the drive.

40Mb	£169
85Mb	£229
170Mb	£299
220Mb	£319
250Mb	£349
340Mb	£399
426Mb	£499

PARALLEL PORT INTERFACE

These hard drives come supplied in an external ABS box with a parallel port interface. All specs on the hard drives are identical to those of the PCMCIA hard drives and all the necessary software is included.

40Mb	£199
85Mb	£259

CIVILIZATION AGA

This is it, the bees Knees. It's the ultimate god game. This game is Microprose's flagship, it's won a host of awards and now it's been upgraded to make the most of the new AGA chipset. If you don't already own a copy of Civilization then you don't know what your missing, and if you have an original copy then you'll be stunned by the improvements. So either buy it now or upgrade and get into the most serious game of all time.

**CIVILIZATION AGA £39
UPGRADE £19**

To upgrade just send the 4 original disks enclosing £19 and your name and address.

SOFTWARE

BUSINESS

HOME ACCOUNTS 2	£37
ARENA ACCOUNTS	£89
CHARTS & GRAPHS	£35
MINI OFFICE	£38
SYSTEM3 ENHANCED	£69
MAILSHOT PLUS	£39
SUPERBASE4 PRO	£199
ADVANTAGE V1.01	£49
DGCALC	£29

MUSIC

AUDIO MASTER IV	£49
MUSIC X JR	£29
SUPER JAM	£79
X-OR V1.1	£179
BARS & PIPES PRO	£249

PROGRAMMING

AREXX	£25
AZTEC V5.0D	£199
AZTEC V5.2	£109
CAN DO V1.6	£79
CAN DO V2.0	£99
HISOFT BASIC	£45
DEVPA3	£49
VISIONARY	£59

UTILITIES

DIRECTORY OPUS V4.0	£49
CROSS DOS V5.0	£32
DISKMASTER V2.0	£39
GB ROUTE PLUS	£45
DISTANT SUNS	£49
AMIBACK V2.0	£44
QUATERBACK TOOLS V1.5	£45
QUATERBACK V5.01	£40
X-COPY PRO INC. HARDWARE	£33

VIDEO & GRAPHICS

IMAGINE V2.0	£119
REAL 3D PRO TURBO	£77
SCENERY ANIMATOR V2.02	£59
VIDEOSCAPE 3D	£75
VISTA PRO V2.0	£49
X-CAD 2000	£139
X-CAD 3000	£349
CALIGARI 2	£219
ART DEPT V2.15	£145
DPAINT IV AGA	£67
DPAINT IV	£49
MORPH PLUS	£147
TAKE 2 ANIMATION	£39
DELUXE VIDEO III	£79
SCALA V1.13	£199
ADORAGE	£61
ANIMAGIC	£79
TV SHOW 2	£49

WP & DTP

FINAL COPY II	£77
ART EXPRESSIONS V1.0	£119
KINDWORDS V3	£29
WORDWORTH V2.0	£99
PAGESTREAM V2.2	£159

SOFTWARE DEMON LTD CUSTOMER CHARTER GENERAL POLICY

We at SOFTWARE DEMON LTD endeavour to bring you the best value at the cheapest price possible. This is not easy in this day and age of multi-national corporations bulk buying everything in sight and then selling it as fast as possible, not caring where it goes just as long as they get the cash.

Here we believe in the personal touch, all our products are made to order for each individual then tested and dispatched. No box sitting and no rush. We may not be the fastest but we take pride and great care in what we do. Each customer receives the best service possible.

OUR GUARANTEES

All our standard Commodore products are genuine UK specification, no foreign imports and no dangerous electrical standards. They all receive a 1 year on site warranty.

All the products modified or fitted by SOFTWARE DEMON LTD receive our own 1 year Return-to-Base, fit or replace warranty. If a software Demon product fails within 1 year of purchase due to faulty parts or workmanship, we will replace the goods by courier, return them to them, fit or replace them and return them to you free of charge.

AFTER SALES SERVICE

At SOFTWARE DEMON LTD we firmly believe in caring for our customers, past and present. There will nearly always be somebody available on line to answer any question or help with any problems you may have. We are also willing to give advice on purchasing any computer related products and to help you choose the right equipment to suit your needs. If you ring for a chat, our technicians have been known to get very bored just listening to machines all day.

If you have any queries just phone -
TECHNICAL SUPPORT
(0738) 331499

ALL PRICES SUBJECT TO CHANGE
WITHOUT NOTICE £808
ALL TRADEMARKS ACKNOWLEDGED

REPAIRS

REPAIRS

Repairs
to Amiga
500/600/1200.
Cost effective
repairs for just
£15.00
to obtain a
quotation
plus parts.



Typical repair price £39.00
All repairs soak tested and warranted for 90 days.
Upgrades and hard drives supplied and fitted.
Send or hand deliver your computer to our showrooms.
Collection service available.

★ Please include a fault description, contact telephone number
and address when submitting your computer.

0234 218228 ASK FOR WAYNE
COMPUTER MALL, THE HARPER CENTRE, BEDFORD MK40 1TP

P.M. Solutions Ltd

5A Ashby Square, Loughborough LE11 0AA.

 **9am to 5pm** **Monday to Friday** 

Amiga A4000/030 2Mb Chip 0Mb Fast 80Mb £940 2Mb Chip 0Mb Fast 120Mb £1040	Amiga A4000/040 2Mb Chip 4Mb Fast 120Mb £1980
Amiga A1200 A1200 2Mb Chip 0Mb HD 0Mb Fast £285 A1200 2Mb Chip 85Mb HD 0Mb Fast £495	SCSI Controllers A4091 SCSI 2 Controller £215 GVP's SCSI for A1200 £289
GVP Accelerators A1230 40MHz 68EC030 0Mb £280 A1230 40MHz 68EC030 4Mb £480	Monitors Microvitec 1440 15Khz to 38Khz £430 <small>(No sound)</small> Commodore 1940 dual sync 0.39 £275 Commodore 1942 dual sync 0.28 £375 <small>(Come with internal amp 1 Watt and Speakers)</small>
Misc 4Mb Simms £145 Bridgeboard A2386sx25 £195	

Order Line: 0509 260172

Fax Line: 0509 238561

*Prices include VAT at standard rate.
All prices subject to change & delivery*

Mail Order Express Distribution

10 COMMERCIAL STREET, BATLEY, WEST YORKSHIRE WF17 5HH

CALL US ON 0924 422057 OR 0924 422226, MON-SAT 8.00AM-8.00PM

SYNDICATE

£21.99





**NIGEL
MANSELL**

£15.99

3D Construction Kit 2.0.....£32.99	Doodlebug.....£15.99	Premiere.....£15.99	Wizkid.....£15.99
Addams Family.....£12.99	Easy Amos.....£21.99	Premier Manager.....£14.99	WWF2.....£15.99
Adventurers.....£15.99	Elite.....£15.99	Pushover.....£15.99	Zool.....£14.99
Arthur Macleans Pool.....£15.99	F15 Strike Eagle 2.....£15.99	Putty.....£15.99	Zydec External Drive.....£50.99
A-TRAIN.....£21.99	Fascination.....£14.99	Railroad Tycoon.....£16.99	Zydec Zy-Fi Speakers.....£38.99
AV8B Harrier Assault.....£15.99	Fate of Atlantis.....£22.99	Raving Mad.....£15.99	Zydec Handy Scanner.....£94.99
Award Winners.....£21.99	Fire & Ice.....£15.99	Reach for the Skies.....£18.99	Zydec Virus Protector.....£5.99
B17 Flying Fortress.....£21.99	First Samurai/Megalomania.....£15.99	Road Rash.....£15.99	Alfa Data Trackerball.....£29.99
Battle Isle.....£15.99	FLASHBACK.....£18.99	Sabre Team.....£15.99	Crystal Trackerball.....£34.99
Battle of Britain.....£15.99	Formula 1 Grand Prix.....£19.99	Sensible Soccer.....£15.99	Alfa Data Megamouse.....£13.99
Big Box 2.....£17.99	GOAL.....£18.99	Shadow of the Beast 3.....£15.99	14 Inch Monitor Stand.....£11.99
Bills Tomatoe Game.....£15.99	Graham Taylors Soccer.....£13.99	SILENT SERVICE 2.....£19.99	Mouse Pockets.....£1.99
BODY BLOWS.....£15.99	GUNSHIP 2000.....£21.99	Sim Earth.....£21.99	Mouse Mats.....£2.50
Captive.....£10.99	Heimdall.....£15.99	Soccer Kid.....£18.99	Cleaning Kits.....£1.99
Carl Lewis Challenge.....£15.99	Historyline.....£21.99	Space Legends.....CALL	
Championship Manager 93.....£15.99	Kings Quest 5.....£21.99	Special Forces.....£21.99	
Chaos Engine.....£15.99	Legend of Kyrandia.....£22.99	Strategy Masters.....£18.99	
Civilization.....£21.99	Lemmings.....£14.99	Street Fighter 2.....£16.99	
Combat Classics.....£18.99	Lemmings Twin Pack.....£21.99	Superfrog.....£15.99	
Conquest of the Longbow.....£15.99	Lemmings 2.....£19.99	SUPER TETRIS.....£15.99	
Cool World.....£15.99	Lotus Turbo Challenge 2.....£12.99	SYNDICATE.....£21.99	
Crazy Cars 3.....£15.99	Lotus Turbo Challenge 3.....£15.99	The Greatest.....£21.99	
Cool Croc Twins.....£15.99	Microprose Golf.....£14.99	Thunderhawk.....£15.99	
Cruise for a Corpse.....£15.99	Monkey Island.....£15.99	Titus the Fox.....£14.99	
Curse of Enchantia.....£21.99	Monkey Island 2.....£22.99	Troddlers.....£15.99	
Desert Strike.....£18.99	Nigel Mansell's Formula 1.....£15.99	WALKER.....£18.99	
Dizzy's Excellent Adventures.....£14.99	Pinball Dreams.....£15.99	Ween.....£14.99	
D/Generation.....£10.99	Pinball Fantasies.....£15.99	Wing Commander.....£15.99	

DISKS

50	£22.95
100	£41.70
200	£78.75
300	£116.30
400	£154.50
500	£184.65

PRICES MAY CHANGE WITHOUT
PRIOR NOTICE. PLEASE CALL FOR
LATEST PRICING
We accept Cheques, postal orders, Access
and Visa cards.
1st class recorded delivery as standard on
all items.

P+P £1 PER ITEM 1ST CLASS RECORDED DELIVERY

**Get your
head
around
this →**



SEGA

BBC RADIO 1



BBC Radio One FM will be broadcasting
live from the show

AMTGA[®] games!



Aladdin

Come to FES on Friday and get a free
ticket to see Disney's huge Xmas hit -
before it's even released!

The year's **biggest games event**... GamesMaster TV broadcast live Thursday evening; and the
GamesMaster Show live all day every day... see all the **latest hardware** and games first at FES...
National Computer **Games Championships** final... BBC Radio One live...

- Tickets are only available in advance!
- The only way to get tickets is to phone **051-356 5085**. Call now!
- Price **£6.95** each or **£24.95** for family groups of four (with at least one adult). Note: *no* tickets will be available for sale on the day

The Future Entertainment Show **hotline** is now open: **051-356 5085**

Future Entertainment Show

PO Box 2, Ellesmere Port, South Wirral L65 3EA

Future Entertainment Show priority form

AF 11/93

State your preferred date to come to the **Future Entertainment Show**. We'll do our best to send tickets of your first choice, but should these be unavailable we will send you your preferred alternative. Please put **1** against your first choice and **2** against your second:-

- Thursday 11th Friday 12th
 Saturday 13th Sunday 14th

Please reserve the following tickets for me:

Advance booking	Number required	Total £
£6.95 (Single ticket)	<input type="checkbox"/>	£ <input type="text"/>
£24.95 (Family ticket)	<input type="checkbox"/>	£ <input type="text"/>
Grand Total £		<input type="text"/>

Method of payment: (Please tick appropriate box)

- Cheque Postal Order Visa Access

Please make cheque payable to: **Future Entertainment Show**

Credit card no:

Expiry date:

Please fill in this coupon clearly in **block capitals**

Name

Address

Postcode

Telephone

Signature Date

Please tick here if you don't wish to receive
direct mail from other companies

Please note your tickets will be sent to you eight weeks before the show. Please return this form, your payment and SAE to:- The Future Entertainment Show, PO Box 2, Ellesmere Port, South Wirral L65 3EA

Now featuring -
GAMESMASTER
every day!
live all day

**The second
Future
Entertainment
Show**

November 11 - 14 London Olympia



→ See! Play!
And buy all
the hot new

MICRO MAC

Look, I really don't want to write about this game, I just want to play it. Even as I sit here, somebody has wandered over and started playing it and already I'm jealous. Maybe I could have a quick game? But then there's no such thing as a quick game of *Micro Machines*.

It's probably a bit complicated to explain, but please bear with me. You race a very small car across a breakfast table, avoiding milk and cereal. It's that simple. (I lied before.) All right, you also sail boats in the bath, fly helicopters in the garden, drive tanks across a games table and negotiate racing cars around a pool table. And it's absolutely bloody

brilliant. I don't think you need to know anymore than that really. Stephen Bradley. *Amiga Format*.

Right, now it's time for a game of *Micro Machines*. What do you mean you want to know more? Shoo. Go on. Outta here.

You can't talk about this game. Not like, say, *Soccer Kid*, where you can tell your mates about all the clever tricks he can do, and the interesting places he goes. These diddy cars haven't got any special characteristics. They're small and they zip around the house. End of story.

OK, OK. It's for one or two players. Satisfied? All right, here's more. Five smirk-inducing, but dastardly deeds you can do to your mates in *Micro Machines*. **1.** Force their

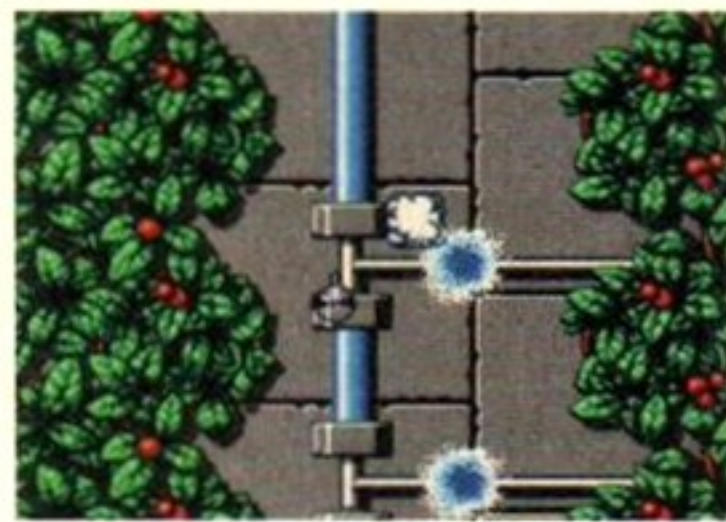

Garden sprinklers are the curse of the chopper. Jan Michael Vincent from *Airwolf* was only last week telling me of the problems they cause.



Dice with death before losing your marbles. Play *Toy Soldiers* in Martika's *Kitchen*. Get tanked up on some draught beer and fall on the floor.

HINES



powerboat down the plughole in the bath. **2.** Knock them into an orange. **3.** Edge them off the side of a ruler. **4.** Blow them up with your tank. **5.** Nudge them onto a lawn sprinkler. And the thing is, it's all so wonderfully childish. Married men have sat before the screen, giggling after bashing each other's boats into a rubber duck.

This game is not sensible. There are 24 courses, eight types of scenery, 11 different drivers and four ways to race. But it's in two player mode that *Micro Machines* really comes to life. The game only uses one screen so both players must be on it at the same time. Unlike other racing games, the idea is not to zoom around the track faster than

your opponent, rather, to put enough distance between you and him until the scrolling catches up and he disappears off screen. Each time you do this you gain a bonus; once you've amassed eight, you win the race.

Heck, that's enough detail. *Micro Machines* is a game that makes you giggle in a daft manner and addiction is more a probability than possibility. Gripes? Well there's no parallax scrolling so the edge of the tables can be difficult to spot. And the shadows don't match the shapes of the cars. But we'll let them off just this once, eh? Driving a tank on a draughts board has never been so much fun - everybody should play this at least once in their life.

Steve Bradley

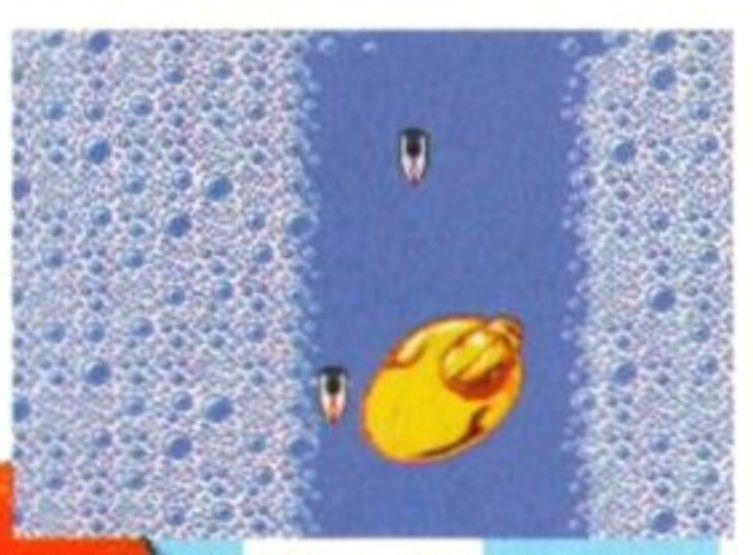

You will not be surprised to learn that this is the first time I have seen bathwater, powerboats and a rubber duck together in AF.



Something has got to give. Only one car at a time can pass over the rulers that bridge the desks, due to the rubber blocking the way.



PROGRAMMERS
Codemasters

PUBLISHER
Codemasters 0926 814132

PRICE
£25.99

RELEASE
Out now

GRAPHICS
[Progress bar]

Unusual, but nothing special.

SOUND
[Progress bar]

Not the game's highlight.

ADDICTION
[Progress bar]

Yes, yes, yes, yes, yes. Yes.

PLAYABILITY
[Progress bar]

Amazing in two player mode.

VERDICT

“ Not the kind of game you want to talk about, nor yet the kind of game you want to write about. A game you want to sit down and play and play and play and... ”

90%

COME AND HAVE A GO IF YOU THINK YOU'RE HARD ENOUGH

To the victor... £10,000



Remember this guy? Last year, Allan Brett became a celebrity overnight after he scooped the National Games Championships. Not only that though – as well as the glory, he also walked off with £10,000 IN HARD CASH.

Using outrageous skill, the 18-year-old from Hull managed to be the best on Sega, Nintendo and Amiga machines.

THIS YEAR THE GAMES CHAMP COULD BE YOU!

On this page you'll see the dates and venues for the first round eliminators. They're being held in Virgin Retail outlets in the major cities of Britain over the next few weeks.

All you have to do is turn up, and play. If you're good enough – and you'll have to be very good – you'll be into the next round. And after that... the finals at the Future Entertainment Show in London on 11 - 14 November.

The National Games Championship is organised by Future Publishing, producer of this, and many other great games magazines, and organiser of the Future Entertainment Show.

FREE ENTRY!

National GAMES CHAMPIONSHIP

THE DATES AND VENUES...

18 - 21 October	Final on 22 October
EAST KILBRIDE FALKIRK EDINBURGH	Games Centre Games Centre Games Centre 5 heats
GLASGOW	Megastore Megastore
25 - 28 October	Final on 29 October
BOLTON STOCKPORT MANCHESTER	Games Centre Games Centre Megastore 3 heats
BIRMINGHAM COVENTRY	Megastore Megastore BIRMINGHAM 2 heats
BROMLEY CROYDON GUILDFORD ILFORD KINGSTON WATFORD MARBLE ARCH MEGASTORE	Games Centre Games Centre Games Centre Games Centre Games Centre Games Centre Megastore Megastore MARBLE ARCH 9 heats
BRISTOL CARDIFF	Games Centre Megastore CARDIFF 2 heats
DUBLIN	Games Centre Megastore DUBLIN 2 heats
BELFAST	Megastore BELFAST 1 heat
GATESHEAD NEWCASTLE	Games Centre Megastore NEWCASTLE 2 heats
SHEFFIELD	Games Centre Megastore SHEFFIELD 2 heats
NORWICH	Megastore NORWICH 1 heat

THE GAMES YOU'LL BE PLAYING



Pinball Fantasies - CD32



Thunderhawk - MEGA CD



Mario All Stars - SNES

The second Future Entertainment Show



PINBALL FANTASIES



PROGRAMMERS

Digital Illusions

PUBLISHER

21st Century 0235 851533

PRICE

£32.95

RELEASE

September 22nd 1993.



GRAPHICS



256 colours, and it shows!

SOUND

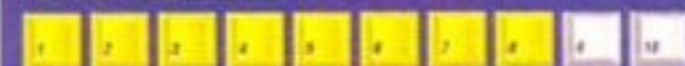

It's CD, innit?

ADDICTION



It really did change my life!

PLAYABILITY



It's pinball, innit?

VERDICT

“ One of the greatest games on the Amiga is even better on CD³². Life would be a worse place without this disc, a truly 'Classic CD' (crap mag pun). ”

85%



Party Land, the best table in *Pinball Fantasies*. Some people may try to tell you otherwise, but they aren't writing this review. So what I say goes!

Opinions are divided in the *Amiga Format* office. Richard Jones, a bit of a wizard with the silver ball and possibly the only man on earth who has the power to control gravity at will, believes that pinball is a game without any element of chance. That's easy for him to say. Personally, I believe that chance plays more than a small part in the shiny ball game. Come to think about it, many's the time the ball eludes Richard's preternatural control and slithers down the drain between his violently jerking flippers. If this is not chance, he must have chosen to ditch himself... strange tactic!

The pinball table is a closed system, all the variables are under the direct control of the laws of physics, therefore there can be no chance. Once we introduce chaos theory, and butterflies in Japan start affecting our game, the debate becomes even more heated. Then there's always the position of the moon which also needs to be taken into account...

The net effect of this conversation is that we play less pinball and drink less beer... the opportunity cost of philosophy, eh? One thing's for sure, if any game on earth is fundamentally analogue, it has to be pinball - world-class tennis is almost completely digital these days. So you could never successfully convert this mixture of genius, beer, spawn and gravitational anomaly to the antiseptic environment of the computer - could you?

PIN



Speed Kings, the brightest table in *Pinball Fantasies*. Some people may try to tell you otherwise, but they are obviously colour-blind!

JAMES POND 2

Life is strange. If some bloke tries to tell you otherwise, like that it's just a bowl of All Bran, or that it's what you make it, kick him in the crotch. He is obviously a dangerous loony. Life is strange.

I have spent the last few years of my life lamenting volubly that I didn't get to review *Robocod* when it first came out on the Amiga. Maff Evans reviewed it, back in issue 29, and a damn fine job he did too. Back then *Robocod* scored a huge 91 per cent, and time has not dulled the shine on this glisteningly great platform game. But times have changed and Evans has gone to be a knob-twiddler on *Future Music*.

I, ON THE other hand, have had the opportunity to review *Robocod* twice in the last four issues. First it was the all-new (well,

bits were new) and enhanced AGA version which surfaced in issue 49. In the 20 months since its original appearance, our fishy friend had put on five new levels, lots more colours, and absolutely no pounds and no pence. A feat well worthy of equalling its original score. Congratulations to Millennium for producing a truly enhanced AGA game.

Now, in issue... hold on, let me take a look at the cover... oh yes, issue 52, *Robocod* is back again. And this time James Pond is flashing his fins on CD³². Millennium can quite rightly be proud of themselves for the undeniable achievement of having got the first CD³² game on to the shelves (their *Diggers* beat it to the machine, but comes free when you buy one). Surely they deserve to sell bucket-loads of this game, then?

Well, they undoubtedly will. But whether they deserve to is a matter for debate.

The non-interactive nature of the printed medium makes debates a bit tricky, though, so we'll have a kind of kangaroo court. I'll make the case for the defence of this undeniably excellent game. Then I'll make the case for this being a cynical marketing move by a set of money-hungry capitalists, and then I'll give the game a score and get on with my life. You can draw your own conclusions.

CASE FOR THE DEFENCE

- *Robocod* has earned a coveted *Amiga Format* Gold award twice.
- It is, without a doubt, one of the most playable, enjoyable, colourful and generally suckworthy Amiga games ever. Ever!
- The CD³² version of *Robocod* has the



BALL FANTASIES

What a stupid bloody question. Digital Illusions did it almost a year ago with *Pinball Dreams*. They improved on it with *Pinball Fantasies*, and for a while we spent more time in the office after work than we did in the pub. Eventually we came to our senses and started playing real pinball, but for a while there we nearly earned our anoraks.

NOW IT'S OUT for CD³². Can it possibly improve on what is already one of the greatest games ever to grace the Amiga? Of course – there's 256 colour graphics for a start, with the already gorgeous tables now rendered even more gorgeous. On first impressions the gameplay seems to have been ruined by CD-isation. The screen is massive (well, our fabulous new Nicam stereo telly is, when compared to our old 1084S monitor), which is merely weird.

But scrolling is much faster, and the motion of the ball smoother. For some reason (possibly the 50 frames per second animation) the act of scrolling from the bottom of the table to the top, and back again, at high speed is nowhere near as nausea inciting as it used to be. Digital Illusions have been freed of making allowances for the limitations of 16-bit technology. The ball trajectory algorithms are now all computed by the speedy 32-bit 68020... and it shows.

These enhancements are disconcerting at first. All the shots seem easier to make than on the Amiga 600 version and visions of truly huge scores start flashing before your eyes. A few more games dismiss these illusions and after a few days' hard playing (hey! there's no other way to play pinball!) these dreams are diminished, and it becomes obvious that *Pinball Fantasies* CD³² is actually more challenging than the computer version. How much of this can be ascribed to the Joypad control method is a moot point, and of no interest to anyone.

THERE ARE ONLY two blots on this shining star of a game. Firstly, there's the excessive price. £32.95 is simply too much. What happened to lower prices on CD product? And secondly, and closely related, there is no reason why all four of the *Pinball Dreams* tables couldn't have been put on this disc as a bonus. There is no chance *Pinball Dreams* will ever stand alone as a CD³² product in the wake of *Fantasies*. For this tightness on the part of the publishers, this 95 per cent game gets downgraded a full 10 per cent.

Marcus Dyson



Stones and Bones, the easiest table to get a big score on. Some people might tell you otherwise...

ROBOCOD

same five extra levels as the AGA version.

● The CD³² version of *Robocod* has seven tracks of CD digital audio.

● The CD³² version of *Robocod* has full animation intro and a full electronic book containing secret F.I.S.H. information.

CASE FOR THE PERSECUTION

Robocod CD³² costs £29.95 – four quid more than the floppy version.

For years, publishers have been claiming that when CD software arrived it would be cheaper than disk stuff because it won't be as pirateable. The production costs of a CD are similar, or maybe even less, than the production costs of a two-disk game.

Is it possible that because *Robocod* CD³² is the first Amiga CD game available, and early buyers of the CD³² will have little choice, that Millennium are trying to turn a

fast buck? Or is it possible that despite all they have said, now the time to stand by their rhetoric has come, software houses are not in fact going to charge less for CD software? Are we going to be charged a premium for the fact that we are getting our games on shiny 12cm discs instead of blue 3.5-inch ones? Are we to believe that, although the development costs of the game have been covered by the floppy version, the cost of producing an average animation and a session musician soundtrack warrants a price hike?

I don't know the answer to these questions, but if I were you, I'd ask myself them several times before I shelled out more for a CD game than it costs on floppy.

Marcus Dyson

...and this is one of Robocod's many tall thin bits.

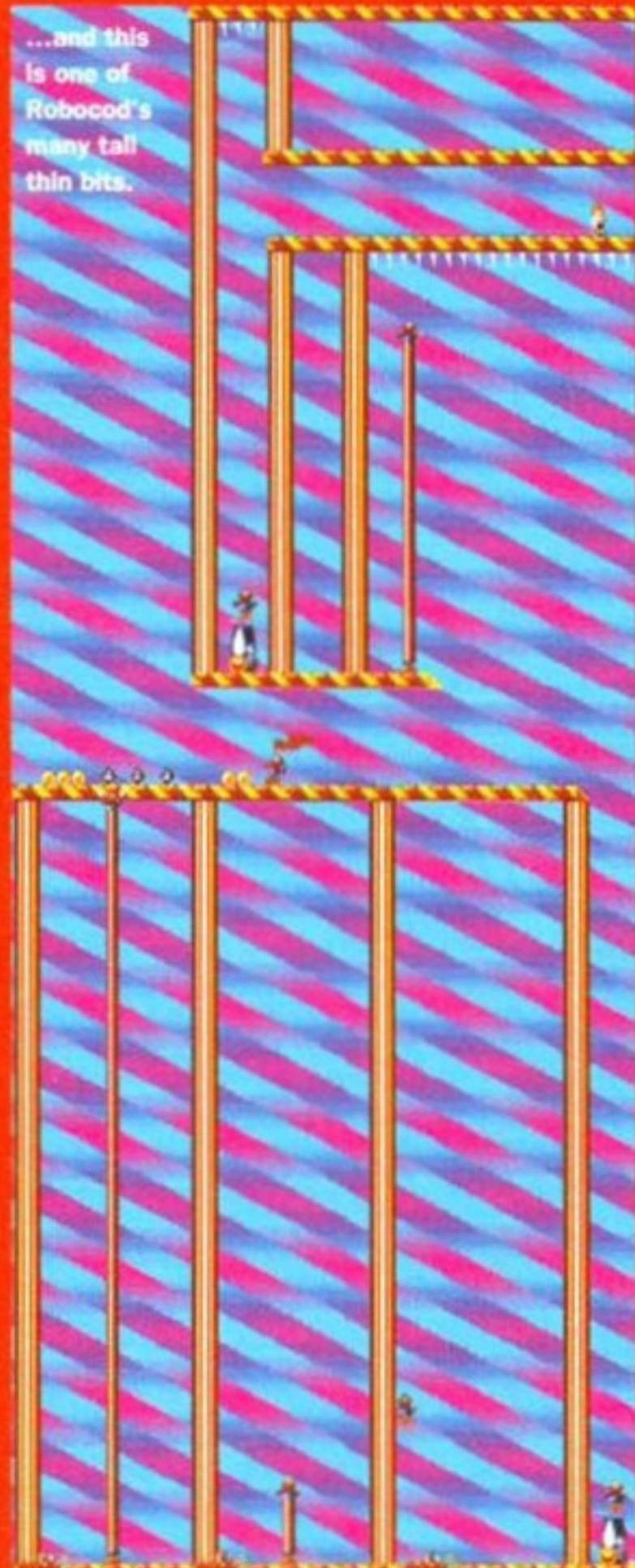

The thing about AGA *Robocod* is how subtly the enhancement has been done. You don't notice how colourful it is until you get the old version out. This is one of *Robocod*'s many long and thin bits...



JAMES POND 2 ROBOCOD



PROGRAMMERS

Chris Sorrell

PUBLISHER

Millennium 0223 844894

PRICE

£29.99

RELEASE

Out now



GRAPHICS



As great as ever...

SOUND



...better than ever.

ADDICTION



I have spent months on this.

PLAYABILITY



One of the best platformers.

VERDICT

“ There's no denying this is a great game, one of the best. But this is CD. So why does it cost more? Why weren't *James Pond* and *Aquatic Games* bunged on free? ”

85%

OPEN SUNDAY 10-3PM



Open Mon Fri 8am-6pm, Sat 8am - 4pm, OPEN SUN 10-3pm
 We're easy to find, just 1.5miles from the M62. Easy parking. Leave M62 at junction 26, take A638 to Bradford, uphill, after about 1.5 miles, past the park & just over a railway bridge, turn left onto New Works Rd. We're on the left 400yds further on opposite a PO mail box.
 Please note to avoid disappointment: Our technical & customer services personnel are not available to answer your queries or assist with any problems on Sundays.

SALES: 0274 691115

UNIT 1,
 253 NEW WORKS RD,
 BRADFORD, UK,
 BD12 0QP Est 1984
 FAX 0274 600150

SALES
 0274 69 11 15
 OPEN EVERY DAY

ACCESS VISA
 SWITCH DELTA
 CONNECT AMEX*

FAST PROFESSIONAL MAILORDER SERVICE
 SAMEDAY DESPATCH*

- Order by phone using your credit, charge, or debit card.
- Order by Mail - sending cheque bankers draft or postal orders payable to TRILOGIC.
- Please add part postage & packing of £1.00 to small orders under £100 or £2.00 to small orders over £100. Large/heavy or fragile items sent by overnight carrier only +£5.50. Overnight carrier - any order +£5.50 UK Mainland only. Scottish Highlands £7.50; N.IRELAND +£10.00; EIRE +£20

UK Saturday delivery - add £12.00 (Not available to Scottish Highlands. Goods remain our property until paid for in full.)

*AMEX SUBJECT TO 2% SURCHARGE
 *Subject to goods being in stock.

MOUSE & JOYSTICKS

ULTIMATE PRO ANALOGUE JOYSTICK NOW £19.99
 Superb low cost smooth action Analogue joystick with fire button on the end, plus pre-assignable X & Y trimmers, Microswitch fire buttons; autofire (not all games support autofire) ideal for flight simulators etc (Not all games support analogue joysticks)

MOUSE / JOYSTICK PORT SWITCH £12.99
 * Has sockets for mouse & joystick.
 * Push button selects mouse or joystick.
 * Uses no power unlike other types.
 * Saves wear & tear on mouse port.

- AMIGA TRACKBALL £34.99
- LEGEND BALL -POSH TRACKBALL £34.99
- CRYSTAL TRACKBALL £34.99
- MEGA MOUSE £15.99
- BUDGET REPLACEMENT MOUSE £15.99
- OPTICAL MOUSE £37.99
- PYTHON MICROSWITCH JOYSTICK £9.99
- TOPSTAR JOYSTICK £19.99
- HYPERSTAR JOYSTICK £15.99
- MEGASTAR JOYSTICK £21.99
- SUPERSTAR JOYSTICK £13.99
- EIPSTICK AUTOFIRE £12.99
- SPEEDKING AUTOFIRE £11.99
- SPEEDKING ANALOGUE £14.99
- NAVIGATOR JOYSTICK £13.99
- TURBO TOUCH 360 JOY PAD £14.99
- BUDGET PC JOYSTICK £14.99
- FX 2000 PC JOYSTICK £29.99
- WARRIOR PC JOYSTICK £19.99
- TAC 2 AMIGA JOYSTICK £9.99
- MOUSE MAT £3.99
- MOUSE HOLDER £1.99
- JOYSTICK EXTENSION LEAD (3m) £7.99pr
- 2 PLAYER ADAPTORS £9.99
- PC ANALOG JOYSTICK CONVERTER £7.99

DISKS & BOXES

3.5" LOCKABLE DISK BOXES ETC.
 HOLDS 40/50 DISKS HINGED LID £6.99
 HOLDS 80 DISKS HINGED LID .. £7.99
 HOLDS 100 DISKS HINGED LID .. £8.99
 HANDY 20 SIDE FLIP TOP BOX .. £1.99
 3.5" DRIVE HEAD CLEANER ... £3.99

TOP QUALITY BLANK DS/DD 3.5" DISKS (DYSAN) IN BOXES OF 10 WITH LABELS.
 1 PACK OF 10 IN STORAGE BOX £6.99
 2 PACKS OF 10 IN STORAGE BOX £11.99
 5 PACKS OF 10 IN STORAGE BOX £29.99
 10 PACKS OF 10 IN STORAGE BOX £54.99
 1PK OF 10 DS/HD 3.5" DISKS .. £11.99
 ROLL OF 1000 DISK LABELS ... £12.99

DUST COVERS

'SEAL N TYPE' TYPE THRU KEYBOARD SKIN.
 Don't risk spillages - they're guaranteed to 'write off' your Amiga.
 Waterproof & moulded to fit snugly over each key, but flexible enough to type thru.
 AMIGA 500, 500+, 600, 1200, 1500/2000 State which when ordering .. £12.99
ANTISTATIC DUST COVERS
 AMIGA 500 & 500 Plus £4.99
 AMIGA 600/600HD/1200 £4.99
 AMIGA 1500/2000 2PIECE £12.99
 AMIGA 1500/2000 KEYBOARD £3.99
 BB3 / 1084 MONITOR £6.99
 SWIFT 9, LC200 PRINTER £6.99
 SWIFT 24/LC24-200 £6.99
 CBM1960/CBSCAN 14" £7.99

DESKTOP VIDEO DEPT

- GVP GENLOCK £294.99** Composite or S-video inputs & outputs. Keyer capability; Built in RGB splitter for use with video Digitisers; audio input switching. Software & Amiga controlled.
- ROCGEN PLUS £139.99** A superb value Amiga Genlock with overlay & fader controls.
 ROCGEN £99.99
 ROC KEY £269.99
 Chroma keying unit - the ideal partner for the RocGen Plus - adds that professional touch.
- EPSON COLOUR SCANNERS - G76000, 65000, 80000 - low prices**
- VIDI 12 £ 84.99** REMARKABLY GOOD FRAMEGRABBER & RGB SPLITTER
VIDI 12sav £164.99 VIDI 12 + MEGAMIX SOUND SAMPLER & TAKE 2
SUPERPIC £499.99 HI QUALITY COLOUR FRAME GRABBER WITH GENLOCK
COLOURPIC £399.99 COLOUR FRAME GRABBER & DIGITISER
RENDALE 8802s £493.99 SVHS GENLOCK
RENDALE 8802PMC £179.99 8802 GENLOCK with faders + key nodes
RENDALE 8802 £134.99 BUDGET GENLOCK
GVP IV 24 from £989.99 24BIT GRAPHICS SYSTEM FOR A1500 & 2000

COMPUTER MUSIC DEPT

'MIRACLE' KEYBOARD ONLY £249.99 SAVE £50.00
 * Teaches you how to play"
 Includes 4 octave FULL SIZE touch sensitive Keyboard, with Midi interface built-in. + 100 instrument sounds & effects. + Artificial intelligence software for the Amiga which customises the lessons to each individual.

SUPERFI 2 STEREO SYSTEM HI FI QUALITY for only £54.99
A VERY HIGH QUALITY, 20 WATT STEREO BOOKSHELF SPEAKER SYSTEM.
 Not a cheap 'gimmicky' toy - BASS CONTROL Perfect for use with most Computers, + TREBLE CONTROL inc PC sound cards, keyboards, + VOLUME CONTROL Stereo VCRs, Satellite Systems & 32-ZONE RESPONSE Walkmans. Built-in mains supply - + PHONO INPUT SKTS no external adaptors req'd. * CONNECTING LEAD

PRO MIDI INTERFACE ONLY £27.99
VERSATILE 5 PORT DESIGN
 Our unique 5 port Midi interface has In, Out 4 thru sockets plus two additional switchable Out or Thru sockets for ingenious versatility. So you can have 1 in, 1 out & 3 thru, or 1 in, 1 thru & 3 out, or 1 in, 2 out & 2 thru!
 Fully compatible with all Amiga Midi software, & most keyboards.

TRILOGIC STEREO SAMPLER 2 ONLY £34.99
THE MOST ADVANCED 8BIT AMIGA SAMPLER THERE IS.
 Our Superb sounding STEREO SAMPLER 2 uses an expensive state of the art A/D chip which samples so fast, it captures every detail of the sound. Easily adjusted level control, connecting lead supplied. Fully compatible with all popular sampling software.
 FREE STEREO SAMPLING SOFTWARE

SPARES AND MISC ITEMS

ROM SWITCH ONLY £27.99
 Our keyboard operated Two way Rom switch enables you to use either of 2 Workbench roms. To switch over, just hold down Control/Amiga/Aniga keys until you hear a bleep. (Release then before the bleep to 'warm start' with the current rom. Fits A500/500+/1500/2000. Fitting invalidates computer warranty unless fitted by us. Fitting charge £15.00 Please state which you have Amiga ROM SWITCH & 1.3 ROM only £57.99
 ROM SWITCH & 2.04 ROM £64.99 when ordering.

AMIGA PRINTER PORT EXPANDERS
 For use with PRINTERS, SAMPLERS, VIDEO DIGITISERS ETC
 These compact Fully Switched Expansion boxes enable you to connect upto four peripherals to your computer. The connectors on the units are the same type as the Computer's printer connector so your peripherals just plug straight in. A connecting lead worth £10.99 - 2m for use with printers only, or 300mm long if used with Digitisers, scanners & samplers (state which req'd) is supplied free, to link the Expander to the computer. All 25 connections are switched. 36 way Printer sharers are also available - share one printer with 2 or more computers - phone for prices.

TWO WAY SCART SWITCH £19.99
 This compact switch box converts most TVs & TV monitors to DUAL SCART INPUT. Thus you can connect your Amiga & your VCR to the one scart socket on your Tv. A push button switch selects input one or input two - ie VCR or computer. RGB, Audio & Video inputs are switched.
 4WAY SCART SWITCH £39.99

SPARES SPARES SPARES AMIGA SERVICE DEPT

- TV MODULATOR (exchange) £19.99
 - TV MODULATOR no exchange £29.99
 - FATTER AGNUS B372A £39.99
 - KICKSTART 1.3 ROM £31.99
 - KICKSTART 2.04 ROM £39.99
 - SUPER DENISE £39.99
 - GARY £39.99
 - B520A I/O CHIP £15.99
 - A500+ MOTHERBOARD complete £99.99
 - A500 MOTHERBOARD- no socketed chips or ram chips £29.99
 - CBM MOUSE £14.99
 - A500 CASE £19.99
 - A500 KEYBOARD £59.99
 - AMIGA INTERNAL DRIVE £59.99
 - MAINS SUPPRESSOR BLOCK 4WAY £12.99
 - UPRATED A500 POWER PACK £44.99
 - CBM A500 PSU £37.99
 - GVP GENUINE PSU £69.99
 - EXTERNAL DISK DRIVE PSU £29.99
- AMIGA 500 REPAIR £49.99**
 Includes parts & labour, excludes psu, disk drive & keyboard faults. **FAST TURNAROUND**
 A520 MODULATOR REPAIR £19.99 **NEW**
 REPLACE INTERNAL DRIVE £69.99 inc drive
 A500 PSU REPAIR* £29.99
 FIT HARD DRIVE TO 600/1200 .. £15.00*
 (NO charge if fitted at time of purchase.)
 Add £10 for sameday turnaround (by prior arrangement only). *where spare parts available.
 Call in or send by Insured post enclosing return carriage - see 'How to Order' for carriage charges.
 Used Amigas from £100.

1901 MONITOR CONVERSIONS £69.99
 We can convert your 1901 monitor to work on the Amiga. Lead included. Please phone for details.

OFFICIAL ORDERS FROM GOVERNMENT & EDUCATIONAL ESTABLISHMENTS WELCOME.
 Note: Please phone if in doubt. (C) TRILOGIC 1993 All rights reserved.

DISCOUNT AMIGA SOFTWARE

BACKUP UTILITIES
X COPY PRO NEW £34.99
 Latest version - complete with NEW Mk 2 Automatic Cyclone external drive adaptor. Highly successful.
Mk1 CYCLONE ADAPTOR £12.99

- ADORAGE £67.99
- ADVANTAGE REDUCED .. £59.99
- AMI BACK £42.99
- AMI SUPERCARD II £34.99
- AMOS £34.99
- AMOS - EAST £25.99
- AMOS 3D £23.99
- AMOS COMPILER £21.99
- AMOS PROFESSIONAL - DOWN TO £39.99
- AMOS PRO COMPILER £25.99
- ART DEPT PRO AGA £169.99
- ART EXPRESSIONS NEW ... £145.99
- AUDIO ENGINEER 2 reduced. £159.99
- BARNS AND PIPES PRO £269.99
- BRILLIANCE EPOA
- BROADCAST TITLER 2 £169.99
- BROADCAST TILTER SUPERHIRES £299.99
- CAN DO V2 NEW VERSION ... £94.99
- CROSS DOS V5 £39.99
- DAY BY DAY £22.99
- DELUXE PAINT 4AGA £74.99
- DELUXE MUSIC 2 £54.99
- DEVPAC 3 £51.99
- DIRECTORY OPUS V4 ONLY .. £49.99
- FUN SCHOOL SPECIALS £39.99
- EAST AMOS £24.99
- ESSENCE £56.99
- EXCELLENCE 2 REDUCED .. £57.99
- FINAL COPY 2 NEW VERSION .. £80.99
- GB ROUTE PLUS REDUCED .. £35.99
- GOLD DISK OFFICE 2 £61.99
- HYPERCACHE £37.99
- HISOPT BASIC £49.99
- HOME ACCOUNTS 2 £41.99
- IMAGINE 2 REDUCED .. £164.99
- IMAGEMASTER £129.99
- KINDWORDS 3 £36.99
- LATTICE/SAS C V6 REDUCED .. £279.99
- MACRO 68000 ASSEMBLER £39.99
- MEDIA SHOW REDUCED .. £46.99
- MEGAMIX MASTER £36.99
- MINI OFFICE MAGAZIN .. £42.99
- MORPH PLUS £11 OFF .. £142.99
- ORGANISE £46.99
- PAGESTTER 3 £47.99
- PAGESTEAM 3 POA
- PENPAL STILL ONLY ... £35.99
- PERSONAL PAINT £57.99
- PERSONAL FINANCE MANG+ £19.99
- PRODATA REDUCED .. £69.99
- PROFESSIONALPAGE 4 £179.99
- QUARTERBACK 5 £41.99
- QUARTERBACK TOOLS DELUXE .. £114.99
- QUARTET £38.99
- REAL 3D PROFESSIONAL V2 ... £399.99
- SCALA £77.99
- SCALA PROFESSIONAL £199.99
- SCENERY ANIMATOR £67.99
- SOONMASTER - A GIFT AT .. £49.99
- STEREOMASTER SAMPLER £29.99
- SUPERJAM GIVEAWAY PRICE £39.99
- SUPERJAM 1.1 £89.99
- SUPERBASE 4 budget version .. £126.99
- SUPERBASE 4 - FULL VERSION .. £244.99
- TECHNOSOUND TURBO 2 £41.99
- TERRAFORM £34.99
- THE PATCHMEISTER £67.99
- THE PUBLISHER £37.99
- TURBOPRINT PRO V2 NOW ONLY .. £37.99
- VISIONARY £37.99
- VISTA PRO 3 £57.99
- VIDEOMASTER REDUCED .. £54.99
- WORDWORTH 2 aga £82.99
- XCOPY PRO -LATEST VERSION .. £34.99
- XCAD 2000 PRICE DOWNS .. £99.99

EDUCATIONAL
MANY TITLES REDUCED
 ADI ENGLISH; MATHS; FRENCH £18.99
 ADI JUNIOR RANGE £14.99
 BETTER MATHS (12-16) £17.99
 BETTER SPELLING (8+) £17.99
 DATAWORD £14.99
 DISTANT SONS V4.1 £52.99
 FUN SCHOOL RANGE £17.99
 FUN SCHOOL SPECIALS £18.99
 FRENCH MISTRESS £15.99
 GERMAN MASTER £15.99
 ITALIAN TUTOR £15.99
 JUNIOR TYPIST (5-12) £17.99
 KIDS ACADEMY RANGE - ALL .. £14.99
 LINKWORD LANGUAGES £21.99
 MICRO RANGE ALL £18.99
 MEGA MATHS £18.99
 NOODY'S PLAYTIME £18.99
 PLAYDAYS £18.99
 READING WRITING COURSE £18.99
 SPANISH TUTOR £15.99
 VOTAGER 1.1 £54.99

BOOKS & VIDEOS
BRUCE SMITHS BOOKS
 MASTERING AMIGA AREXX £21.95
 MASTERING AMIGA DOS 2 VOL 1 £21.95
 MASTERING AMIGA DOS 2 VOL 2 £19.95
 MASTERING WORKBENCH 2 £19.95
 MASTERING AMIGA C £19.95
 MASTERING AMIGA PRINTERS .. £19.95
 MASTERING AMIGA ASSEMBLER .. £24.95
 MASTERING AMIGA SYSTEM £29.95
 MASTERING AMIGA AMOS £19.95
 MASTERING AMIGA - BEGINNERS £19.95
 A600 INSIDER GUIDE £14.95
 A1200 INSIDER GUIDE £14.95

DISK INCLUDED FREE WITH THESE
 AMIGA BASIC INSIDE & OUT ... £21.99
 AMIGA GRAPHICS £21.99
 C FOR BEGINNERS £17.95
 DESKTOP VIDEO £18.95
 GRAPHICS INSIDE & OUT £31.95
 MAKING MUSIC ON THE AMIGA .. £27.99
 BEST OF AMIGA TRICKS N TIPS £15.00
 (*SPECIAL PRICE TO CLEAR)

VIDEOS
 DELUXE PAINT 4 VIDEO £14.99
 ADVANCED DELUXE PAINT 4 ... £14.99

BOOK SALE. (Mostly Basic books)
 ELEMENTARY AMIGA BASIC £5.00
 INSIDE AMIGA GRAPHICS £5.00
 1ST BOOK OF THE AMIGA £5.00
 2ND BOOK OF THE AMIGA £5.00

ALL TOP AMIGA MAGAZINES STOCKED
TOP 50 GAMES

- A320 AIRBUS £26.99
- AIRBUS A320 N.AMERICA £27.99
- A TRAIN NEW £26.99
- ANCIENT ART OF WARS IN SKIES £26.99
- ABANDONED PLACES 2 £26.99
- ARCHER MACLEANS POOL £20.99
- AIR SUPPORT £20.99
- ASSASIN £20.99
- BEAVERS £20.99
- BLADE OF DESTINY £30.99
- BIRDS OF PREY £27.99
- BOOY BLOWS £20.99
- B17 FLYING PORTRESS £26.99
- CAMPAIGN £27.99
- CHAOS ENGINE £20.99
- CHAMPIONSHIP MANAGER 92/3 .. £20.99
- CHESSMASTER 2100 £14.99
- CHUCK ROCK 2 £20.99
- CIVILISATION £26.99
- COLOSSUS BRIDGE £20.99
- CREATURES £20.99
- CRAZY CARS III £20.99
- COMBAT AIR PATROL NEW £22.99
- CURSE OF ENCHANTIA £24.99
- D DAY £23.99
- DARKSEED £26.99
- DESERT STRIKE NEW £23.99
- DUNE 2 £23.99
- EPIC £20.99
- EYE OF BEHOLDER 2 £27.99
- FLASHBACK £23.99
- FORMULA 1 GRAND PRIX £26.99
- P15 STRIKE EAGLE II £26.99
- FLIGHT COMMAND £20.99
- FLIGHT SIMULATOR 2 £29.99
- FLT SIM 2 SCENERY DISK. EACH £15.99
- FLT SIM BRIT SCEN COLLECTN .. £36.99
- GRAHAM GOOCH'S WORLD CRICKET £23.99
- GOAL £23.99
- GUNSHIP 2000 £26.99
- GUY SPY £23.99
- HISTORY LINE £26.99
- HUMANS 2 £23.99
- INDIANA JONES FATE OF ATLAN £20.99
- INDIANA JONES -ADVENTURE .. £29.99
- INTERNATL OPEN GOLF (A1200) £20.99
- JIMMY WHITE'S SNOOKER £21.99
- KNIGHTS OF THE SKY £26.99
- LEGEND OF KYRANDIA £25.99
- LEGENDS OF VALOUR £30.99
- LEMMINGS 2 £23.99
- LINKS COURSES £13.99
- MONKEY ISLAND 2 £29.99
- MORPH £20.99
- NICK PALDO'S CHAMPSPH GOLF .. £26.99
- NIGEL MANSSELLS WORLD CHAMP .. £23.99
- PAPERBOY 2 £20.99
- PGA TOUR GOLF £23.99
- POPULOUS 2 PLUS £26.99

ENHANCED 1200 GAMES
 ZOOZ 1200 £20.99
 TROLLS £20.99
 WING COMMANDER £26.99
 SLEEPWALKER 1200 £25.99
 NIGEL MANSSELL1200 £23.99
 ROCCOCO £20.99

MORE AMIGA GAMES ...
 PREMIERE £23.99
 PREMIERE MANAGER £20.99
 PROJECT X £20.99
 RAMPART £18.99
 REACH FOR THE SKIES £23.99
 ROBOSPORT £21.99
 ROME AD'92 £23.99
 SENSIBLE SOCCER 92/93 £18.99
 SIM ANT £25.99
 SIM BARTH £25.99
 SIM LIFE £26.99
 SILENT SERVICE 2 £27.99
 SCABBLE £21.99
 SHADOW OF THE BEAST III £23.99
 SPACE LEGENDS £23.99
 SPORTSMASTERS £23.99
 STREET FIGHTER II £21.99
 SLEEPWALKER £25.99
 STRIKER £20.99
 SHUTTLE £22.99
 SUPERPROG £20.99
 SYNDICATE £27.99
 SWORD OF HONOUR £18.99
 THE MANAGER £18.99
 TRODDERS £18.99
 VIKINGS £25.99
 WALKER £23.99
 WAR IN THE GULF £23.99
 WING COMMANDER £26.99
 WORLD SERIES CRICKET £23.99
 WWF 2 £20.99
 ZOOZ £20.99
 ZOOZ 1200 £20.99

COMPILED
 COMBAT CLASSICS £23.99
 DREAM TEAM £20.99
 LEMMINGS TWIN PACK £22.99
 MEGA SPORTS £18.99
 QUEST & GLORY £23.99
 SIM CITY & POPULOUS £21.99
 SUPERFIGHTERS £20.99

BUDGET AMIGA GAMES FROM £6.99
£4 OFF MOST MEGADRIVE GAMES
 MEGADRIVE CD ROM £264.99
 PC GAMES AT DISCOUNT PRICES

PRICES WERE CORRECT AS OF 29-07-93, but as our crystal ball is broken, some may have changed by the time you read this, due to currency fluctuations & manufacturers/ suppliers price increases. We do make mistakes from time to time too! All registered Trademarks are acknowledged. Callers are most welcome but please phone first to check availability & avoid disappointment - we try to keep most items in stock unlike some of our competitors and will gladly put items aside for you to collect, but shortages of some items do occur from time to time.

AMIGA 1200 WITH HARD DRIVE FITTED

A1200+40MEG HD	£439.99	SPECIAL OFFER	£849.99
A1200+80MEG HD	£499.99		£899.99
A1200+120MEG HD	£599.99		£999.99
A1200+210MEG HD	£699.99		£1099.99

ANY A1200 COMPLETE WITH BATTERY BACKED CLOCK - ADD £20.00

PRICES INCLUDE 2YR EXTENDED WARRANTY

WITH CUBSCAN MONITOR

SAVE £24.
£849.99
£899.99
£999.99
£1099.99

FIT A HARD DRIVE TO YOUR AMIGA 600 OR 1200 - its EASY WITH OUR ILLUSTRATED GUIDE

HURRY - WORLDWIDE STOCKS OF SMALL DRIVES (<120MEG) EXHAUSTED SOON & PRICES WILL RISE.

AMIGA 1200 SUMMER PACK

Inc TROLLS & NIGEL MANSSELLS GP £289.99. (1YR WARRANTY)

40MEG only	£129.99
60MEG only	£174.99
80MEG only	£199.99
120MEG only	£299.99
210MEG only	£399.99

PRICE INCLUDES:

READY FORMATTED & PARTITIONED 2.5" IDE DRIVE; DRIVE CABLE; FULL FITTING INSTRUCTIONS & FIXING SCREWS + LEGAL FORMATTING DISK & RECOVERY HINTS.

FITTED FREE while U wait if you take out an extended warranty at the same time. Otherwise £15.00 fitting charge.

MAILORDER COLLECTION, FITTING & DELIVERY SERVICE JUST £19.99

AMIGA 4000 RANGE

030/040 WITH 80MEG OR 120MEG HDS

PLEASE PHONE FOR LATEST PRICES & SPECS
VORTEX 486 PC CARD £649.99 with any 4000.
(Normally £699.99. 386 card also available)

AMIGA 600
'WILD, WEIRD
WICKED'
£219.99

AMIGA CD32
DUE IN SOON
£289.99

AMIGA 500 CARTOON CLASSICS

> BUILT-IN 3.5" DISK DRIVE
> 1MEG RAM
> MOUSE
> TV MODULATOR
> WORKBENCH 2.04

PLUS
> LEMMINGS
> CAPTAIN PLANET
> THE SIMPSONS
> DELUXE PAINT 3

FEW ONLY
AT
£194.99

FIT A HARD DRIVE YOURSELF - IT'S EASY AND WITH OUR 2 OR 3 YEAR WARRANTY PLANS, YOU'RE COVERED FOR BOTH BREAKDOWNS & ACCIDENTS.

OUR Specially Negotiated LOW COST NO FUSS Warranties cover BOTH COMPUTER & DRIVE FROM ONLY £27.99

- * COMPUTER & DRIVE BOTH COVERED
 - * ACCIDENTS AS WELL AS BREAKDOWNS COVERED
 - * COVERED EVEN IF DRIVE FITTED BY PURCHASER.
 - * COVERED EVEN IF COMPUTER NOT PURCHASED FROM US
 - * VERY FEW EXCLUSIONS
 - * UNDERWRITTEN BY A LEADING UK INSURANCE Co.
- COMPUTERS UPTO £600 - £27.99 for 2yrs or £42.99 for 3yrs.
COMPUTERS UPTO £999 - £32.99 for 2yrs or £67.99 for 3yrs.

Not available for Business users. Exclusions: theft; wilful damage; cosmetic damage - full written details on request. These are Return to Base warranties. Computer must be under 6 months old. Computer value used to calculate warranty cost must include cost of internal hard drive.

WHY NOT COVER YOUR AMIGA 500, 600, 1200 STANDALONE OR 4000 - the prices above apply. Monitors & printers can also be covered - poa.

DON'T BE WITHOUT A WARRANTY.....

Commodore have told us, that their On-site warranty will not apply if the Warranty seals are broken by ANYONE including dealers.

PRINTERS

CITIZEN SWIFT
90 COLOUR
£179.99

9pin; Up to 240cps in high speed draft & 54cps NLO printing speed. 6 NLO built-in fonts. Friction & tractor feeds. Paper park. Low cost ribbons. 2 year warranty. Epson FX850 & IBM Proprinter III emulations. Low noise level, + 'quiet mode'.

CITIZEN SWIFT
240 COLOUR
£284.99

24 pin; 240cps draft & 80 cps letter quality print speed. 9 fonts, 2 scalable fonts. Paper parking, push & pull tractor feed, friction feed. Epson LQ570, NEC P20 & IBM emulations. Ultra low noise level, + quiet mode for even lower noise. 2 year warranty.
128K RAM EXPANSION £33.99

HP DESKJET
550 COLOUR
£679.99

Superb hard to get 300DPI Colour inkjet for laser-like quality. A4 paper size; prints on OHP film & envelopes too.

HP DESKJET 510
£339.99

Superb low cost 300DPI inkjet for laser-like quality. A4 paper size; prints on OHP film & envelopes too.

CITIZEN SWIFT 200
£209.99
COLOUR MODEL
£244.99

24 pin, Very similar to the 240, but slower & fewer fonts. Available in mono or colour versions.
128K RAM EXPANSION £33.99

CITIZEN PROJECT
INKJET
£399.99

300dpi Laser quality 50 nozzle INK jet printer. Fast & very quiet. 360cps draft & 240 cps letter quality print speed. Three letter quality fonts + optional font cards. HP Deskjet Plus emulation. Optional 128k & 256k ram cards. 100 sheet automatic feeder.
Ink cartridges £13.99

SEIKOSHA OP 104
LASER PRINTER
£559.99

Four page per minute; HP Laserjet IIP emulation; 300x300 DPI; 1yr on site warranty.
Postscript version with 2meg ram £849.99

RICOH LP1200
LASER PRINTER
£799.99

6 pages / minute; PCL5 with scalable fonts; upto 400dpi resolution (300 standard, 400 requires extra 2meg ram); 2meg ram as standard; straight paper path; resolution enhancement; flash rom for downloading new firmware; IC card slot for flash roms; serial & parallel ports; 1 yr on-site warranty.

PRINTER ACCESSORIES

AMIGA PRINTER CABLE 1.8m £9.99; 3m £12.99
AMIGA PRINTER CABLE 5m £14.99; 10m £19.99
25way M-M or M-F EXTENSION CABLE 2m £10.99
UNIVERSAL PRINTER STANDS £5.99; & £10.99
RIBBON REINKING SPRAY - BLACK £11.99
SWIFT 1200/9/90/200/240 BLK RIBBON £4.99
SWIFT 9/90/200/240 COLOUR RIBBONS £15.99
PROJECT INK CARTRIDGE £13.99
INKJET REFILL SYRINGES BLCK, 2 POR £14.99
CONTINUOUS LABELS, 1000x1.5"x3.5" £7.99
CONTINUOUS PAPER 60GRM 2000 SHEETS £21.99
2WAY PRINTER SHARER £29.99
3WAY PRINTER SHARER £33.99
4WAY PRINTER SHARER £34.99
For sharing one printer with several computers fitted with 36way sockets - Prices include 2m 36way Printer to switch cable.

STARTER PACK only £4.99. COMPRISES 1.8M printer cable & Driver disk (where available)

AMIGA 1200 UPGRADES

A1200 INTERNAL CLOCK MODULE - £22.99

Plus into internal socket (not fitted to all 1200s) - fitting invalidates warranty. BATTERY BACKED.

AMIGA 1200 FAST RAM CARDS
A1200 PCMCIA 2 MEG 16BIT FAST RAM £149.99
A1200 PCMCIA C 4MEG 16BIT FAST RAM £224.99

AMIGA 1200 32BIT 4MEG + CLOCK £179.99

GVP A1230 TURBO MEMORY BOARDS

Includes 68030 running at 40MHz; 68882 socket for FPU. Has two 32bit simms skts.
With no fpu & 0meg £244.99
WITH 4MEG & 68882 £479.99
WITH 6C81 I/PACK POA
32BIT SIMMS FOR MBI / GVP / A4000 ETC. POA

AMIGA 500 HARD DRIVES

FURTHER REDUCTIONS ON SOME ITEMS

GVP HDB FOR A500 & 500+ - NO DRIVE	£184.99
GVP SERIES II HDB+ 42 Meg for A500 - PRICE DOWN	£244.99
GVP SERIES II HDB+ 80 Meg for A500 - PRICE DOWN	£345.99
GVP SERIES II HDB+ 120meg for A500 - PRICE DOWN	£389.99
GVP SERIES II HDB+ 210meg for A500 - now only	£575.99
The HDB series II can accept either 1 or 2 or 4, 1 meg simms; OR two, 4 meg simms.	
GVP SERIES II HCB for A1500/2000 - NO DRIVE	£119.99
GVP SERIES II HCB + 42meg for A1500/2000	£285.99
GVP SERIES II HCB + 80meg for A1500/2000	£334.99
GVP SERIES II HCB + 120meg for A1500/2000	£409.99
GVP SERIES II HCB + 210meg for A1500/2000	£559.99
The HC 8 Series II can accept upto 8, 1meg x9 Simms in 2 meg steps.	
GVP A530 COMBOS with 42mb drive	£475.99
GVP A530 COMBOS with 80mb drive	£575.99
GVP A530 COMBOS with 120mb drive	£677.99
1MEG *9 SIMMS FOR GVP DRIVES Please note, due to a shortage of 1MEG 32 BIT SIMM..... memory chips & simms, prices are 4MEG x8 SIMMS FOR GVP DRIVES rising daily - please phone 4MEG 32BIT SIMMS FOR A530 .. before ordering.	
A590 & GVP SCSI DRIVE UPGRADES. 42MEG £139.99 EASY TO FIT	

EMULATORS & ACCELERATORS

VORTEX AT ONCE PLUS 286 PC EMULATOR FOR A500	£99.99
GVP PC286 PC EMULATOR CARD FOR SERIES II HARD DRIVES	£99.99
GOLDEN GATE 386SX PC CARD FOR A1500/2000	£399.99
GOLDEN GATE 486SX PC CARD FOR A1500/2000	£699.99
OPTIONAL DRIVE CONTROLLER CHIP FOR GOLDEN GATE	£34.99
11T 80387SX25 CO-PROCESSOR FOR GOLDEN GATE	£89.99
G-FORCE 030/25MHz FOR A1500/2000 others available	£479.99

FULLY COMPATIBLE, WE BELIEVE, WITH ALL AMIGA1200 VIDEO MODES

COLOUR MONITORS

CUBSCAN 14" MULTISYNC COLOUR MONITOR

- * Hi res dot pitch of 0.28mm.
- * Antiglare 14" hi-brightness screen.
- * Digital memory sizing - for automatic borderless display in all Amiga modes.
- * All controls at front.
- * SVGA compatible for PC use.
- * 15-40KHz horizontal scan rate.
- * 45-90Hz vertical scan rate.

THE BEST
NO BLACK BORDERS

NOW ONLY £439.99 INC AMIGA LEAD OR £489.99 WITH SUPERFI 2 STEREO SYSTEM

MONITOR LEADS & ACCESSORIES - LARGE RANGE AVAILABLE.

AL1 - MOST TVs WITH SCART SOCKET TO ALL AMIGAS inc sound lead	£13.99
AL7P CM883/10845 MONITOR TO ALL AMIGAS inc sound lead	£14.99
AL11 9PIN MALE MULTISYNCS LEAD TO ALL AMIGAS	£12.99
AL12 15PIN FEMALE 3ROW Some multisync monitors TO ALL AMIGAS	£14.99
AL13 15PIN MALE 3ROW Some multisync monitors TO ALL AMIGAS	£14.99
PRODUCTIVITY LEAD FOR MULTISYNCS MONITORS	£19.99
MODULATOR EXTENSION LEAD - eliminates modulator overhang	£10.99
MODULATOR SPLITTER - CONNECT MODULATOR & MONITOR AT SAME TIME	£16.99
MONITOR SWIVEL BASE FOR 14" MONITORS & TVs £10.99 HEAVY DUTY	£12.99

MONITOR LEADS MADE TO ORDER - PLEASE PHONE FOR PRICE

A500 MEMORY UPGRADES

A500 / 500+ 1/2meg upgrade without clock	£POA
A500 / 500+ 1/2meg with clock & battery	£POA
A500+ 1MEG UPGRADE	£POA
AMIGA 600 1meg upgrade + clock - now only	£POA

PHILIPS CM8833mk2 ONLY £229.99

COMMODORE 10845 £199.99
> 14" SCREEN
> STEREO SOUND
> RGB & COMPOSITE INPUTS
> ON SITE WARRANTY
> LOTUS TURBO CHALLENGE
> OFFICIAL UK MODEL
> CONNECTING LEAD FREE

COMMODORE 1942

14" DUOSYNC COLOUR MONITOR WITH STEREO SOUND £389.99
COMMODORE 1940 MONITOR £294.99

EXTERNAL DISK DRIVES

ROCLITE RF382av 3.5" EXTERNAL DRIVE £64.99
WITH ANTIVIRUS & ANTI CLICK FEATURES. RRP £79.99
OR WITH NEW XCOPY PRO £94.99
CUMANA CAX354 £64.99

POA - Please phone for price

Slap me krutters and grodge me nurdlers, there's a man over there offering a feast of cut-price software. Is it one of those pirates? No, it's Stephen Bradley...

CHEAP 'N' CHEERFUL

F17

Here on the right, we see the mechanics milking every moment as they attempt a fast and efficient wheel change.

Team 17 ■ £12.99 ■ Needs 1 Meg ■ New!



There's no such thing as a free ride, but Team 17 have come up with a nice cheap one.

There's nothing us reviewers like more than whinging about the price of games, so when a brand-spanking new, more than decent racing game is released for a snip at £12.99, well, it rather takes the wind out of one's sails.

And that's exactly what the Wakefield-based Team 17 programmers have done by releasing *F17* at a budget price in a fit of generosity

not usually associated with Northshire folk. Anyway, if it's that cheap, *F17* must be crap, right? Wrong. What we have here is a perfectly reasonable game released at a perfectly reasonable price. Hurrah.

All this is most commendable, but what do you actually get for your hard-earned brass? Well, *F17* is not going to win any prizes for originality, fitting as it does into the a well-established tradition of racing games such as Nigel Mansell's *World Championship* and *Lotus Turbo Challenge*. But it gives you the impression of belting round various circuits at a fair old speed as you fly past (or into) 2D trackside objects.

To begin at the beginning. An options screen enables you to choose between four cars each of which has different attributes. Red, for example, goes like a bomb in a straight line, whereas Yellow or Green might serve you better on more twisty circuits.



You can then opt to have a bit of practice, take a single race or qualify for the first track of your world championship tour.

There are 16 tracks to be raced, each of which has scenery and a background which is at least appropriate for the venue if not accurate; Monaco, for instance, has plenty of lamp posts and the famous tunnel section.



Encountering the famous tunnels at Monte Carlo is but a dream for us Fiesta owners.

Put your foot down, you'll fall over

Playing the game comes as a rather nice surprise after a long loading time and although *F17* comes on two disks there is hardly any swapping to be done. The first thing you notice about the game is an inability to see very far into the distance and, because it's hard to anticipate bends, an in-game map would have been useful. However,



How can those racing guys concentrate? I'd be looking at all the advertising hoardings...

the car is nicely animated and in serious collisions it can swivel a smooth full circle. Maintenance at the pitlane during the game is, thankfully, no chore, you just pull in and gauge the speed of repairs. However, the pit crew does give the strange impression that they're milking the car.



That Mansell: I weel keel heem

The really great thing about *F17* is that it isn't easy. On Rookie level – the easiest setting – it takes a great deal of practice to win points at each venue, though in time you can usually come first in each race. Even then, two other levels of difficulty, four different cars and the option to play in either normal or arcade modes give it a lasting challenge.

It's fair to point out that if *F17* had been released as a full-priced game, it would not have been rated so highly. However at this price *F17* is good gear. It takes an old concept and uses it to good effect. Let's hope it starts a trend.

8/10

THE ADVENTURES OF ROBIN HOOD

£12.99 ■ Kixx XL ■ (Reviewed AF27 80%)

Adventures in woods are a good thing. And they're even better when you get to don green tights and use words like 'yonder'. Robin Hood has been banished from his castle by Prince John and it's up to you help him regain his rightful position. Gather a band of merry men and generally do good deeds as you explore the forest and interact with people along the way. Not that you have to be nice – you can wander around shooting everything in sight, but you won't top the popularity polls. The isometric 3D perspective works very nicely and the on-screen icons make it easy to control Robin's actions, although he doesn't always do exactly what you expect.



Robin, the hooded man, riding through the glen with his band of merry men. Everything he did, he did it for you.

There isn't a huge amount of depth to the plot and Robin's green tights occasionally blend in with the background so that you lose track entirely of his lower half, but it's in a humorous vein and great fun to play. Get that Bryan Adams record out now!



Never has a man bedecked in green tights done so much for so few. His attributes are there for all to see. The most optimistic, brave villain of them all.

8/10

MIDWINTER II - FLAMES OF FREEDOM

Kixx XL ■ £16.99 ■ Reviewed AF28 87%



Midwinter II is more than a game of two halves so it's worth choosing the attributes of your Field Agent very carefully. This chap is reasonably charming, and very threatening. Nice, huh?

An adventure game for those with the patience of Job, *Flames of Freedom* is something akin to the Milk Tray adverts being transported to the Amiga. The evil Saharan Empire controls all but one Atlantic island and is poised to invade the last remaining island of Agora. You are a special agent with the task of averting this fiendish plot by attempting to liberate others under their control. There are two ways to play: Raid is a short game where you tackle a single island, whereas Campaign is a more involved scenario where you attempt to free as many islands as possible. There is an incredible amount of information to digest but don't let this put you off. *Flames of Freedom* is an excellent mixture of action and adventure

and although it's not graphically stunning, you'll still be playing this when you're in a bath chair.

Just when you think you are on top of a situation, when all seems to be under control, those yellow dots appear.



8/10

SUPER SPACE INVADERS

The Hit Squad ■ £9.99 ■ Reviewed AF29 83%



Whoah! The Cattle Mutilation section. The best bit of the game is when the spaceships hover around then pick up the cows. If you can shoot the ship without hurting the cows, they shout, "Thank you".

Mention this game in the office and you receive a variety of responses. Some say it's completely awful, others claim it's damned good fun. *Super Space Invaders* is a peculiar affair – at times incredibly slow, yet occasionally exciting. Just when you fancy a quick burst of shoot-em-up action, you find yourself firing bullets at four miles per hour. I found the exercise ultimately frustrating. The action was too slow most of the time, though the Cattle Mutilation

sequences saving bovines from marauding spaceships are tremendous.

You can almost smell the chlorine in the sports centre where the machine was. All right, I know – nostalgia isn't what it used to be.

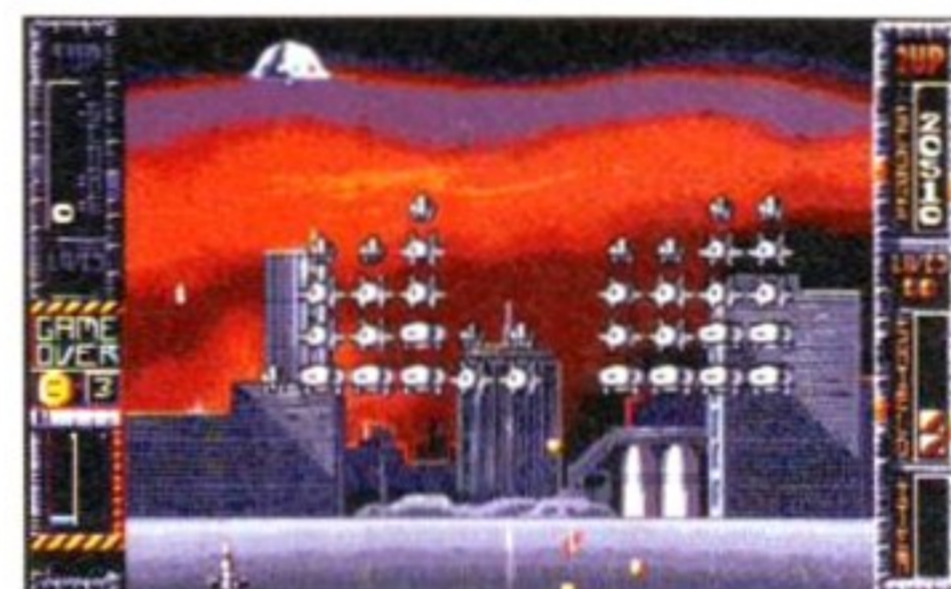

6/10

GRAND PRIX CIRCUIT

Hit Squad ■ £9.99 ■ Reviewed AF2 78%



Admittedly, I've never driven for Williams Renault, but I know when to put my foot down. I refuse to drive for Jenkins Go-carts.

Our recent reader survey revealed that none of our readers have ever driven professionally for a top Formula One team. Obviously aware of this, Hit Squad have re-released *Grand Prix Circuit* four years after its first appearance. Choose from three cars (Ferrari, Williams and McLaren) and race on any one of eight circuits from around the world. The cars are quite tricky to control at first and you may find yourself motoring across the grass on occasions, but persevere (Nigel Mansell did) and victory will be sweet.

Grand Prix Circuit is almost identical to *The Cycles*, a reasonably entertaining motorbike racing game of no fixed address, simply replacing the bikes with cars. There is no wondrous sense of speed, nor are you likely to receive a bottle of champagne. Still, after a couple of bottles of brown ale you may feel the urge to cavort on some Brazilian grass.

7/10

SHADOWLANDS

The Hit Squad ■ £9.99 ■ Reviewed AF33 93%



Wander across desolate plains, while away the hours losing yourself in a maze of passageways and tunnels. Have a fight. The Costa Del Sol is always great at this time of year isn't it?

A tale of discovery, truth and honour. A tale of retribution and vengeance. A tale of clicking a computer mouse around a screen. Legend has it (well, so it says in the manual) that a prince, cruelly slaughtered on the battlefield, returns from beyond the veil of darkness to avenge this terrible wrongdoing.

You are that prince in this isometric 3D role-playing fantasy, and it's up to you to lead a gang back to the Shadowlands to do the business. The warriors all have various attributes and you can control them as a party or split them up, the latter being a vital move to solve some of the rather clever puzzles that block your way as you progress.

With excellent graphic effects and a huge gaming area to explore (including underground passages) *Shadowlands* is an atmospheric RPG and a great buy for less than a tenner.

9/10

CONTACT NUMBERS

Team 17 0924 291867 Kixx XL (021-625 3311) Hit Squad 061-832 6633

YOU DO NOT HAVE TO IMAGINE TO CREATE
YOUR OWN REALITY

REVOLUTIONARY ANIMATION SYSTEM

ADVANCED MODELLING

SUPERIOR RENDERING

REAL3D V.2	RRP	£ 469	Incl.
REAL3D Classic	RRP	£ 99	Incl.

REAL3D is a product of Realsoft OY, Finland.
Marketed by Activa International B.V., P.O. Box 23260, 1100 DT Amsterdam,
Holland, TEL. # 31 20 691 1914 FAX. # 31 20 691 1428, BBS. # 31 20 697 1880

Chart busters

BATTLE ISLE '93

Reviewed AF48 81%
Ubisoft • 081-343 9055



"What's that guy? You can't get through level three? Ah, that'll be yer Lumit stuck in yer Rangg, won't it. Either that or a Karot bunging up yer Sonne. Either way, it's going to cost you."

We've had a lot of letters asking for codes to Blue Byte's latest. I wonder where I put them. Erm, not there. Not there either. Oh, here they are:

ONE PLAYER		TWO PLAYER	
LEVEL	CODE	LEVEL	CODE
0	LUMIT	18	KANTO
1	LUNAR	19	KAROT
2	LUTOF	20	KAISR
3	SONIX	21	SYBIL
4	SOWYN	22	SFINX
5	SOSOO	23	SYNOM
6	SONAF	32	DIONE
7	RACHE		
8	RAMPE	24	LUPOS
9	RANGG	25	SONNE
10	FILMO	26	SOTEX
11	FIEST	27	RASEN
12	FINXT	28	FISCH
13	EBENE	29	EBTON
14	EBSYL	30	KABEL
15	EBONY	31	SYTAX
16	EBTAR	33	NAIAD
17	KARST		

BLADE OF DESTINY

Reviewed AF50 FG91%
US Gold • 021-625 3388

A couple of swift tips from Steve Mann of the US Gold Helpline.

- It's better to have dwarves instead of fighter and rogues, because dwarves can pick locks, and they are very good at fighting.

- A good way of building up Experience is to bust into one of the town leaders' houses three times until you're attacked by the guards - there's only a few of them and they are worth lots of experience points.

LOCOMOTION

Reviewed AF42 19%
DMI • 0753 686000

Aha, the codes for this, er, special game. OK, so it's not very good, but here are the codes anyway. (As if you'd want them - Ed.)



Altogether: "Everybody's doin' a brand new dance now..."

LEVEL	CODE	LEVEL	CODE
B	BEAR	H	HALL
C	CAVE	I	IRON
D	DUCK	J	JEEP
E	EAST	K	KING
F	FIRE	L	LUCK
G	GIRL		

GAME BUSTERS

AIRBUS A320 USA

Reviewed AF49 60%
Thalion • Thalion 021-442 2050

On the A320 USA disk, you will find a small file called "DUMMY". Make a copy of this file, and name it "DUMMY.log". Now, if you sign in giving the name "Dummy", your log book will have on record over 5400 flights and a performance of 500%+.

Colin Beveridge
North Berwick



Colin Beveridge, eh? Good name, that.

MEGA-LO-MANIA

Reviewed AF26 FG91%
Fantastic Worlds compilation UbiSoft • 081-343 9055



I don't think this cheat's quite what Sensible had in mind while writing Mega-Lo-Mania. Still...

At the start of each island, select as many men as you need to conquer the island. Now place your castle on the island in the normal way. Before the screen goes blank and you start the island, make the number of men lower than you had originally chosen. You should now start the island with the number of men you selected at first, but all the men you put back into the "man pool" will be available for other islands in that Epoch.

Peter Crosson
Nantwich

GRAHAM GOOCH'S CRICKET

Reviewed AF47 78%
Audiogenic • 081-424 2244



Use the cheat that Mike Atherton used in the final Test, as provided by Chris Horsnell.

If you're batting, hit the ball and then begin running. Just before the fielder throws the ball, press P to pause the game. Now you will be able to get as many runs as you want, without the fielders batting an eyelid (so to speak). When you get bored press Escape to get back to the game.

Chris Horsnell
Barnsley

ESCAPE FROM COMMODORE

Not reviewed
AF Subscriber Superdisk 50

Here's the complete solution to this PD game, included on the special Subscriber Superdisk (sent free of charge only to subscribers - see page 168) with issue 50.

Go to the software vault, take the Kickstart 4.0 source, then go to the graphics dept. Give Chris the source code. Go to the lobby, and give Fred something to submit to the aquarium. Congratulations!
David Arnholm
Stubbekobing, Denmark

In answer to your question, David - yes, I think it is the first complete solution we've received on a postcard!

FLASHBACK PART 3 - DEATH TOWER

Reviewed AF45 - FG93%
US Gold ● 021-625 3388

Welcome to part three of the Flashback solution, where we show you how to get through the Death Tower game. This is Normal level, as opposed to Easy level (which is for amateurs...)

LEVEL 8 Go right and kill the terminator (1). Open the door, go back to the right, and recharge your shield. Go left, kill the terminators (2 and 3), then proceed left. Open the door, and take the lift up.

LEVEL 7 Jump up, then go left and up. Open the floor trap (4), go left, and kill the terminator (5). Activate the doors, and kill the terminators (6 and 7). Go left and up, then continue left and kill the terminator and the two floating balls (8). Go left, use the Save post (9), then go left and take the lift up.

LEVEL 6 Open the door (10), and roll left past the trap (11). Climb up and go left. Watch out for the trap door, and recharge your shield (12). Go left, kill the terminator (13). Proceed left, watching out for the floor mines, then take the lift up.

LEVEL 5 Roll left, and kill the terminator and the floating ball (14). Climb up, roll right, then save. Go left then climb down. From the centre platform run left, jump up by running left and holding down the fire button only, then continue left. Kill the terminators (16 and 17), jump over the pits, continue left, then take the lift up.

LEVEL 4 Go right, release the terminator by flicking switch (18), and kill him. Open the door using the switch, and jump up by running right and holding down the fire button only, then go right. Kill the terminators (19), then recharge. Watch out for the big drop, though - dangle down first. On the lower platform, go right and open the door using switch (20). Go back, and on the middle platform go right and open the floor trap using switch (21). On the lower platform go right and take the lift up.

LEVEL 3 Shoot the three terminators, then go right and up. Kill the middle floating ball, kill the terminator, and use the save post (22). Kill the remaining three balls, then take the lift up.

LEVEL 2 Kill the terminator (23), open the door, then kill the other terminator (24). Take the lift up.

LEVEL 1 Kill the last terminator (25), and wait for your prize!

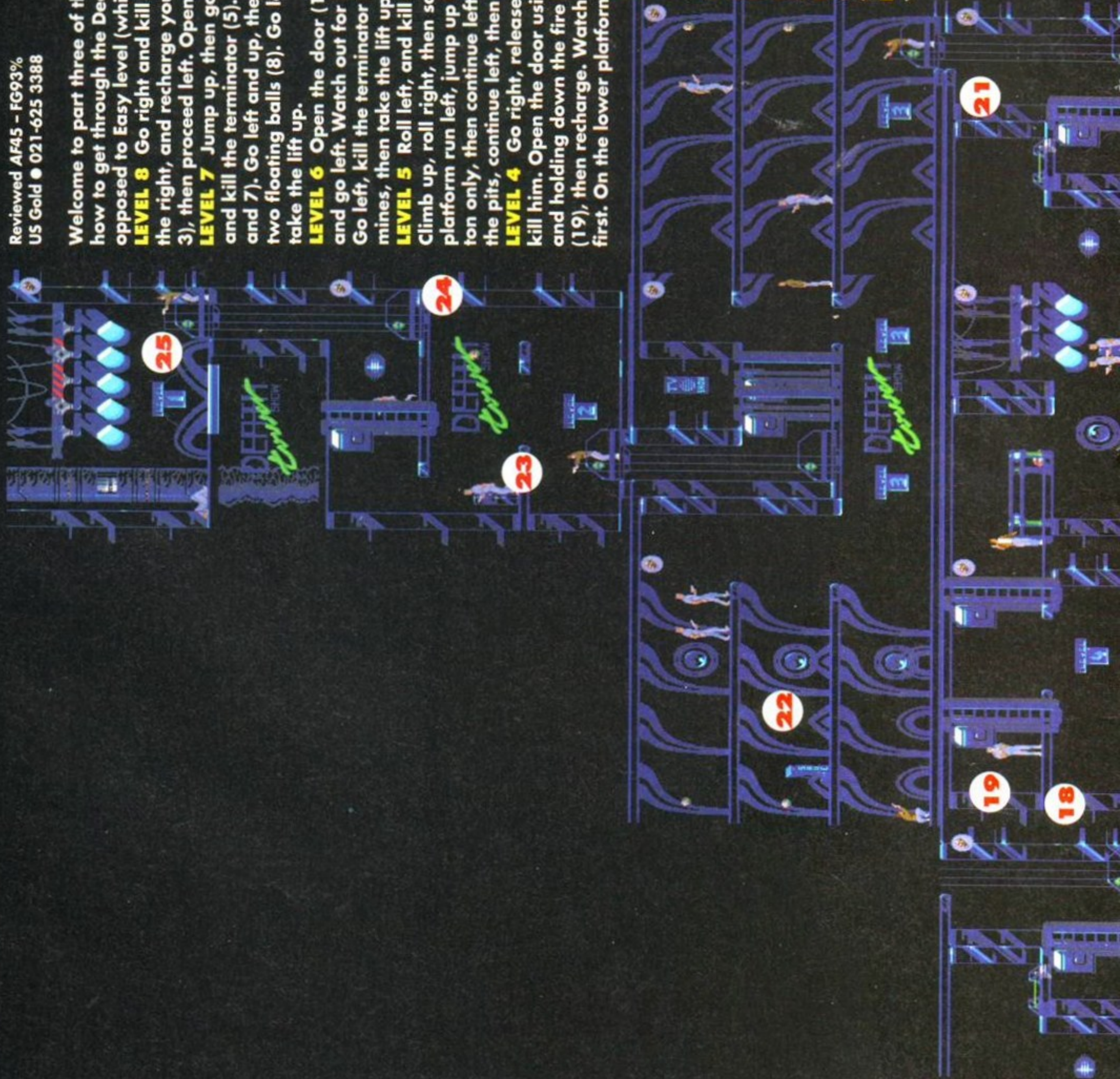



DUNE II

Got Ordos on your mind? Harkonnens stuck in your hair? Or Atreides in, um, your trousers? Follow our tip-top tips for the top in Virgin's super strategy game.



Build a repair facility, buy a couple of carryalls, and you won't worry about damaged units again.

Reviewed AF50 FG90%
Virgin Games 081-960 2255

SPECIAL TACTICS

- Always defend your base well with the best possible units. Until defensive turrets become available leave units on guard, never send them all out at the same time. Later on in the game, a group of well-placed rocket turrets will leave you free to concentrate on attacking. (Always place rocket turrets on the edge of the base so they don't interfere with future buildings.)
- Don't forget to attack! The enemy will often send a constant stream of units at you but it is important to build up a force and take a shot at the enemy base instead of just defending your own. You can often find the enemy base by following his units back there.
- On the later levels build a Starport. This is a very important building to own since it enables you to buy units from The Merchant's Guild for anything up to half the price it costs to build them! Keep checking for bargains, because the prices change every time you look.



Buying machinery from Dune dealers can be limited. Building a Starport will give you access to dealers all over the universe.

- If you have a Heavy Factory or a Starport, either build or order a few extra Harvesters. This way you only need to build one Spice Refinery. You should have about three Harvesters to maximise spice production. Don't forget to build Spice Silos as the spice can build up quickly.
- If you are short on credits, sometimes you don't even need to build factories because the Starport will provide everything, usually at a cheaper price. The down side, however, is that the Starport can run out of stock, which can be inconvenient.
- A Repair Facility is almost essential once they become available. Carry-alls can bring damaged units to them and take them back to the battlefield.
- If you capture enemy factories you can build their special units such as The Deviator, The Devastator and The Sonic Tank.



The enemy won't normally attack until they've set up camp themselves, sometimes they will do a kamikaze trip though, so watch out!

- Watch out for sneak attacks especially near the start of a level. Your first encounter with an enemy

house will often be when they airlift troops near your base in a Carry-all. The troops can appear on any side of the base so make sure all sides are guarded. After that you can concentrate your defences on the side of your base which faces the enemy one.

- Your most important building is the Construction Yard (see Attack Plan). On the later levels the enemy will sometimes try to concentrate their attack on it and Death Hands are frequently aimed at it. If it is destroyed you can no longer build any new buildings, so guard it well. If you are unlucky and lose it, order or build a Mobile Construction Facility and deploy it where the Construction Yard used to be.



Because your construction Site is very fragile, a mobile version will be available (at an inflated price, naturally). Buy one as soon as you can.

- The Spice Refinery is another important building. If it is destroyed when you are low on credits then you won't be able to rebuild it because of the lack of money and you will not be able to refine Spice to earn credits. In this dire situation, your base will eventually be destroyed, unless you have almost finished the level.
- On the last two levels you will be allowed to build a House Palace. This can only be built once you have a Starport. It is very expensive (999 Credits) but is extremely well armoured and is free to repair. It also gives you access to your House's Special Palace Ability (Fremen, Saboteur or Death Hand.)

To Be Continued next month...
Thanks to Gregg Spivey of Welwyn Garden City, who wins a £50 Mail Order voucher for these tips.

HOORAY, IT'S THE RETURN OF THE... PATHETIC TIPS

This tip, from Craig Poxon (!) of Westcliff-on-Sea, requires the Coverdisk from Amiga Format 50 - the Deluxe Music Construction Set 2 demo.



Play tunes just like Rolf did while you were a nipper. Unless you're a nipper...
"Place the mouse pointer over the piano keyboard, and hold down the left mouse button. Now rapidly move the mouse backwards and forwards, keeping within the highest and lowest notes. Hey Presto! An instant 'Rolf Harris' Stylophone' simulator just like I used to have when I was a nipper!" Yeah, cheers Craig - we can rest safe in our beds tonight now.

Taking the biscuit, as it were, is a reader from Southend: "Load up any version of *Deluxe Paint*, then right click on the Fonts icon. A requester should appear, but instead of typing in a font directory type ':IAMSUPERMAN' with no spaces. Now a game should appear on the screen." The guy's name? U B Nad. No we haven't, matey!



Clicking on the Fonts icon in *Deluxe Paint* would be easy if there was one!

FLASHBACK

Reviewed AF45 FG93%
Delphine/US Gold ● 021-625 3388



No need to bang your head against the wall any more. With this cheat you can actually walk through them!

A small cheat to get through any wall or door, even when it's closed. Simply walk up to the wall (or door) and turn around so that your back is against it. Hold down the fire button, and tap the joystick in the way that you are facing, then pull the joystick in the opposite direction and press fire. He will then carry on through the wall or door.
Neil Evans and Mark, er, 'Gerbil' Stott, Witney and Oldham, respectively.

BULK DISKS



**MAIL ORDER DISK SUPPLIERS
WHOLESALE & RETAIL**

100% certified fully guaranteed

DS/DD 3.5 BULK DISKS

50	£20	+	£3	p&p
100	£36	+	£3	p&p
250	£85	+	£4	p&p
500	£160	+	£5	p&p

Same day despatch on orders received before 3.00 pm

**9 High Street South
Olney, Bucks MK46 4AA**

Tel: 0234 240954

Fax: 0234 240272

**10 DS/DD
PLANET
BRANDED DISKS
supplied in
QUALITY
plastic flip top
library case with
labels
ONLY
£5.99 inc p&p**

**Enquire for bulk
prices**

TEQUE LONDON LTD

**BRUTAL SPORTS FOOTBALL - Millennium
F1 RACING - Domark SHADOWWORLDS - Krisalis**

Teque are established developers of high quality games on Sega, Nintendo, Amiga and PC. As part of our continuing expansion, we are looking for experienced and newly qualified staff to join us in our London offices:-

PROGRAMMERS

You will be highly skilled in assembly language programming (eg 68000, 80x86, Z80 etc). You will have a demo of your work on disk, which shows your potential as a games programmer.

ARTISTS

You will have a good portfolio of your own original and imaginative graphics on computer. You will be eager to work on the latest consoles and games.

JOBS

Positions are all full-time in-house at our London offices. Salary and bonuses are dependent on age and experience and are very competitive.

For more information contact Tony Love or Barry Costas on **081 983 4147**, or FAX us your CV on **081 983 3812**, or write to us (enclosing CV and demo disk) at:-

**Teque London Ltd, Teque House, 83
Coborn Road, Bow, London, E3 2DB**

**We are also interested in evaluating original
Amiga, ST and PC games.**



**Menace, Blood Money, Lemmings, Lemmings 2,
Walker, Hired Guns**

DMA Design is the name behind these great products. We are now looking for new names to join the team behind DMA.

PROGRAMMERS

Our first priority is always Gameplay. Your first priority is an active interest in computer and video games, a degree in a related field would be helpful - and if you have relevant experience then all the better.

ARTISTS

GAMES DESIGNERS

In return for your enthusiasm and commitment we can offer interesting work on 16 and 32 bit platforms (PC, 3DO, Mac, SNES, MD), excellent development facilities, a competitive salary and a relocation to beautiful Scotland.

Send your CV, including a paragraph on how you think you can help add to DMA's success, to me, Simon Little at DMA Design, Discovery House, Dundee Technology Park, Dundee DD2 1TY

Artists and Game Designers should include as many examples of their work (Disk, Video or Paper) as possible.

Now is your chance to help redefine the standards in video games!

HELPING HAND

Are you still stuck on Level 2 of *Blab the Unloved*? Well it's just as well Andy Nuttall's here to help you with more of those hard-to-beat Amiga games

FLASHBACK BOGUS SHOCK!

When I bought and loaded *Flashback*, I went to the password screen and typed in one of the passwords from the Cheat Compendium (*Amiga Format* issue 49). It didn't work. I checked, and the same codes appeared in most of the mags I could find in my local Smiths. As usual, *Amiga Format* bounced back into my good books with the correct codes. Where on earth did the bogus codes come from?

Ian J Forest
Rochdale

It turns out, after some intensive investigation by your roving reporter, that the 'bogus' codes were actually from the French version of the game, which was released earlier than the British version, and so made many trips over the channel before the official release.

Some magazines in this country printed those codes to claim a first, little realising that they were providing a useful service for those criminally suspect people who had pirated the game from the French version. Shameful.

HOLE IN MY SHADOW



Good wholesome stuff is this *Shadowlands* game thing. A whole lot of fun too.

I'm stuck on level nine in *Shadowlands*. There are two holes blocking the doors to level 10, and I have no idea how to move them or make them disappear. Please help.

Paul Netherthon
Deal

You need to cast a light over the holes, and they will then disappear. Domark have a helpline for their games old and new, why not try calling 081 780 2224 for more help.



This game was based on a film that never existed. A shame *Escape to Victory* wasn't.

INDY AND THE MAGIC LAMP

Help! I'm having difficulties with *Indy Jones and the Fate of Atlantis*. I've distracted Sternhart to pick up the kerosene lamp, but I can go no further into the temple. Also, where do I find the Bead of Orichalcum which I need to trade with Costa?

Mark Bloomfield
Colchester

Go into the temple, open the kerosene lamp and use the kerosene on the spiral shapes to clean them up. Now take the spiral shapes out of the wall and use them on the elephant's head to get the Bead of Orichalcum. Easy, eh?

DIZZY, DIZZY BEE!



Doric columns or is that Corinthian? Whatever it is they've all got growths. Classicism? Pah!

Dizzy's giving me the needle. On level 2 of *Crystal Kingdom Dizzy*, what do the large sheet, the needle and the thread do? Where do I use them?

Peter Beeston
Workshop

The answer lies in the deflated boat. Take the needle, the thread and the sheet to the boat and patch it up. When you inflate the boat, it will now stay blown up.

TOKI CHEATS

I can only get to the third stage of *Toki*. Do you have a cheat to help me make stage four?

Paul McCormick
Paderborn
Germany

Yep, simply type in KILLER while playing the game. This will provide you with infinite lives, and you can also use F1-F6 to skip levels.

TURTLE RECALL

Greetings! I'm having trouble with *Teenage Mutant Hero Turtles*. Will



This game was based in a film that really shouldn't have happened. Groody to the max!

you give me a cheat for this game?

Anonymous
Portugal

When you're asked for the security code, type in 8859, then 1506 for the second attempt. Now type in the correct number, and you can press the Help key to get infinite lives.

SISTERLY ADVICE

I know that *The Great Giana Sisters* is an old game, but I can't complete it. Do you have any cheats?

Darren McCormick
Paderborn
Germany

Start the game, then hold down the A, R, M, I and N keys to skip levels.

SEVENTH HEAVEN



Dune 2 was actually written by David Lynch and a small baby ocelot with spikey hair and plies.

Can somebody help me with *Dune 2*? I've been on it for weeks now, and I just can't get off level 7. Please help, I'm tearing my hair out trying to do it.

Brian Hargrave
Sunderland

Well, I've got to admit that level 7's a toughie. Took me a long time to complete that one you know. Unfortunately, I can't really give you much help, though, because it's just a case of plugging away at it until you get a lucky break. Make sure that you build up a fighting force as early as possible, then move out as many as possible to defeat the enemy (preferably before he begins attacking you). Concentrate on his manufacturing plant, then once you've destroyed that you have the edge. Also, remember to build as

many gun/rocket turrets as possible, as well as or instead of walls. If you have enough of these you shouldn't be too bothered by enemy Ornithopters. Good luck!

WIZARD WEAPONS

I would be grateful if you could give me cheats for *Lethal Weapon* and *Wizkid*, both by Ocean.

Gary Armstrong
Luton

To skip to a desired level in *Lethal Weapon*, simply hold down the Alt and F keys, then press the number on the numeric keypad which corresponds to the level required. *Wizkid*, though, I'm not too sure about. Does anybody out there have a cheat?

DUNE TIPS

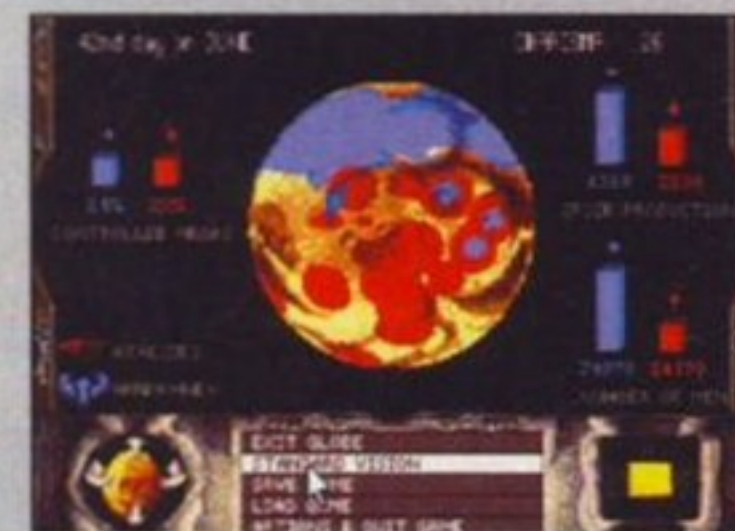

Frank Herbert eh? Silly name. Might as well have called himself Benny Bumhead. Pah!

Help! I'm stuck on *Dune* (the first one). I need a lot of tips, beginning to end. Please help me!

C Bond
London

I'd love to be more helpful than I'm going to have to be, but... could you perhaps be more specific, C?

MUSIC TO YOUR EARS

I'm having difficulty with *Turrican 2* - I can't get any further than stage 3. Do you have a cheat?

Carey J Webb
Burnham-on-Chouch

Well, let's see. If you access the Music menu (by pressing Help while on the title screen), then type in 142 and press Escape twice, you will be indestructible.

SEND US YOUR STUFF

If you're having trouble with a particular game or have a solution to a letter printed in the magazine, don't keep it to yourself - write it down and send it to us, and we'll do our best to print it. Send it to:
HELPING HAND
Amiga Format, 30 Monmouth Street, Bath BA1 2BW.

F-117A™

The Definitive Simulation of America's Radar Elusive Jet

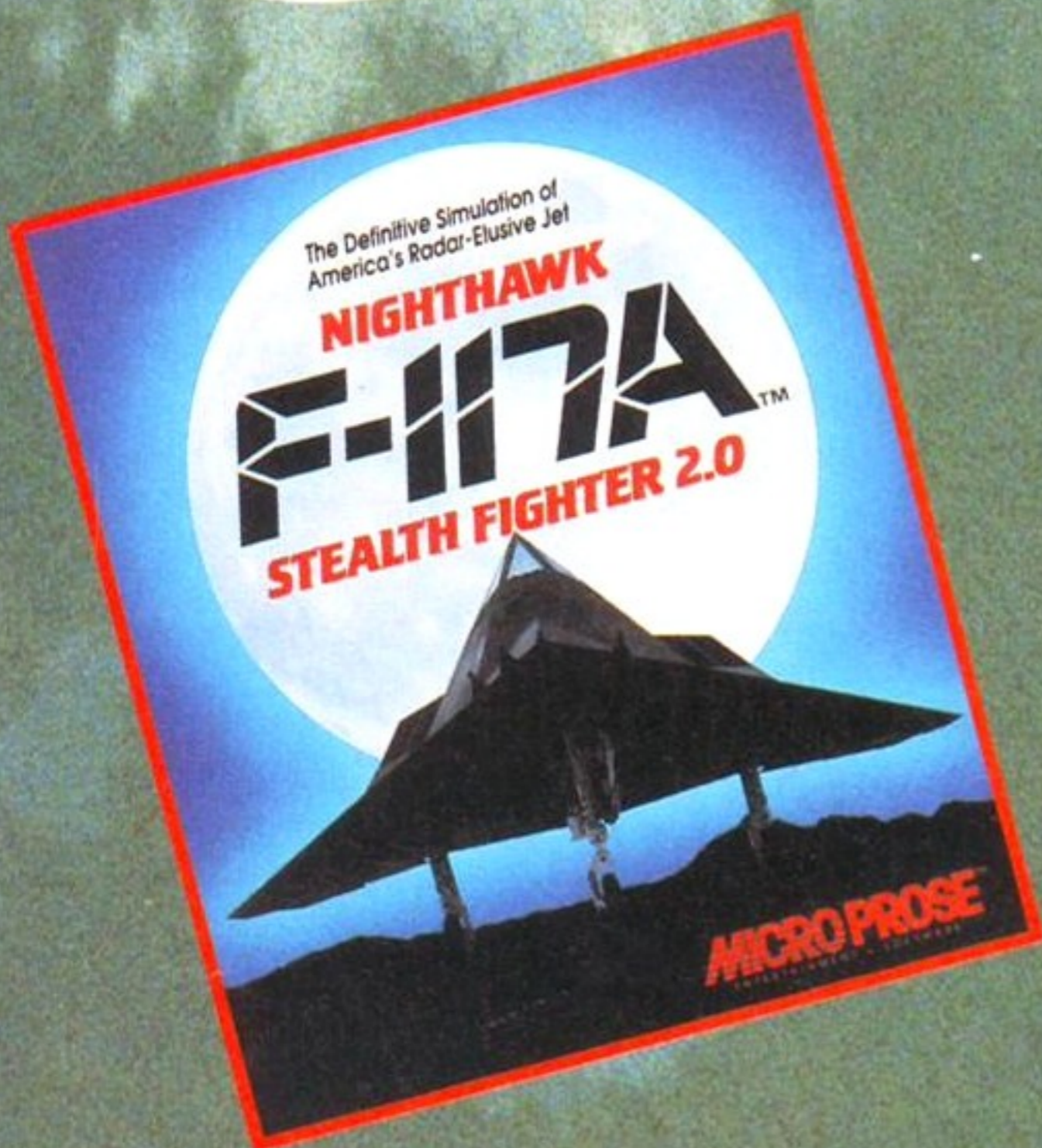
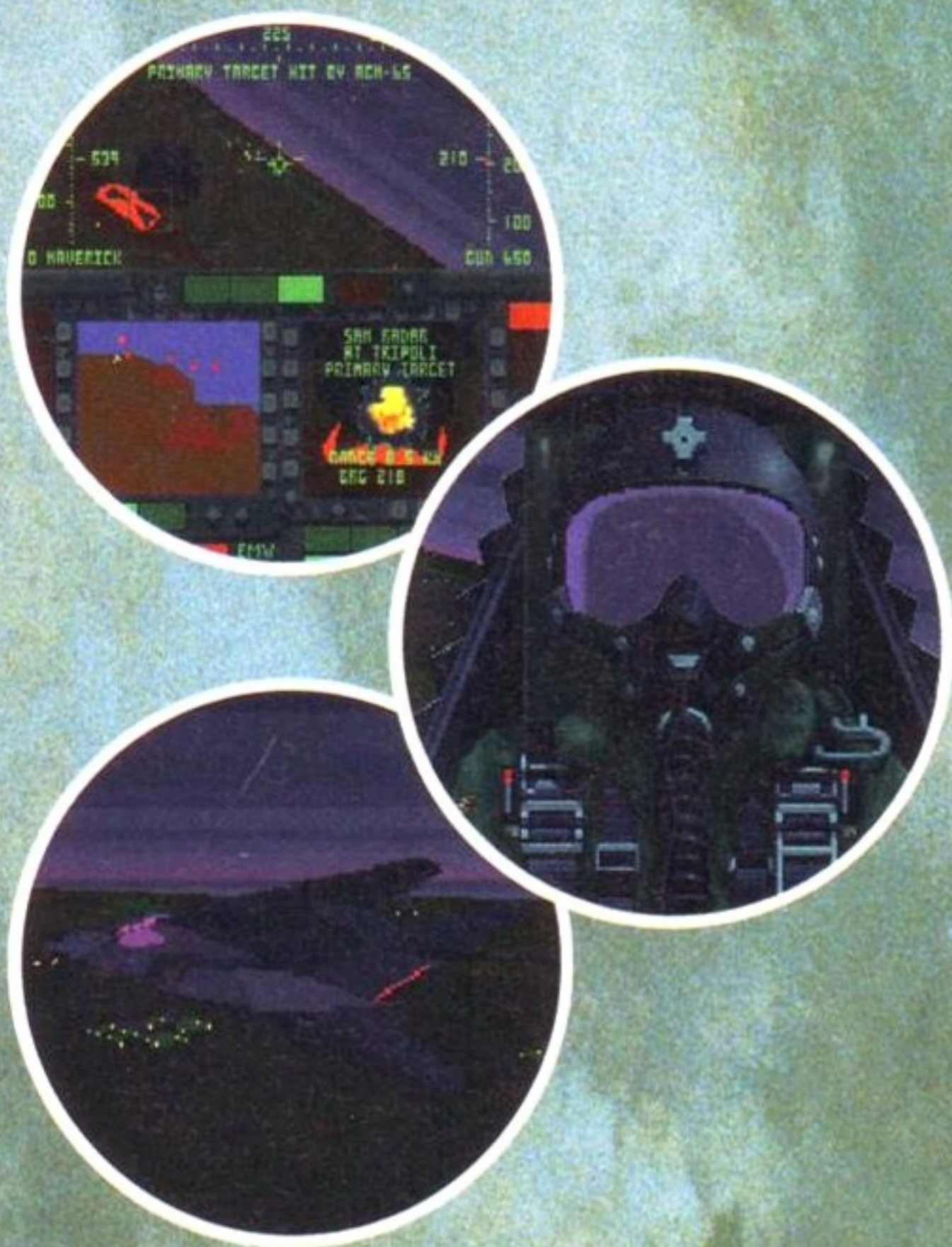

A shadowy, gleaming craft steals through the night sky. Out of sight but never out of mind. Sleek. Slicing through the dark.

No blips register on the radar. No sign is given.

Then, in an instant, an explosion bursts through the murky twilight and, as quickly as it appeared, the Nighthawk melts back into the shadows.

The F-117A has carried out another stealth mission.

MicroProse present the definitive simulation of the world's most elusive jet: the F-117A.

Now with eye-popping graphics, sensational sound, thrilling music and a vast array of awesome missions across NINE of the world's 'hot-spots'. Catch it if you can!

F-117A Nighthawk Stealth Fighter 2.0

*Unprecedented, uncompromising
and undetected.*

MICRO PROSE®
Seriously Fun Software

MicroProse Ltd., The Ridge, Chipping Sodbury,
Avon BS17 6AY. Tel: 0666 504399

Available for IBM PC Compatibles and
NOW for Commodore Amiga

WIN TWO AMIGAS

By now you should have ripped the Blitz Basic 2 Coverdisk off the front of this month's issue and be holding it in your sweaty palm. What are you going to do with it?

You could play the superb version of Defender, or you might have a go at the gorefest which is *Zombie Apocalypse*. On the other hand you may fancy winning yourself an Amiga 4000/030.

Acid Software, programmers of Blitz Basic, and Amiga Format are offering two of these fabulous machines to the lucky winners of this great programming competition.

All you have to do is write a game, or any other kind of program in Blitz Basic 2, using either the version on this month's Coverdisk or the full package (available on page 151 at the special price of £49.95).

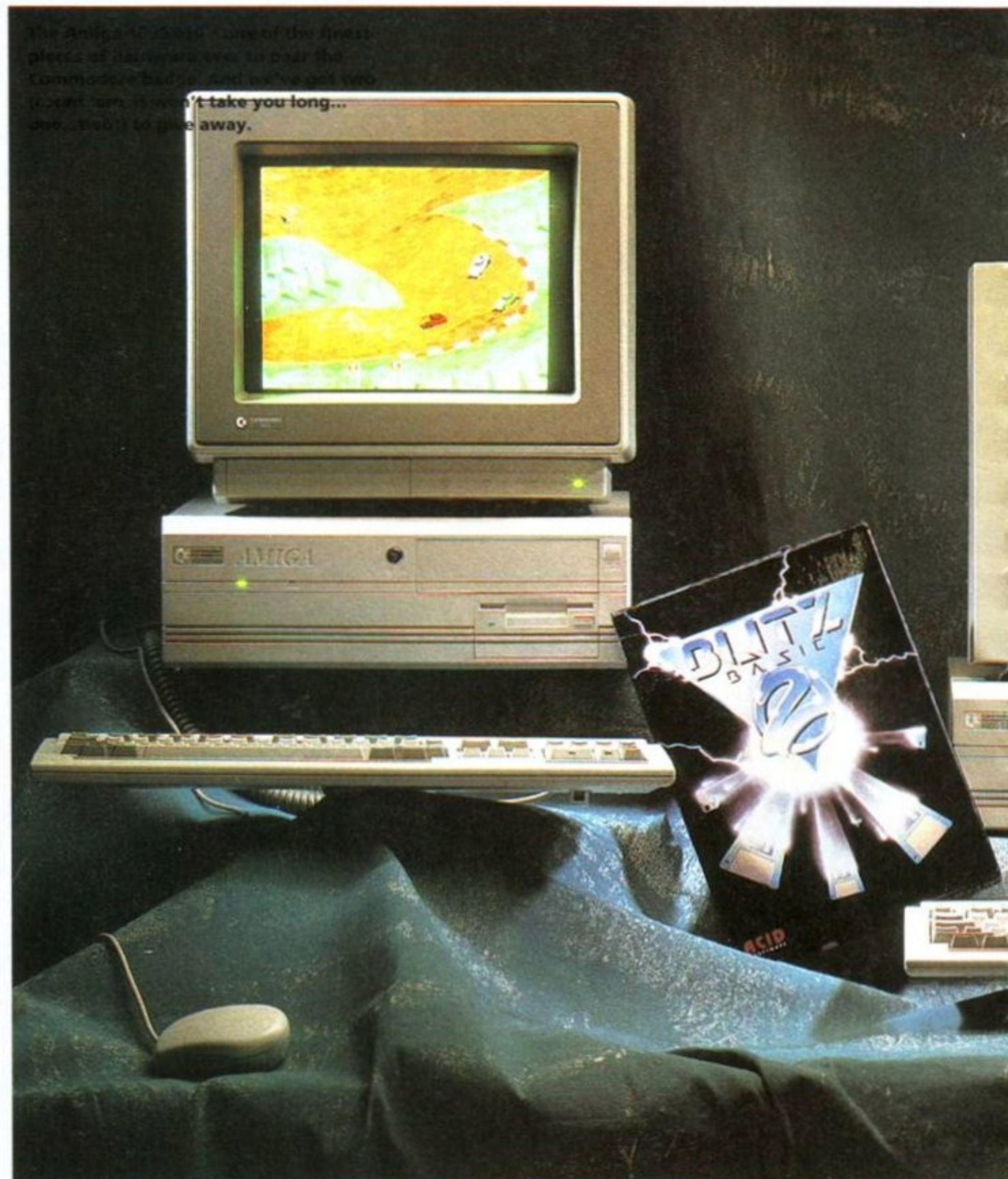

OVER £2000 WORTH OF

We don't care! We don't care whether it's a game or a serious program that is. *Blitz Basic 2* has more than proven its games writing abilities. But its power with the intuition libraries makes it more than a match for any other package when it comes to writing spreadsheets and databases too. So we're not telling you what to write, that's up to you.

We're not asking you to be original either. After all, *Defender*, *Zombie Apocalypse* and *Skidmarks* are hardly revolutionary in design terms. What they are though is highly-playable, highly-addictive classics. So if you choose to rip off *Tempest* or *Mr. Do!* we won't go getting

upset about it. All we're asking you to do is write a game that makes us find it difficult to put our joysticks down. A tall order, to be sure. We are wizened, jaded and hardened games-playing professionals, after all!

But get cracking, read the tutorials in this and future issues of *Amiga Format*, and write yourself a program. If it's one of the best two we receive, you'll find yourself the lucky (and skilled) owner of a brand spanking new Amiga 4000/030.

The winner will also achieve fame and fortune as the star programmer of an *Amiga Format* Coverdisk program. We'll put your game (or a cut down demo) on a

future issue's Coverdisk. The copyright of the game will remain with you, and so you will be able to collect all the shareware fees.

If you do as well as Bryan Bell did with his *Charlie Chimp* game, you'll be laughing all the way to the bank, and we'll all be looking on jealously...

If you feel the need for the extra features of the full *Blitz Basic 2* to help you create your programming masterpiece, you can buy this powerful package (worth £69.95) at the bargain price of just £49.95. Turn to page 151 now and find out more about this fabulous deal. ☺

AMIGA 4000s



The more than slightly excellent *Skidmarks* allows up to four players to battle it out on the dirt track, bump bumpers and generally do driving things. The full game will be commercially released soon, and will feature monster trucks and loads of other goodies. If you haven't played our Coverdisk version yet, get a friend and give it a go. It's completely addictive and it was written completely in *Blitz Basic 2*.



Defender, responsible for more missed lessons in everyone's 'A' levels than the underage serving habits of their local landlords. Probably the greatest arcade shoot-em-up of all time, *Defender* had never been adequately re-created on a home computer until Mark Sibly got out his copy of *Blitz Basic*. If you haven't played it yet, it's on this month's Coverdisk.

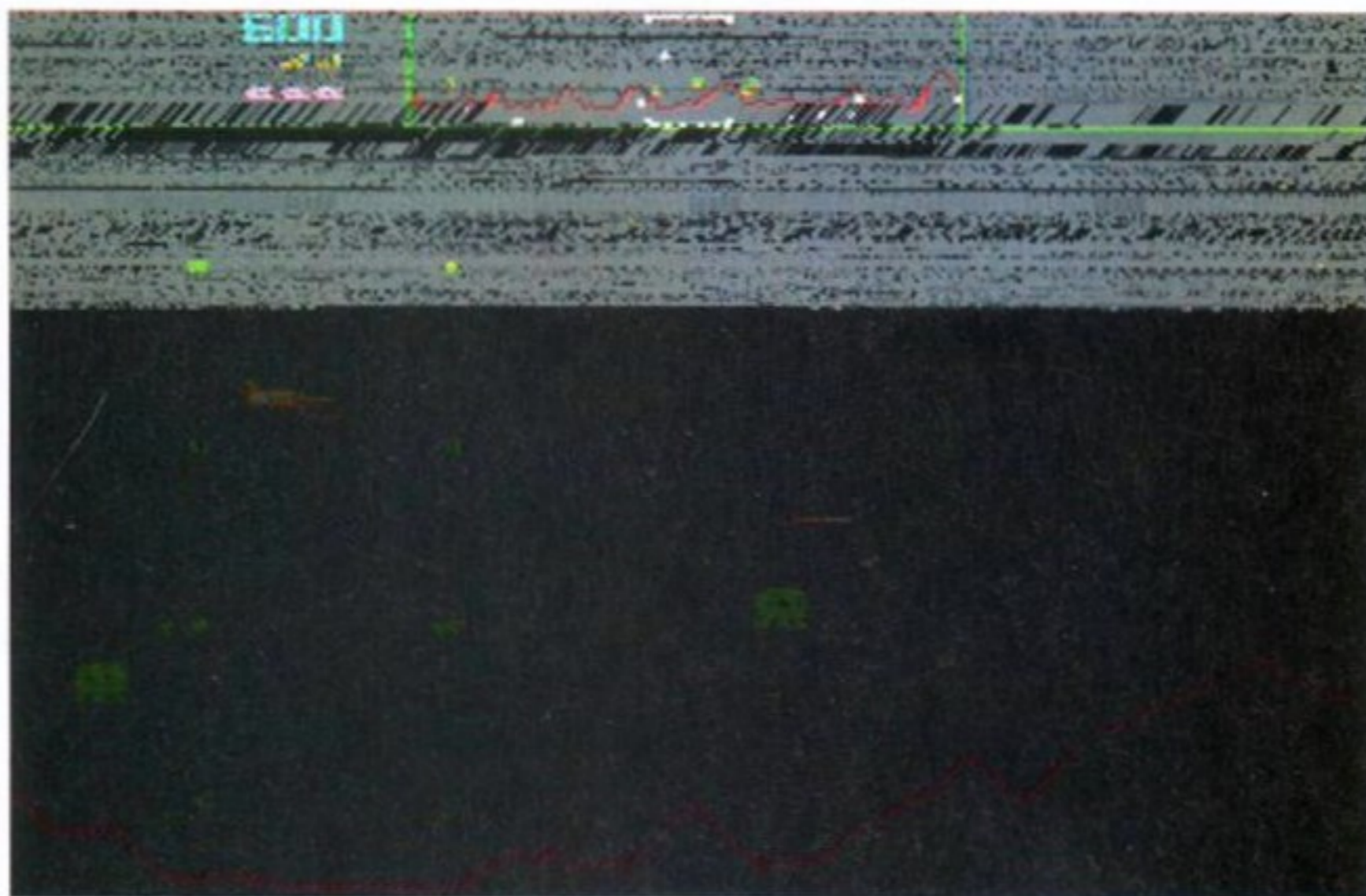

PRIZES UP FOR GRABS

OBEY THESE RULES!

1. Employees of Future Publishing, Vision and Acid Software may not enter.
2. Mark Sibly definitely can't enter.
3. All entries must be received on 3.5 inch AmigaDOS disk before 31.1.1994.
4. Amiga Format reserves the right to place the winning entry on the *Amiga Format* Coverdisk, but not if it's crap. Then again, if it's crap, it won't win.
5. Copyright remains with all entrants, so even if we put it on the disk, it remains your property, and you can collect the shareware fees and retire.
6. Erm... that's it.

Zombie Apocalypse. Written in *Blitz Basic* (but then what did you expect us to say?) Zombs, as we've come to affectionately know it, is a bit of a gorefest. In fact we have chosen to give it a 15 certificate on this month's disk label, just to be topical and cause controversy. This fast action packed shoot-em-up may be a little shallow, but it's loads a fun. And it really shows what you can achieve very easily with *Blitz Basic 2*.



Amiga Format and Future Entertainment Show Get creative competition

The second Future Entertainment Show

This is your final chance to get creative and win some fabulous prizes. So don't put it off any longer - get your entries in now!

Over the years the Amiga has grown into an extremely sophisticated machine. Not just as a games machine, or solely for serious use, but the Amiga is now a capable performer in many areas. At creating gorgeous graphics, the Amiga is master, with programs like *Deluxe Paint*, *Imagine* and *VistaPro*. And Desktop publishing is a doddle with *PageStream* and *ProPage*. With its ability to play sampled sounds and run a wide variety of music programs, the Amiga is also a powerful music machine. And Editing and titling videos is another skill the Amiga is adept at.

Because of these plentiful and wondrous abilities, we've put together a mega huge competition with prizes that represent the variety of operations the Amiga is used for. And the different things you have

to do to win the prizes means that everyone has a good chance of winning a prize they can really make the most of!

Each of the prize winners will have their prizes presented to them at the Future Entertainment Show on 11-14 November. (But don't worry if you win and you're not there, your prize will be sent to you. But you would be mad to miss it.)

This year the FES promises to be even bigger and better, with 150 exhibitors covering around 20,000 square feet of the Olympia Exhibition Centre. More than 60,000 people are expected to attend the show, and tickets priced at £6.95 or £24.95 for a group of four, must be booked prior to the show.

A credit card hotline has been set up for the show, so to book your tickets call 051-356 5085.

WIN! AN AMIGA 1200

IN OUR EXCELLENT DESIGN-A GAME COMPETITION



Happy families in 'Hodjasville' - a grand line up ready for you to decide which characteristics they'll have. That's if you can design a brilliant game.

Following the completion of *Second Samurai*, Vivid Image are about to embark on their most ambitious project to date. *Hodja* is to be a CD-only game, developed for every CD platform, and Vivid Image want you to design it for them!

This isn't just the Vivid Image boys being lazy - they've done the preliminary work on the game, like designing the characters in the story and the basic scenarios, and what you have to do is come up with a design for the game itself.

The story so far...

Hodja is a Turkish folk hero, believed to have lived around the 13th century. His name means 'the wisest of men' and he makes his living by telling funny stories, making predictions and giving advice to people. Because what he says is completely made up and untrue, most of his pre-

dictions go wrong, so he can't stay in one place too long.

A typical suburban family, whose name you must make up, hires Hodja for a birthday party. What the parents don't realise is that Hodja practices real magic, but he's not very good at it. He grants the child a wish, which he must ask for while blowing out the candles on his birthday cake. The lights go out, the boy blows out the candles, and when the lights come back on, the family is sitting in a strange, monster-filled fantasy world. One of Hodja's spells has backfired... again!

Here's where you come in!

Design a game continuing on from the above story. To help you, Bill Hajee (who animated the mice in the Disney film *The Rescuers*) has drawn a rough of what the family look like - see the

cartoon. He will also be working on the in-game graphics, so don't worry if you can't draw!

Make your design in full storyboard-type form if you can, with detailed pictures describing each of the areas of the game, and some brief text to describe them. However, if your drawing is not so hot you can just sketch out the scenes, and write down descriptions of the levels.

The game design must be appealing to the whole family. Because a family is portrayed in the game, a real family should be able to control the characters. Up to four players may play the game simultaneously, with each playing the part of a family member. There should be an option to switch to anyone at any point in the game.

A family pet could be included, either a cat or a dog, which would either help or hinder the family's efforts. Alternatively, a baby monster could be befriended by one of the children during the adventure. Oh, and not forgetting, of course, Hodja's beloved donkey, Eshek.

Each member of the family should have different objects (which they were carrying prior to the casting of the spell), which they can use to get rid of the monsters they meet. Also, since the physical attributes of the characters vary, so must their abilities.

To avoid patronising the characters, you should introduce humour and role-reversal. For instance, the father may be terrified of snakes, while the mother may find them cute. Remember that *Hodja* is to be for CD-based machines only, so there are no limitations for the game's size and scope. Think of it as an interactive mini-movie, but steer clear of the all graphics and no gameplay type of game. Try to make it easy to play and combine adventure with arcade sequences and puzzles. Above all, have fun!

THE PRIZES AND HOW TO ENTER

Send your entries in by 8 October 1993 to:
Write a Vivid Game Competition, Amiga Format,
Future Publishing, 30 Monmouth Street, Bath BA1 2BW.
Your entries must either be as a full script with
sketches or a full storyboard. The entries will be judged

by Vivid Image.
The main prize for the best game design will be a
shiny new A1200! And Commodore have given us an
Amiga CD32 to give away as a runner-up prize - so, get
your thinking hat on, and go for it!



3 Panasonic PRINTERS

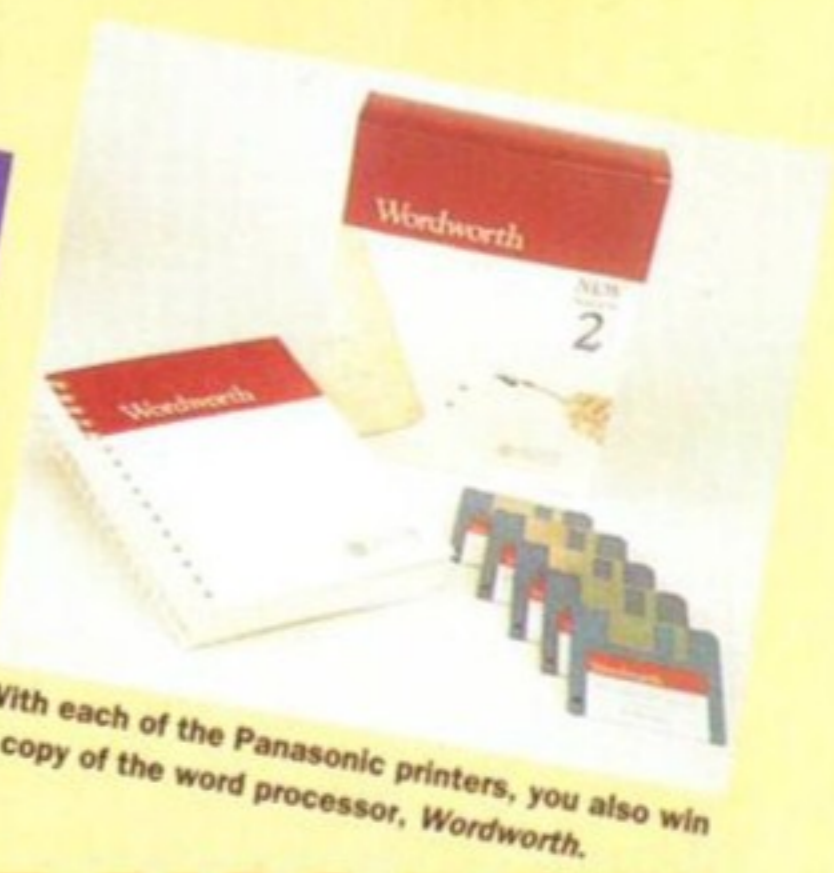

With each of the Panasonic printers, you also win a copy of the word processor, Wordworth.

AND WORDSWORTH UP FOR GRABS

Whatever you're using your Amiga for, whether it is simply word processing and writing letters, or complex graphics and illustrations, you will need some type of output device. That's why we've got together with leading mail order company, Indi Direct Mail, to offer you the chance to win one of three high quality printers from Panasonic.

With each of the three Panasonic printers we're also giving away a copy of Digita's excellent word processor *Wordworth*, worth £129.99.

Indi are offering a Panasonic KXP-4410 laser printer as first prize. Worth £499.99, it can handle complex graphic applications, has low running costs, and prints up to five pages a minute. Second prize is a Panasonic KXP-2123 24-pin Quiet colour printer worth £239.99, and third prize is a Panasonic KX-P2180 9-pin colour Quiet printer worth £189.99. Both high performers, they use Quiet printing technology and have fast printing speeds.

ANSWER THESE QUESTIONS:

- 1 How many fonts are there on a Panasonic KX-P4410 laser printer?
- 2 How old are you?
- 3 What are the print speeds of the Panasonic KX-P2123 Quiet colour printer?
- 4 What computer/s do you own?
- 5 What is the sound level of the Panasonic KX-P2180 Quiet colour printer?
- 6 What will your next computer-related purchase be? (A clue: the answers to questions 1,3 and 5 are on the Indi advertisement.)

TIE BREAKER:

I think Indi is the number one choice for computer products because _____

(In no more than 15 words)

Send your answers, and your name and address and phone number on a postcard or the back of a sealed envelope to:

Indi Printers Compo, Amiga Format, Future Publishing, 30 Monmouth Street, Bath, Avon BA1 2BW.

TO ARRIVE NO LATER THAN 8 OCTOBER 1993

WIN! A VIDEOPILOT



With Videopilot you can cut and edit your videos with professional results.

If you win this competition you can turn your Amiga into a multimedia machine with this excellent video editing suite from V3i. Plugging into your Amiga's serial port, and controlling up to three source decks and one single destina-

tion deck at a time, the Videopilot enables you to cut and edit your videos to achieve more professional results.

Because we know that anyone interested in winning a Videopilot will be a dab hand

with their camcorders (or are working on it), to win this competition you have to make a video recording.

Now we're not fussy - the subject matter is completely up to you - it can be humorous, thrilling, horror, a music video or a recording of everyday life. What we do want is originality and style. But what we don't want is your original and only copy of your recording - if it gets lost or damaged in the post you will have lost it for good.

Send your entries, and your name, address and phone number on a postcard or the back of a sealed envelope to: Creative Film Compo, Amiga Format, Future Publishing, 30 Monmouth Street, Bath, Avon BA1 2BW.

WORTH £1,300!

WIN A DAY IN A TOP RECORDING STUDIO!

If you've ever thought about creating music on your Amiga, then now's the time to do something about it! You could win a full 12 hours in a professional recording studio, to record your music using a full set of professional gear, with a recording engineer thrown in to help you out with the difficult bits.

The studio is Heritage Studios in Huntingdon, owned by percussionist Evelyn Glennie and engineer Greg Malcangi. It features 20-bit

digital recording, 48 channel MIDI, and samplers, effects units and keyboards. And at the heart of the studio is an A4000/040 running the *Bars & Pipes Pro 2* sequencing program.

The winner and runner-up of this competition will also receive a copy of *Bars & Pipes Professional 2*, rated FG90 per cent in issue 46, so the total value of the prize is... oh, huge. So what are you waiting for? Get your entries in now!

HOW TO ENTER

All you have to do to win this competition is create a piece of music using your Amiga. This could be using a full-blown MIDI set-up, or a simple tracker program (such as *ProTracker* featured on the *Coverdisk of Amiga Format 48*).

When you have created your piece, record it either to ordinary cassette or DAT, and send it to: Get Creative Studio Comp, Deborah Thackery-Tyres,

Heritage Studios, Heritage House, Main Street, Upton, Huntingdon PE17 5YF.

The entries will be judged by a panel including Evelyn Glennie, Greg Malcangi, and a Commodore representative.

Please supply a list of all the equipment you have used to create your piece. And don't send an original master of your music, because it cannot be returned to you.

YOUR ENTRY MUST BE IN BY 8 OCTOBER 1993

BRILLIANCE

THERE ARE TWO things that have already made the Amiga 1200 and A4000 a success. The first is the fact that they are top-notch, state-of-the-art 32-bit machines, and the other is the AGA chip set. Who could resist the 16-million colour palette? Not me, that's for sure.

The program that most people thought would be best placed to make use of the new graphics capabilities was the AGA version of *Deluxe Paint*. After all, it has been the favoured paint program for most situations for quite some time. However, when came out a big problem cropped up.

Sure, all the tools are there, but *DPaint* AGA is so slow. Now Digital Creations (the brains behind the highly acclaimed DCTV system) have pitched their attempt into the AGA paint market with *Brilliance*.

The Brilliance package consists of not one but two programs: *Brilliance* and *TrueBrilliance*. The first is what's termed a register-based program, which means that it works in the normal Amiga colour modes (two to 256). *TrueBrilliance* is used for manipulating HAM images and can also handle 24-bit images in HAM mode.

Splitting the package into two separate parts means that none of the features have to be scrimped on to make everything fit. If you need to use special HAM tools, then you use the HAM-specific program rather than making do with inappropriate tools designed for fewer colours.

Whichever version of the program you use, you really need 4Mb or more of RAM to make the most of it. It will run in two, but you are rather limited as to what size of file you can play with, especially in HAM-8 mode. Keep this in mind when getting into graphics on your AGA machine: all those colours need a lot of memory!

The appearance of *Brilliance* makes a move away from the usual *DPaint* look-alikes, being more akin to professional art

The AGA chip set in the new Amigas is exactly what you want for creating superb graphics. And now Maff Evans uncovers the perfect paint package to make use of it...

MAIN PICTURE: This composite image shows how the tools in *Brilliance* can give an enormous range of effects, working in anything from 256 to 260,000 colours!



packages. This is because there are no pull-down menus to search through when you need an option. Instead, each area of the program has its own dedicated control panel that can be called up from the main menu, so all the options and tools you need for one job are in one place.

This makes a refreshing change and makes the whole thing a lot easier to learn. In fact - I never thought I'd say this! - it makes even *Deluxe Paint* look cumbersome. Anyway, enough of the cosmetics, what of the features?

Working in *Brilliance* falls into three main areas - painting, brush manipulation and animation - so let's take 'em in turn.

Painting

The paint tools are organised extremely sensibly. Instead of having separate menu items for empty or filled shapes, both are on the same button. If you want to draw a filled rectangle instead of an empty one, just click twice on the rectangle gadget.

If you want to access options linked with a tool, you just click on its icon with the right-hand button to call up a special control panel. Very easy. This means you can get straight in, rather than having to learn loads of icons before you start.

As well as painting with straight colours, there are a number of special paint modes that you can access. These include all the usual smear, smooth and cycle effects along with a few specialities.

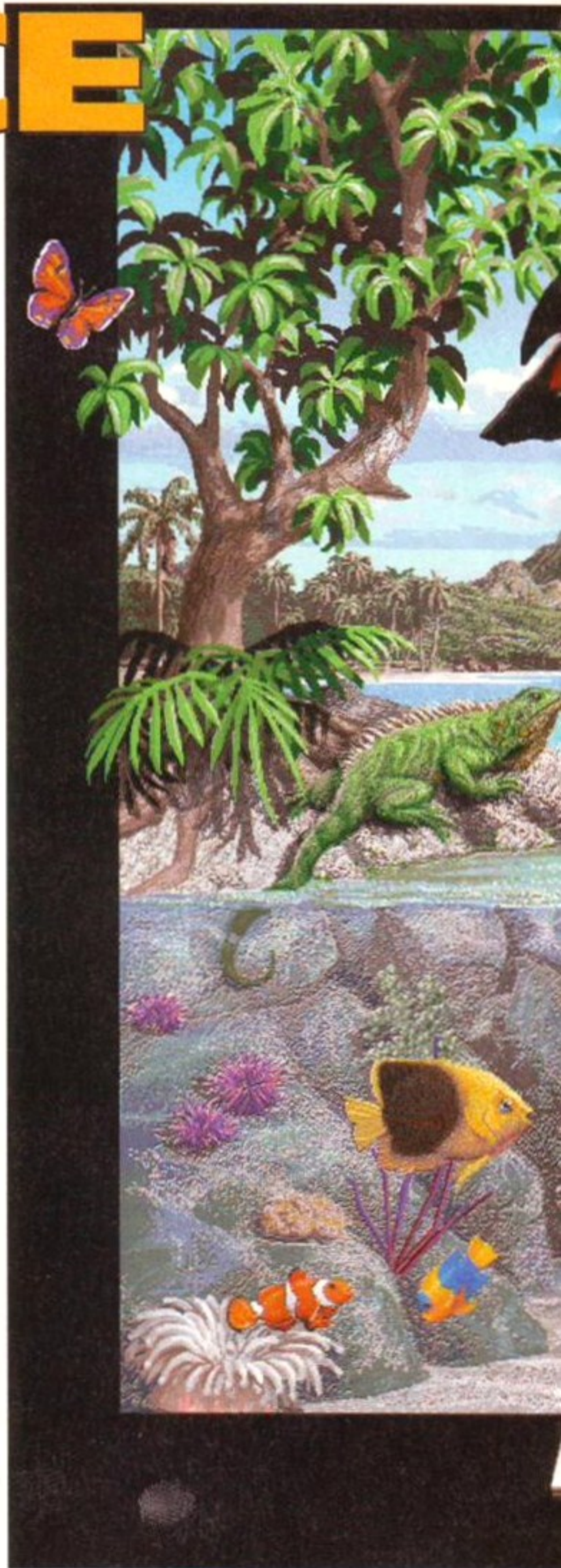

Look into the glass orb

Using one of the sample pictures included with the package, here is a do-it-yourself example of how *Brilliance's* excellent gradient fills and Transparency mode work in practice.

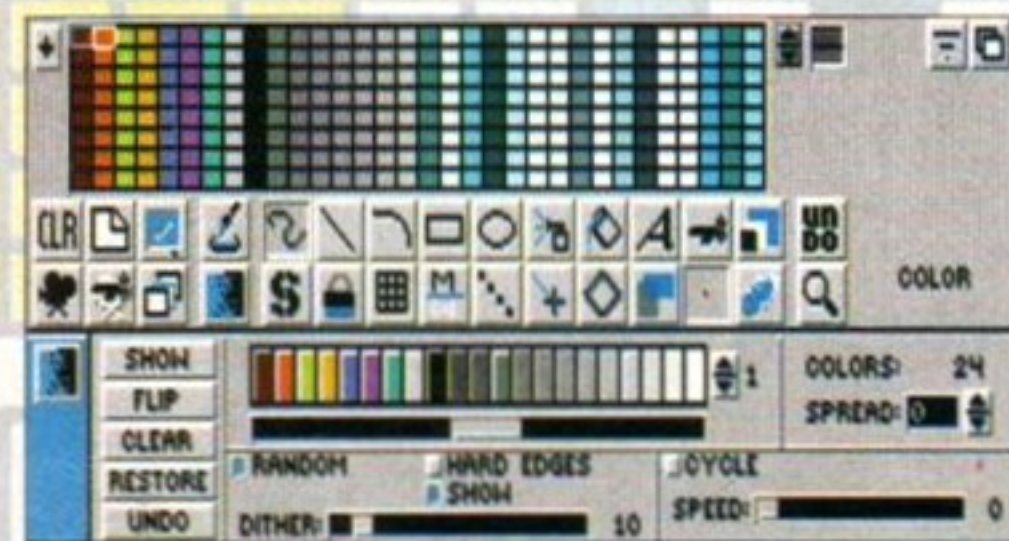

1 Load up the Lagoon picture and go into the Edit Palette screen. Set up a spread of shades of grey over a range of about 32 colours, then transfer the spread into the range requester.

2 Select the filled ellipse tool, enter the brush mode panel and choose the Highlight option. Now open the Transparency window and make sure it will act on RGB values at about 50%.

3 Now just draw a circle by holding the left button and dragging the mouse with the Ctrl key held down (this constrains the ellipse to a circle). And that's it! A simple way of drawing glass spheres on a picture.



The Tint function works a lot better than its *DPaint* counterpart (it's available even when using filled shapes, rather than just in freehand or airbrush modes), the Brighten and Darken functions work to a variable amount (specified by moving a slider) and Average Smear (equivalent to *DPaint's* Blend) works much more smoothly, blending colours in sweeps rather than spurts as *DPaint* AGA does.

Along with the impressive drawing functions, *Brilliance* also boasts a wide range of gradient fills for drawing solid shapes. The colour gradients are defined in a very flexible editor. Not only can you simply drag the pointer across the window to enter complete ranges from the palette, you can also enter double-markers for abrupt changes in gradients, have different gradients for each drawing screen and set the program to calculate inbetween shades so that your fills are as smooth as possible.

The fill types on offer are horizontal, vertical and angled gradients, highlight fills, spherical fills and radials (which are concentric rings that always emanate from the centre point). These can all be set to 'fit' in to an awkward shape, so that the gradient flows smoothly right across an area. Using these fills, you can create very solid-looking objects – especially when you use a lot of shades in a colour range.

Unfortunately, there isn't a rub-through function (which would help you to blend another image into your painting, giving an effect like painting on glass) but there is another method which can be used to similar effect.

Any drawing mode in *Brilliance* can be applied using the Transparency function. This causes the image being drawn (whether it's a filled shape, a freehand line or a custom brush) to appear translucent. With careful use, this can be every bit as

effective as rub-through. By mapping a map of the world onto a sphere, picking it up as a brush and stamping it down on another picture using Transparency, I managed to create a very effective glass globe effect in next to no time.

Quite a few packages have many of these effects, but *Brilliance* has an edge due to the sheer speed with which it carries them out. Gradient fills are calculated and drawn in a few seconds, no matter how many colours you use. No longer do we have to start a fill then go off and have a cup of tea while the Amiga works it out.

Brush manipulation

Picking up and using brushes in *Brilliance* works in a very similar way to *DPaint*. You select the brush-cut option, draw around the area you want to cut and that's it.

Brilliance goes a bit further than that, though. You can then use the Transparency mode to get a rub-through effect, as described above, as well as go through all the usual bending and twisting effects or use it for four types of pattern fill: tile patterns, horizontal stretch-fitting, shape contours and perspective.

There is a range of functions for fine-tuning the control of brushes either when picking them up or using them: Auto Background looks at the colours in the four corners of a brush and sets that as the transparent background, Tile Cut removes the right and bottom lines of a brush (so

☛ *Brilliance* has an edge due to the sheer speed with which it carries operations out. No longer do we have to start a fill then go off and make a cup of tea while the Amiga works it out... ☛

that pasting brushes next to each other doesn't cause an overlap) and Align enables you to reposition a brush relative to its original screen position (useful for creating smooth pattern fills).

You can also remap the colours in a brush, copy its palette to the main screen palette or switch the position of the brush's handle.

One particularly useful option is the ability to store eight brushes. This really comes into play when 'morphing' brushes. By going to the Animbrush panel, setting the number of frames and then choosing which of the two brushes you want to morph together, you can create transformations from one brush to another.

The results of morphing vary, depending on the number of colours in the palette and the amount of antialias used, but on the whole the effect is very good.

Alongside the eight brush storage 'wells', there is a function for storing and retrieving brushes from the Amiga's clipboard, so that you can transfer brushes between *Brilliance* and *TrueBrilliance* without having to save them to disk.

The control over Animbrushes is remarkable. Not only can you set the number of frames to pick up and the direction to use, you can actually force an animbrush to fit into an animation of different

Continued overleaf ▶

THE MAIN MENU, AND WHAT IT OFFERS...

General controls include load/save of files, screen mode, and setting for types of animation.

The palette of 256 colours, with up and down arrows on the right to scroll through. New colours are picked with a dropper from a colour square on a panel which pops up when you click on the icon below.

These buttons control the clever system of pop-up panels used instead of menus to select tools.

The upper of these two buttons brings up the palette; the lower one activates colour cycling or pops up the gradient menu.

The special tools are stencil, lock background, grid lock, mirror, segmented draw, anti-aliasing, transparency, the pen tip (brush) size, and draw mode.

The standard drawing tools are much as you would expect - freehand draw, straight line, curves, shapes, airbrush, fill, text, brush cut-out and brush distort, plus undo and magnify.

The on-line help facility is on all the time and tells you what the button or tool under the pointer is for.

length automatically. Just set the number of frames in the Fit section and *Brilliance* will automatically add or delete frames in the Animbrush to keep the animation as smooth as possible. No more messing around pasting double-copies of frames and picking the brush up again to get the Animbrush to the right length. Excellent!

Animation

Most of the animation options in *Brilliance* are controlled using the Tween page. This acts similarly to *DPaint's* Move page, with figures being entered to make a brush move up, down, in or out of the screen or rotate around three axes. *Brilliance* enables you to create a path by setting a start and end point or by defining how far a brush should move.

Extra effects, such as ease in and out, trails and fades can also be done from here, as can perspective effects. To keep things simple, *Brilliance* uses the values from the Tween page for all the program's perspective drawing functions, so you only have to enter one set of values.

If you don't like the sound of this numbers lark, don't worry. You can set up animations by stamping the brush down on the screen and copying the information into the Tween page. All you have to do is click on the Adjust button and the panel is replaced by a requester showing the data from the Tween page and some controls. You just select the data you want to edit, click on the screen, drag the mouse and the data will be transferred automatically.

Control over playing and editing animations is provided in the animation page, which looks like a video editor. Finding a particular frame is just a matter of moving a slider - it really is that easy.

The magnify mode zooms right in so that you can see individual pixels. The degree of zoom in or out can be controlled with the buttons on the bar at the left of the magnify window.

If you want to create cartoon animation, with animated figures moving across a background rather than static shapes spinning and sliding across the screen, you can use Animbrushes in conjunction with the Tween page. This enables you to set paths for your characters without having to stamp down each frame in an Animbrush separately (which can be difficult, especially since *Brilliance* doesn't have a light-table feature).

Control over playing back and editing animations is provided in the Animation page, which is laid out like a video editor. Here you can choose the length of an

animation, cut out or add sections, set the speed of playback and determine the way the animation will be played (forwards, backwards, looped or 'ping-ponged' back and forth). Finding a particular frame in an animation is just a matter of moving the slider - it really is that simple. In fact, anyone who has a video will be able to use it.

As you've probably worked out for yourself, *Brilliance* is loaded with useful drawing and animation features, but it's not just the sheer number of tools on offer that impresses. Two other big points arise.

First, the program is very easy to use, thanks to its intuitive, flexible and well thought-out panel system. You just call up the panels you need and put them away when you've finished with them. It's great being able to have the colour palette, the range requester and the fill-type screen open and editable at the same time.

The second major factor is *Brilliance's* speed. Even in HAM-8 mode, everything zips along beautifully quickly.

You could put *Brilliance* up against any of the other art packages in its price range and on features alone it would easily hold its own, but with all three factors together (tools, ease of use and speed), you're unlikely to find anything as impressive on any machine. At getting on for 200 quid it is hardly cheap, but when you consider what you get it looks great value.

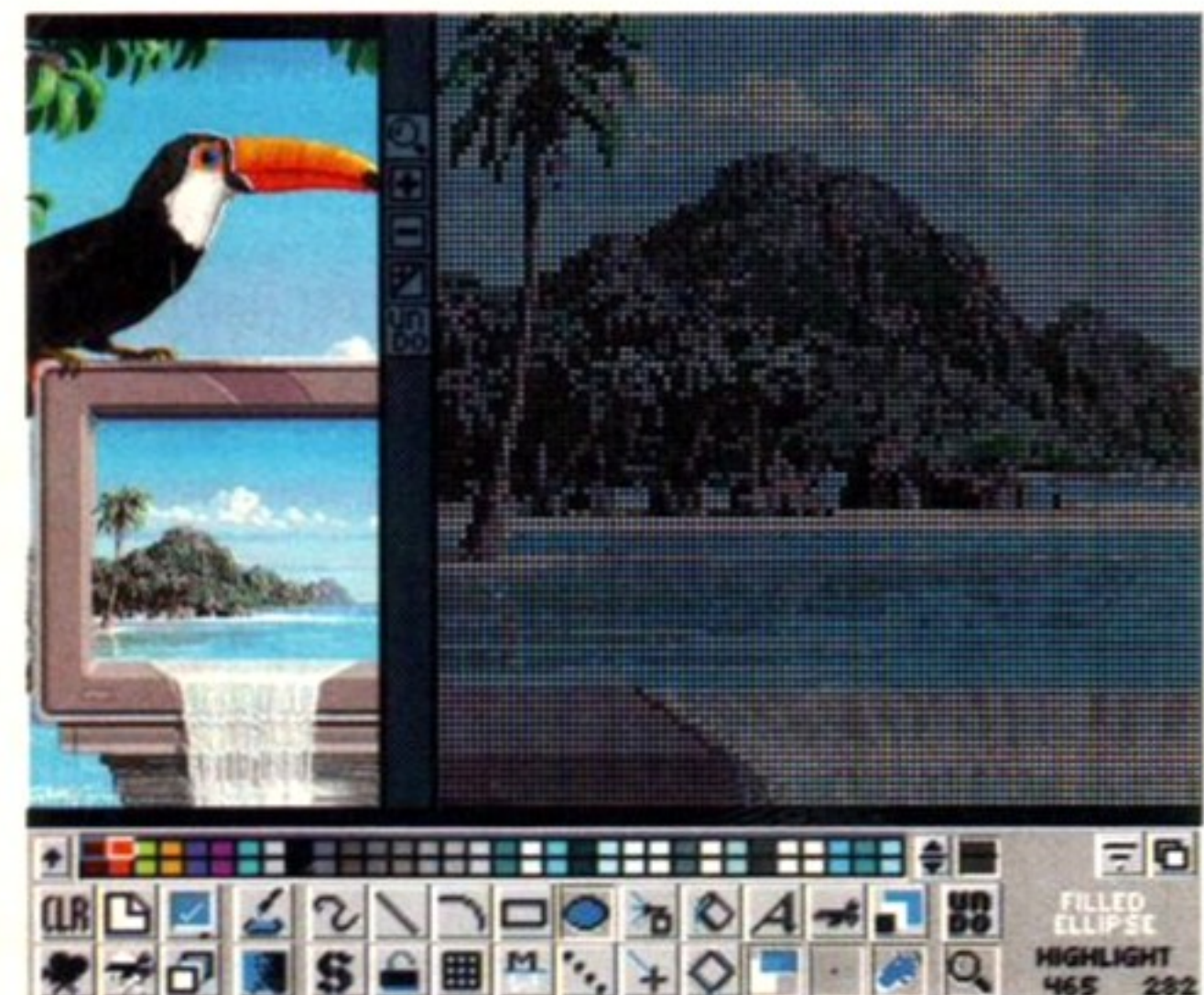

BRILLIANCE

DESCRIPTION
Paint and animation package

MANUFACTURER
Digital Creations

DISTRIBUTOR
All good retailers

PRICE
£195 RRP or less

RELEASE
Available now

SPEED ●●●●●
Streets ahead of *DPaint* and many other packages in most operations.

MANUAL ●●●●●
Well written with clear descriptions and tutorials to get you started.

ACCESSIBILITY ●●●●●
The odd tool needs a bit of manual reading, but mostly pretty intuitive.

FEATURES ●●●●●
Perfect, except rub-through and light table would have been useful.

VALUE ●●●●●
A lot of dosh and you need a RAM expansion, but you get so much!

VERDICT

Can handle anything *DPaint* AGA can do but much, much quicker. At nearly £200 it may seem expensive, but it's worth it. Probably the best paint package at the price on any type of computer.

92%

PYRAMID

Presents...

LEISURE SEGA C.D. COMPETITION



SKILL CHALLENGE

COMPLETE IN INK, USING BLOCK CAPITALS

1. Fill in the missing word
SEGA **GEAR**
2. What is the first level of Sonic the Hedgehog?
3. Name the letters on the Sega Joypad

TIE BREAKER
Complete in no more than 10 words
I WOULD LIKE TO WIN THE MEGA CD BECAUSE

APPLICANTS CAN ENTER AS MANY TIMES AS THEY WISH, AS LONG AS THE FEE OF £1 ACCOMPANIES EACH ENTRY. PHOTOCOPIES ARE ACCEPTABLE.

ENTRANT DETAILS

NAME

ADDRESS

..... POST CODE

TEL No

SIGNED

PARENT OR GUARDIAN SIGNATURE IF UNDER 18



THE SEGA MEGADRIVE

2nd

25 TO BE WON



THE SEGA MEGADRIVE AND MEGA C.D.

1st

10 TO BE WON



THE PRO ACTION REPLAY CARTRIDGE

3rd

50 TO BE WON

SEND POSTAL ORDERS TO:
(If sending cash, please make sure you send by registered post.)
UNFORTUNATELY, CHEQUES CAN ONLY BE ACCEPTED IF TOTAL EXCEEDS £2, IE 2 ENTRIES.
**PYRAMID LEISURE, ARCHWAY HOUSE,
STATION ROAD, CHESTER CH1 3DW**

RULES & CONDITIONS
The competition is open to anyone 18 years and over (anyone under 18 must seek permission from their parents/guardian) except employees, agents and families of organisers and judges. Proof of posting will not be accepted as proof of delivery. The organisers will not be responsible for postal delays or postal losses. The winner will be the entrant, in the opinion of the judges, with the most apt, original and skilful answer to the tiebreaker. Second and Third prizes will be awarded accordingly and will be judged in the same manner. The judges' decision is final. No correspondence will be entered into. Funds are not available for any other use. If the total valid entries are less than 15,000 then the first 10 prizes will be substituted with a sum equal to 4% of the monies received, Second 25 prizes substituted with 1% and Third 50 prizes substituted with 0.2%. Monies received will be held in a deposit account, withdrawals will require the signature of a solicitor.
THE CLOSING DATE OF THE COMPETITION IS 12.11.93. COMPETITION WINNERS WILL BE NOTIFIED WITHIN 28 DAYS AFTER THE CLOSING DATE.

Canon BJ-230



Way back in Issue 48, Canon scored two hits with the Canon BJ-200 and BJ-10SX printers. Can they possibly repeat that performance with the new BJ-230?

Richard Baguley squirts ink around the office to find out...

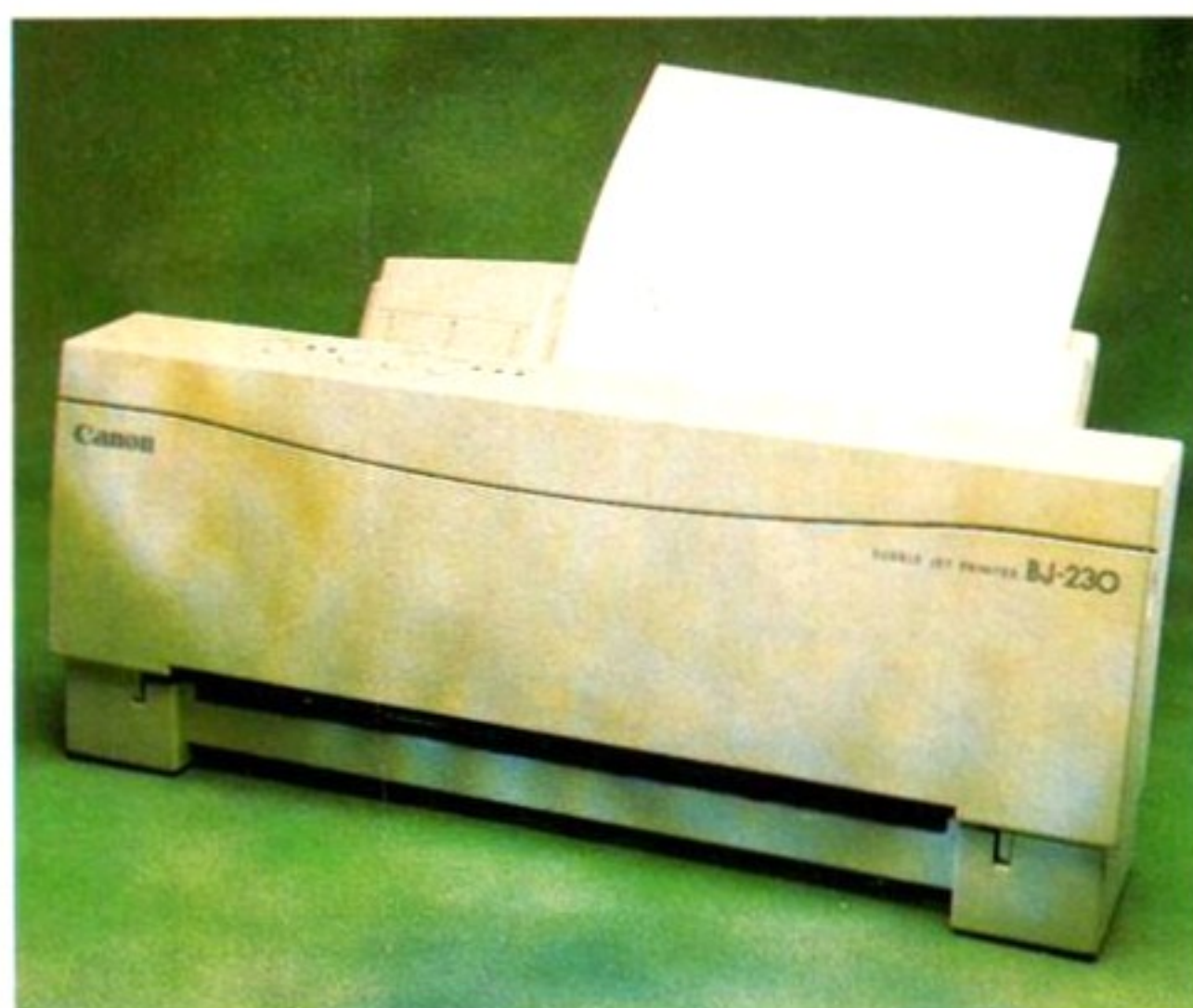

The BJ-230 is the latest addition to Canon's bubblejet stable of pedigree printers. And what a valuable addition it could prove to be, eh readers?

IF YOU'VE BEEN living under a rock for the last few years, you probably will never have heard of inkjet printing, and the words Canon BJ-10 will probably mean very little to you. However, if you have been reading the pages of *Amiga Format* in your bijou under-rock residence, you will no doubt be aware that Canon have recently released a slew of new inkjet printers, such as the BJ-10SX and the BJ-200. The latest to join Canon's happy family is the BJ-230, a wide carriage version of the *Amiga Format* Gold-winning BJ-200.

Inkjet printers operate in a radically different way to the conventional dot matrix printers which work by striking the paper through an inky ribbon, leaving some ink behind on the page. Inkjet printers work by heating a small amount of ink in a very thin nozzle. This ink then squirts out on to the paper, producing the dots on the paper. This has the benefit of being extremely quiet, although it can be rather slow. The concept of inkjet printing was allegedly discovered when a Canon research engineer is said to have touched a syringe filled with ink with a soldering iron, and the ink squirted across the room.

The BJ-230 is fundamentally much the same printer as the BJ-200, but it's been extended to enable it to cope with landscape A4 paper. This won't be important for most people, but if you work heavily with spreadsheets, it could be a bonus.

Most software (such as *ProPage* and *Pagestream*) enables you to 'turn' the page in memory, printing landscape pages on a printer that can only handle portrait. However, some programs can't handle this. So, if you want to print more rows of figures than you can fit on the width of an A4 page, this printer could be useful.

Eighty sheets of paper can be held in the sheet feeder, which automatically loads the paper as required. Canon claim a print speed of three pages per minute, but you would only approach this figure if you were working in high speed mode on a page containing only text. Add any graphics or Compugraphic fonts to the document, and things get significantly slower. For instance, the image shown on this page (done through the *AdPro PrintPrefs* saver) took around three minutes to print.

The BJ-230 has three print modes - High speed, high quality or super high quality. As you'd expect, the latter gives you the best image quality, but there is a price to pay in that your ink cartridges get used up extremely quickly. Phoenix supply a driver for this printer, and it also works fine with the BJ-10SX driver included with *Workbench 3*.

The print quality is as excellent as the other Canon models, with the same solid blacks and excellent range of tones. Add a print optimiser program (such as *TurboPrint* on last month's *Coverdisk*), and images are even better. The BJ-230 costs £60 more than the BJ-200, so unless you really need the extra width, go for the cheaper model.

This stunning print-out was produced on the Canon BJ-230 from a HAM-8 original using the PrefPrinter saver of Art Department Professional 2.3.



CANON BJ-230



DESCRIPTION

Bubblejet printer

MANUFACTURER

Canon

DISTRIBUTOR

Phoenix 0532 350091

PRICE

£379.99

RELEASE

Out now

SPEED

Not the fastest printer on earth, but it's pretty fast with text. ●●●

MANUAL

A 112 page manual gives you all the technical info you'll need. ●●●●

ACCESSIBILITY

With built-in Epson emulation, it's just a question of plug in and go. ●●●●

FEATURES

360 by 360 DPI resolution, and excellent greyscale rendition. ●●●●

VALUE

How many people will want to pay extra for the wide carriage? ●●●

VERDICT

“ Although it's more expensive than the BJ-200, the BJ-230 has the advantage of a wide carriage facility, which could be very useful for people who need print-outs of spreadsheets. ”

90%

DIRECT

4D Driving.....£5.99	Dune.....£14.99	Nigel Mansell's Grand Prix.....£14.99
Amos Professional.....£39.99	Epic.....£14.99	Player Manager.....£5.99
Body Blows.....£16.99	Federation of Free Traders.....£5.99	Premier Manager.....£15.99
Bombozal.....£5.99	Football Crazy.....£12.99	Robocop 3.....£14.99
Civilisation.....£19.99	Jaguar XJ220.....£9.99	Sim City/Populous.....£14.99
Continental Circus.....£5.99	Jimmy White Snooker.....£14.99	Spritz Paint.....£5.99
Curse of Enchantia.....£12.99	Kick Off 2.....£5.99	Super Fighters.....£14.99
Darkmere.....£14.99	Lemmings 2 + Free T-Shirt.....£17.99	Thunderhawk.....£9.99
Doodle Bug.....£10.99	Lion Heart.....£17.99	WWF2 - Euro Rampage.....£14.99
Dream Team.....£14.99	Lure of the Temptress.....£14.99	

BLANK DISKS

100% CERTIFIED FULLY GUARANTEED

20£8 100£30

50£17 250£70

(PLEASE ADD £3.00 P&P ON ALL BLANK DISK ORDERS)

EDUCATIONAL

SHAPES AND COLOURS.....	£5.99
FIRST LETTERS.....	£5.99
TELLING THE TIME.....	£5.99
THINGS TO DO WITH NUMBERS.....	£5.99
SPELLBOOK.....	£5.99

FOOTBALL CRAZY

KICK OFF 2/PLAYER MANAGER/FINAL WHISTLE

ONLY £9.99

AUNT ARCTIC ADVENTURE.....	£5.99	FIGHTER JOYSTICK.....	£5.99
PAPERBOY 2.....	£6.99	(FULLY MICROSWITCHED, 2 FIRE BUTTONS)	
CONTINENTAL CIRCUS.....	£5.99	JOHN BARNES FOOTBALL.....	£9.99
FLIGHT OF THE INTRUDER.....	£9.99	MOUSE MATS.....	£2.00

LANGUAGE LEARNING PACK

SPANISH TUTOR..... RRP £19.99

FRENCH MISTRESS.....RRP £19.99

GERMAN MASTER.....RRP £19.99

ITALIAN TUTOR..... RRP £19.99

ALL 4 FOR ONLY £19.99

LEMMINGS 2 + FREE T-SHIRT

ONLY £17.99

BUY ANY THREE £5.99 GAMES FOR ONLY £15.00 !!

ZYDEC EXTERNAL DRIVE £49.99

10 GREAT GAMES £9.99

HEIMDALL ONLY £9.99

2001 Amiga.....11.99	Dune.....19.99	James Pond.....7.49	PGA Tour Golf + Courses.....19.49	Speedball 2.....£15.99
A300 Air Bus.....21.99	Dune 2 Amiga.....17.99	James Pond 2 - Robocod.....18.99	PGA Tour Golf Course Disk.....11.49	Spelling Fair (7-13yrs).....£18.99
ADI English (11-12).....18.99	Dungeon Master & Chaos Strikes Back (1 Meg).....19.49	Jimmy White Snooker.....14.99	Pinball Dreams (1 Meg).....16.49	Spirit of Excalibur (1Meg) (NOP).....£9.99
ADI English (12-13).....16.99	Dyna Blasters.....19.99	John Barnes European Football.....16.99	Pitfighter.....9.99	Starush.....£18.99
ADI Maths (11-12).....15.99	Elvira 2 - Jaws of Cerberus(1 Meg).....22.99	John Madders (UB) Football.....16.99	Pools of Darkness.....21.99	Strategy Masters (Populous, Hunter, Spirit of Excalibur, Chessplayer 2100, Deuterus).....£19.99
ADI Maths (12-13).....16.99	Espana - The Games 92 (1 Meg).....19.49	Kick Off 2 (1Meg).....8.99	Populous & Sim City.....16.99	Streetfighter 2.....£18.49
Agony.....10.99	Exile.....18.49	Kick Off 2 (Final Whistle).....9.99	Populous 2 (1 Meg).....18.49	Striker.....£18.99
Air Bucks.....17.99	Eye of the Beholder (SS)(1 Meg).....19.99	Kick Off 2 Giants of Europe.....7.99	Populous 2 + Data Disk.....21.99	Super Hero.....£19.49
Air Support.....16.99	Eye of the Beholder 2 (1 Meg).....23.99	Kick Off 2 Return to Europe.....7.99	Populous 2 Challenge Data Disk.....11.99	Super Space Invaders.....£18.99
Allen Breed (Special Edition) (1 Meg).....8.99	F19 Stealth Fighter.....14.99	Kick Off 2 Winning Tactics.....7.99	Power Up (Chase H.Q., Turican, X-Out, Altered Beast, Rainbow Islands) (NOP).....9.99	Supremacy.....£18.99
Amos Easy (First Steps to Programming).....22.99	Fables & Fiends-Legend of Kyrandia.....19.99	Kind Words 3 Word Processor.....29.99	Premiere.....15.49	Sword of Soden.....£6.99
Amos Professional (The Ultimate Amiga Programming Tool).....44.99	Falcon Classic Collection.....£9.99	Knightsmare.....19.99	Powermonger.....19.49	Syndicate Amiga.....17.99
APDVA.....16.99	Fantastic Worlds (Realms, Pirates, Mega Lo Mania, Populous, Wonderland).....22.99	Knights of the Sky (1 Meg).....32.99	Powermonger World War 1 Data Disk.....11.49	T.N.T. (APB, Hard Drive, Toobin, Dragon Spirit, Xybots) (NOP).....£7.99
Aquatic Games.....19.49	Final Fight.....16.99	Leander.....10.99	Premier Manager Amiga.....11.99	Team Yankee.....£17.99
Archer MacClean's Pool.....17.99	Fire & Ice.....16.99	Lemmings.....12.49	Prince of Persia (1 Meg).....9.99	Terminator 2.....£18.99
Amalyte.....3.99	Flame of Freedom (Midwinter 2).....17.99	Lemmings Data Disk - Oh No!.....9.99	Pro Tennis Tour 2.....£10.99	The Enforcer (Light Phaser Game).....£9.99
Armour Geddon 2.....19.49	Flashback Amiga.....17.99	Lethal Weapon.....18.99	Project X (1 Meg).....£18.99	The Lost Treasures of Infocom 1 (20 classic infocom titles).....£27.99
Ashes of the Empire.....23.99	Floor 13.....19.49	Lombard RAC Rally.....8.49	Push-Over.....£16.99	The Manager (NOP).....£19.99
Assassin (1 Meg).....17.49	Formula 1 Grand Prix.....23.99	Lotus 3 - the Final Challenge.....17.49	Puzzle Book 1.....£5.99	Thunderhawk.....£9.99
B17 Flying Fortress.....22.99	Fun School 2 (2-6).....7.99	Lotus Turbo Challenge 2.....11.99	Puzzle Book 2.....£5.99	Titus the Fox.....£9.49
Battle Isle (NOP).....19.99	Fun School 2 (6-8).....7.99	Lure of the Temptress.....19.99	Railroad Tycoon (1 Meg).....£19.99	Utopia.....£11.99
Beach Volley.....8.49	Fun School 2 (8+).....7.99	Manchester United Europe.....9.99	Rampart.....£15.99	Utopia New Worlds Data Disk.....£11.49
Bill's Tomato Game.....15.99	Fun School 3 (2-5).....16.99	Mega Sports (Summer Games 1 & 2, Winter Games).....16.99	Raving Mad Compilation.....£7.99	Vikings - Field of Conquest.....£16.99
Black Crypt.....10.99	Fun School 3 (5-7).....14.99	Micro English (6 years to GCSE, Conforms to National Curriculum).....19.99	Reach for the Skies.....£19.99	Vroom.....£15.99
Blues Brothers.....8.99	Fun School 3 (7+).....16.99	National Curriculum.....19.99	Red Baron (1 Meg).....£22.99	Vroom Data Disk.....£12.49
Business Pack for Amiga - Wordworth Word Processing, K-spread 2, Spreadsheet and K-Data Database.....64.99	Fun School 4 (2-5).....16.99	Micro French (Beginners to GCSE Conforms to National Curriculum).....15.99	Rise of the Dragon (1 Meg).....£25.99	Walker.....£19.49
Captive.....8.99	Fun School 4 (5-7).....16.99	Micro German (Beginner to GCSE and Business, Conforms to National Curriculum).....18.99	Risky Woods.....£18.99	Wheels of Fire (Hard Drive, Powerdrift, Chase H.Q. Turbo, Outrun) (NOP).....£7.99
Castles (1 Meg).....19.49	Fun School 4 (7+).....18.99	Micro Maths (11 Yrs to GCSE Conforms to National Curriculum).....15.99	Road Rash.....£19.49	Wing Commander.....£18.99
Caesar.....19.49	Gauntlet 2.....7.99	Microprose 3D Golf.....19.99	Robocop 3.....£14.99	Wiz-Kid.....£11.99
Celtic Legends.....19.99	Goal.....16.99	Midwinter.....15.99	Rome.....£19.49	Wolfchild.....£14.99
Championship Manager.....12.99	Graham Gooch Amiga.....17.99	Mini Office (Word Processor, Spreadsheet, Database, and Disk Utilities programs).....38.99	Roake's Drift.....£15.99	WWF Wrestling.....£14.99
Chaos Engine.....19.99	Graham Taylor's Soccer Manager.....18.99	Monster Pack 2 (Killing Game Show, Awesome, Beast 2).....13.99	Sabre Team.....£15.99	WWF Wrestling 2.....£15.99
Chart Attack (Lotus, Esprit, Ghoul's 'N' Ghosts, James Bond, Venus the fly trap).....19.49	Gunship 2000.....21.99	Motorhead.....11.99	Secret of Monkey Island (1Meg).....£18.99	Zool (1Meg).....£15.99
Chuck Rock.....8.99	Gunship 2000 Amiga.....17.99	Nigel Mansell's World Championship.....19.49	Secret of Monkey Island 2.....£23.99	Zool Amiga.....£11.99
Civilization.....22.99	Guy Spy.....19.49	Office (Word Processor, Spell Checker, Spreadsheet & Statistics, Database, Graphics and Basic GTP).....44.99	Secret of the Silver Blade (1Meg).....£19.99	
Cool World.....14.99	Harlequin.....12.99	Operation Wolf.....8.49	Sensible Soccer.....£10.99	
Crazy Card 3.....16.99	Heart of China (1 Meg).....22.99	Page Setter 2.0 DTP.....34.99	Shadow of the Beast 3.....£19.49	
Creepers.....19.49	Heroquest + Data Disk.....19.49	Paint 'N' Create (Educational Art Package for Kids over 6 years).....18.99	Shadowlands.....£19.49	
Curse of Enchantia.....17.99	Home Alone.....16.99	Pang.....8.49	Shadowworlds.....£15.99	
Curse of the Azure Bond (1 Meg).....17.99	Hook.....15.99	Parabol Stars.....15.99	Shuttle.....£19.99	
Cyber Assault (Light Phaser Game).....9.99	Humans.....17.99		Silent Service 2 (1Meg).....£22.99	
C-ylon.....18.49	Indiana Jones 2 Adventure (Fate of Atlantis).....23.99		Sim Ant.....£22.99	
D-Generation.....10.99	Indiana Jones Adventure.....9.99		Sim City & Populous.....£15.99	
Dark Queen of Krynin (1 Meg).....21.99	Indy Heat.....16.99		Sim City Ancient Cities.....£8.99	
Darkmere (1 Meg).....15.49	International Rugby Challenge.....17.49		Sim City Future Worlds.....£8.99	
Death Knights of Krynin (1 Meg).....19.99	International Sports Challenge.....10.49		Sim City Terrain Editor.....£8.99	
Desert Strike Amiga.....22.00	Ishar - Legend of the Fortress.....15.99		Sitco Heat.....£5.99	
Doodlebug.....13.99	Jack Nicklaus Golf.....6.99		Space Crusade.....£12.99	
	Jaguar XJ520 (1Meg).....14.99		Special Forces.....£22.99	

NAME.....ADDRESS.....

.....POSTCODE.....TELEPHONE.....

ITEM.....

ITEM.....

ITEM.....

ITEM.....

CREDIT CARD NO:.....

CARD EXPIRY NUMBER:.....

SIGNATURE.....

DIRECT SOFTWARE LTD, (Dept Amf11/sc) UNIT 3, CROSS KEYS SHOPPING MALL, ST NEOTS, CAMBRIDGESHIRE PE19 2AU

ALL PRICES INC VAT

TOTAL.....£.....

DIRECT SOFTWARE LTD, Amf11/sc UNIT 3, CROSS KEYS SHOPPING MALL, ST NEOTS, CAMBRIDGESHIRE PE19 2AU

TEL: 0908 379550 (Shop prices may vary) E & OE

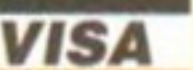

GET THEM FOR YOU



AT THE
The second
Future
Entertainment
Show

11 - 14 NOVEMBER ● LONDON OLYMPIA

THE MOST FOR AMIGA

GAMES

- See, play and buy all the latest and greatest Amiga games.

HARDWARE

- Check out all the best hardware for your machine PLUS! CD³².

SOFTWARE

- Discover what the future holds for the Amiga.

BARGAINS

- Pick yourself a great deal from the host of Amiga dealers.

ADVICE

- Meet the *Amiga Format* team, and ask them your questions.

World of Commodore Amiga at the FES Booking Form

Please state your preferred dates to attend the FES with a 1 and a 2. If we cannot supply tickets for your first choice we will send you tickets for your chosen alternative.

- Thursday 11th Friday 12th
 Saturday 13th Sunday 14th

Please reserve the following tickets for me:

Advance booking	Number	Total
£6.95 (single)	<input type="checkbox"/>	£_____
£24.95 (family)	<input type="checkbox"/>	£_____

Method of payment (please tick one):
 VISA ACCESS CHEQUE P/O

Credit card number

Expiry date:

Please make cheques payable to:
Future Entertainment Show

Please tick here if you do not wish to receive direct mail from other companies:

Name _____
 Address _____

 Signature _____

Now send this form to:
**Future Entertainment Show, PO Box 2,
 Ellesmere Port, South Wirral, L65 3EA**

SOFTWARE

Some of the following games titles are limited offers at the time of going to press. Order early to avoid disappointment. We stock all the latest titles which we offer at **30% OFF** R.R.P.

EDUCATIONAL

ADIEnglish(11/12or12/13)	16.99
ADIEnglish(13/14or14/15)	16.99
ADIFrench(11/12or12/13)	16.99
ADIFrench(13/14or14/15)	16.99
ADIMaths(11/12or12/13)	16.99
ADIMaths(13/14or14/15)	16.99
ADIJunior Counting(4/5)	13.99
ADIJunior Counting(6/7)	13.99
ADIJunior Reading(4/5)	13.99
ADIJunior Reading(6/7)	13.99
Answerback Junior	13.99
Answerback Senior	13.99
Arithmetic (Answrbak data)	7.49
Spelling (Answrbak data)	7.49
Better Maths (12-16)	13.49
Better Spelling (over 8)	13.49
Cave Maze	10.99
Count and Add	16.99
First Letters	6.99
Fraction Goblins	10.99
FunSchool2(2-6,6-8,or8+)	6.99
FunSchool3(2-5,5-7,or7+)	16.99
FunSchool4(2-5,5-7)	16.99
FUN SCHOOL 4 (7+)Only	9.99
Henriettas Book of Spells	16.99
Hooray for Henrietta	16.99
Kid Pix (Paint Package)	16.99
KidsAcademyWWW4-8	13.99
KidsAcademyShop'n 6-8	13.99
KidsAcademyPuzzle 6-8	13.99
Lets Spell at Home	13.99
Lets Spell at the Shops	13.99
Lets Spell Out and About	13.99

TRIPLE ACTION

**Titus the Fox
Ghostbusters 2
Targhan**
£9.99

Magic Maths (4-8)	13.49
Maths Adventure	16.99
Maths Dragons	10.99
Maths Mania (over 8)	13.49
Mavis Beacon Typing 2	19.99
Mega Maths	16.99
Merlin Maths	16.99
Micro English	16.99
Micro French	16.99
Micro German	16.99
Micro Maths	16.99
Micro Science	16.99
Mickey Mouse ABC	16.99
Mickey Mouse Jigsaw	16.99
Mickey Mouse Memory	16.99
Mickey Mouse 123	16.99
Mix & Match	16.99
Noddy's Playtime	16.99
Paint and Create	16.99
Paint Me a Story	14.99
Picture Fractions	10.99
Reasoning With Trolls	10.99
Shapes and Colours	6.99
Shoe People	7.99
Sooty's fun with numbers	13.99
Spelling Fair	16.99
Telling The Time	10.99
Things to do Numbers	13.99
Things to do Words	13.99
Thomas Tank fun words	13.99
Three Bears	13.49
Tidy The House	10.99
Time Files	10.99

CHAMPIONS
Manchester United,
World Champ. Boxing
Manager,
J.Khan Squash.

Only £9.99
OK A500+ and A600

POST HASTE

11a, Burgate Lane, Canterbury, Kent. CT1 2HH
TRY US.. WE LIVE UP TO OUR NAME.. RING NOW!!!
TEL.0227-764204 9.30am to 7.00pm
(Answerphone outside normal hours)

Select any 3 titles £7.99 or less for only £20.00

GAMES

888 Attack Sub	9.99
Action Stations	7.99
Addams Family	7.99
Agony	7.99
Alien Breed 92	7.99
Armalyte	6.99
Ashes of the Empire	12.99
Bard's Tale III	7.99
Batman the Movie	6.99
Battlechess	7.99
Battle Squadron	6.99
Bignose Caveman	6.99
Bills Tomato Game	9.99
Blitzkrieg	7.99
Bloodwych	6.99
Boston Bomb Club	7.99
Bubble Bobble	6.99
Bubble Dizzy	6.99
Budokhan	9.99
Bully Sporting Darts	6.99
Carrier Command	7.99
Centurion Def. of Rome	7.99
Chart Attack (James Pond)	9.99
Chase HQ 2	7.99
Chuck Rock	9.99
Classic 4 (ok kick 1.3)	6.99
Colossus Chess X	6.99
Count Duckula 2	6.99
Deluxe Strip Poker 2	9.99
Dizzy Prince of Yolkfolk	6.99
Edd the Duck 2	6.99
F15 Strike Eagle 2	11.99
F16 Combat Pilot	7.99
F17 Challenge	8.99
F19 Stealth Fighter	10.99
Falcon	9.99
Fantasy World Dizzy	6.99
Face Off Hockey	7.99
Final Fight	7.99
Flight of the Intruder	9.99
Flimbos Quest	7.99
Future Wars	9.99
Gem X	6.99
Ghouls 'n' Ghosts	6.99
Grand Prix Circuit	7.99
Gunboat	8.99
Hardball	7.99
Hero Quest	7.99
Humans-Jurassic Levels	9.99
Indy Jones+L.C.Gr.Adv	9.99
International Karate +	6.99
Jack Nicklaus Golf	6.99
Jaguar XJ220	8.99
James Pond	6.99
John Barnes Football	7.99
K.G.B.	9.99
Keef The Thief	7.99
Kick Off 2	7.99
KickOff 2 Europe data	6.99
KickOff 2 Giants data	6.99
KickOff 2 W.Tactics data	6.99
Killing Game Show	7.99
Last Ninja 3	7.99
Leander	9.99
Little Puff	6.99
Lombard RAC Rally	6.99
Loom	9.99
Lords of time	6.99
Lotus 2	7.99
Lotus 3	9.99
M1 Tank Platoon	9.99
MacDonaldland	9.99
Magic Garden	7.99
Magicaland Dizzy	6.99
Man. United Europe	7.99

Maniac Mansion	9.99
Mega Twins	7.99
Mercs	7.99
Microprose Soccer	6.99
Midwinter	9.99
Midwinter 2	11.99
Myth	7.99
Narco Police	6.99
Navy Seals	7.99
New Zealand Story	6.99
North & South	6.99
Oh No More Lemmings	9.99
Operation Harrier	7.99
Operation Stealth	9.99
Operation Thunderbolt	6.99
Ork	9.99
Outrun Europa	7.99
Pacland	7.99
Pacmania	7.99
Pang	6.99
Paperboy 2	7.99
Pictionary	6.99

Shadow Dancer	7.99
Shadow of the Beast 3	9.99
Shadow Warriors	6.99
Shadowlands	7.99
Silent Service 2	12.99
Simpsons	7.99
Slightly Magic	6.99
Smash TV	6.99
Sooty & Sweep	6.99
Space Crusade (Data)	9.99
Spellbound Dizzy	6.99
Steg the Slug	6.99
Streetfighter	7.99
Strikfleet	9.99
Stunt Car Racer	6.99
Supercars 2	7.99
Super Monaco GP	7.99
Switchblade 2	7.99
Swiv	7.99
Team Yankee	7.99
Tennis Cup 2	7.99
Terminator 2	6.99

SERIOUS

VIDEO & MULTIMEDIA

Photon Video (Cel Anim.)	7.99
Adorage	54.99
Big Altern. Scroller 2	54.99
Broadcast Titler 2	174.99
Hyperbook	49.99
Scala	174.99
Scala 500	74.99
TV Text Professional	74.99
TV Show 2	49.99
Videotitler 1.5 3D	69.99
Video Director	94.99
Video Fonts (Gold Disk)	39.99

WORDPROCESSING

Final Copy II V2	74.99
SoftFaces 1,2,3 or 4(Fonts)	54.99
SoftClips	37.99
Penpal	34.99
Excellence 3	54.99
Protex 4.3	39.99
Protex 5.5	99.99
Transwrite	9.99
Wordworth 2	79.99
Typesmith	109.99

SPREADSHEET

ProCalc	124.99
Advantage	39.99
DG Calc	28.99
Maxiplan 4	39.99

DATABASES

Infofile (Fast Ram Only)	19.99
Superbase Personal 2	19.99
Superbase 4	99.99
SuperbasePro4 v1.3	199.99

INTEGRATED (WP/SS/DB)

InterOffice	37.99
Mini Office	37.99
Gold Disk Office	49.99

DESKTOP PUBLISHING

Pagesetter 3	49.99
PageStream	129.99
Publisher	34.99
Pro Page 4	99.99
Pro Draw 3	89.99
Outline fonts	99.99
Gold Disk Fonts 1-4	34.99
Expert Draw	49.99

CAD

X-CAD 2000	89.99
X-CAD 3D	299.99
X-CAD Professional	89.99

ACCOUNTS

Arena Accounts	69.99
Home Accounts	22.99
Home Accounts 2	34.99
Cashbook/Final Accounts	49.99
Person Finance Manager+	27.99

GRAPHICS

Deluxe Paint IV AGA	64.99
Spectracolor	54.99
ProFills	24.99
Turboprint Professional	34.99
Art Department Pro 2.15	129.99
Morph Plus	139.99

3D MODELLING & RENDERING

4D-Professional	199.99
Expert Draw 4D Jnr	47.99
Sculpt 3DXL	84.99
Sculpt Animate 4D	199.99
Vista Professional V3	44.99
Imagine 2	149.99
Real 3D Pro/Turbo V2	319.99
Real 3D Classic	67.99
Scenery Animator V4	54.99

PROGRAMMING

Easy AMOS	22.99
AMOS Compiler	19.99
AMOS 3D	22.99
AMOS Professional	32.99
AMOS Pro Compiler	22.99
Devpac 3	49.99
Hisoft Pascal	74.99
GFA Basic 3.5	7.99

MUSIC

Bars & Pipes Pro 2	199.99
--------------------	--------

TOP TITLES SPECIALS

Putty, J Madden's F'ball, Sensi Soccer 92/93, A.Macleans Pool, Prem Manager, N. Mansell Grand Prix, Chaos Engine, Worlds of Legend, Battle Isle 93,Robocod(1200),Open Golf(1200),Woodys World, Curse of Enchantia... **£16.99 EACH**

BodyBlows, Superfrog, Scrabble, Streetfighter 2 **£17.99 EACH**

Alien 3(ring), Populous II, Ishar2, Castles, Pinball Fantasies, Reach For The Skies, War in the Gulf, Combat Air Patrol, Flashback, Humans 2, Eye of the Beholder 2, Lionheart, G. Gooches Cricket, Desert Strike, GOAL!, Walker, SpaceLegend(W.Comm/Elite/Megatravel) Dune2, Caesar Deluxe, Air Bucks 1.2, Sports Masters, Soccer Kid, 1869, Whales Voyage, Nippon Safe... **£19.99 EACH**

Civilisation, Mprose Grand Prix, Campaign, Nick Faldo Golf, Gunship 2000, History Lines, Sim Earth, Legend of Kyrandia, A-Train, B17 Fortress, Napoleonic Syndicate, Sim Life(1200 or 500/600), F117 Nighthawk(ring), Civilisation(1200)(ring)... **£22.99 EACH**

Monkey Island 2, Indiana Jones Fate Atlantis... **£23.99 EACH**
Legends of Valour, Blade of Destiny **£25.99 EACH**

Pinball Magic	7.99	Test Drive II	6.99
Pirates	9.99	Thomas Tank & Friends	6.99
Pitfighter	6.99	Thunderbirds(ok kick 1.3)	7.99
Pools of Darkness	14.99	Thunderhawk	7.99
Popeye 2	6.99	TOKI	7.99
Populous + Lands	9.99	Total Recall	6.99
Postman Pat 3	6.99	Trivial Pursuit	6.99
PP Hammer	6.99	Turbo Outrun	6.99
Prehistorik	7.99	Turrican	6.99
Premier	9.99	Turrican II	7.99
Prince of Persia	6.99	Ultimate Golf	7.99
Pro Tennis Tour	6.99	Utopia + New Worlds	9.99
Project X	8.99	Video Kid	7.99
R-Type	6.99	Voodoo Nightmare	6.99
Railroad Tycoon	12.99	White Death	7.99
Rainbow Islands	6.99	Winning 5 Compilation	7.99
RFI Baseball 2	6.99	World Leaderboard Golf	7.99
Rick Dangerous 2	7.99	WWF Wrestlingmania	7.99
Robin Hood (Codemasters)	6.99	X-Out	6.99
Robocop	6.99	Z-Out	6.99
Rodland	7.99	Zak McKraken	9.99
Secret of Silver Blade	14.99	ZOOL	9.99

All Prices Include Delivery To Your Door.

NOVEMBER ORDER FORM

Name _____
Address _____
Tel.No. _____
Cheque/Credit No. _____
Expiry Date _____ Description of _____
Customer Ref.No. _____ Machine _____
Titles _____

You name it!...We do it!...
Just phone and we'll quote!
WE STOCK ATARI ST S/W
WE STOCK IBM/PC S/W
WE STOCK SNES CARTS.
WE STOCK SEGA CARTS.
WE STOCK LYNX CARTS.
WE STOCK C64 CARTS.

MAIL & TELEPHONE
ORDERS ONLY!.....

NO PERSONAL CALLERS!

ADVANCE BOOKINGS

We accept advance orders for new releases. You can order with peace of mind as we will despatch on day of release. Your account will not be debited until date of release.

Superjam V1.1	79.99
TigerCub	74.99
Music Mouse	9.99
Quartet	19.99
Stereo Master	29.99
Deluxe Music Const. Set	49.99
AudioEngine. Sampler V2	199.99
TechnoSound Sampler	29.99
Technosound Samples V2	34.99
Midi Interface + Lead	19.99

MISCELLANEOUS

Cross Dos 5	19.99
Directory Opus 4	54.99
Ami-Back	34.99
Ami-Back Tools	34.99
GB Route Plus (New Vers.)	34.99
Quarterback 5 H/D Backup	47.99
Quarterback Tools Deluxe	89.99
Icon Paint	7.99

HARDWARE

A500 Plus Cartoon Classics	189
A600 Basic Pack	179
A600 Wild Weird & Wicked	199
A600HD 20Mb Epic Pack	269
A600HD 40Mb Epic Pack	299
A1200	269
A1500-Business (1 Only)	399
A4000/030(120MB)	ring
GVP A500 42Mb+8Mb(0k)	199
GVP A500 80Mb+8Mb(0k)	299
GVP A500 120Mb+8Mb(0k)	399
GVP SCSI Control+8Mb(0k)	119
GVP SCSI 80Mb+8Mb(0k)	299
GVP SCSI 120Mb+8Mb(0k)	399
80Mb for A600/A1200	199
120Mb Maxtor bare h/drive	359
45Mb to 520Mb Bare h/disks POA	
Cumana 3.5" External Drive	55

AMIGA A1200

Race'n'Chase
Nigel Mansell Grand Prix
Trolls and DPaint 3
£289.99

Zappo 3.5" External Drive	55
Zydec 3.5" External Drive	53
A500 3.5" Internal Drive	49
A600 512k Upgrade	19
A600 1Mb Upgrade	38
A500 Plus 1Mb upgrade	35
A500 512k Ram (no clock)	20
A500 512k Ram + clock	25
1.5 Mb Ram Expansion	79
A500RX 8Mb RAM (2Mb)	129
A500RX 8Mb RAM (4Mb)	219
A500RX 8Mb RAM (8Mb)	339
1 Mbyte Simms	POA
256kx4 RAM chips per Mb	40
1Mbx1 DRAM chips per Mb	40
AT-Once PC 286 Emulator	189
Rombo Vidi 12 Pack	89
Sharp JX100 A8 Col. Scanner	399
Zydec Hand Scanner	99
Power Scanner	99
Genitizer Graphics Tablet	129
Zydec Mouse(Microswitched)	12
Itsa Mouse (Microswitched)	12
Mouse Mat	3
50 Blank Disks	25

MONITORS

Philips 8833-II (UK Model)	189
Commodore 1084/1085s	199
Commodore 1940 Multisync	289
Commodore 1942 Multisync	389

PRINTERS

(Inc. lead+Amiga Printer Driver)	
Star LC100 Colour	169
Star LC200 Colour	199
Star LC24-200 Colour	269
Starjet (Bubblejet)	219
Starscript Postscript Laser	1099
Citizen Swift 90 Colour	179
Citizen Swift 240 Colour	299
Citizen Swift 200 Colour	229
Canon Bubblejet Portable	219
HP Deskjet 550C Colour	579
HP Deskjet500C	399
HP Deskjet510 Mono	319

AMIGA A500 PLUS
CARTOON CLASSICS
With Deluxe Paint 3,
Lemmings, Simpsons &
Captain Planet.
Mouse, modulator & Leads

£189

Origins

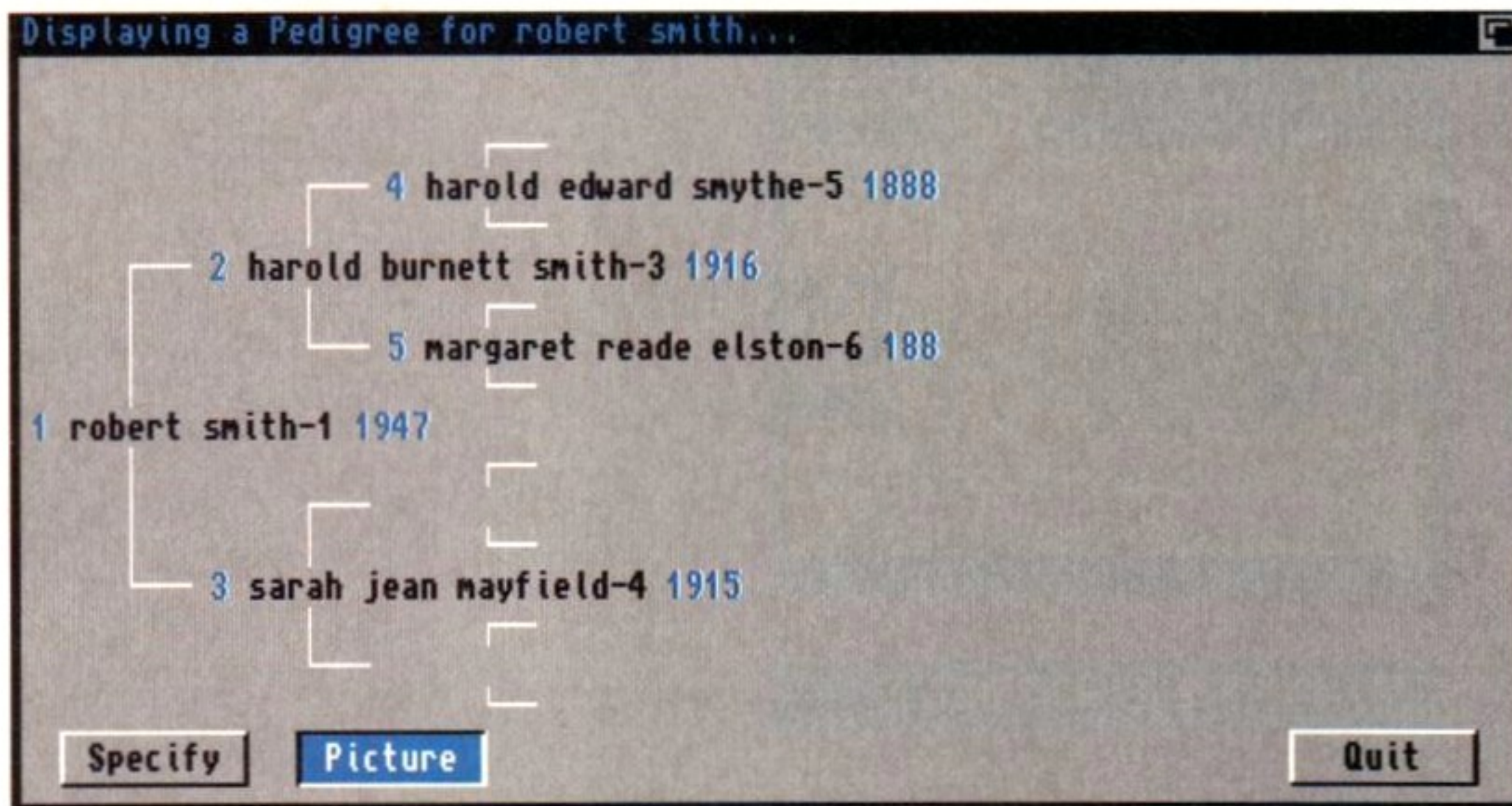

Richard Baguley decides it's time to get back to his roots, so he tries it with a new ancestor-tracing program from The Puzzle Factory.

With *Origins*, you can produce a pedigree chart for any member of the family. There is also no reason why you couldn't use *Origins* for keeping track of a family of, say, pigeons.

MANY PEOPLE ARE intrigued by the idea of being able to trace their family line. It's interesting to see how far back you can go, and what distinguished people you may be distantly related to.

Given that everybody has (more or less) two parents, once you go back several generations you're dealing with an awful lot of people. Go as far back as your fifth generation, and you have 127 people to deal with, and these are only your direct relations. Add to this any further branches of your family tree (such as uncles and cousins) and you can see how using a computer can be useful to keep track of the swelling ranks of your family.

The most widely used genealogy program on the Amiga is *A-Gene*, which is now up to version 4. There isn't much difference between *Origins* and *A-Gene* in the method of inputting data, although this is probably more to do with established standards - records being kept on cards - than any copying between the programs.

However, *Origins*' reports are more flexible and process faster, although an option to design your own reports would have been useful. *A-Gene* is written in GFA basic and so its slower speed isn't a surprise. *Origins* also supports the Tiny Tafel specification, which is designed to give a small resumé of your family tree. This can be uploaded to a Bulletin Board so that others can scan it, or add information to your database.

Both *A-Gene* and *Origins* also support the GENCOM standard, which is designed to allow you to move information between programs running on different machines. Both programs can also attach IFF images

Displaying a Family Group...

Father(s) (3)	smith, harold burnett	Birth date:	15 nov 1916
Mother(s) (4)	mayfield, sarah jean	Birth date:	03 jun 1915
Marriage date:	15 jun 1938	Location:	norfolk, va
#	G Children	Birth date	Birth city
1	M smith, robert	07 Jan 1947	Orange
2	F smith, julia	02 nov 1951	anaheim

Buttons: Previous, Next, Specify, Sources, Notes, Picture, Quit

Among the many reporting options is one to display a family group, which gives you basic details of both the parents and the children.

to records, so you could have a scanned photograph of your subject or an image from a video attached to each record.

Two ARexx interfaces are also included in *Origins*. One is designed for controlling an editor such as *Cygnus Ed* or *TurboText*, which are more powerful than the built-in editor. The other ARexx interface allows you to control *Origins* itself, and to import or export data from this. It might not sound particularly useful, but you could use it to connect the program to a Bulletin Board system, allowing you or others to read data or load data into your database from a remote location. If you're a good ARexx programmer, you could even use it to generate your own reports, or import the data into a DTP program to produce quality print-outs of the data.

Origins is faster than *A-Gene*, but it's also more expensive. If you just want the basic data storage and retrieval functions, *A-Gene* will suit you fine, but if you want to expand from this into more complicated areas such as moving data between programs, *Origins* is well worthwhile.

ORIGINS



DESCRIPTION
Genealogy database

PROGRAMMER
Jeff Lavin, The Puzzle Factory

DISTRIBUTOR
Helios Software 0623 554828

PRICE
£75

RELEASE
Out now

SPEED ●●●●
Searching through large databases is done very rapidly.

MANUAL ●●●
Fairly well written, although a bit dense in places, with plenty of tips.

ACCESSIBILITY ●●●
Complex, but it manages large amounts of data well.

FEATURES ●●●
Built-in reports good, but option to do your own would be better.

VALUE ●●●
More expensive, but more flexible than its rival *A-Gene*.

VERDICT

“ Very similar to its nearest rival *A-Gene*, but *Origins* has many more features and so quite reasonably has a higher price. This is a powerful, flexible genealogy program. ”

75%



OPEN ALL HOURS

WELL, NEARLY!
9am-10pm Mon-Sat
10am-6pm Sunday

AMIGA COMPUTERS

A500 Cartoon Classics	£199.00
A600 Wild Weird & Wicked	£229.00
A600 HD Epic Pack	£299.00
A1200	£299.00
A1500/A2000	£ phone
A3000	£ phone
A4000	£ phone
Monitor	£195.00

RAM & DISK DRIVES

External Disk Drive	£55.00
A570 CD Rom + software	£149.00
A500+ 1 meg Exp	£33.95
A500 int drive	£49.00
A500 512k no clock	£18.95
A500 512k + clock	£23.50
A500 + 1meg exp	£37.00
A600 1meg + clock	£44.00
A500 1.5meg	£79.00
A500 8meg, 4 fitted	£169.00
GVP 42meg	£249.00
GVP 80meg	£299.00

PRINTERS & RIBBONS

Star LC20	£133.00
Star LC100 Colour	£169.00
Star LC200 Colour	£194.00
Seikosha 24 Pin Colour	£199.00
Star LC24-200 Colour	£274.00
LC100 mono ribbon	£4.50
LC100 colour ribbon	£6.75
LC24 200 mono ribbon	£5.50
LC24 200 colour ribbon	£13.50
LC20 mono ribbon	£4.50

LEADS & CABLES

Printer	£3.99
Serial	£3.99
Null Modem	£5.99
Joystick Extender 3 metre	£3.99
Joystick/Mouse Extender	£3.99
Amiga to SCART	£7.99
Analog Joystick Adapter	£4.99
4 Player Adapter	£5.99

LOOK! LOOK! LOOK!

TRACTORFEED DISK LABELS

Now you can print your own professional disk labels!
500 Plain white disk labels on tractor feed, complete with FOUR disks of software and artwork.

**Yours for ONLY
£9.95**

1000 Labels with software
ONLY £13.50

SPECIAL OFFERS!!

A500 MODULATORS	£24.50
A500 POWER SUPPLY	£29.95

2.5" HARD DRIVES FOR A600/A1200

40 MEG	£129
85 MEG	£189
130 MEG	£269

**ALL DRIVES SUPPLIED WITH LEADS
AND READY FORMATTED**

DISKS & LABELS

All disks are supplied with labels.
UNBRANDED DISKS are 100% error free.
In the unlikely event that any of our disks are faulty, then we will replace the disks **AND** reimburse your return postage!

3.5" DSDD	£0.37 each
3.5" Rainbow	£0.44 each
3.5" DSHD	£0.58 each

3.5" DSDD Fuji (box of 10)	£4.90
3.5" DSHD Fuji (box of 10)	£8.90
5.25" DSDD Fuji (box of 10)	£2.50
5.25" DSHD Fuji (box of 10)	£4.90

1000 3.5" labels	£6.50
1000 3.5" tractorfeed	£8.50

STORAGE BOXES

Most types are available for 3.5" or 5.25" disks.

10 capacity	£0.95
40 capacity	£3.49
50 capacity	£3.95
100 capacity	£4.50
80 capacity Banx drawer	£8.49
150 capacity Posso drawer	£15.95
200 capacity drawer	£22.50

VISIT OUR NEW SHOP

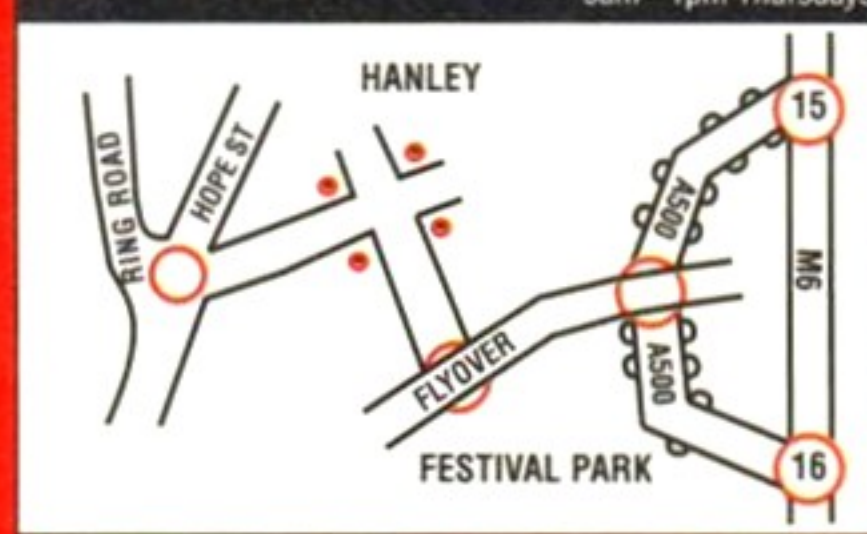

9am - 5.30pm
Mon - Sat
9am - 1pm Thursdays

MISCELLANEOUS

Mousehouse	£1.80
Mousemat 9mm thick	£2.50
Diskdrive cleaner	£1.80
A500 Dustcover	£3.50
A600 Dustcover	£3.50
A1200 Dustcover	£3.50
Monitor Dustcover	£3.50
LC20 Dustcover	£3.50
LC100 Dustcover	£3.50
LC200 Dustcover	£3.50
LC24-200 Dustcover	£3.50
Roboshift	£13.95
Amiga Lightpen	£32.00
Optical Mouse	£32.00
Megamouse	£12.95
Manhattan Mouse	£9.99
Primax Mouse	£12.95
Itsa Mouse	£12.95
Altadata Trackball	£26.95
Crystal Trackball	£32.00
Zydek Trackball	£25.95
Zyfi Amp/Speakers	£37.50
Action Replay Mk III	£56.95
Technosound	£32.00
Midi Master	£26.00
Tilt/Turn Monitor Stand	£9.95
2-piece Printer Stand	£3.49
A4 Copyholder	£5.99
ROM Sharer	£14.95
V1.3 ROM	£25.95
V2.04 ROM	£35.95
Microperf Tractorfeed Paper: 500 sheets	£4.50
2000 sheets	£13.00

JOYSTICKS

All joysticks have autofire feature except those marked *

Trigger Grip Models	
Quickshot turbo	£6.95
Python 1M	£7.99
Jetfighter	£12.00
Topstar	£19.50
Intruder	£21.50
Base Fire Button Models	
Maverick 1M	£12.95
Megastar	£21.50
Zipstick	£12.95
Comp Pro 5000*	£10.95
Comp Pro Extra	£12.95
Comp Pro Star	£12.95
Cruiser Multicolour*	£9.95
Comp Pro Star MINI	£14.95
Aviator 1 Flightyoke	£23.50
Handheld Models	
Speedking	£10.50
Navigator	£13.95
Bug	£12.00

ANALOG JOYSTICKS

These Joysticks will fit any Amiga

Warrior 5	£14.95
Saitek Megagrip 3	£19.50
Speedking Analog	£13.95
Intruder 5	£25.50
Aviator 5 Flightyoke	£27.50
Adapter to use any PC analog joystick on an Amiga	ONLY £4.99

Direct

COMPUTER SUPPLIES



0782 206808 - Anytime
0782 642497 - 9.00am-5.30pm Weekdays
0630 653193/0782 320111 - Evenings & Weekends



BUSINESS HOURS
9am to 10pm Mon-Sat, 10am to 6pm Sun

All items and offers subject to availability. E&OE
P&P £3.30 All Prices inc VAT

We accept POs, cheques & credit cards

Please write Cheque Card Number on cheque for instant clearance



BUSINESS AND EDUCATION ORDERS WELCOME

DIRECT COMPUTER SUPPLIES 36 HOPE ST, HANLEY, STOKE ON TRENT ST1 5BS

Macro68 ASSEMBLER

There's a new assembler in town, and it's very quick on the draw. Jolyon Ralph wonders whether its speed alone is sufficient to kill off the wily, adaptable old favourite, Devpac...

```

AmigaShell
S:\Programs:macro68> dir *.asm
ARexxExample.asm      CompareDates.asm
Display.asm           ExampleRexxBlock.asm
Expunge.asm          ffpConvert.asm
M68IFace.asm         macro68cstom.asm
makeAllSyms.asm      optim68brain.asm
Profile_68000.asm    Profile_68020.asm
SelfChecksum.asm
S:\Programs:macro68> macro68 display.asm
Macro68 Release 3.1.9 Copyright 1989-91, 92, 93, 94, 95
Source file "display.asm" assembled to "ram:Display"
Av. pass time = 0:00.18 Line count = 746 Lines/min = 447600
Assembly time = 0:00.20 Line count = 746 Lines/min = 223800
Task time = 0:00.22 Line count = 746 Lines/min = 186400
# macro(s) defined
# error(s) detected
# warning(s) given
Relocatable code
Object size = 4104 (51850) bytes
Output file size = 5164 bytes
Symbol space used = 34816 (58800) bytes
DONE
S:\Programs:macro68>

```

The assembler in action. Although aesthetics aren't important when assembling, we thought you'd like to see how fast it is...

HERE'S A BRAND spanking new 680x0 assembler, supporting all the family: the 68000, 68010, 68020, 68030, 68040, 68881, 68882, 68851 and also the Copper processors. It comes on three disks with a 128-page manual packed with information.

It does not pretend to be a full development package. All you get for your money is the assembler; you will have to find your own text editor (although there are several good Public Domain editors available and if you want help debugging your code a debugger/monitor program will come in handy).

Macro68 voices proud boasts – it claims to be "the ultimate Amiga assembler" and that "Macro68 is faster than all other Amiga multi-pass assemblers".

What that means in practice is that Macro68 is the second fastest assembler available on the Amiga. The fastest assembler is still ArgAsm, published by Argonaut Software (famous for the early Amiga 3D classic StarGlider, and more recently for the Super Nintendo game StarWing).

ArgAsm is unique because it is a single-pass assembler: rather than scanning the source code twice, it only needs to scan the source once, resulting in phenomenal assembly speed. Unfortunately Argonaut have long since abandoned ArgAsm and they have no update plans.

Macro68 has one feature that is considerably in its favour when compiling programs with large numbers of include files. Like Devpac 3 it can pre-assemble these for faster assembly, but unlike Devpac these can be held resident in RAM to speed up subsequent assemblies.

Macro68 has taken the brave step, unlike other Amiga assemblers, of using the new-style Motorola syntax. Introduced to set a standard approach for instruction syntax with the newer processors, this changes the form of many instructions. For example:

```

LEA 32(a0),a1      ;old syntax
becomes
LEA (32,a0),a1     ;new syntax
JSR _LVOWaitTOP(a6) ;old syntax
becomes
JSR (_LVOWaitTOP,a6) ;new syntax

```

Although it's a sensible idea, and if you're new to the language the new syntax may seem easier, if you're an experienced 68000 hacker, you'll probably hate it. More importantly, almost all example source published uses the old syntax, though existing source code can be converted to the new syntax with an included utility.

Other points in Macro68's favour include its ARexx handling, which is second to none. If you want to set up your own assembly environment, based around Cygnus Ed, for example, then Macro68 can control and be controlled far easier than either ArgAsm or Devpac can.

Unfair as it may seem, Macro68 has to be compared to Devpac for value, and in my opinion you just don't get your money's worth with Macro68. The extra features don't outweigh the bonuses that HiSoft offer by bundling not only a good editor but also a monitor with Devpac.

If you already have SAS C and you like the editor and debugger you already use, then Macro68 is worth a look. If you are starting with assembler, go for Devpac 3 instead. Seasoned Devpac/Argasm veterans, make your own mind up.

New Macro68 is certainly faster than my old Devpac, but its inability to handle my existing source without alterations is a major problem. Perhaps I'm missing something... or perhaps the authors are.

The Macro68 control panel is about the most interesting part of the software to look at, but it struggles if you change your system font.



MACRO68



DESCRIPTION
Full 68000-family assembler

MANUFACTURER
DigiSoft

DISTRIBUTOR
Helios 0623 554828

PRICE
£130

RELEASE
Available now

SPEED ●●●●●
The fastest 680x0 assembler. Only ArgAsm (68000 only) is faster.

MANUAL ●●
Superb and have been marked higher but it lacks an index.

ACCESSIBILITY ●●●
Not at all easy for beginners to get to grips with.

FEATURES ●●●●●
Every feature you could want from an assembler and more.

VALUE ●●●
Expensive. It does not compete with Devpac on price.

VERDICT

“ For experienced assembler users only, and then only if you have good reason to be unhappy with your current assembler, or feel a serious need for this one's speed. ”

74%

PC TASK

When is your Amiga not an Amiga? Our own identity-crisis victim, Nick Veitch, takes a new version of the software PC emulator to task.

you install the software in the RAM disk. It does multitask quite effectively, but you will notice the drain on your CPU speed when *PCTask* is running.

The emulation covers a variety of PC display drivers, including CGA, EGA and VGA, as well as a generic mono mode. Display preferences are chosen from the start-up screen, as are drive assigns and memory usage.

PCTask is restricted to a standard 704K emulation, and this does limit the amount of software that will run on it. Microsoft's Windows GUI is right out of the question, as are quite a lot of graphics-based programs. But the old standard word-processors and spreadsheets should work fine, as will a number of PC games.

Hard disk support is controlled through the start-up options. In addition to being able to choose a hard disk partition to work as a PC device, there is also the rather cunning option of creating a file on an AmigaDOS partition that acts as a PC device. These files are created by *PCTask* and can then be formatted from MS-DOS and used as either a logical C: or D: MS-DOS drive.

This cunningness is taken a bit further by having support for AmigaDOS to access these PC devices directly. If you have a PC disk transfer system such as *Messydos* or *CrossDos* (the latter is included with *Workbench 3*) then a device can be mounted enabling you to get at the PC files stored in the hard-disk file. This is potentially very useful for transferring information between the two different systems, particularly if you don't have an A4000 with a high-density disk drive.

PCTask isn't a replacement for a PC, but it is capable of running a minimal PC wordpro and undertaking menial file operations. Bear in mind that the price does not include a version of MS-DOS, which you need to use the program.

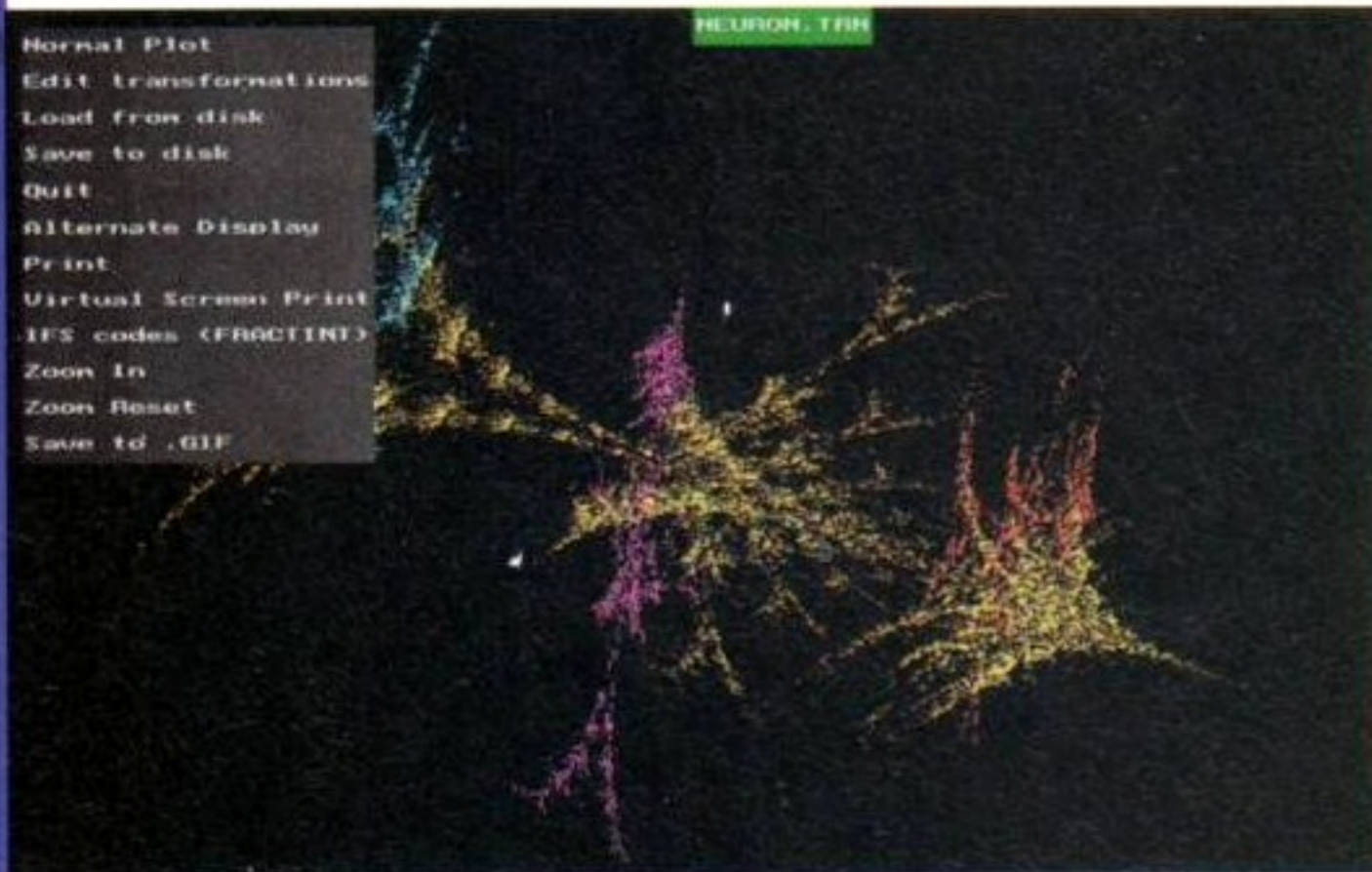

WHEN YOU HAVE a PC in the office or at school and you want to take your work home with you to your Amiga, what do you do?

Unless you are incredibly wealthy, you will not have the necessary funds or space for a PC and an Amiga – so what's to be done? Well, the favourite option for the Amiga owner about town these days seems to be some kind of PC emulator.

The emulator will convert your Amiga into a PC for the duration of its operation, enabling you to read and write PC disks and run PC software.

The trouble with most emulators is that they are hardware-based and therefore can cost almost as much as a new PC, not to mention being specific to a particular model of Amiga. *PCTask*, by contrast, is a software emulation. This means that there is no hardware to be added and no fussing with trapdoor slots and CPU jumpers; all this also makes it substantially cheaper than the competition.

There are problems with software emulators, though. They are generally slower and have a lower compatibility rate than their hardware counterparts. *PCTask* is certainly slower than a dedicated hardware emulator, but not cripplingly so.

If you can afford the memory overhead it works a great deal quicker when

Just what you need, a halfway decent PC emulator to run nice fractal programs on your Amiga-cum-PC.

The start-up screen allows you to select emulation mode, memory usage and assign or create logical PC disks.

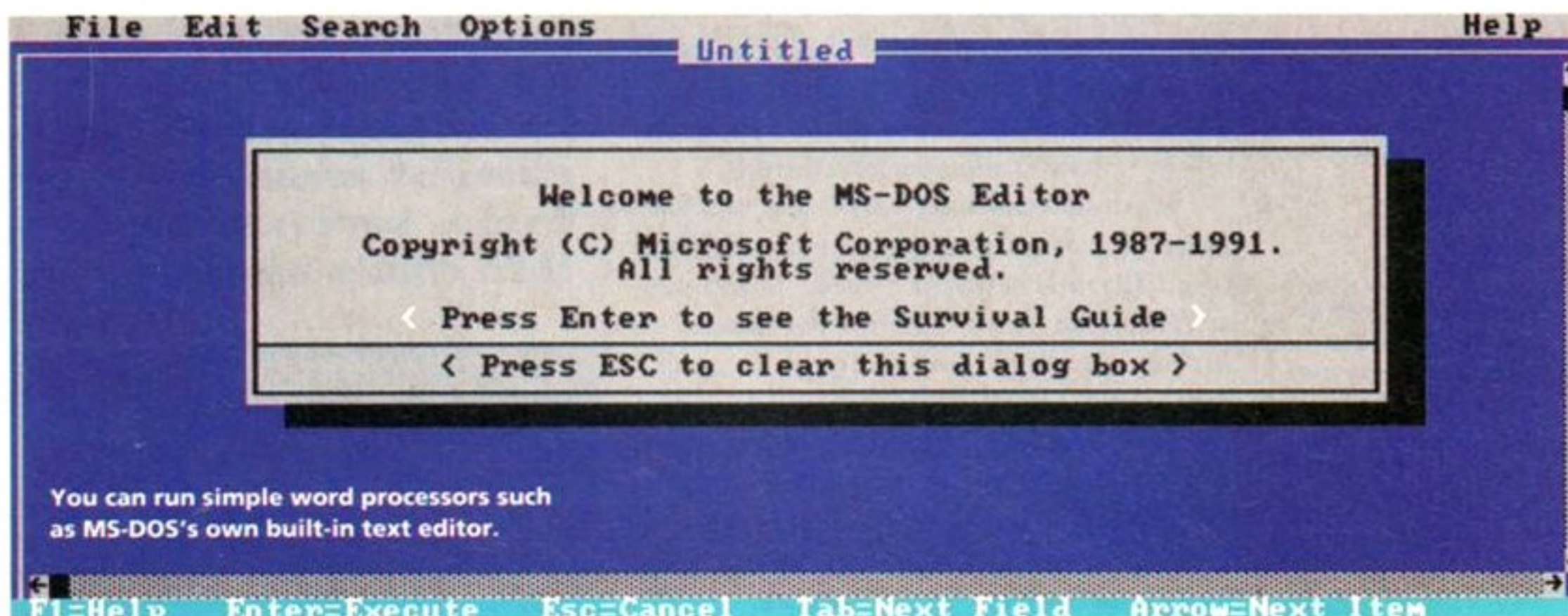
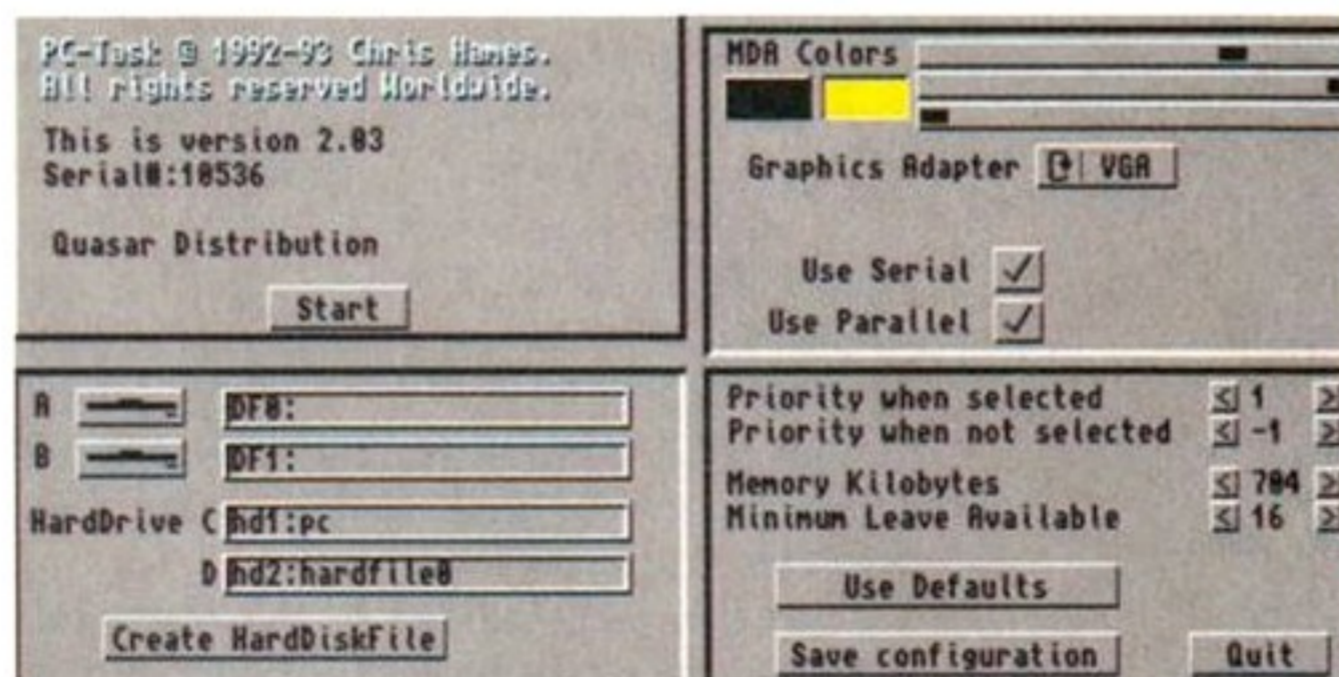

PC TASK



DESCRIPTION

PC emulator

MANUFACTURER

Quasar

DISTRIBUTOR

Meridian (081 543 3500)

PRICE

£49.95

RELEASE

Available now

SPEED

MS-DOS applications are tediously slow, which is only to be expected.

MANUAL

Brief, gives all the techinfo needed. Novices may find it confusing.

ACCESSIBILITY

Once you've got it set up, it's a real doddle to use.

FEATURES

Good emulation of CGA, EGA & VGA, held back by memory limits.

VALUE

Worth it if you desperately need to run PC-type utilities on your Amiga.

VERDICT

Reasonably cheap, especially compared to a hardware emulator, and with programs that need very little RAM, surprisingly effective, if a little slow. Could easily handle low workload tasks.

79%

ACCELERATORS FOR AMIGA 1500 AND 2000

If you use your Amiga for DTP, ray tracing, graphics or any other serious application, you'll appreciate the power that an accelerator brings. Accelerators replace the main processor with a faster version dramatically improving the Amiga's speed.



FAST! 32-bit TECHNOLOGY

GVP offer a range of A1500/A2000 accelerators that simply outstrip the competition for speed and specifications. Their G-Force range includes the fastest Amiga accelerator available (the 68040 33MHz version) whilst offering a range of functions, such as 32-bit RAM upgrades, SCSI interfaces and maths co-processors. For boosting the power of your Amiga you can't beat the GVP G-Force range!

SPECIAL OFFER SAVE £85! 42Mb QUANTUM HARD DRIVE + MOUNT KIT HAR 0943 **£149** INC VAT

G-FORCE ACCELERATORS	030 25MHz	030 40MHz	040 33MHz
Speed MIPS*	7.48	12.1	30
Processor	68030EC	68030EC	68040
Maths Co-Pro.	68882 included	68882 included	In 68040 processor
Std 32-bit RAM	1Mb	4Mb	4Mb
Max 32-bit RAM	13Mb	16Mb	64Mb
Extras	SCSI	SCSI	SCSI Ser/Par
PRICE	£349 INC VAT UPG 0110	£699 INC VAT UPG 0430	£1299 INC VAT UPG 0740

*MIPS: Millions of instructions / second, a normal Amiga runs at 87 MIPS

PLUG-IN HARD DRIVE & ACCELERATOR FOR AMIGA 500 AND AMIGA 500PLUS

The A530 is a unique combination of a hard drive, RAM board and an accelerator. Inside is a full Motorola 68030ec processor running at 40MHz making your Amiga faster than you thought possible. The A530, with a maths co-processor, is up to 300 times faster than a standard A500! The new processor and 32-bit SIMMs is joined by up to 8Mb of 32-bit RAM, which further enhances its performance. Features Include:

- 40MHz 68030EC Processor
- Up to 8Mb 32-bit Memory, 1Mb fitted
- Cut Off Switch For Game Compatibility
- Designer Styling to Match the A500
- Dedicated Power Supply and Fan Unlike Many Competitors
- Mini-slot for Future Expansions
- Factory Installed Hard Disk
- High Speed DMA SCSI Controller Can Handle 7 Devices



SAVE £300 OFF RRP

PC EMULATOR PLUGS INTO THE HD8+ OR A530 TO ALLOW YOU TO RUN PC COMPATIBLE SOFTWARE ON YOUR AMIGA **286-16MHz** EMU 0500 **£99** INC VAT

A530 HARD DRIVE & 40MHz ACCELERATOR

42Mb	80Mb	120Mb
£699 £399 INC VAT - HAR 0962	£799 £499 INC VAT - HAR 0968	£899 £599 INC VAT - HAR 0974

PLUG-IN HARD DRIVE FOR AMIGA 500 AND AMIGA 500PLUS

A hard drive will have an immediate effect on your Amiga. Where you used to constantly swap disks, wait for files and programs to load and sit around waiting for disk accesses, you'll now be pushed to keep up with your Amiga! Hard drives work in the same way as floppy disks, but can hold a great deal more information and access this data much quicker.

The A500-HD8+ provides the ultimate in hard drive performance. It can also increase the memory of your Amiga, and provide PC compatibility. Features include:

- Ultra Fast Access SCSI HD
- Up to 8Mb of FAST RAM
- Mini-slot for Future Expansions
- Cut Off Switch For Game Compatibility
- Designer Styling to Match the A500



SAVE £100 OFF RRP

- Dedicated Power Supply and Fan Unlike Many Competitors
- High Speed DMA SCSI Controller - Can Handle 7 Devices

HD8+ HARD DRIVES

42Mb	80Mb	120Mb
£299 £199 INC VAT - HAR 0840	£399 £299 INC VAT - HAR 0888	£499 £399 INC VAT - HAR 0922

GRAPHICS CARD FOR A1500/A2000/A3000/A4000



ALL-IN-ONE GRAPHICS CARD Impact Vision 24 is a fully featured video card. Unlike other graphics cards which require you to buy extra modules later, IV24 has everything you could want from a video board built-in!

Included with IV24 is GVP's custom Video Interface Unit (VIU). This gives you more choices for in and outputting video signals than any other Amiga peripheral on the market. VIU-CT splitter provides additional RGB, Y, R-Y and B-Y output.

FREE SOFTWARE WITH IV24 Create stunning 3D rendered images, retouch captured images and wipe between 2 video sources with 50 packaged video transitions for production studio effects. Also included is MacroPaint 2, a powerful 24-bit graphics package which can paint in 16.8 million colours.

- 1.5Mb 24-bit, 16.8million Colour Buffer
- Real-time Framegrabber/Digitiser
- De-interlaced, Video Flicker Fixer
- Movable/Sizable PIP (Picture-in-Picture)
- 2 Video Genlock (RGB & Composite)
- 768 x 580 Resolution
- Captured Image Retouching/Processing
- Tinting/Character Generation
- Real-time 24-bit Painting
- Animation/3D Rendering
- FREE! Calligari 24, MacroPaint 2, MyLad and Desktop Darkroom Software

A1500/A2000 ADAPTOR - £49.95 - GVA 5224	IV24 inc VIU-S	IV24 inc VIU-CT
	£1499 £999 INC VAT - VID 7024	£1899 £1299 INC VAT - VID 7124

VIDEO GENLOCK FOR ALL AMIGAS

G-Lock is a fully featured Genlock, which allows you to mix Amiga text and images with moving video pictures. You can then send the combined result back to your video recorder for recording.

- Two Composite Video Inputs or S-Video (Y/C) Input
- Simultaneous Composite & S-Video and RGB Output
- Video Processor - Real Time Software Control of Video Attributes (Sharpness, Gain, Brightness etc)
- AREXX Compatible
- Works with Flicker Fixers
- Multiple Keyer Modes
- Full Audio Support

G-LOCK **£299** INC VAT - VID 2902

HARD DRIVE CARD FOR A1500/A2000/A3000/A4000



The HC8+ hard drive card gives the ultimate in hard drive performance and can be used to increase your Amiga's RAM.

- High Speed DMA SCSI Controller - Can Handle 7 Devices
- Ultra Fast Access SCSI Hard Drive
- Up to 8Mb of FAST RAM
- Direct Memory Access Style Design

0Mb	42Mb	80Mb	120Mb
£129 £129 INC VAT - HAR 1202	£199 £199 INC VAT - HAR 1208	£299 £299 INC VAT - HAR 1214	£399 £399 INC VAT - HAR 1220

IMAGE PROCESSING FOR ALL AMIGAS WITH 4Mb RAM

Image FX is a complete solution for all your image creation and editing needs. It has a vast range of facilities, can read and write to many other different file formats and directly controls a wide variety of hardware.

- 24-bit Painting
- AREXX Compatible
- Virtual Memory Support
- Load, Save and Convert to the Following Formats: ANIM, BMP, Clipboard, DCTV, DPRE, GIF, HAM-E, LBM, IMPULSE, JPEG, RENOTION, SCULPT, TARGA, TIFF AND MORE
- Scanning, Framgrabbing & 24-bit Board Support Comes with Modules for Several Popular Hardware Devices: JX100, IV24, AGAA/AA Chipset
- Create Animations
- Numerous Special Effects Edge Feathering, Shading, Alpha Channel, Morphing, Compositing etc

IMAGE FX **£149.95** INC VAT - AIC 0202

40MHz ACCELERATOR FOR THE AMIGA 1200

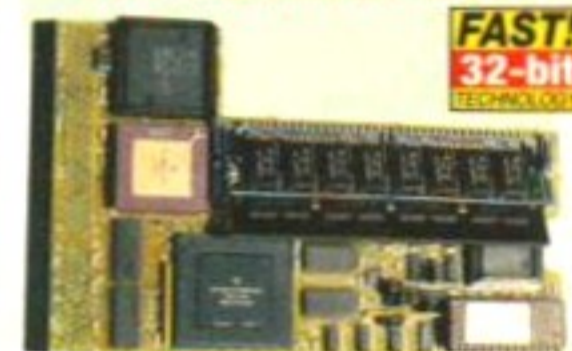

Other A1200 cards claiming to be accelerators only add maths co-processors and extra RAM, whilst the A1230 can provide both of these PLUS an enhanced CPU. This replacement CPU upgrades the A1200's existing processor with a 68030EC processor running at 40MHz!

32-bit RAM and a maths co-processor can also be added, enhancing performance still further. The A1230 doesn't void your Amiga warranty, and is also compatible with PCMCIA standard cards, not preventing their use!

- The First True A1200 Accelerator
- 68030EC Processor Running at 40MHz
- Up to 32Mb of 32-bit RAM
- Easy Fitting Trapdoor Expansion - Doesn't Void Your Warranty
- Doesn't Disable PCMCIA Interface
- Optional 68882 Co-processor - Twice the Speed of a 68881

A1230 40MHz ACCELERATOR

8Mb RAM, No FPU 40MHz CPU	4Mb RAM, No FPU 40MHz CPU	4Mb RAM, 40MHz FPU 40MHz CPU
£249 £249 INC VAT - UPG 1238	£399 £399 INC VAT - UPG 1232	£499 £499 INC VAT - UPG 1234

SOUND SAMPLER FOR ALL AMIGAS

Capture sound from an external source and play it back in stereo or mono on your Amiga. The latest version of GVP's Digital Sound Studio (DSS8+) enables you to create audio effects for use in games or jingles.

- New Style High Impact, Clear Poly-Carbonate Casing
- Simultaneously Holds up to 31 Sound Samples in Memory
- Real-time Oscilloscope, Spectrum Analysis, Echo & Reverberation
- AREXX Compatible
- Microphone Input
- .MOD File & MIDI Compatible
- FREE Samples Disk

DSS8+ **£69** INC VAT - MUS 2510

SCSI/RAM EXPANSION FOR THE AMIGA 1200

Adding RAM or a hard drive to your Amiga will have a considerable impact on its speed. The GVP SCSI/RAM allows you to enhance your Amiga with both. Its SCSI hard drive interface is one of the fastest available, whilst its 32-bit RAM upgrade is based on the same technology as that featured in the best selling A1230.

- Built-in, Full SCSI Hard Drive Interface
- Optional 8Mb of 32-bit RAM
- Optional 68882 Maths Co-processor

EXTERNAL SCSI ADAPTOR KIT - £49 INC VAT - HAR 1245

0Mb RAM	4Mb RAM - 33MHz 68882 FPU
£199 £199 INC VAT - HAR 1230	£399 £399 INC VAT - HAR 1235

VIDEO EFFECTS FOR ALL AMIGAS WITH 3Mb RAM



CineMorph from GVP opens up the world of Morphing, the process of converting one image to another to create dazzling special effects. Currently very popular in music videos and feature films, morphing has become the fashionable video effect to use. Now with CineMorph you can create these stunning effects on your Amiga.

- Supports the AA Chipset
- Static or Full Motion Morphing
- Single Image Warping
- Fast Render Times
- Renders to HAM-E and DCTV

CINEMORPH **£24.95** INC VAT - AIC 4402

ALL PRICES INCLUDE VAT - DELIVERY IS FREE OF CHARGE IN THE UK MAINLAND

SILICA SYSTEMS OFFER YOU

- **FREE OVERNIGHT DELIVERY:** On all hardware orders shipped in the UK mainland.
- **TECHNICAL SUPPORT HELPLINE:** Team of technical experts at your service.
- **PRICE MATCH:** We normally match competitors on a "Same product - Same price" basis.
- **ESTABLISHED 14 YEARS:** Proven track record in professional computer sales.
- **£12 MILLION TURNOVER (with 60 staff):** Solid, reliable and profitable.
- **BUSINESS + EDUCATION + GOVERNMENT:** Volume discounts available 081-308 0888.
- **SHOWROOMS:** Demonstration and training facilities at all our stores.
- **THE FULL STOCK RANGE:** All of your requirements from one supplier.
- **FREE CATALOGUES:** Will be mailed to you with offers + software and peripheral details.
- **PAYMENT:** Major credit cards, cash, cheque or monthly terms (APR 29.8% - written quotes on request).

Before you decide when to buy your new Amiga products, we suggest you think very carefully about WHERE you buy them. Consider what it will be like a few months after you have made your purchase, when you may require additional peripherals or software, or help and advice. And, will the company you buy from contact you with details of new products? At Silica Systems, we ensure that you will have nothing to worry about. We have been established for almost 14 years and, with our unrivalled experience and expertise, we can now claim to meet our customers' requirements with an understanding which is second to none. But don't just take our word for it. Complete and return the coupon now for our latest FREE literature and begin to experience the "Silica Systems Service".

MAIL ORDER HOTLINE **081-309 1111**



MAIL ORDER: 1-4 The Mews, Hatherley Rd, Sidcup, Kent, DA14 4DX Tel: 081-309 1111
Order Lines Open: Mon-Sat 9.00am-6.00pm No Late Night Opening Fax No: 081-308 0608

LONDON SHOP: 52 Tottenham Court Road, London, W1P 0BA Tel: 071-580 4000
Opening Hours: Mon-Sat 9.30am-6.00pm No Late Night Opening Fax No: 071-323 4737

LONDON SHOP: Selfridges (Basement Arena), Oxford Street, London, W1A 1AB Tel: 071-629 1234
Opening Hours: Mon-Sat 9.30am-7.00pm Late Night: Thursday - 8pm Extension: 3914

SIDCUP SHOP: 1-4 The Mews, Hatherley Rd, Sidcup, Kent, DA14 4DX Tel: 081-302 8811
Opening Hours: Mon-Sat 9.00am-5.30pm Late Night: Friday - 7pm Fax No: 081-309 0017

ESSEX SHOP: Keddies (2nd Floor), High Street, Southend-on-Sea, Essex, SS1 1LA Tel: 0702 468039
Opening Hours: Mon-Fri 9.30am-5.30pm (Sat 9.00am-6.00pm) Late Night: Thursday - 7pm Fax No: 0702 468039

To: Silica Systems, AMFOR-1193-68, 1-4 The Mews, Hatherley Rd, Sidcup, Kent, DA14 4DX

PLEASE SEND A 64 PAGE AMIGA COLOUR CATALOGUE

Mr/Mrs/Miss/Ms: Initials: Surname:

Company Name (if applicable):

Address:

Postcode:

Tel (Home): Tel (Work):

Which computer(s), if any, do you own?

Ameagre Prices for Amiga Users

Games

1869 (1MB)	21.95
1869 (AMIGA 1200) (1MB)	21.95
3D CONSTRUCTION KIT	24.95
A-TRAIN (1MB)	24.95
ABANDONED PLACES 2 (1MB NOT1200)	23.95
ABANDONED PLACES 2 - A1200	24.95
ACTION SPORT (COMP)	21.95
ADRENALYN	6.96
AIR BUCKS V1.2 (1MB)	21.95
AIR BUCKS V1.2 - A1200 (1MB)	24.95
AIR SEA SUPREMACY (COMP) (NOT1200)	22.95
AIR SUPPORT	17.95
AKIRA	20.95
ALIEN 3 (1MB)	21.95
ALIEN BREED - SPECIAL EDITION '92 (1MB)	8.95
ALIEN BREED 2 (1MB)	19.95
ALIEN BREED 2 (AMIGA 1200)	21.95
ALLO ALLO	18.75
AMOS PROFESSIONAL (1MB)	37.95
AMOS PROFESSIONAL COMPILER (1MB)	24.95
ANCIENT ART OF WAR IN THE SKIES (1MB)	24.95
APACHE	6.96
APOCALYPSE	18.95
ARABIAN NIGHTS (1MB)	18.95
ARABIAN NIGHTS (AMIGA 1200)	21.95
ARKANOID II - REVENGE OF DOH	6.96
ARMOUR GEDDON 2	21.95
ARSENAL - THE COMPUTER GAME	18.95
ASSASSIN REMIX (1MB)	8.95
ATAC (1MB)	24.95
ATOMINO	9.95
B-17 FLYING FORTRESS (1MB)	24.95
BAAL	7.95
BALLISTIX	7.95
BARDS TALE 3	8.95
BARDS TALE CONSTRUCTION KIT (1MB)	21.95
BATMAN - THE MOVIE	8.95
BATTLE CHESS	6.96
BATTLE ISLE '93	18.95
BATTLE TOADS	18.95
BIG RUN	15.96
BITMAP BROTHERS - VOLUME 1 (NOT600)	18.95
BLADE OF DESTINY (1MB)	29.95
BLASTAR (1MB)	18.95
BLOB (1MB)	18.95
BODY BLOWS (1MB)	19.95
BODY BLOWS (AMIGA 1200)	21.95
BODY BLOWS GALACTIC (1MB)	19.95
BODY BLOWS GALACTIC (AMIGA 1200)	21.95
BONANZA BROTHERS	15.96
BOROBODUR	9.95
BOSTON BOMB CLUB	7.95
BRIDES OF DRACULA	15.96
BUBBLE BOBBLE (NOT1200) (NOT600)	6.96
BUGS BUNNY	6.96
BURNING RUBBER (1MB)	18.95
BURNING RUBBER (A1200)	18.95
CAESAR (1MB NOT1200)	21.95
CAESAR DELUXE (1MB)	21.95
CAMPAIGN	24.95
CAMPAIGN 2 (1MB)	24.95
CAPTIVE 2	22.95
CARDIAX	9.95
CARRIER COMMAND (NOT1200)	7.95
CASTLES 2 - A1200	24.95
CATCH 'EM	13.95
CENTURION	8.95
CHAMPIONSHIP MANAGER '93 (1MB)	18.95
CHAOS ENGINE (1MB)	18.95
CHASE HQ II	7.95
CHESS CHAMPION 2175	15.75
CHESSMASTER 2100 (1MB)	12.95
CHUCK ROCK	10.95
CHUCK ROCK 2 - SON OF CHUCK (1MB)	18.95
CIVILIZATION (1MB)	24.95
COMBAT AIR PATROL (1MB)	21.95
COMBAT CLASSICS (1MB)	21.95
CONTRAPTIONS	12.95
COUNT DUCKULA	6.96
COUNT DUCKULA 2	6.96
CRAZY SEASONS	18.95
CREEPERS	21.95
CRYSTAL KINGDOM DIZZY (NOT1200)	10.50
CURSE OF ENCHANTIA (1MB)	24.95
CYBERBLAST	15.75
CYBERSPACE (1MB)	24.95
DALEK ATTACK	13.95
DARK QUEEN OF KRYNN (1MB)	24.75
DAS BOOT	12.95
DENNIS	18.95
DENNIS (AMIGA 1200)	20.95

Please note

NOT+ means software is not compatible with the 500 Plus, 600 or 1200

DESERT STRIKE	21.95
DEVIOUS DESIGNS	9.95
DIZZY COLLECTION	18.75
DOG FIGHT (1MB)	24.95
DONK	12.95
DREADNOUGHTS	25.99
DREADNOUGHTS - BISMARCK	12.95
DREADNOUGHTS - IRONCLADS	12.95
DREAMWEB (1MB)	24.95
DUNE II (1MB)	22.95
DYNA BLASTER (NOT1200)	22.95
EASY AMOS (1MB)	24.95
ELITE II - FRONTIER	29.95
ERIK	6.96
EUROPEAN CHAMPIONS	18.95
EUROPEAN CHAMPIONSHIPS 1992	13.95
F-16 COMBAT PILOT (NOT1200)	7.95

CD32



£299.99

F17 CHALLENGE (1MB)	10.95
FALCON	7.95
FALCON - COUNTERSTRIKE DATA DISK	7.95
FALCON - FIREFIGHT DATA DISK	7.95
FANTASTIC WORLDS (COMP) (NOT1200)	25.99
FATAL STROKES	21.95
FINAL COUNTDOWN	6.96
FIRE HAWK	15.75
FIRST DIVISION MANAGER (NOT600)	6.96
FLASHBACK (1MB)	22.95
FOOTBALL DIRECTOR 2 (1MB)	7.95
FOOTBALL MANAGER 3	18.95
FORMULA 1 GRAND PRIX (1MB)	24.95
GALACTIC WARRIOR RATS	7.95
GAUNTLET II	6.96
GLOBAL GLADIATORS (1MB)	22.95
GNOME ALONE	18.95
GOAL (1MB)	22.95
GOBLINS 2 (1MB)	21.95
GRAHAM GOOCH WLD CLASS CRICKET (1MB)	21.95
GULP	21.95
GUNSHIP 2000 (1MB)	24.95
HAGAR THE HORRIBLE	15.96
HARDBALL	7.95
HEROQUEST	7.95
HEROQUEST 2	18.95
HIRED GUNS	21.95
HISTORY LINE (1914-1918) (1MB)	24.95
HOI	14.95
HOME ACCOUNTS 2	29.95
HUCKLEBERRY HOUND	7.95
HUMANS - Jurassic Levels (Data Disk) (NOT1200)	10.50
HUMANS - Jurassic Levels (Stand-alone)	21.95

MICRO MACHINES	15.75
MICROPROSE GOLF (1MB)	24.95
MORPH (1MB NOT1200)	18.95
MORPH (AMIGA 1200)	18.95
MR NUTZ (AMIGA 1200)	20.95
NAVY MOVES	6.96
NICK FALDOS CHAMPIONSHIP GOLF (1MB)	24.95
NIPPON SAFES INC	21.95
NOODY'S BIG ADVENTURE	18.75
NOODY'S PLAYTIME (1MB)	18.75
NORTH & SOUTH	6.96
OMAR SHARIF'S BRIDGE (1MB)	24.95
ONE STEP BEYOND	15.75
OPERATION HARRIER	7.95
OUTLANDER	22.95
OVER THE NET	9.95
OVERDRIVE (1MB)	19.95
PANG (NOT600)	6.96
PANZA KICK BOXING	7.95
PARASOL STARS (1MB)	13.50
PEN PAL	39.95
PERFECT GENERAL (1MB)	24.95
PERFECT GENERAL - WW2 DATA DISK (1MB)	15.75
PGA TOUR GOLF PLUS	21.95
PINBALL FANTASIES (1MB)	21.95
PIRATES	10.95
PIXIE & DIXIE	7.95
PLATINUM (COMP)	15.96
POPEYE 2	6.96
POPEYE 3	7.95
POPULOUS II - DATA DISK	8.00
POPULOUS II PLUS (1 MEG) (1MB)	24.95
POPULOUS/PROMISED LANDS	10.95
POSTMAN PAT	6.96
POSTMAN PAT 3	6.96
POWER UP (COMP)	12.95
PREMIER MANAGER	18.95
PREMIERE (1MB NOT1200)	22.95
PRIME MOVER	21.95
PRINCE OF PERSIA	6.96
PROJECT X - NEW VERSION (1MB)	10.95
PSYBORG	9.95
PUFFY'S SAGA	6.96
QUATTRO POWER MACHINES (COMP)	6.96
QWAK	8.95
R.B.I. BASEBALL 2 (NOT+)	6.96
RAGNAROK	29.95
RAINBOW ISLANDS	6.96
RAMPART (1MB)	14.50
REACH FOR THE SKIES	22.95
ROAD RASH	18.95
ROOLAND	7.95
ROLLING RONNY (NOT+)	14.95
ROOKIES (1MB)	18.95
RUBICON	15.96
RUGBY COACH	9.95
RYDER CUP	18.95
RYDER CUP (AMIGA 1200)	18.95
SABRE TEAM (1MB)	13.50
SABRE TEAM - A1200	21.95
SAMURAI - WAY OF THE WARRIOR	17.95
SCRABBLE	20.95
SECRET OF MONKEY ISLAND II (1MB)	27.95
SENSIBLE SOCCER 92/93	18.95

SWITCHBLADE II	7.95
SWIV	7.95
SYNDICATE (1MB)	24.95
T.N.T. 2 (COMP)	21.95
TFX (AMIGA 1200)	24.95
THE GREATEST (COMP) (1MB)	24.75
THE PATRICIAN (1MB)	24.75
THE PLAGUE	6.96
THOMAS FUN WITH WORDS	15.75
THOMAS THE TANK ENGINE	6.96
THOMAS THE TANK ENGINE 2	6.96
TINY SKWEEKS	18.95
TOKI	7.95
TOTAL CARNAGE	20.95
TRIPLE ACTION PACK VOL.3	10.95
TRIPLE ACTION PACK VOL.4	10.95
TRIPLE ACTION PACK VOL.5	10.95
TRIVIAL PURSUIT	6.96
TROLLS (1MB)	18.95
TROLLS (AMIGA 1200)	18.95
TURRICAN II	6.96
TWILIGHT 2000	24.95
UNDER PRESSURE	9.95
VALHALLA (1MB)	21.95
WALKER (1MB)	21.95
WAR IN THE GULF (1MB)	21.95
WHALES VOYAGE	21.95
WHALES VOYAGE (A1200)	21.95
WHITE SHARKS	6.96
WONDER DOG	18.95
WOODYS WORLD	18.95
WORLDS OF LEGEND	18.95
ZOOL (1MB)	18.95
ZYCONIX	15.75

3.5" Disks



Qty	DSDD	DSHD
10	5.30	7.80
20	10.35	15.35
25	12.65	18.25
30	14.75	21.80
35	16.90	25.20
40	18.95	28.60
45	21.10	32.10
50	22.95	34.40
80	36.35	52.30
100	39.95	61.90
120	49.40	72.40
150	60.95	90.25
200	78.75	115.75
250	97.30	143.30
300	116.30	170.75
400	154.50	221.70
500	184.65	269.65
600	223.50	320.60
1000	364.30	524.40

All our disks are fully guaranteed and include labels.

Educational

CAVE MAZE	10.95
FRACTION GOBLINS	10.95
MATHS DRAGONS	10.95
PICTURE FRACTIONS	10.95
REASONING WITH TROLLS	10.95
TIDY THE HOUSE	10.95
ANSWER BACK JUNIOR QUIZ (6-11)	16.99
ANSWER BACK SENIOR QUIZ (12-AD)	16.99
FRENCH MISTRESS	16.99
GERMAN MASTER	16.99
ITALIAN TUTOR	16.99
MATHS ADVENTURE (6-14)	21.95
SPANISH TUTOR	16.99
MEGA MATHS (A LEVEL)	19.95
MICRO ENGLISH (8-GCSE)	19.95
MICRO FRENCH (BEGINNERS-GCSE)	19.95
MICRO GERMAN (BEGINNERS-GCSE-Business)	19.95
MICRO MATHS (11-GCSE)	19.95
MICRO SCIENCE (8-GCSE)	19.95
PRIMARY MATHS COURSE (3-12)	19.95
READING WRITING COURSE (6-8)	19.95
ALVINS PUZZLES	15.75
PAINT POT 2	15.75
SHOPPING BASKET	15.75
WHICH? WHERE? WHAT?	15.75
BETTER MATHS (12-16)	18.95
BETTER SPELLING (8-ADULT)	18.95
JUNIOR TYPIST (5-10)	13.95
MAGIC MATHS (4-8)	18.95
MATHS MANIA (8-12)	18.95
THE THREE BEARS (5-10)	18.95
ADI ENGLISH (11-12 or 12-13 or 13-14 or 14-15)	18.95
ADI FRENCH (11-12 or 12-13 or 13-14 or 14-15)	18.95
ADI JUNIOR COUNTING (4-5 or 6-7)	15.75
ADI JUNIOR READING (4-5 or 6-7)	15.75
ADI MATHS (11-12 or 12-13 or 13-14 or 14-15)	18.95
FUN SCHOOL 2 (UNDER 6 or 6-8 or OVER 8)	6.96
FUN SCHOOL 3 (UNDER 5 or 5-7 or OVER 7)	18.75
FUN SCHOOL 4 (UNDER 5 or 5-7 or 7-11)	18.75
MERLIN'S MATHS (7-11)	18.95
PRINT AND CREATE (OVER 5'S)	18.95
SPELLING FAIR (7-13)	18.95

DataGEM Games Centre

Mon - Fri 10am to 8pm
Saturday 10am to 4pm
2 mins from Old St. Tube - take exit 2

Try before you buy at mailorder prices



IK+	6.96
INDIANA JONES & FATE ATL. (ACT) (1MB)	18.95
INDIANA JONES & FATE ATL. (ADV) (1MB)	27.95
INDIANA JONES & L. CRUSADE (ADV)	12.95
INTERNATIONAL 5 A SIDE	6.96
INTERNATIONAL GOLF	6.96
INTERNATIONAL OPEN GOLF (1MB)	18.95
INTERNATIONAL OPEN GOLF (AMIGA 1200)	18.95
ISHAR 2 (1MB)	21.95
JAMES POND	6.96
JIM POWER	15.96
JOHN MADDEN'S FOOTBALL	18.95
JURASSIC PARK (1MB)	18.95
JURASSIC PARK (A1200)	20.95
KEYS OF MARAMON	9.95
KGB (1MB)	22.95
KICK OFF II (1 MEG)	18.95
KID PIX (NOT1200)	18.95
KILLING MACHINE	6.96
KINGDOMS OF GERMANY	21.95
KNIGHTS OF THE SKY (1MB)	24.95
LEGENDS	21.95
LEMMINGS 2 (1MB NOT1500)	21.95
LINKS - FIRESTONE	14.95
LIONHEART (1MB)	20.95
LOMBARD RAC RALLY	6.96
LOST VIKINGS	21.95
LOTUS III - THE ULTIMATE CHALLENGE (1MB)	18.95
LOTUS TURBO CHALLENGE II	7.95
MAELSTROM	24.95
MANCHESTER UNITED - PREMIER LEAGUE	21.95
MATRIX MARAUDERS	7.95
MAVIS BEACON TEACHES TYPING V.2 (1MB)	21.95
MEAN 18	7.95
MEAN ARENAS	18.95
MERCENARY 3	14.95

SHOE PEOPLE	7.95
SHOOT 'EM UP CONSTRUCTION KIT	7.95
SILENT SERVICE II (1MB)	24.95
SIM CITY DELUXE	25.99
SIM CITY/POPULOUS	21.95
SIM LIFE (1.5MB)	24.95
SIM LIFE (AMIGA 1200)	24.95
SIMON THE SORCERER (1MB)	24.95
SIMON THE SORCERER (A1200)	29.95
SLEEPWALKER (1MB)	21.95
SLICKS	6.96
SOCCER KID	21.95
SOCCER KID - A1200	21.95
SOCCER MATCH (NOT+)	6.96
SOOTYS FUN WITH NUMBERS	15.75
SOUP TREK	21.95
SPACE CRUSADE - DATA DISK	15.75
SPACE LEGENDS (1MB)	21.95
SPORTS MASTERS (COMP)	21.95
STAR BLADE	7.95
STARBUST (1MB)	13.95
STREET FIGHTER 2 (1MB)	20.95
STRIKE FLEET	10.95
STRIKER MANAGER	7.95
STRYX	7.95
STUNT CAR RACER	6.96
SUBURBAN COMMANDO (+ FREE FILM)	18.75
SUPER FROG (1MB)	19.95
SUPER HEROES (COMP)	17.95
SUPER LEAGUE MANAGER	18.95
SUPER MONACO G.P.	7.95
SUPER TETRIS (1MB NOT1200)	17.95
SUPERCARS II (NOT1200)	7.95
SUPERHERO (1MB)	21.95
SUSPICIOUS CARGO	12.95
SWAP	9.95

Hint Books

BANE OF THE COSMIC FORGE	12.99
EYE OF THE BEHOLDER I	7.99
EYE OF THE BEHOLDER II	9.99
INDIANA JONES & FATE ATL. (ADV)	9.99
INDIANA JONES & L. CRUSADE (ADV)	5.99
KNIGHTMARE	5.99
LOOM	7.99
MANIAC MANSION	7.99
SECRET OF MONKEY ISLAND	5.99
SECRET OF MONKEY ISLAND II	9.99

Hardware

A500 Expansion upgrade with clock	0.5Mb	27.95
A500 Expansion upgrade without clock	0.5Mb	24.95
A500plus RAM upgrade	1Mb	56.95
A600 Expansion upgrade with clock	1Mb	51.95
Parallel port extension cable		6.80
Parallel printer cable (2m)		8.60
Roboshift (Auto mouse/joystick switch)		14.75
Zi-Fi Stereo Speakers		37.95

Miscellaneous

4-Player adaptor	6.96
Head Cleaner (3.5")	3.75
Mouse	14.75
Mouse House	2.95
Mouse Mat	2.95
SCART cable	9.49
Workstation for 500 & 500+	42.95
Workstation for 600	37.95
Workstation for 1200	39.95
(Workstations include mouse mat, mouse house and dust cover)	

AccuTrans 3D

If you want to convert your 3D ray-traced objects from one format to another, then AccuTrans 3D could be the answer. Richard Baguley puts the object converter program through its paces...

RAY-TRACING PROGRAMS

such as *Imagine 2* and *Real 3D Version 2* are capable of producing stunning results, and provide a great number of powerful tools for producing your 3D models.

Unfortunately, the different programs have different ways of saving files, and these aren't interchangeable. This is where a program such as *AccuTrans 3D* comes in. This program can take 3D models produced by any one of five different programs, and save them out into any other format. So, for instance, you could take all your old *Sculpt-Animate 4D* models and convert them for use in *Imagine 2*.

When you're converting, you never actually see the object. Instead, you're presented with a button-strewn control panel, where you set the various aspects of the conversion. You are given an impressive degree of control over the process, including the ability to rescale objects, split objects into their various parts and save these individually.

It's pretty obvious that this program is aimed mainly at users of CAD programs such as *AutoCad* and *X-CAD*, and for them this program could be extremely useful, as they could produce proper ray-traced images of the objects or buildings they have built. It's also useful for other users,



This image began life as a DXF file produced in *AutoCad*. It was then converted to an *Imagine* file using *AccuTrans* and rendered.

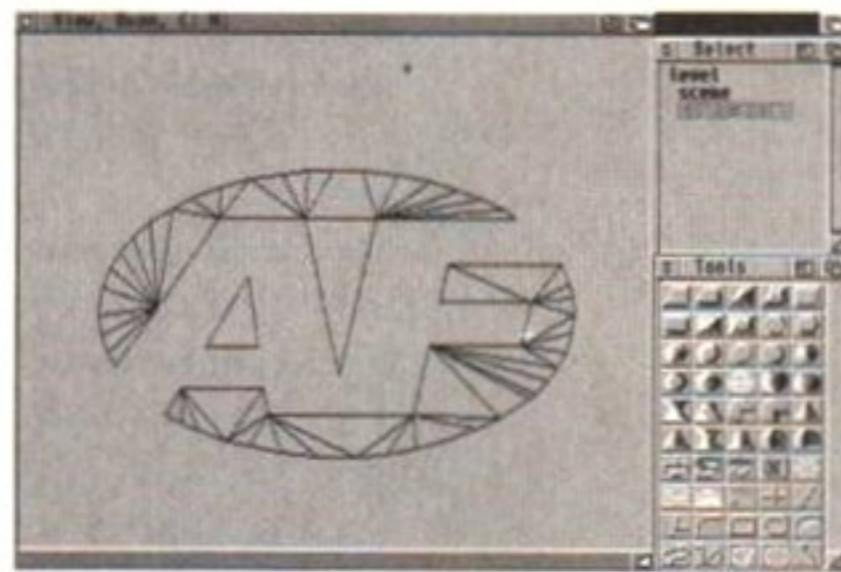

The logo was converted from *Imagine* to a *Sculpt* object using *AccuTrans*.

but the list of supported formats could do with being extended to include some of the more obscure programs which still pop up occasionally (such as *Draw 4D* and *Aladdin 4D*).

The obvious competition for this program is *Pixel 3D Professional*, which supports one more format (*3D Professional*), and also has an ARexx port, making automating processes much easier.

Pixel 3D Professional is slightly faster, taking 30 seconds to load a typical DXF file, as against 35 seconds for *AccuTrans 3D*. *Pixel 3D* costs around £150, and *AccuTrans 3D* should cost you around £60, including shipping costs. *Pixel 3D* is definitely the more powerful program, with the ability to manipulate the objects you've loaded in a variety of ways, but if all you want is to convert objects from one format to another, *AccuTrans 3D* is definitely worth considering.

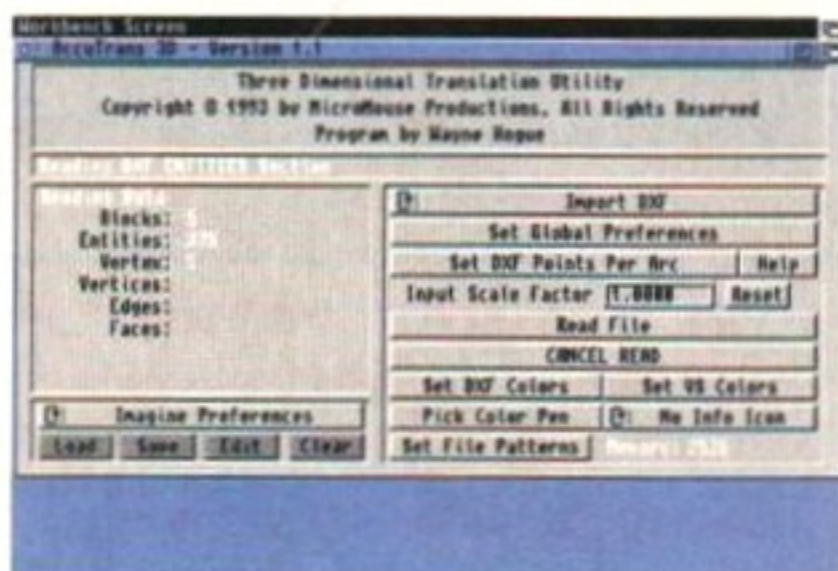

Here *AccuTrans 3D* is in the process of reading in a DXF file, before saving it out in any of the five supported formats.

FORMAT CHECK

AccuTrans can cope with 3D objects in the following formats: DXF - A standard for 3D models produced by CAD programs such as *XCAD* or *AutoCad*.

Imagine - Produced by Impulse's *Imagine* and *Turbo Silver*.

Lightwave - Produced by the *Lightwave 3D* ray-tracing program bundled with the Video Toaster.

VideoScape - Produced by the old but widely used 3D program *VideoScape 3D*.

Sculpt 4D - Produced by *Sculpt-Animate 4D*, once the best ray tracing program, but not recently updated.

ACCUTRANS 3D

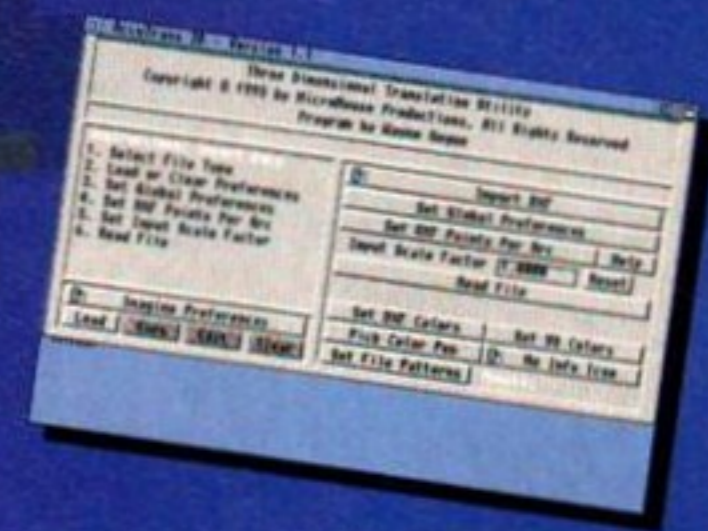

DESCRIPTION

3D object converter program.

MANUFACTURER

Micro Mouse Productions

DISTRIBUTOR

Micro Mouse Productions

0101 306 522 6077

PRICE

\$60.00

RELEASE

Out now

SPEED

Slightly slower at loading and saving than *Pixel 3D*, but fairly fast.

MANUAL

In-depth and covers all aspects of the program.

ACCESSIBILITY

Good on-screen help enables you to get into the program quickly.

FEATURES

It's certainly not as feature laden as *Pixel 3D*, but does its job well.

VALUE

Less powerful than *Pixel 3D*, but much cheaper.

VERDICT

"AccuTrans 3D is not as powerful as Pixel 3D, but it could be extremely useful for use with CAD programs. However, the list of supported formats could do with being extended"

80%

QuarterBack TOOLS DE LUXE

Nick Veitch investigates the latest version of the disk and data repair and recovery program.

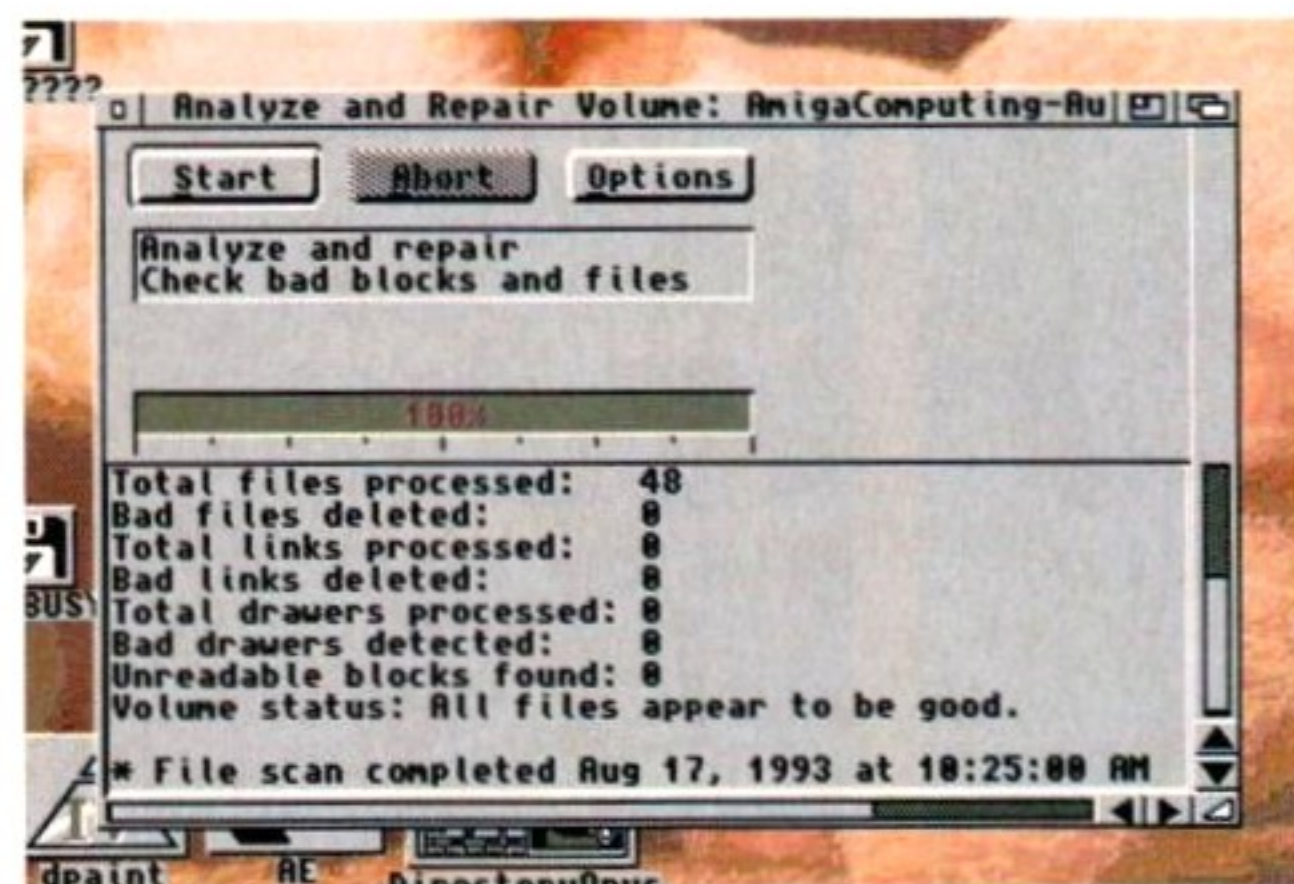

IT MIGHT BE a life's work, it might be an irreplaceable database of phone numbers, it might even be a file containing the number of your boss's secret Swiss bank account – everybody who uses a computer must have lost a highly important file at some time in their life.

At such times, all Amiga cognoscenti reach for their Workbench disks, find the amazing *DiskDoctor* program... and delete it. The sad reality is that Commodore's *DiskDoctor* is a quack and a sawbones – when it comes to the health of your important disks, it's best to go private.

Choosing between the applicants for the position of saviour of all your data is not an easy task. There are several contenders, from the PD delights of *DiskSalve* and *FixDisk*, to commercial offerings such as *Disk Mechanic* and *AmiBack*. But the most popular practitioner has always been *Quarterback Tools*. In spite of the failings of earlier versions it has remained the most popular choice by virtue of being the most successful at recovering errant data blocks.

This latest version differs quite considerably from its ancestors in terms of layout. *QBTools* now defaults to a Workbench window, with a choice of four buttons and a device list to select the disk to be examined. Once a disk is selected, you can then choose what to do with it. This breaks down into four sections: Repair, Recover, Optimize and Edit. Repairing is for disks which have logical errors on them – invalid

A full analysis of your disk's state of health checks not only for the obvious bad blocks, but for invalid links between them.

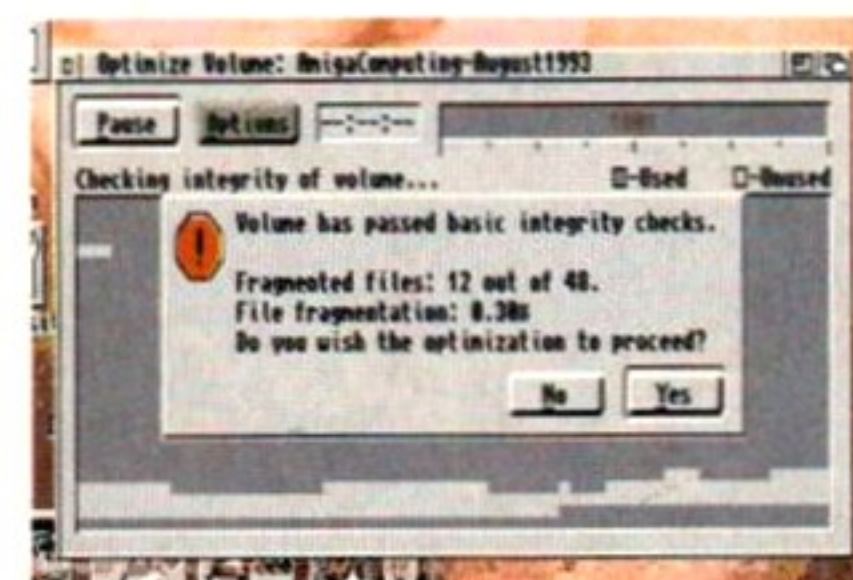

Optimizing a disk can save a lot of access time, especially on valuable things like AF Coverdisks...

bitmaps, bad checksums, knackered headers – the sorts of things which occasionally happen when your Amiga decides to guru during a disk operation. Recover is useful for reconstructing files which have been accidentally or otherwise deleted.

Optimizing a disk is a process where all the files are defragmented. As disks are used and the files on them are deleted, renamed, and updated, the blocks that make up the data can no longer be stored in one continuous stream of adjacent sectors on the disk. When this happens it takes the Amiga longer to access the data, as it is constantly moving the heads backwards and forwards over the disk to locate all the blocks. Optimization straightens out all the files, making for faster access times.

The only really new part is the Edit function, a *Newszap*-style hex editor which enables you to edit individual blocks of data by hand. This can be quite useful indeed, but only if you know what you are doing. A full explanation of the intricacies of disk structures is a bit beyond the scope of the accompanying manual.

Rather unfortunately for *Quarterback Tools*, and more importantly, unfortunately for me, the latest version of the Repair program seems to have a few bugs in it. When presented with (as far as I know) a perfectly functioning disk during tests, it became convinced that it had a number of problems. This wouldn't have been so bad, except that it then went through three recoverable alerts before finally gurning in the middle of attempting to repair these phantom ailments. As a result I fear my disk will never be the same again.

Even more unfortunately for all parties concerned, I then tried to optimize a disk. After the initial scan, the program (correctly) informed me that the disk was 0.00% fragmented. All well and good, but it then offered me the chance to proceed. Foolishly, I thought the software might stop short of going through a long and tedious process to optimize a disk which was already as optimized as it was ever going to get. Not only did *Quarterback Tools* go through said lengthy and tedious process, but it had the cheek to tell me after five minutes that the operation had failed and that I may have lost some files. The faults were fixed and files recovered using the old version of *QBTools*. Progress, eh?

The *De Luxe* tag to *Quarterback Tools* applies to all the extra bits that come on the disk, which include a few gems such as *Locator*, a useful program, especially since AmigaDOS's programmers didn't include a Find command. *Locator* initiates a quite complicated search string and then traces all the occurrences, giving full pathnames, the size and the date the file was created. Also included is *System Mover* which transfers types of file, fonts, libraries and devices from one disk to the other without having to use the Shell.

Overall the upgrade makes the program a bit more Amiga-friendly, and easier to use, but, it seems, at the expense of being an efficient recovery system. Save money and stick to the old version.

QUARTERBACK TOOLS DELUXE



DESCRIPTION

Disk and data repair and recovery

MANUFACTURER

New Horizons

DISTRIBUTOR

1st Comp Centre 0532 319444

PRICE

£69.99

RELEASE

Out now

SPEED

Quite fast compared to the competition. Optimization is a tad slow.

MANUAL

Well produced 86-page manual details every function.

ACCESSIBILITY

Now in improved Workbench-friendly version, it is easier to use.

FEATURES

It's got them all – it's just a shame they don't work some of the time.

VALUE

There are some useful functions, but just too many problems.

VERDICT

“ It has lots of new bits but the important parts of the program simply don't work properly. Seventy quid for a piece of software that exhibits flaws such as these is asking a bit too much. ”

54%

New Horizon Computers

The Hard Drive Specialist

Amiga 1200/Hard Drive THIS MONTH'S SPECIAL OFFERS

80 MEG
£465.00
INC VAT & DELIVERY

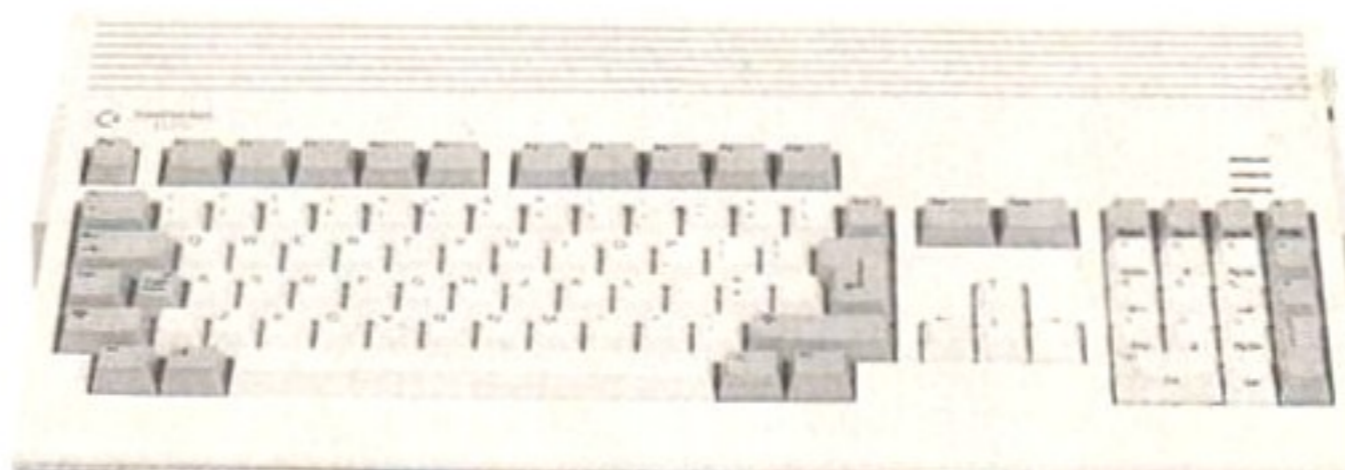

40MEG
£389.00
INC VAT & DELIVERY

**Other
Sizes Available
Call for Latest Prices**

**INCLUDES 2 YR
EXTENDED WARRANTY**

HARD DRIVE DIY KITS FOR A1200 OR A600

INCLUDES HD TOOL BOX AND INSTALL 3.0/2.0

PHONE FOR LATEST LOW LOW PRICES

20, 40, 63, 80, 85, 128, 137 & 210 Meg in Stock Now !!!

☆☆☆ INSTALLATION ☆☆☆

New Horizon will collect your Amiga, fit the drive of your choice and deliver it back to you within 48 hours. Full 12 month RTB Warranty on your Computer when we install the drive. Wang UK carry out our repairs. Phone our Sales Hotline for further details.

☆☆☆ SPECIAL OFFER ☆☆☆

MONITORS



MODEL	SIZE	DOT	RES	SOUND	SCAN	PRICE
Philips 8833 Mk II	14"	.31	LOW	YES	15KHZ	POA
Commodore 1084 ST	14"	.31	LOW	YES	15KHZ	POA
Commodore 1960	14"	.31	MED	NO	MULTI	POA
Commodore 1940	14"	.39	MED	YES	DUAL	POA
Commodore 1942	14"	.28	MED	YES	DUAL	POA
Microvitec Cubscan	14"	.31	MED	NO	MULTI	POA
New Horizon Vanilla	15"	.28	HIGH	NO	MULTI	POA
New Horizon Vanilla	17"	.31	HIGH	NO	MULTI	POA

A1200 BLIZZARD

32 BIT TRAPDOOR MEMORY AND FPU ACCELERATORS

Includes Real Time Clock and Zero Wait State Memory

MODEL	CONFIGURATION	PRICE
A1200/4	4 MEG 32 BIT FAST MEMORY	£179.00
A1200/4A	4 MEG PLUS 14 MHZ 68881	£228.00
A1200/4B	4 MEG PLUS 20 MHZ 68882	£258.00
A1200/4C	4MEG PLUS 33 MHZ 68882	£278.00
ADD4	ADDITIONAL 4 MEG MEMORY	£159.00

HOW TO ORDER



1. By Phone. Next Day Delivery on small items please add £5.00. Next Day Delivery on computers, Monitors and Printers add £12.00



2. By Post. Send a cheque or Postal Order made payable to New Horizon Computers and post with your order to

New Horizon Computers (Mail Order)
High Hope, Lee,
Ross on Wye, Herefordshire HR9 7LN

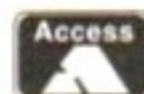

CREDIT CARDS WELCOME



SALES HOTLINE 0989 750260 TECH SUPPORT 0989 750337

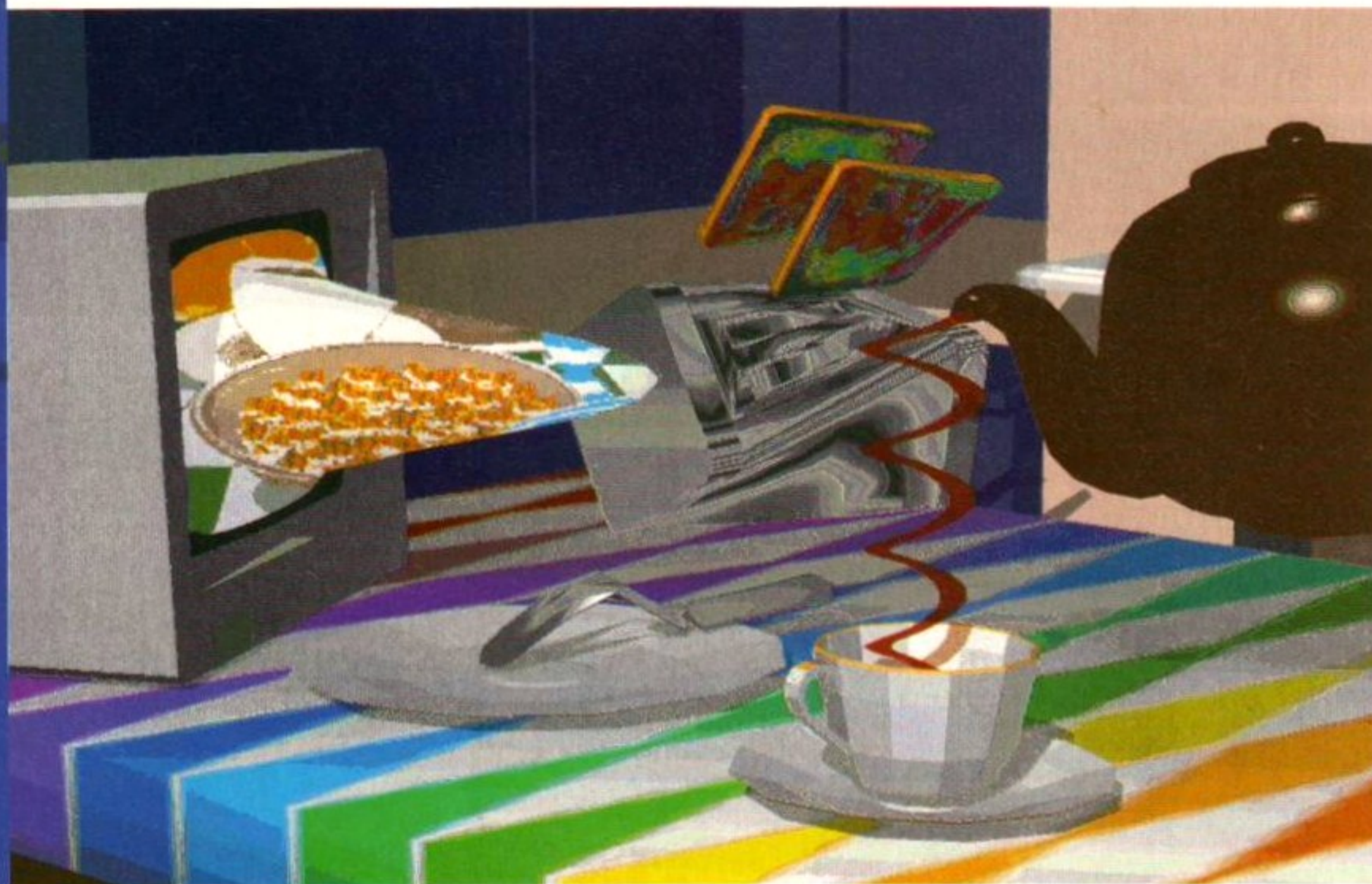

Caligari24

THIS ONE HAS come a long way since we reviewed *Caligari2* in May 1992. Octree's concentration on a *Broadcast* version has always left the 'consumer' version lagging behind other 3D packages, but this new version has some fine abilities in addition to its famously simple interface, not least its amazing render speed.

No longer can you say of *Caligari* that it's all mouth and no trousers – a superb front end, but no real performance in the

ABOVE: Free Form Deformation (FFD) was used for the TV screen, the toaster and the knife. The toaster here was twisted by selecting one end of its bounding box and rotating it around the main horizontal axis.

vital areas of modelling or rendering. *Caligari24* now has much more impressive goodies, not least among them the facts that it now supports the AGA screen modes for A1200 and A400 owners, and works in only 2Mb of RAM.

As ever, the thing that dominates your impression of *Caligari* is the magical interface. After six or seven years, it is still by far the best on any graphics program.

Always one sandwich short of a picnic in the past, *Caligari's* lunchbox now seems to be filled with an appetising array of goodies. Brian Larkman tries the taste of the update.

All the features are controlled by a series of push-button toolboxes at the bottom of the screen. These are a mix of icons and word-labels leaving the user in no doubt of the function of each.

The real power, however, lies in the intuitive way that objects and scenes are moved, rotated and transformed: in full 3D perspective, in a three-quarter view, in real time, using just the mouse. Easy! The movement is so smooth that it really feels as though the mouse is the object.

Smooth movement can be had by all because *Caligari* uses a version of the 'bounding box' system. Beyond a certain threshold, complex objects are moved in the form of the smallest rectangular box that will contain the objects – the bounding box. Since only a simple 3D rectangle is actually being moved in real time, changes to the scene are smooth and easy to perform, with the full scene redrawing as soon as the mouse button is released.

This sort of simplicity has now been extended into the whole modelling interface so that lines, faces and parts of objects can be rotated, scaled and moved just as easily as complete objects and scenes, making detailed editing easy.

Other editing tools are added in this version so that objects can be sliced and faces extruded simply, though complex extrusions and lathe operations on complete objects are still quite rudimentary.

Caligari24 allows images to be rendered and saved in 32-bit, the extra eight bits being used for degrees of transparency. That is especially useful if the image is to be genlocked with live video, because the live video can show through the transparent objects.

Only a few display boards, such as the ACS Harlequin, can handle the extra 8-bit Alpha channel. Some programs claim to use an Alpha channel – *ADPro* from ASDG and *OpalPaint* from Centaur – but this is only a pseudo-Alpha channel in software. Though the concept is similar – and very useful – only a 32-bit board can give a true real-time hardware Alpha channel.

USING THE ALPHA CHANNEL



1 What we're going to do here is simulate the effect of using transparent Alpha channel objects with live video showing through them. Instead of live video, though, we're going to be using the 24-bit background view pictured here. This static image could quite easily be replaced with live video genlocked in.



2 The rendered image produces a black area where the background is to appear. All transparent objects (the glass vase for example) are rendered with an extra eight bits (256 shades of grey) in addition to the 24-bit colour used for the rest of the picture. This provides information for the degrees of tinting (transparency) to use for the live video behind these areas.

The most exciting modelling feature added is Free Form Deformation (FFD). This process extends the principle of the bounding box so that a rectangular or cylindrical lattice 'bounding' an object can be deformed easily in real time. This deformation is then transferred to the full object before it is redrawn.

For greater precision, the box can be subdivided as many times as you like. Any number of crossing points on the grid, or even whole faces, can be selected and deformed with ease. For example, the TV screen in the main illustration was 'bulged' by dragging the centre point of one side of its bounding box. The screen bulged to follow the bounding box.

This is one of those functions that sounds complicated when you try to explain it in words but is dead simple in practice. It's brilliant. Using FFD, complex organic shapes are easy and animated distortions like the famous warping Nova ad should be within the reach of all. As usual however, animated FFD distortions are only possible on the hugely expensive *Broadcast* version. Will Octree ever learn?

Animation in general is crude in *Caligari*, but as a consolation, it's very easy to set up. Only 'key-frame' animation is available, so any object or hierarchical sub-object can be moved, rotated or scaled over a series of frames.

Paths can be straight vectors or spline curves, but acceleration and deceleration, object heading (along a curved path), and other sophisticated effects have to be created manually within the key frames or produced using scripts. As for morphing, waves, directed forces, collision detection or particle animation, just forget it.

Although types of animation available are very limited, synchronisation of the various objects and sub-objects is made much easier by the new Time Editor. Using hori-



The knife is quite tricky to distort using Free Form Deformation, because it does not have enough faces. This has meant its twist is far too sharp and angular - add more faces, and it would turn out fine.

zontal time bars to represent the duration of motion events for each object, this provides a simple, visual way to fine-tune the various components of an animation.

Key frames of your animation can also be moved, deleted, and copied interactively directly in this editor.

Rendering is almost unchanged from *Caligari2* except for the ability to render to most makes of frame-buffer in 24-bit or 32-bit. *Caligari* is not a ray-tracer, which means that it uses a whole series of tricks to produce photo-realistic images, including environment maps to give convincing reflections and shadow volume algorithms for shadows.

Although rendering is wickedly fast using these scan-line techniques, they assume that the user has a greater understanding of the 3D model and shading methods than is needed for ray-tracing. In effect, you need to do lots more experiments to get things right, a process which is bugged by the lack of detailed tutorials.

True realism is also limited by the lack of flashy effects like bump maps, soft shadows, depth of field and motion blur, but these would kill the fast rendering times. To make up for this, *Caligari24* allows images to be rendered and saved using 32 bits of data.

The extra eight bits on top of the normal 24-bit image are used to store degrees of transparency, especially useful if the image is to be genlocked with live video, allowing transparent objects to show the live video through them.

Rendering is still a bit of a disappointment, lacking the sophistication and simplicity of ray-tracing. But then this program is built for speed, not realism.

To sum up, modelling in *Caligari* is greatly improved by the Free Form Deformation system, but still lags behind *Imagine* and *Real3D* for custom-built tools for special building jobs. Despite the new Time Editor, animation is now really quite pathetic compared to other packages - even the old *Sculpt3D*, which had morphing at least six years ago.

Rendering is almost unchanged except for the obvious improvements of 24-bit rendering, and it is still amazingly fast. For some jobs, this speed, coupled with the brilliant interface, make *Caligari24* the best system to use - just so long as you don't expect it to come through with too much in the trouser department.



3 The final image shows how the background blends into the rendered foreground allowing the sky and mountains to show through the glass vase in a realistic way. Because 256 greyscales are used, the blend can be very subtle indeed and the whole effect works particularly well when the background is live video rather than a static picture.

CALIGARI24



DESCRIPTION

3D modelling and rendering

MANUFACTURER

Octree

DISTRIBUTOR

Amiga Centre Scotl'd 089-687 583

PRICE

£299

RELEASE

Available now

SPEED



Still by far the fastest 3D renderer you can buy, but not a ray-tracer.

MANUAL



Reasonable description of functions but very few tutorials.

ACCESSIBILITY



Beautiful, well laid-out control panels. The one to emulate.

FEATURES



Good, but still not as good as the competition - but FFD is brilliant.

VALUE



With animated FFD it would be good. Without, it's reasonable.

VERDICT

" This latest version gives the fastest 3D rendering around, is ridiculously easy to use and the Free Form Deformation feature is excellent. It has its faults, but if you need speed, this is the one. "

85%

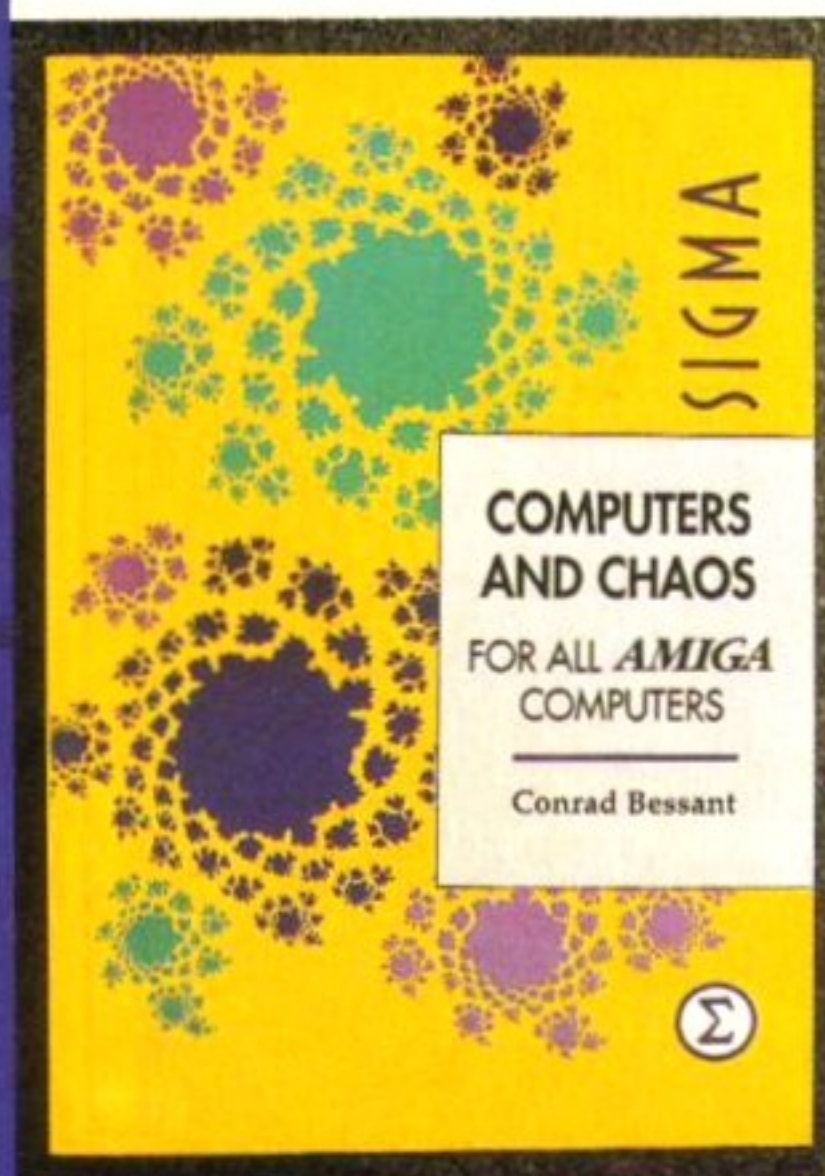

Computers and chaos combined? It all sounds rather too much like the Amiga Format office to be fun.

Book SHELF

Three new additions to the enormous library of Amiga books, brought to you by Tim Smith.

CONRAD BESSANT, SO

the blurb on the back of this book states, 'is a regular contributor to *Amiga Shopper*'. This gives him a great deal of credibility until you realise that what this blurb actually means is 'Conrad Bessant once wrote a series of articles about chaos for *Amiga Shopper* and that was six months ago'. Mmm.

And worse follows. The first paragraph of the opening chapter hits you in the face with a bunch of half-baked theology, dodgy grammar, and laughable reasoning. The best advice here is to

forget Conrad's reasoning and leap straight into the heaps of type-in listing that make the rest of the book useful, if a lot like a GCSE course book. There are lots and lots of Basic listings to be typed in, including simple fractal generators, Mandelbrot sets, Julia Sets and many others.

Once you've typed them all in, you can pick up a paperback version of James Gleik's seminal book *Chaos* if you want a whole-baked version of this complex theory. All in all, a useful tome for people who love type-ins. ☺

COMPUTERS AND CHAOS

DESCRIPTION

Chaos type-ins and explanations

AUTHOR

Conrad Bessant

PUBLISHER

Sigma

PRICE

£12.95

VERDICT

"Ignore the babble about chaos theory and type in the reasonably fun programs."

50%

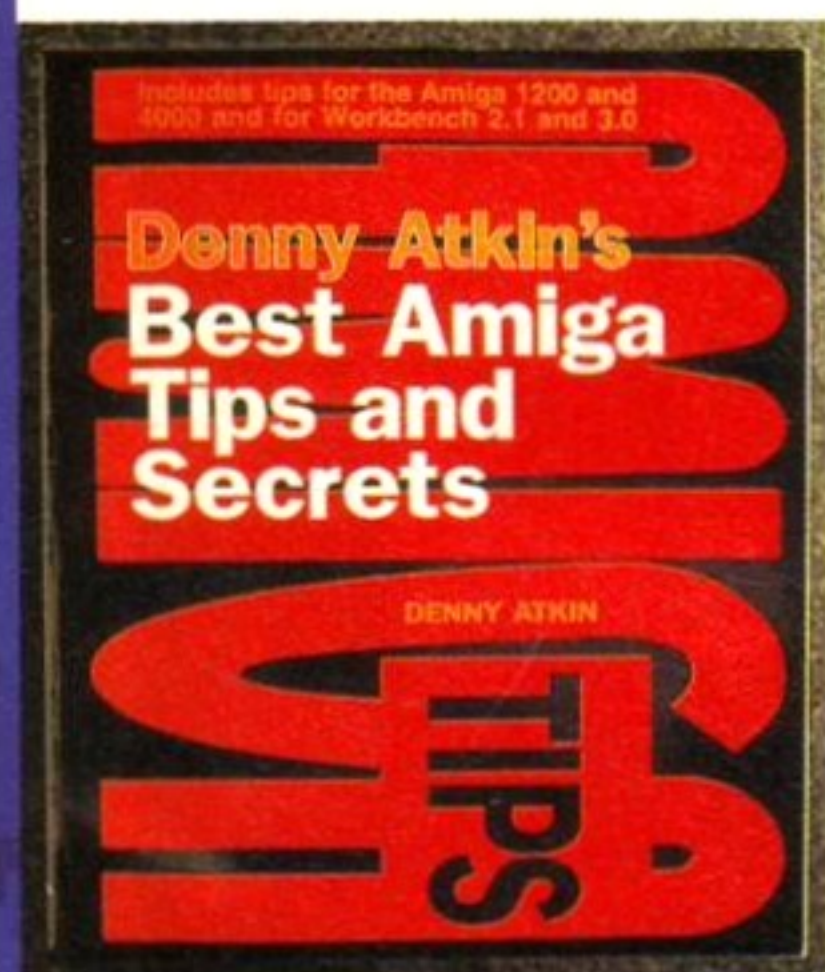

It's big, it's bold and it's beautiful. Denny Atkin knows Amigas well and loves to share his knowledge with you.

THIS LAD IS into Amigas in the way Casanova was into 'liaisons' - he loves them with a passion. Denny bubbles with enthusiasm and also offers lots of useful advice.

For example, did you know that you could cut and paste text from the Shell? Were you aware that you can switch the graphics handling away from the Blitter and into the CPU (which should be quite a bit faster if you're using an '040-based machine) with a neat little piece of Shareware?

Every page of this book is written in an easy style, conveying snappy little gobbits of information, although I would have liked to have seen the publishers' editor (assuming they have one) nipping through this UK version of the book and doing a rough pound-to-dollar exchange, although that's a

small gripe. Without doubt, there is tonnes of information bursting to get out of this book - everything from comms and Workbench to graphics and Shell. The only thing you won't find a great deal about is games, although there are occasional joystick references.

This is a useful book but it happily sidesteps dull worthiness by using sub-titles such as *I Think I'm A Clone Now* (describing the Clone Option in Shell) or *Copy All the Files Here - Not!* Again, thankfully Denny only lets his own sense of humour intrude occasionally as a lightener rather than an 'aren't I great dude!' irritation.

An excellent dip-in-and-read reference, it's just a shame that the publishers didn't do an English 'translation'. That Denny Atkins? Diamond geezer. ☺

DENNY ATKIN'S BEST AMIGA TIPS AND SECRETS

DESCRIPTION

Well-presented hints and tips

AUTHOR

Denny Atkin

PUBLISHER

Compute Books

PRICE

£18.45

VERDICT

"Well worth getting hold of. An excellent insider's guide to the Amiga."

92%

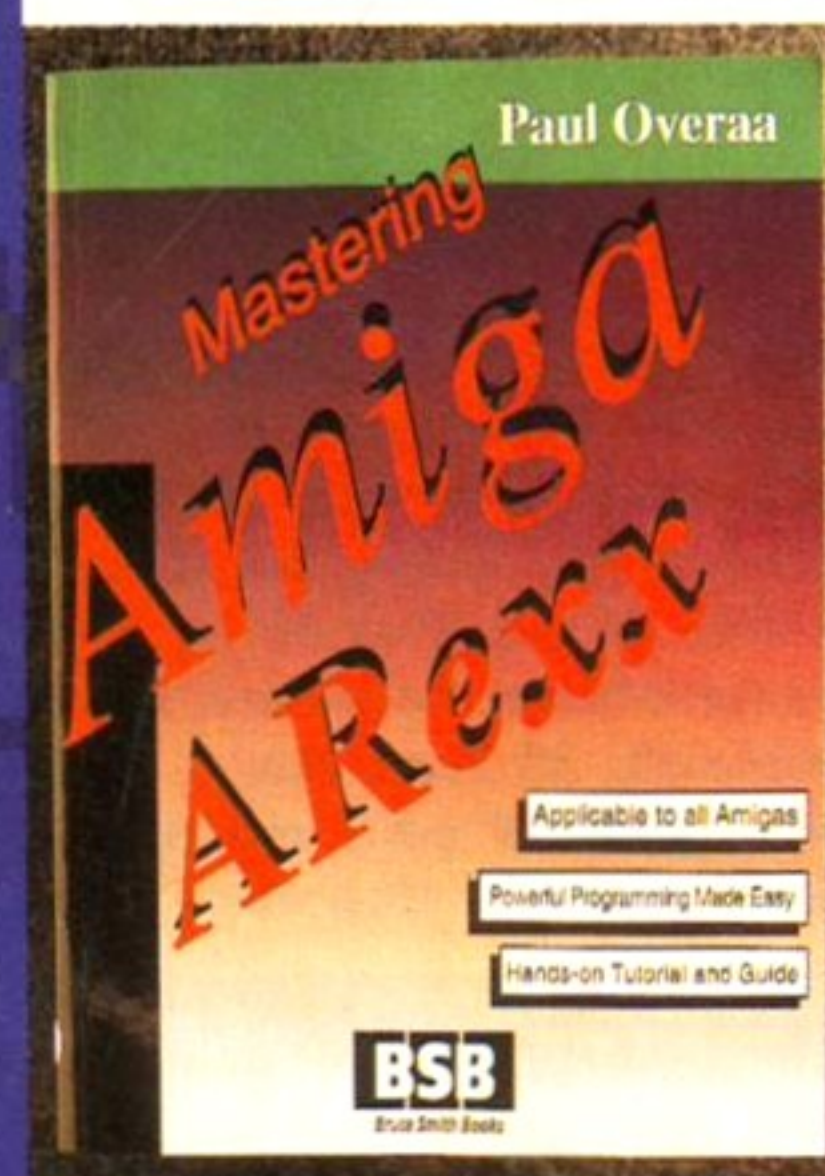

Get inside the bowels of your machine and, well, move things around with the wonderful ARExx.

"PAUL OVERAA whose technical expertise is frequently used by a great many computer magazines including *Amiga Format*," it says here. Not again! The last time we used Paul Overaa was in Issue 13! Three years ago! Doah! It's the blurb writers from hell!

Fortunately for all of us, though, Mr O doesn't bother with any half-baked philosophising in this too-expensive reference to the Amiga's hidden programming gem, ARExx. He just leaps into the fray with some reasonably presented listings and advice.

ARExx, as we all know, is the Amiga version of the REXX programming language that Commodore has seen fit to adopt as part of Workbench.

ARExx is a specialised area that Paul seems to understand on a solid level. His style is dry and

effective, if a little on the tediously studious side. This is not a book for the occasional ARExx user. However, it is about time that someone put together a guide to ARExx. This guide goes into installing ARExx, a look at the main features and a comparison with other languages such as Basic. As well as this it serves as an adequate introduction to some of the more advanced programming techniques that ARExx makes available to you, together of course with a few obligatory type-ins!

You certainly won't read this in bed - and of course, it obviously wasn't written with that in mind. But one thing's for sure, if you do read it from cover to cover, you'll be able to get a larger chunk of value from your Amiga than you had before, and that's nothing to sniff at. Worthy and useful. ☺

MASTERING AMIGA AREXX

DESCRIPTION

Practical guide to ARExx

AUTHOR

Paul Overaa

PUBLISHER

Bruce Smith Books

PRICE

£21.95

VERDICT

"It's good, but at £21.95 for a black-and-white book with no pictures it ain't cheap."

70%

X-Stitch DESIGNER V3

A surprisingly popular hobby, cross-stitch is a natural for Amiga adaptation, as Steven Jenkins explains...

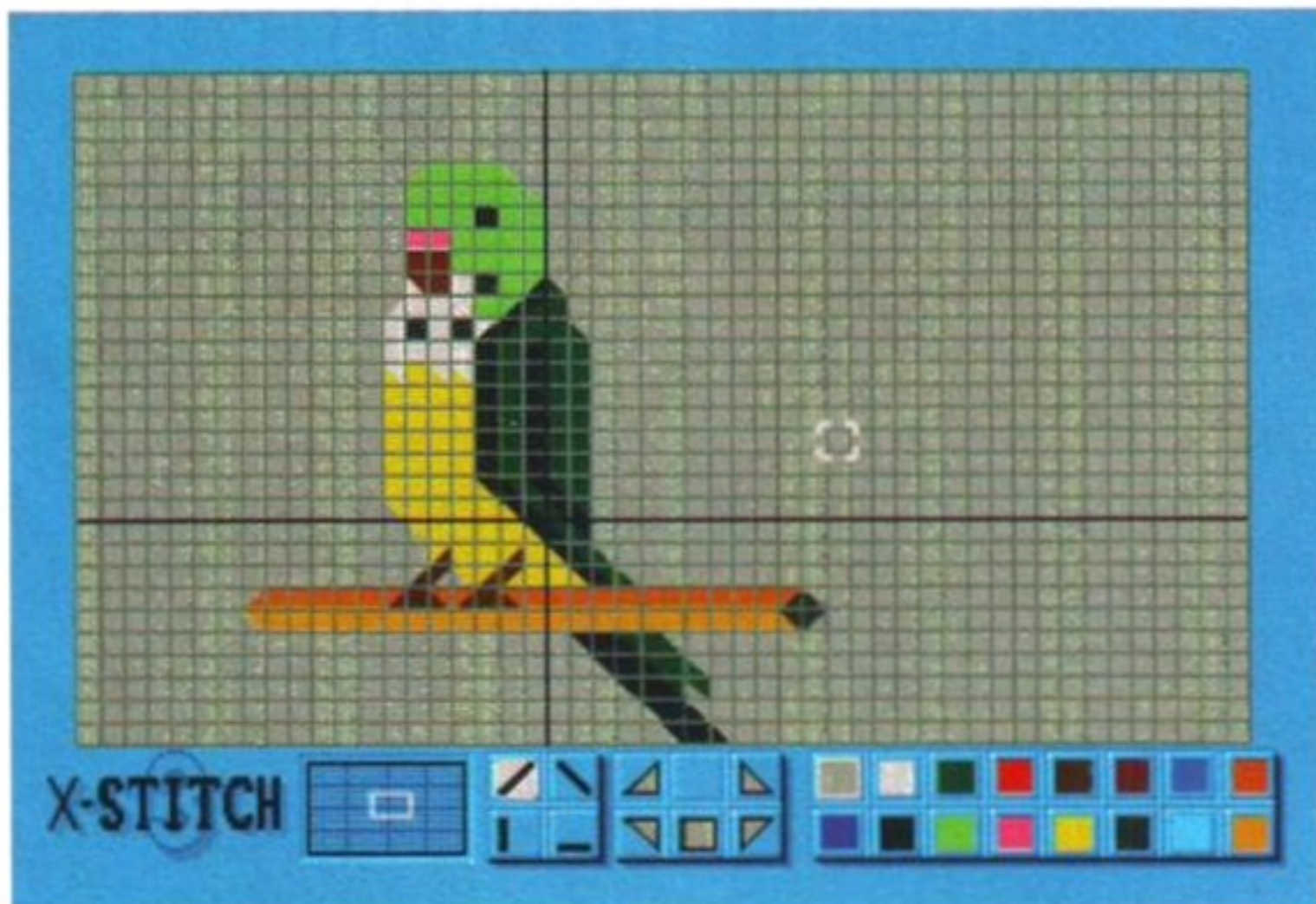

Straightforward and easy-to-use, X-Stitch Designer opens up a new and exciting world of possibilities for the needlecraft-mad Amiga owner. Is there one in your family?

YOU MAY OR may not have noticed, but in recent years people all over the country have been filling their leisure hours with an obsessive craft called cross stitch. You may have received a card, sampler or motto stitched by a friend or relation.

For those of you that don't know, cross-stitch works on the principle of building up a picture from lots of little squares, and as such is ideal for translation to a computer system. If an "x" shaped stitch is worked in the right colour to represent each of these squares that make the image you can reproduce a design in silks or cotton on linen or other fabric.

These fabrics are not printed with the design ready to be filled in, as is generally the case with embroidery, but instead a chart is provided leaving the stitcher to decide what sizes and colours to work with.

IL-Soft have made a "complete cross stitch charting software" package for the Amiga, and it could mean that grannies and mothers all over the country will soon be wrestling their offspring off the Amiga so that they can run this program.

You have a worksheet with a max size of 200 x 120 squares (this would produce a stitched piece of about thirteen inches by seven inches). You can only work on an area of 50 x 30 stitches at a time but the whole image can be reviewed. There is a palette of 16 colours which can be edited and named or numbered to correspond to a thread colour. You then select a stitch style - whole or

half stitches or backstitch - after which you can start to translate a rough idea into a finished workable design or, if you are feeling brave, straight on to the screen.

Depending on how complex the design is there are short cuts and handy functions you can use to easily speed up copying, filling, mirroring and enlarging.

The final stage is the printing, a symbol is chosen to represent each of your colours and the chart is printed out in blocks of 50 x 60.

For anyone in the crazed stage of cross-stitch mania who has an Amiga you can't go wrong for the price. ☺

X-STITCH DESIGNER V3

DESCRIPTION

Cross stitch pattern generator

MANUFACTURER

IL-Soft

DISTRIBUTOR

il-soft, 0993 779274

PRICE

£34.99

VERDICT

"An effective and useful program full of shortcuts and handy functions."

80%

LOOK HEAR!

FUTURE MUSIC

Future Music,
Britain's best-selling music
technology

magazine, now features a track-packed CD so you can:

HEAR the latest electronic musical instruments in all their glory

HEAR the cream of unsigned talent

HEAR how to get the most out of synths, samplers and digital effects

LOOK pretty damn smug as you enjoy more than 70 minutes of the finest sounds around

Plus all the regular news, reviews, interviews and how tos on making music with modern technology

FM 12, with covermounted CD, is on sale Tuesday 21 September - don't miss it!

Pop Will Eat Itself wouldn't want you to miss out on their exclusive interview in FM 12, so make sure you reserve a copy with your newsagent



Name.....

Address.....

Postcode..... Telephone.....

Dear Newsagent, please reserve me a copy of Future Music every month, starting with issue 12 on sale Tuesday 21 September.

FM is published on the third Tuesday of the month and is available fully paid from your local newsagent.

MAG*SAVE

GET YOURSELF CONNECTED

...or 'Win yourself one of three fabulous US Robotics Sportster modems courtesy of Phoenix Computer World'...



AFTER MONTHS OF whingeing about his crossflow transmutation V73Bis modulation being out of sync, we decided to buy Baguley a new modem. He insisted he needed a really fab one, and after much negotiation we decided we'd let him go out shopping with a budget of around £450 to get himself one.

Being the fastidious sort of a bloke he is (he used to own a PC, you know) Richard had a stringent set of parameters which defined his ideal modem.

First there was speed. He likes his modems fast, does our Dicky. And we like him to have fast modems too, because it cuts down on our (already excessively huge) telephone bill.



The Sportster modem may share a certain passing physical resemblance to a Stylophone, but it works a treat.

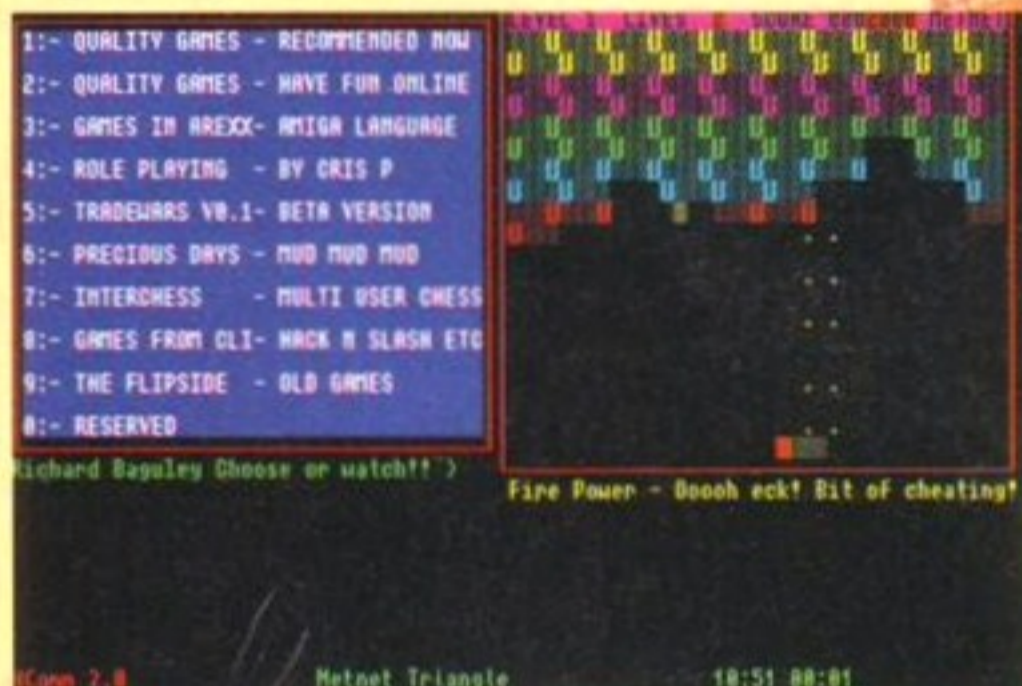

On-line games and other fun frolics and useful utilities are just a phone call away if you have your own modem.

Secondly there was reliability. There's nothing more frustrating than crashing in the middle of downloading pictures of a topless Claudia Schiffer from a bulletin board in Italy - only joking there, kiddies!

And finally there was BABT approval. Despite his network-wandering ways, Bilbo is very law-abiding. No hacking global megacorps for him, no downloading cracked software from pirate boards, nor does he hold tedious conversations with networked American divorcees pretending they are Brenda from 90210.

After much deliberation Richard made his decision, and he chose (roll of the drums)... the US Robotics Sportster.

It may be lovingly referred to in the office as 'the Stylophone', but the Sportster is a pretty spiff piece of kit. If you don't believe me, read the review on Page 145. Phoenix Computer World have given us three of the little (but powerful, fast and BABT approved) things to give away. ☺

HOW TO ENTER

Simply answer the questions below, write the answers on a postcard, or the back of a sealed envelope, and send them to us at:

I'm gonna get myself connected compo
Amiga Format
29 Monmouth Street
Bath
Avon
BA1 2DL

Obey these rules!

People who work for Future Publishing, US Robotics and Phoenix Computer World may not enter. And if you do we won't let you win.

All entries must arrive by Bonfire Night 1993.

Only entry per person. And if all your family are going to enter, at least get them to do it in their own handwriting.

No correspondence will be entered into, unless you actually are Brenda out of 90210.

- 1** What is the name of the mythical bird which allegedly rose from the ashes of fires?
- 2** What two engine sizes does the Harley Davidson Sportster come in?
- 3** Which famous bearded Australian singer, entertainer, artist (and all round genius) used to endorse the Stylophone?

AMIGA



PERIPHERALS

3 1/2" EXTERNAL FLOPPY DRIVE



ROCTEC ELECTRONICS LTD

Roctec Electronics are one of the world's leading Amiga peripheral manufacturers. Based in Hong Kong, they are responsible for many of the Amiga's best peripherals. Silica Systems are pleased to present a selected range of their products at new, low prices. Many of the Roctec peripherals shown below are award winning products and best sellers in their own specialised markets.

ROCGEN PLUS GENLOCK



SPECIAL OFFER
SAVE £99
ROCGEN PLUS + ROCKEY
SEE BELOW

FREE DELIVERY



Environmentally Friendly
BIO-DEGRADABLE PACKAGING

WORKS WITH ALL AMIGAS

SAVE £10 OFF RRP

RRP ~~£149~~

ROCGEN PLUS
£139
INC VAT Ref: VID 2000

Using the award winning RocLite 3 1/2" 880K external floppy disk drive with your Amiga will make a dramatic improvement to its performance. Running any serious applications or the latest games with a single drive, means constant swapping of disks and considerable waiting time. A second drive, improves software loading times and programs run more quickly not having to wait for disk insertions. The RocLite drive also includes superior features such as hardware virus protection for your software and prevention of the annoying 'clicking noise', present in most other drives, when no hard disk is inserted in the drive. Ultra slim, it is expertly designed and colour styled to match your Amiga, has an ultra low power consumption feature and is also daisy-chainable. The low Silica price of just £59, represents a saving of £10.95 off the normal RRP of £69.95 inc VAT.

- Built in anti-virus protection feature
- On/off/disable 'anti virus' mode
- Anti-click system built-in - prevents 'clicking noise' when no disk in drive
- Daisy chain allows additional drives to be attached
- Reliable Citizen drive mechanism
- Aluminium case
- Colour styled to match the Amiga
- Ultra low power consumption
- Slimline design - just 17.5mm high



"Highly Recommended"
Amiga Format 90% - June 93



Environmentally Friendly
BIO-DEGRADABLE PACKAGING

FREE DELIVERY

SAVE £10 OFF RRP

RRP ~~£69.95~~

ROCLITE
£59
INC VAT Ref: DRI 2969

Using RocGen Plus, you can enhance and add excitement to your video footage, bringing a whole new creative dimension to your video production. The RocGen Plus is a high performance genlock for use with all Amigas. It allows you to superimpose titles, graphics, clip art or animations onto your videos. Also included are such advanced effects as fade-in and fade-out, plus inversion of graphics, which allows the subject of your video to show through the overlay. A new keyhole effect also allows you to make all but the background colour transparent. Dual dissolve control knobs provide freely adjustable, varying degrees of overlay or invert effects and, independent RGB and video pass through allows you to display Amiga and video sources separately.

- Composite input/output
- LED status indicator
- Keyhole effect
- Hardware controls
- Compatible with RockKey for special video effects (see below)
- Bio-degradable packaging

- Auto RGB pass through function
- Three special effects modes:
Amiga Mode: Amiga Graphics only
Fade: Dissolve from Amiga to video in and vice versa
Overlay/Keyhole mode: Amiga graphics displayed as an overlay

SEE 'VIDEO SPECIAL EFFECTS' PANEL BELOW FOR SPECIAL OFFER

'PICTURE IN PICTURE' TV ADAPTOR



SAVE £10 OFF RRP

WORKS WITH ALL AMIGAS

Roctec PIP View allows you to watch one picture within another on your TV screen. This means you can have a game or application running on your Amiga and be watching a video or TV programme at the same time in a different area of the screen. Plus, it gives you a remote control facility for your TV.

- Picture in Picture TV adaptor
- 3 composite video inputs + one TV input
- Variable screen position for input display windows
- Adds remote control unit to your TV
- 99 programmable channels
- Digital tuner
- Headphone socket
- Includes power supply and remote control

FREE DELIVERY
RRP ~~£99.95~~
PIP VIEW
£89
INC VAT Ref: MOA 9010

ROCGEN GENLOCK



SAVE £10 OFF RRP

WORKS WITH ALL AMIGAS

The RocGen genlock allows you to enhance your video presentations by overlaying Amiga titles, graphics and animations onto your video source, eg. from a VCR or video camera. RocGen features three special effect modes: Amiga, overlay and fade. The special fade and dissolve knob, enables you to smoothly control the application of fade and overlay effects. RocGen is compatible with all Amigas and connects easily to the RGB port of your Amiga.

- Composite input/output
- Three special effects modes:
Amiga Mode: Amiga Graphics only.
Fade: Dissolve from Amiga to video in & vice versa.
Overlay: Amiga graphics displayed as an overlay
- Hardware fader control
- 1ft connection lead
- Optional power input (from Amiga or external source)
- LED status indicator
- Compatible with RockKey

"Good value for a budget genlock."
Amiga Format
ROCGEN
£69
INC VAT Ref: VID 1900

VIDEO SPECIAL EFFECTS



SAVE £70 OFF RRP

WORKS WITH ALL AMIGAS

RockKey is a keying device based on a colour splitter, that performs, amongst other special effects, Chroma Keying. This is almost the opposite of a genlock's function, allowing you to remove a particular colour from a video source and replace the 'keyed out' position with another video source or computer graphic. RockKey's sandwich function allows a video subject to be embedded in a graphic or vice versa. The built-in colour splitter controlled by Red, Green and Blue knobs, allows easy keying on any colour.

- Special effects: Chroma-key, Graphic Sandwich, Luma-key, Key Sandwich, Key Thru, Key Windows, plus many more
 - Comprehensive hardware controls
 - Compatible with most genlocks
- To use RockKey you will need a genlock. Silica are offering RockKey with the RocGen Plus genlock for only £249! A saving of £99 off the normal combined RRP of £348.95!

"...this sort of video power is unbelievable."
Amiga Format - Jan '93
ROCKEY + ROCGEN PLUS
£249
INC VAT Ref: VID 2020

EXTERNAL HD CASE



SAVE UP TO £100 OFF RRP

WORKS WITH ALL AMIGAS

RocMate is a stylishly designed external case and power supply unit for use with SCSI hard drive mechanisms. It requires a SCSI interface with a 25-way D-Type connector. A hard drive mechanism is simple to install and RocMate provides an ideal housing for your additional external hard drive mechanism.

- Includes power supply - works with Commodore A590, GVP HD8+, HC8+ and G-Force Accelerator
- Requires SCSI i/face + 25-way D-Type connector

FREE DELIVERY
RRP ~~£280~~
CASE WITH 42Mb HARD DRIVE
£199
INC VAT Ref: HAR 2010

ALL PRICES INCLUDE VAT - DELIVERY IS FREE OF CHARGE IN THE UK MAINLAND

090893-0900

SILICA SYSTEMS - THE AMIGA SPECIALISTS

Before you decide when to buy your Amiga peripheral, we suggest you think very carefully about WHERE you buy it. Consider what it will be like a few months after buying your peripheral, when you may require additional peripherals or software, or help and advice with your new purchase. And, will the company you buy from contact you with details of new products? At Silica Systems, we ensure that you will have nothing to worry about. We have been established for almost 14 years, we are Amiga specialists and are a Commodore approved dealer. With our unrivalled experience and expertise, we can now claim to meet our customers' requirements with an understanding which is second to none. But don't just take our word for it. Complete and return the coupon now for our latest FREE literature and begin to experience the "Silica Systems Service".

- **COMMODORE APPROVED UPGRADES:** Official Hard Drive upgrades with WANG on-site warranty.
- **FREE OVERNIGHT DELIVERY:** On all hardware orders shipped in the UK mainland.
- **TECHNICAL SUPPORT HELPLINE:** A team of Amiga technical experts will be at your service.
- **PRICE MATCH:** We normally match competitors on a "Same product - Same price" basis.
- **ESTABLISHED 14 YEARS:** We have a proven track record in professional computer sales.
- **£12 MILLION TURNOVER (with 60 staff):** We are solid, reliable and profitable.

- **BUSINESS + EDUCATION + GOVERNMENT:** Volume discounts are available. Tel: 081-308 0888.
- **SHOWROOMS:** We have demonstration and training facilities at all our stores.
- **THE FULL STOCK RANGE:** All of your Amiga requirements are available from one supplier.
- **FREE CATALOGUES:** Will be mailed to you, with special reduced price Amiga offers, as well as details on all Amiga software and peripherals.
- **PAYMENT:** We accept most major credit cards, cash, cheque or monthly terms (APR 29.8% - written quotes on request).

SILICA SYSTEMS

HOT LINE 081-309 1111

MAIL ORDER: 1-4 The Mews, Hatherley Rd, Sidcup, Kent, DA14 4DX Tel: 081-309 1111
Order Lines Open: Mon-Sat 9.00am-6.00pm No Late Night Opening Fax No: 081-308 0608

LONDON SHOP: 52 Tottenham Court Road, London, W1P 0BA Tel: 071-580 4000
Opening Hours: Mon-Sat 9.30am-6.00pm No Late Night Opening Fax No: 071-323 4737

LONDON SHOP: Selfridges (Basement Arena), Oxford Street, London, W1A 1AB Tel: 071-629 1234
Opening Hours: Mon-Sat 9.30am-7.00pm Late Night: Thursday - 8pm Extension: 3914

SIDCUP SHOP: 1-4 The Mews, Hatherley Rd, Sidcup, Kent, DA14 4DX Tel: 081-302 8811
Opening Hours: Mon-Sat 9.00am-5.30pm Late Night: Friday - 7pm Fax No: 081-309 0017

ESSEX SHOP: Keddies (2nd Floor), High Street, Southend-on-Sea, Essex, SS1 1LA Tel: 0702 468039
Opening Hours: Mon-Fri 9.30am-5.30pm (Sat 9.00am-6.00pm) Late Night: Thursday - 7pm Fax No: 0702 468039

To: Silica Systems, AMFOR-1193-115, 1-4 The Mews, Hatherley Rd, Sidcup, Kent, DA14 4DX

PLEASE SEND A 64 PAGE AMIGA COLOUR CATALOGUE

Mr/Mrs/Miss/Ms: Initials: Surname:

Company Name (if applicable):

Address:

Postcode:

Tel (Home): Tel (Work):

Which computer(s), if any, do you own?



THE CENTRE OF TEC



WTS ELECTRONICS LTD, CHAUL END LANE, LUTO

Amiga 1200 Packs



- 32-bit 68020 Full power
- On site warranty
- Two Python joysticks
- Free Paint package software
- Mouse mat

• A1200 Standalone	£274
• A1200 with 20 MB	£354
• A1200 with 40MB	£399
• A1200 with 60MB	£424
• A1200 with 80MB	£439
• A1200 with 120MB	£509
• A1200 with 200MB	£599

Amiga 4000 Packs



- AGA Chip set
- 68030/40 processor
- Co-pro option
- 2MB/4MB RAM
- A4000 030 with 80MB HD & 2MB **£899**
- A4000 030 with 80MB HD & 4MB **£999**
- A4000 030 with 120MB HD & 4MB **£1099**
- A4000 040 with 120MB HD & 6MB **£2139**

A500 Plus

- Amiga 500 Plus **£187**
- Cartoon Classic pack **£217**

A1200/A600 Hard Drives



- Easy to install upgrade kits
- Full instructions and cables where necessary
- All drives supplied with formatting instructions and software
- Free fitting available - phone for details
- 20MB HD Upgrade Kit **£85**
- 40MB HD Upgrade Kit **£135**
- 60MB HD Upgrade Kit **£154**
- 80MB HD Upgrade Kit **£169**
- 120MB HD Upgrade Kit **£249**
- 200MB HD Upgrade Kit **£329**

A1200/A600 Memory Upgrades

- A1200 PC 1204 4MB + clock (Co-pro option) **£198**
- ProRam 2MB PCM-CIA A600/A1200 **£118**
- ProRam 4MB PCM-CIA A600/A1200 **£127**
- ProRam 1MB A600 **£37**
- A1200 Real Time Clock **£17**

Amiga 500 Hard Drives



High Quality GVP Hard Drives

	A500	A1500
120MB	£389	£342
500MB	£889	£842
1GB	£1089	£1042

Internal Hard Drives for A500

- Easy to install - Full instructions
- ICD technology
- Pro Internal 20MB hard drive **£175**
- Pro Internal 40MB hard drive **£245**
- Pro Internal 80MB hard drive **£295**
- Pro Internal 120MB hard drive **£355**
- Pro Internal 200MB hard drive **£455**
- A570 CD drive **£149**

Monitors



- Philips 8833 MKII Monitor **£189**
- Commodore 1084s **£194**
- When purchasing with an Amiga deduct **£10** from above pricing
- Dust cover for the above **£5**

SVGA /Multisync Monitors



- 14"/20" Super high resolution colour display
- Professional IBM compatibility
- Complete with cable
- Full UK warranty
- Tilt & swivel stand
- A1200 SVGA Monitor (Displays high productivity modes) **£228**
- A1200 SVGA+ Monitor (Medium resolution, displays all modes high and low) **£274**
- A1200 SVGA+ Monitor (High resolution, displays all modes) **£369**
- A1200 SVGA plus 20" Monitor (Displays all modes ideal for DTP, CAD etc.) **£1044**

Workstations



- Ergonomically sound
- Facilitates up to three external floppy drives
- Made in the UK
- Strong and robust
- Aesthetically pleasing
- Keep your desk neat and tidy
- Supplied complete and assembled with free mouse mat
- A500 Workstation **£36**
- A600 Workstation **£36**
- A1200 Workstation **£36**
- Workstation Coverall dust covers **£5**

Peripherals



- 100 Capacity lockable disk box **£5.99**
- Squick mouse **£13.99**
- Mouse mat **£1.99**
- TDK high quality DSD (10) disks **£9.99**
- Computer Mall DSD (10) disks **£6**
- Jet Fighter joystick **£13.99**
- Apache joystick **£6.99**
- Python joystick **£9.99**
- Zipstick joystick **£14.99**
- Screen Beat speakers **£29**
- Zi-Fy speakers **£39**
- A500/A600/A1200 Dust covers **£4.99**
- A500 Modulator **£36**
- Mini Office package **£54.99**
- Supra 2400 Modem **£89**
- Supra Fax Plus Modem **£148**
- Supra v.32 BIS Fax Modem **£358**

Scanners



- Allows image processing in a useful and unique fashion
- Comes complete with operation manual
- One of the fastest growing applications for home and professional users
- High specification coupled with cost effective pricing
- **Power Hand Scanner**
- 64 greyscales 100-400 DPI
- Thru'port to printer
- Fully compatible with Delux Paint 4, etc.
- Advanced software
- Power Hand Scanner v3.0 **£96**
- Power Hand Scanner Colour **£229**

Pro ROM Swapper

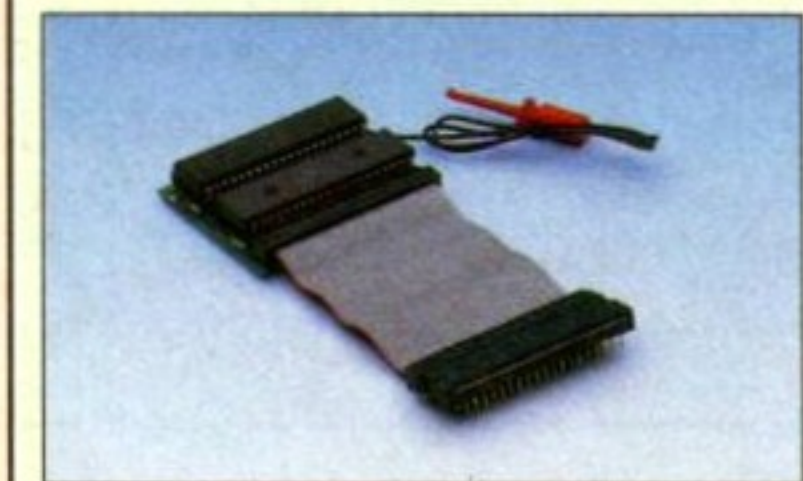

- Swap between Kickstart chips
- Fits A500, A500+, A600, A1500
- Auto swapping via keyboard control
- Flexible cable allows the swapper to work in conjunction with accelerators etc.
- Simple to fit - full instructions
- Pro ROM Swapper **£18**
- Pro ROM Swapper + 1.3ROM **£37**
- Pro ROM Swapper + 2.04ROM **£40**
- Workbench 2.04 plus manuals **£49**

TECHNICAL EXCELLENCE

Est. since
1984



N, BEDS, LU4 8EZ TEL (0582) 491949 (6 LINES)

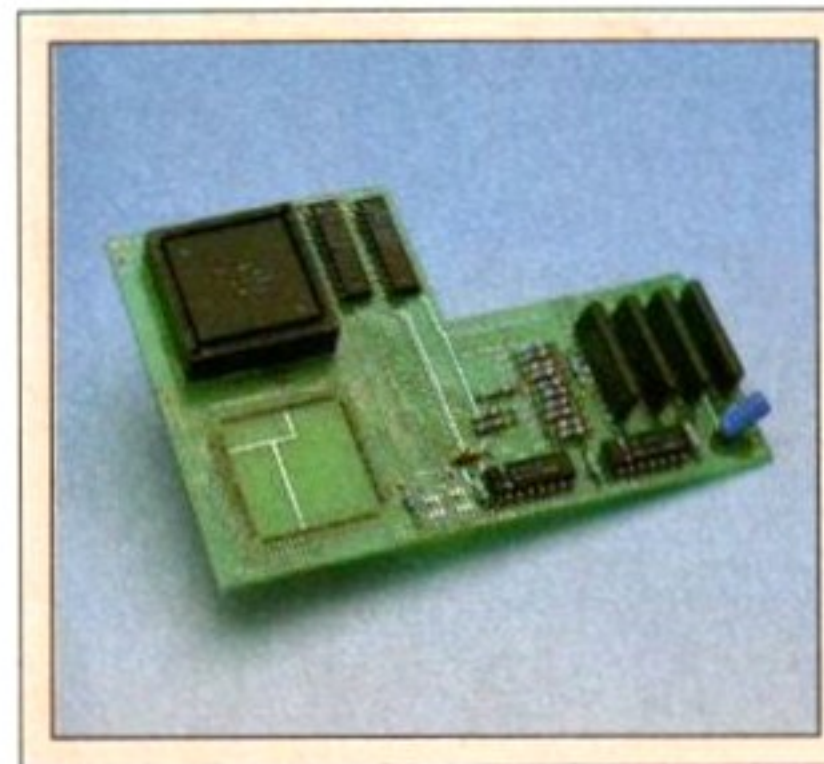

Pro Agnus 2MB

- Provides a full 2MB of Chip Memory for the Amiga 500 and A1500/2000
- Designed and built in England
- Supplied with 8375 Obese Agnus
- Includes 2Mb Memory on board in the form of low power Zips
- Allows the processing of elaborate animation and sound sampling
- Provides the same max. chipmemory as the A3000/A600 &500+
- Increases addressable memory space from 9MB to 10MB
- Complete with full instructions and flying leads
- British made

• Pro Agnus 2MB **£139**
(Free fitting available - Phone for details)

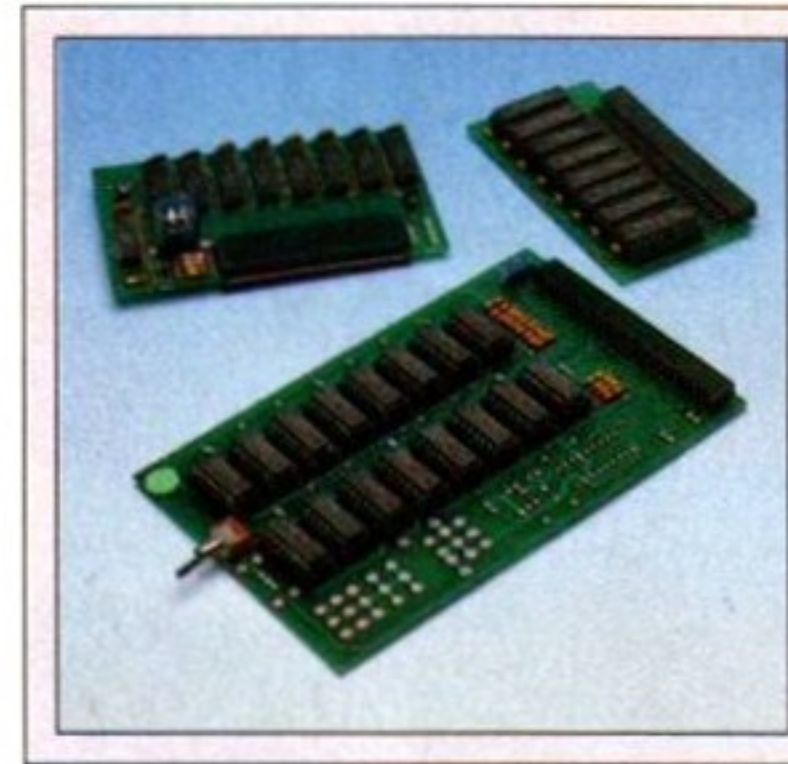

A500 Memory Expansions

A500 Pro-RAM 0.5 Meg. Upgrade

- Allows 1MB software to run
- Chip memory compatible
- British made

• Without clock **£16**
• With clock **£19**

A500 Pro-RAM 1.5 Meg Upgrade

- Gives a full 2MB of memory **£74**

A500+ 1MB Meg Upgrade **£29.95**

High Current Power Supply



- Allows the addition of peripherals without damage to computer or power supply
- Why risk damaging your expensive kit when one simple investment will ensure total peace of mind now and for the future
- Switch mode design
- Full crow bar projection
- British made

• A600 Power supply unit **£44.95**
• A500 Power supply unit **£44.95**
• A590 Power supply unit **£44.95**
• A1200 Power supply unit **£54.95**
• A2000 Power supply unit **£99.95**

Cumana 3.5" External Drive



- High Quality
- Renowned and proven reliability
- Top notch specification
- Anti-click
- Long moulded cable
- Slimline design
- High impact plastic

• Cumana external drive **£59**
• Cumana external drive + 100 capacity disk box **£62**
• Cumana external drive + 100 disk box + 20 blank disks **£68**
• A500/A500+ Internal replacement disk drive **£46**

Printers

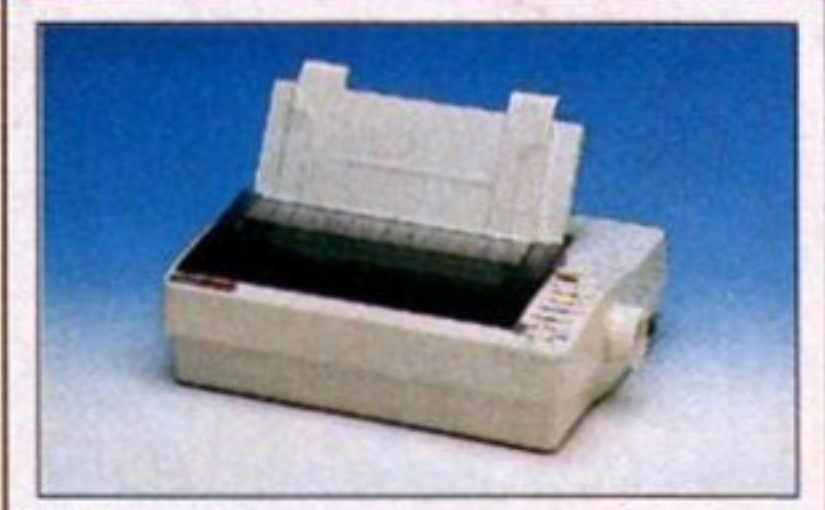

- High quality premium range of Amiga printers
- Two year manufacturers warranty.
- Complete with cable to Amiga 500
- Citizen registered for Dealer plus service

• Swift 1200+ **£129**
(9 pin, 80 column, 144 CPS draft, 30 NLQ, 4KDB Buffer)

• Swift 90 Colour **£168**
(9 pin, 80 column, 216 CPS draft, 54 LQ, 45dB quiet mode)

• Swift 200 **£186**
(24 pin, 80 column, 216 CPS draft, 72 LQ, 43dB quiet mode)

• Swift 240 Colour **£259**
(24 pin, 80 column, 240 CPS draft, 80 LQ, 43dB quiet mode)

• Swift Pro Jet **£299**
(80 column, 50 nozzle print, 360 CPS draft, 120 LQ, HP emulation 8KB buffer, 3 fonts, vertical lazer quality)

Chips and Spares



- WTS have sole distribution rights from Americas biggest Commodore chip distributor

• Workbench 2.04 Kit **£78**
(includes manuals, disks & chip)

• Kickstart 2.04 **£24**

• Kickstart 1.3 **£29**

• Kickstart ROM Swapper **£18**
(Swap between Kickstarts)

• Fatter Agnus 8372 **£29**

• Obese Agnus 8375 **£39**

• High Res Denise **£24**

• 1MB x 9 Simms (3 chip) **£29**

• 1MB x 4 Zips **£14**

• 8520 CIA **£9**

SALES HOTLINE 0582 491949 (6 LINES), 0480 471117 (24HR), FAX ON 0582 505900

Credit Card ordering by phone is easy. Simply phone our sales hotline quoting your credit card number., expiry date, name and address and the products you wish to order and we'll do the rest. Alternatively write the above details on your letter when ordering by post.

When ordering by post in cheque form please write your cheque card guarantee number on the reverse of the cheque and send along with your order. Postal Orders are also accepted.

NO DELIVERY CHARGES TO UK MAINLAND. MINIMUM ORDER AMOUNT £15.00.
Should you wish your order to be sent by courier service please add £5. This method includes Comprehensive insurance.

WARRANTY: One year return to base (excluding chips).
ONE YEAR EXTENDED WARRANTY: Available on all products (excluding chips) at 10% of purchase price when ordering.

WHERE TO FIND US!

Head Office
WTS Electronic Ltd
Chaul End Lane
Luton
0582 491949

Computer Mall Bedford
No.16 Downstairs
The Harpur Centre
Bedford
0234 218228

Computer Mall St. Neots
No.6
Priory Mall Shopping Centre
St. Neots
0480 471117

Computer Mall Hertford
49 Railway St.
Hertford
0992 503606

Computer Mall Dunstable
84 High Street North
Dunstable
Bedfordshire
0582 475747

All prices quoted or products stocked are subject to stocking levels and availability. WTS cannot be held liable or supply reimbursement for force majeure, or items, which are out of stock due to demand or low stock at its suppliers which may result in delayed delivery or non delivery, payment with order, please allow 28 days for delivery. WTS reserve the right to ammend prices, revise packs, specifications and or substitute product without prior notice at any time without liability upon itself. E & OE

HEE



PP!

What does all the jargon mean? Which software is best? How do I use Workbench? What does AmigaDOS do? Do I need to upgrade my Amiga? Which are the best games?...

We've got as many answers as you've got questions, and they're all in 'Get the Most out of your Amiga 1993'

- 300+ pages
- 90 reviews
- 50+ game tips
- 1.5Mb software
- AmigaDOS reference
- 200 margin notes
- 130 pics & diagrams



Get the Most out of your Amiga 1993 is the third edition of the best-selling Amiga title first published in 1991. The aim is simple: to produce the most authoritative, comprehensive and up-to-date guide possible to the Amiga, its uses and its software.

In other words, your Amiga's essential companion! The Amiga is the most powerful, versatile and cost-effective computer there is. Make sure you get the most out of YOURS.

The definitive Amiga reference • Just £19.95 including 2 disks!

Get the Most out of your Amiga 1993

Priority Order Form

Get the Most out of your Amiga 1993 will be available in the shops, but you can order a copy of this book right now, direct from our own Mail Order department. Postage and packing is FREE – you don't even need a stamp to send this order off!

Please send me: (tick as appropriate)

.....copy/copies of **Get the Most out of your Amiga 1993** at £19.95 each

Method of payment (please tick one):

VISA ACCESS CHEQUE P/O

CARD NUMBER

Expiry date:

Please tick here if you do not wish to receive direct mail from other companies:

Your name.....

Your address.....

Your signature.....

Now send this form to:

Future Leisure Books Offer
Future Publishing Ltd
Freepost
Somerton
Somerset TA11 7BR

For office use only:

ORDER CODE: FLB009A
SCRATCH CODE: AF52

US Robotics SPORTSTER MODEM

High speed and low price are the twin assets of this latest phone communications box. Richard Baguley gets in touch.

MODEMS ARE GETTING cheaper and faster by the month. A good case in point is this new model from US Robotics, which offers full V32Bis speed and Group III fax capability for only £249.99. It's also fully BAPT approved.

All of this is contained in a small cream box about seven inches wide, three inches deep and one-and-a-half inches high. The front of the box has a number of lights, which inform you of the state of the modem and it looks rather like a stylo- phone, although there's no sign of Rolf Harris's signature and no stylus.

At the rear of the case are four sockets for connecting the power, serial lead, telephone line and telephone. There is also a set of DIP switches which control the way the modem starts up.

You're told how to set the switches up in the manual, which is designed for use with different types of computers but is saved from being confusing by the fact that all the AT commands that you need to control the modem are detailed and plenty of examples are supplied.

The most important aspect of a modem such as this is how well it talks to others. Some modems have difficulty with certain others, but the Sportster has no such problems. I've used it to connect with bulletin boards as far apart as Hull and Arizona and it's not failed once. Even over dodgy transatlantic phone lines, it performs flawlessly.

It uses the V32bis protocol, which sends data at 14,400 bits per second. Add to this V42bis data compression and you are looking at a very fast modem. However, if you're talking to a modem that doesn't



ABOVE: The modem comes complete with a serial cable and a PD comms package.

RIGHT: The Sportster has built-in help on all of the commands which can be used with it.

```
HELP, Ampersand Commands (CTRL-S to S)
&An n=0 Disable /ARQ Result Codes
      n=1 Enable /ARQ Result Codes
      n=2 Enable /Modulation Codes
      n=3 Enable /Extra Result Codes
&Bn n=0 Floating DTE Speed
      n=1 Fixed DTE Speed
      n=2 DTE Speed Fixed When ARQ
&Cn n=0 CD Always On
      n=1 Modem Controls CD
&Dn n=0 Ignore DTR
      n=1 On-Line Command Mode
      n=2 DTE Controls DTR
&F Load Factory Configuration
&Hn n=0 Disable TX Flow Control
      n=1 CTS
      n=2 Xon/Xoff
```

BELOW: Using a fast modem such as the Sportster makes it much faster to access bulletin boards such as Metnet (pictured), which use a lot of ANSI graphics, and can save a lot of money when downloading big files.

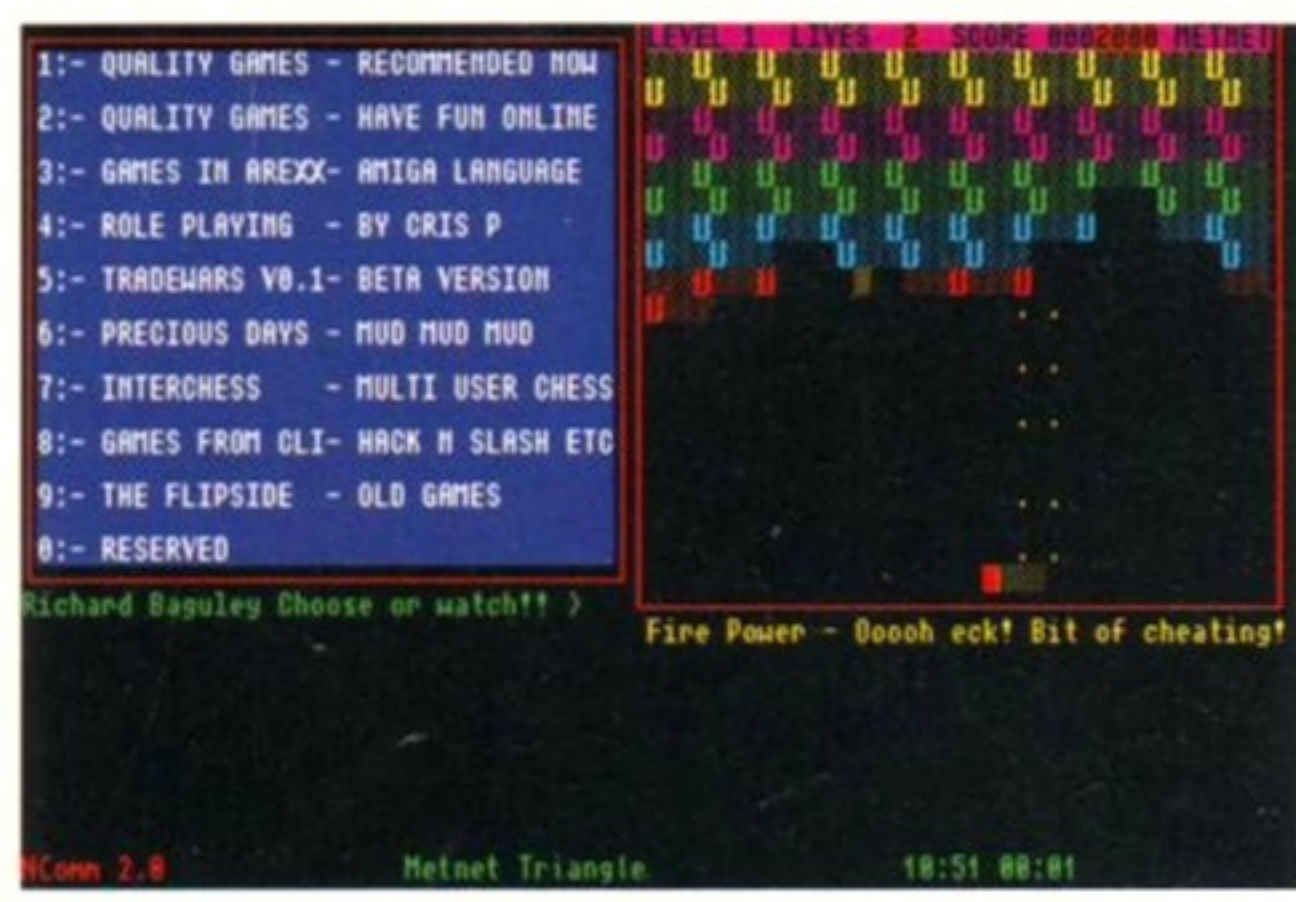

support V32bis it can also use a variety of slower protocols, including all of the ones that you're likely to come across, with the exception of HST, which is only found on more expensive modems.

Also supplied with the modem is the PD disk *Opticomm* (which includes the comms program *Ncomm*) and a serial lead to connect to the Amiga. This gives you all you need to get started in comms.

The Sportster can also handle faxes, but you will need some extra software to do this, such as the PD program *AFax* or the generic version of the commercial package *GPFax*. I wasn't able to test *GPFax*, but the demo version of *AFax* worked fine after a bit of tweaking of config files. The modem supports the common Group III fax standard, and can send and receive faxes at up to 9600 bits per second.

The obvious competitor to this new modem is the Supra V32Bis Fax modem, which is widely available for around £250. At this price, the Sportster is the clear winner, with full BAPT approval and none of the connection problems that have bedevilled the Supra since its release.

SPORTSTER MODEM

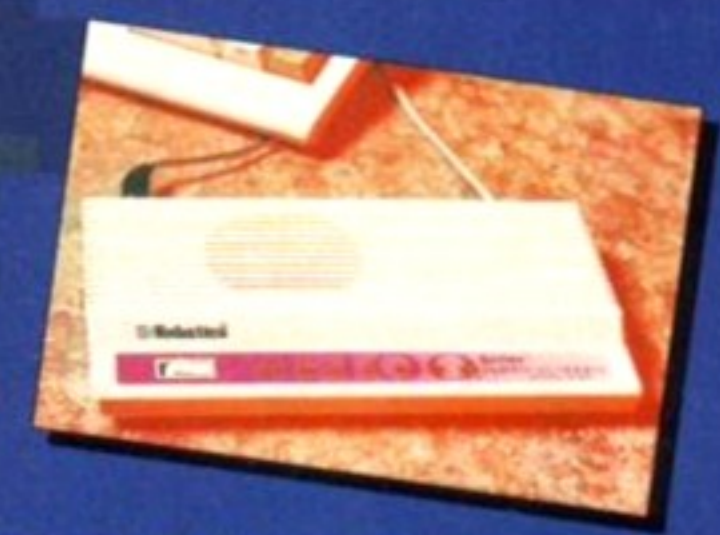

DESCRIPTION

V32bis modem with Group III fax

MANUFACTURER

US Robotics (0753 811180)

DISTRIBUTOR

Phoenix C World (0532 350091)

PRICE

£269.99

RELEASE

Already available

SPEED

V32bis is extremely fast, so you can download large files quickly. ●●●●

MANUAL

Fairly good, with plenty of explanation of the control commands. ●●●

ACCESSIBILITY

Bundled lead and software get you on-line immediately. ●●●●

FEATURES

With box fax and data capabilities, it's very well-featured. ●●●●

VALUE

Slightly more expensive than its Supra rival, but it is BT approved. ●●●●

VERDICT

“ An excellent modem, fast and at a reasonable price. Slightly more expensive than its nearest competitor, but this is the one to choose because it does what it promises. ”



Master your Amiga

Your Amiga's an extremely adaptable, powerful and versatile tool. Do you know what all the tools and utilities do? All the Workbench menu commands? What about AmigaDOS (the 'Shell')? It's all here, in a single wire-bound volume:

- Understanding the Workbench interface
- All the Workbench menu commands explained
- How to carry out routine tasks – renaming files, copying disks, formatting etc.
- Using the Workbench preferences tools to customise your Amiga
- Workbench tools, commodities and utilities – what they do and how to make them work for you
- **Plus** a complete AmigaDOS 2 & 3 command reference, including explanation, syntax and uses

160+ pages packed with essential Amiga info

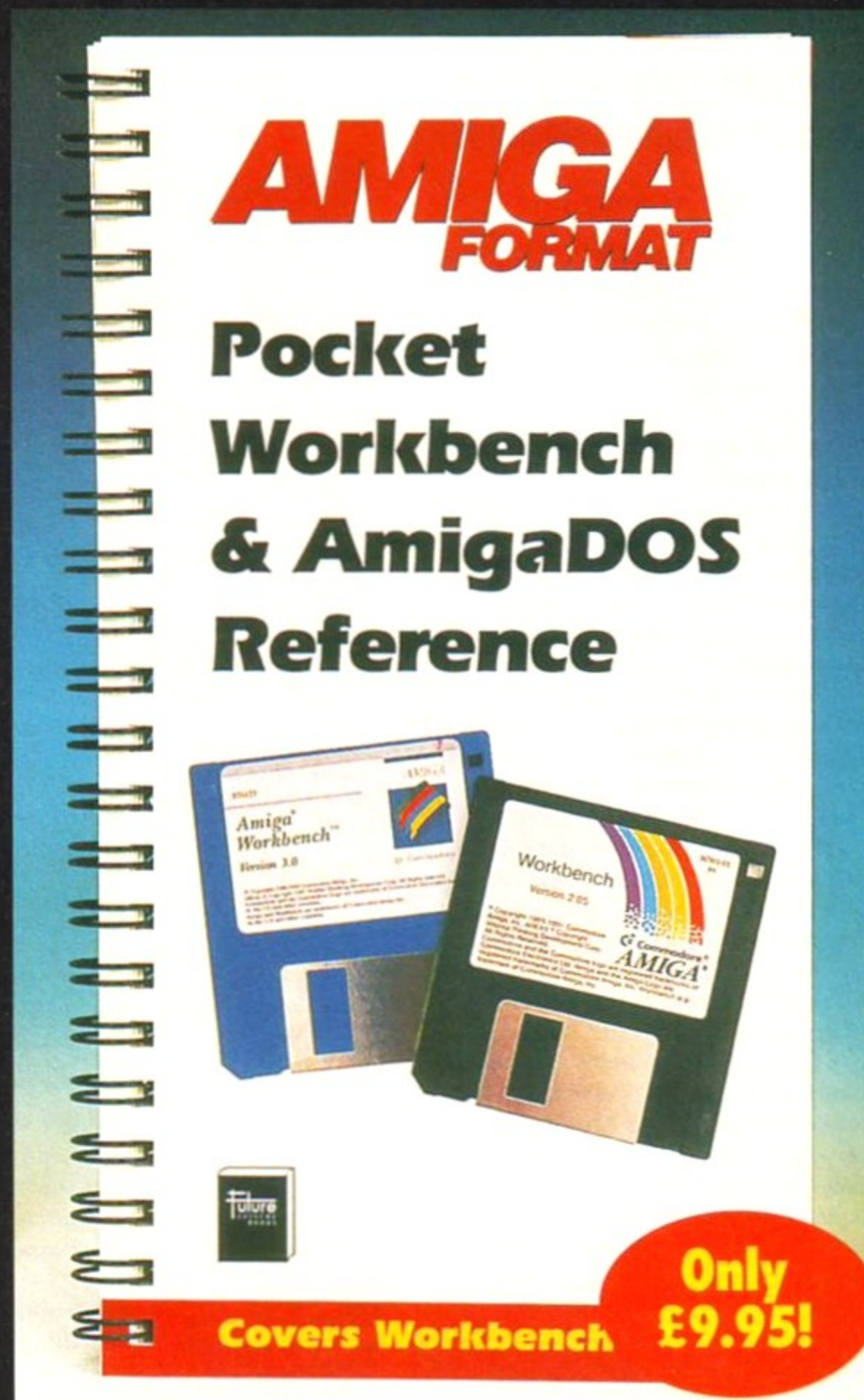

Pocket Workbench & AmigaDOS Reference

The Pocket Workbench & AmigaDOS Reference will be available in the shops, but you can order a copy of this book right now, direct from our own Mail Order department. Postage and packing is FREE – you don't even need a stamp to send this order off!

Please send me: (tick as appropriate)

.....copy/copies of **The Pocket Workbench & AmigaDOS Reference** at £9.95 each

Method of payment (please tick one):

VISA ACCESS CHEQUE P/O

CARD NUMBER

□□□□ □□□□ □□□□ □□□□

Expiry date: □□□□

Please tick here if you do not wish to receive direct mail from other companies:

Your name

Your address

.....

.....

Your signature

Now send this form to:

Future Leisure Books Offer
Future Publishing Ltd
Freepost
Somerton
Somerset TA11 7BR

For office use only:
ORDER CODE: FLB017A
SCRATCH CODE: AF52

Priority Order Form

AMIGA

NEW! AMIGA 1200 PACKS AMIGA CD³² CONSOLE

FROM SILICA SYSTEMS - THE UK'S No1 AMIGA SPECIALISTS

FREE! FROM SILICA

ZOOL SOFTWARE PACK



ZOOL is the software pack of the year. It includes: Zool, Transwrite, Pinball Dreams and Striker - Value £127.92.

All Amigas from Silica (excluding CD³², A600 Standalone and Amiga 4000) include a FREE ZOOL pack as well as GFA Basic and Photon Paint II.

ZOOL - Platform Title of the year - 97% Amiga Comp - Nov '92 £25.99
 TRANSWRITE - Word Processor and Spell Checker £49.95
 PINBALL DREAMS - Pinball Simulation - 94% AU - Sept '92 £25.99
 STRIKER - Soccer Simulation - 94% CU Amiga - June '92 £25.99

ZOOL PACK: £127.92

GFA BASIC v3.5 - Powerful Basic Programming Language ... £50.00
 PHOTON PAINT II - Powerful Graphics Painting Package ... £89.95

TOTAL VALUE: £267.87



WORTH OVER £265

AMIGA 500 PLUS CARTOON CLASSICS



SAVE £100!
 2Mb VERSION + £30 RAM UPGRADE
 INCLUDES BUILT-IN BATTERY BACKED CLOCK
 FREE! PHOTON PAINT II
 FREE! GFA + PHOTON PACK + GFA + PHOTON
 1 YEAR RETURN TO SILICA WARRANTY ON ALL CONFIGURATIONS
FREE DELIVERY
PACK INCLUDES:
 • 1Mb AMIGA 500PLUS £299.99
 • BUILT-IN 1Mb DRIVE
 • A520 TV MODULATOR
 • THE SIMPSONS £24.99
 • CAPTAIN PLANET £25.99
 • LEMMINGS £25.99
 • DELUXE PAINT III £79.99
 FREE FROM SILICA (See Top Left) £267.87
TOTAL PACK VALUE: £724.82
 LESS PACK SAVING: £525.82
SILICA PRICE: £199.00

1Mb RAM	SRP £299.99	£199	INC VAT - AMC 0592
2Mb RAM	SRP £329.99	£229	INC VAT - AMC 0592 + RAM 0525

AMIGA 600 STANDALONE



2Mb VERSION + £30 RAM UPGRADE
 FREE! PHOTON PAINT II
 FREE! GFA + PHOTON PACK + GFA + PHOTON
 1 YEAR ON SITE/AT HOME WARRANTY ON ALL CONFIGURATIONS
FREE DELIVERY
 We are pleased to offer the Amiga 600 with Photon Paint II, at a new low Silica price of only £199, a full £100 saving off the previous price.
PACK INCLUDES:
 • 1Mb AMIGA 600 £199.99
 • BUILT-IN 1Mb DRIVE
 • BUILT-IN TV MODULATOR
 • DELUXE PAINT III £79.99
 • LEMMINGS £25.99
 PLUS! FREE FROM SILICA:
 • PHOTON PAINT II £89.95
TOTAL PACK VALUE: £289.94
 LESS PACK SAVING: £90.94
SILICA PRICE: £199.00

1Mb RAM	PREVIOUSLY £299.99	£199	INC VAT - AMC 0625
2Mb RAM	PREVIOUSLY £329.99	£229	INC VAT - AMC 0625 + RAM 0525

AMIGA 600 LEMMINGS PACK



2Mb VERSION + £30 RAM UPGRADE
 FREE! PHOTON PAINT II
 FREE! GFA + PHOTON PACK + GFA + PHOTON
 1 YEAR ON SITE/AT HOME WARRANTY ON ALL CONFIGURATIONS
FREE DELIVERY
PACK INCLUDES:
 • 1Mb AMIGA 600 £199.99
 • BUILT-IN 1Mb DRIVE
 • BUILT-IN TV MODULATOR
 • DELUXE PAINT III £79.99
 • LEMMINGS £25.99
 FREE FROM SILICA (See Top Left) £267.87
TOTAL PACK VALUE: £573.84
 LESS PACK SAVING: £354.84
SILICA PRICE: £219.00

1Mb RAM	PREVIOUSLY £299.99	£219	INC VAT - AMC 0666
2Mb RAM	PREVIOUSLY £329.99	£249	INC VAT - AMC 0666 + RAM 0525

AMIGA 600 WILD, WEIRD & WICKED



2Mb VERSION + £30 RAM UPGRADE
 FREE! PHOTON PAINT II
 FREE! GFA + PHOTON PACK + GFA + PHOTON
 1 YEAR ON SITE/AT HOME WARRANTY ON ALL CONFIGURATIONS
FREE DELIVERY
PACK INCLUDES:
 • 1Mb AMIGA 600 £199.99
 • BUILT-IN 1Mb DRIVE & TV MODULATOR
 • DELUXE PAINT III £79.99
 • MICROPROSE GRAND PRIX £34.99
 • SILLY PUTTY £25.99
 • PUSH OVER £25.99
 FREE FROM SILICA (See Top Left) £267.87
TOTAL PACK VALUE: £634.82
 LESS PACK SAVING: £405.82
SILICA PRICE: £229.00

1Mb RAM	PREVIOUSLY £299.99	£229	INC VAT - AMC 0649
2Mb RAM	PREVIOUSLY £329.99	£259	INC VAT - AMC 0649 + RAM 0525

AMIGA 600 HD EPIC + HARD DRIVE



2Mb VERSION + £30 RAM UPGRADE
 FREE! PHOTON PAINT II
 FREE! GFA + PHOTON PACK + GFA + PHOTON
 1 YEAR ON SITE/AT HOME WARRANTY ON ALL CONFIGURATIONS
FREE DELIVERY
PACK INCLUDES:
 • 1Mb AMIGA 600 £199.99
 • BUILT-IN 1Mb DRIVE & TV MODULATOR
 • 20Mb HARD DISK £149.00
 • EPIC - A SCI-FI ADVENTURE £29.99
 • ROME - ROLE PLAYING ADVENTURE £25.99
 • MYTH - STOP THE SPREAD OF EVIL £19.99
 • TRIVIAL PURSUIT - POPULAR QUIZ £29.99
 FREE FROM SILICA (See Top Left) £267.87
TOTAL PACK VALUE: £722.82
 LESS PACK SAVING: £423.82
SILICA PRICE: £299.00

1Mb RAM	20Mb HD	£269	INC VAT - AMC 0708
1Mb RAM	64Mb HD	£349	INC VAT - AMC 0904
1Mb RAM	85Mb HD	£399	INC VAT - AMC 0985

AMIGA 1200 PACKS + HARD DRIVE OPTIONS



2Mb RAM RRP ~~£399~~ **£299** INC VAT - AMC 1224
2Mb RAM RRP ~~£349~~ **£349** INC VAT - AMC 1749

PACK INCLUDES:
 • 2Mb Amiga 1200
 • Nigel Mansell's World Championship AGA
 • Troits AGA
 • FREE! from Silica (See Top Left)

AMIGA 1200 SPECIFICATIONS
 • 68020EC Processor - 14.3MHz Clock Speed
 • 32-bit Architecture/2Mb Chip RAM
 • Amiga DOS v3.0/Built-in TV Modulator
 • AA Chip Set/16.8 Million Colours
 • 1 x 32-Bit CPU/RAM Expansion Slot
 • PCMCIA Smart Card Slot
 • 96 Key Keyboard with Numeric Keypad

HD OPTIONS	20Mb HARD DISK	64Mb HARD DISK	85Mb HARD DISK	127Mb HARD DISK	209Mb HARD DISK
RACE 'n' CHASE	£379	£449	£499	£529	£599
DESKTOP DYNAMITE	£429	£499	£549	£579	£649

AMIGA 1500 HOME ACCOUNTS



FREE! PC BRIDGE BOARD WORTH £100
SAVE £300!
 MONITOR OPTIONAL EXTRA
 FREE! PHOTON PAINT II
 FREE! GFA + PHOTON PACK + GFA + PHOTON
FULLY EXPANDABLE
 1 YEAR RETURN TO SILICA WARRANTY ON ALL CONFIGURATIONS
FREE DELIVERY
PACK INCLUDES:
 • 1Mb AMIGA 1500 £699.99
 • 2 x 3 1/2" BUILT-IN 1Mb FLOPPY DRIVES
 • EXPANSION SLOTS
 • PC COMPATIBILITY
 • VIDEO SLOT
 For enhanced graphics:
 • PC-XT BRIDGEBOARD SUPPLIED £100.00
 • PLATINUM WORKS SOFTWARE £169.95
 Word processor, database, spreadsheet
 • PUZZNIC £24.99
 • TOKI £24.99
 • ELF £24.99
 • HOME ACCOUNTS £29.99
 • DELUXE PAINT III £79.99
 FREE FROM SILICA (See Top Left) £267.87
TOTAL PACK VALUE: £1422.78
 LESS PACK SAVING: £1023.78
SILICA PRICE: £399.00

1Mb RAM	RRP £699.99	£399	INC VAT - AMB 1500
---------	------------------------	-------------	--------------------

AMIGA 4000 SPECIFICATIONS



1 YEAR ON SITE/AT HOME WARRANTY ON ALL CONFIGURATIONS
FREE DELIVERY



AMIGA 4000 CONFIGURATIONS

The Amiga 4000 '030' and '040' are available in several RAM/Hard Drive options from Silica Systems (please see below). All are fully configured and approved and carry Commodore's full one year on-site warranty. RAM upgrades are also available from Silica Systems. Due to current fluctuations in the market, please call for upgrade prices.
PLUS! FREE FROM SILICA
 • Photon Paint II
 • GFA Basic

25MHz 68030	2Mb RAM	80Mb HD	£979	INC VAT - AMB 3000
	4Mb RAM	120Mb HD	£1099	INC VAT - AMB 3100
	4Mb RAM	214Mb HD	£1199	INC VAT - AMB 3214
	4Mb RAM	340Mb HD	£1399	INC VAT - AMB 3340
	4Mb RAM	540Mb HD	£1699	INC VAT - AMB 3540
25MHz 68040	6Mb RAM	80Mb HD	£1949	INC VAT - AMB 4000
	6Mb RAM	120Mb HD	£2099	INC VAT - AMB 4100
	6Mb RAM	214Mb HD	£2199	INC VAT - AMB 4214
	6Mb RAM	340Mb HD	£2399	INC VAT - AMB 4340
	6Mb RAM	540Mb HD	£2699	INC VAT - AMB 4540

CDTV ADD-ON FOR A500 or A500PLUS



FREE DELIVERY
FREE SOFTWARE SEE BELOW
FREE FROM SILICA:
 • Lemmings - Award Winning Title RRP £34.99
 • Hutchinsons Encyclopedia CD RRP £29.99
 • Sim City - Classic Simulation RRP £29.99
 • CDPD - 600 Public Domain Titles RRP £19.99
WORTH NEARLY £115

• Enables your Amiga 500 to run CDTV software
 • Plays normal audio CD discs
 • Storage capacity equal to 600 floppy disks
 • Transfer time 153Kb/second
 • Compatible with CD + G and CD + MIDI formats
 • Compatible with ISO9660 standard
 • Some old A500s need modification - call for details
HALF PRICE CDTV RRP ~~£299~~ **£149** INC VAT - CCD 0570

AMIGA CD³² 32-BIT CD-ROM CONSOLE



NEW!
FREE DELIVERY

- 32-BIT POWER
The world's first CD-ROM console to use 32-bit technology, 4x faster than a 68000 CPU
- CD QUALITY STEREO SOUND
- 16.8 MILLION COLOUR PALETTE
- 256K MAX COLOURS ON-SCREEN
- GAMES FROM BELOW £20
- PLUGS INTO A TV OR MONITOR
- PLAYS MUSIC CDs
- DUAL SPEED
Transfers data almost twice as fast as ordinary CD-ROM drives
- MULTI-SESSION
Recognises ALL data on CDs, even if the information has been added after the initial pressing
- FULL SCREEN VIDEO-CD 11/93
Via an optional extra module which allows you to watch films on the CD32 - compatible with the latest Video-CD standard, endorsed by JVC, Matsushita, Philips and Sony
- 2Mb RAM
- 11 BUTTON CONTROL PAD
- 2 FREE CD TITLES
- OSCAR • DIGGERS
- COMPATIBLE WITH 26 CDTV TITLES

Amiga CD32 + 2 FREE CD TITLES **£299** INC VAT - CCD 3200

ALL PRICES INCLUDE VAT - DELIVERY IS FREE OF CHARGE IN THE UK MAINLAND

SILICA SYSTEMS - THE AMIGA SPECIALISTS

Before you decide when to buy your new Amiga computer, we suggest you think very carefully about WHERE you buy it. Consider what it will be like a few months after buying your Amiga, when you may require additional peripherals or software, or help and advice with your new purchase. And, will the company you buy from contact you with details of new products? At Silica Systems, we ensure that you will have nothing to worry about. We have been established for almost 14 years, we are Amiga specialists and are a Commodore approved dealer. With our unrivalled experience and expertise, we can now claim to meet our customers' requirements with an understanding which is second to none. But don't just take our word for it. Complete and return the coupon now for our latest FREE literature and begin to experience the "Silica Systems Service".

- **BUSINESS + EDUCATION + GOVERNMENT:** Volume discounts are available. Tel: 081-308 0888.
- **SHOWROOMS:** We have demonstration and training facilities at all our stores.
- **THE FULL STOCK RANGE:** All of your Amiga requirements are available from one supplier.
- **FREE CATALOGUES:** Will be mailed to you, with special reduced price Amiga offers, as well as details on all Amiga software and peripherals.
- **PAYMENT:** We accept most major credit cards, cash, cheque or monthly terms (APR 29.8% - written quotes on request).



HOT LINE 081-309 1111

MAIL ORDER: Order Lines Open: Mon-Sat 9.00am-6.00pm No Late Night Opening	1-4 The Mews, Hatherley Rd, Sidcup, Kent, DA14 4DX	Tel: 081-309 1111 Fax No: 081-309 0608
LONDON SHOP: Opening Hours: Mon-Sat 9.30am-6.00pm No Late Night Opening	52 Tottenham Court Road, London, W1P 0BA	Tel: 071-580 4000 Fax No: 071-323 4737
LONDON SHOP: Opening Hours: Mon-Sat 9.30am-7.00pm Late Night: Thursday - 8pm	Selfridges (Basement Area), Oxford Street, London, W1A 1AB	Tel: 071-629 1234 Extension: 3914
SIDCUP SHOP: Opening Hours: Mon-Sat 9.00am-5.30pm Late Night: Friday - 7pm	1-4 The Mews, Hatherley Rd, Sidcup, Kent, DA14 4DX	Tel: 081-302 8811 Fax No: 081-309 0017
ESSEX SHOP: Opening Hours: Mon-Fri 9.30am-5.30pm (Sat 9.00am-6.00pm) Late Night: Thursday - 7pm	Keddies (2nd Floor), High Street, Southend-on-Sea, Essex, SS1 1LA	Tel: 0702 468039 Fax No: 0702 468039

To: Silica Systems, AMFOR-1193-104, 1-4 The Mews, Hatherley Rd, Sidcup, Kent, DA14 4DX

PLEASE SEND A 64 PAGE AMIGA COLOUR CATALOGUE

Mr/Mrs/Miss/Ms: Initials: Surname:

Company Name (if applicable):

Address:

Postcode:

Tel (Home): Tel (Work):

Which computer(s), if any, do you own?

High quality products. Full technical support.

Visit our showrooms. See before you buy.

High quality products. Full technical support.

Visit our showrooms. See before you buy.

WeServe of Hampshire Established 8 years

Amiga Workstation /Expansion System
 Monitor stand with shelf for drives etc. Strong metal construction made from 14SWG steel epoxy coated. No Cables or mouse are included.
 Special price **£27.50**

All Citizen printers have a 2 year warranty
Swift 90 9pin Colour*
 Advanced 9pin printer, (Swift 9 replacement.) *optional colour. Price with cable & paper
 90 Mono **£145**
 90C Colour **£169**

Swift 240 24pin Colour*
With free PenPal
 240 Mono **£245**
 240C Colour **£265**

Swift 200 24pin Colour*
 Enhanced 24pin printer, (Swift 224 replacement.) *optional colour. Price with cable & paper
 200 Mono **£200**
 200C Colour **£224**

Citizen Projet Inkjet
 (Deskjet & Epson Compat) **£219**

Citizen 120D +
 with cable & paper **£115**

Dust Covers
 For Printers, Monitors, Computers most types in stock from **£4.70**

Citizen's Print Manager
 These advanced printer drivers transform colour printouts to laser type quality
 Version 1 (224 & 24E) **£5**
 Version 2 (Swift series 2) **£10**
 Drivers 1/2 price if bought with a printer
Printer Drivers
 Canon BJ-10e/ex **£5**
 Deskjet 500 Colour **£10**

Auto Sheet Feeders
 Canon BJ10 series **£52**
 Citizen Swift range **£79**
 Panasonic KXP range **£85**

Panasonic KXP1123
 Probably the best 24pin mono printer available. With cable & paper **£169**

Printers/Lasers
 KXP4410 Laser 5ppm **519**
 KXP1170 9pin **134**
 KXP1124i 24pin **215**
 KXP2180 9pin Colour **179**
 KXP2123 24pin Colour... **229**
 HP LaserJet 4L 4ppm ... **563**
 Epson EPL4000 6ppm ... **582**
 Epson LX400 9pin **119**
 Epson LQ570 + 24pin **265**
 Prices include VAT cable & paper

Mice *
 Golden Image Mouse **12.90**
 Genius Happy Mouse **12.90**
 True Mouse **12.90**

* **Deskjet 510**
 HP 300dpi Inkjet printer. Laser quality at dot matrix price. 3 year warranty. With cable & paper **£259**

* **Deskjet 500C**
 300dpi colour inkjet printer. Colour laser quality at 1/10 of the cost. 3 year warranty. With cable & paper **£299**

* **Deskjet 550C**
 300dpi colour inkjet printer. Colour laser quality, with colour and black cartridges resident. 3 year warranty. With cable & paper **£519**

Deskjet Portable
 * 3 year warranty. With cable & paper **£229**

Floppy Drives
Cumana CAX354
 1M external While stocks last **£52.90**

New **Roctec/Zappo**
 All Amigas A500-A1200 1M external drive **£52.90**

Printer Packs
 All printers are supplied with a printer pack consisting of printer paper and a connection cable. **Free of charge**
 A stand is £5.00 extra (with a printer)

Ink Refills
 BJ10 twin refill various colours **15.90**
 Deskjet twin refill various colours **15.90**
 (We stock 200 types of ribbons)

Canon BJ-10ex
 360dpi Inkjet printer with cable & paper **£199**

BJ-10sx **£219**
 360dpi Inkjet BJ10ex replacement

Canon BJ-200
 Inkjet + Sheet Feeder with cable & paper **£299**

Star LC100
 9pin colour with cable & paper **£149**

Star with cable & paper
 LC20 Mono 9pin **£123**
 LC200 Colour 9pin **£179**
 LC2420 Mono 24pin **£185**
 LC24100 Mono 24pin **£175**
 LC24200 Colour 24pin .. **£249**
 SJ48 360dpi Inkjet **£199**
 Auto Sheet Feeds from **£59**

Kickstart/Upgrades
 Commodore 2.04 full upgrade **79.00**
 Kickstart ROM only v2.04 **41.50**
 Kickstart ROM only v1.3 **29.00**
 Phoenix rom sharer **24.95**
 Keyb'd operated rom sharer **24.95**
 Fatter Angus custom chip **37.50**

360K drive **£29** *
 Enables A1500's etc to read IBM 5.25" 360K floppies

* = **Special Prices**
GVP Series 2

A500 Hard Disks *
 50Mb Hard Disk **£239**
 80Mb Hard Disk **£339**
 120Mb Hard Disk **£385**
 40Mb A530 Combo **£459**
 80Mb A530 Combo **£549**
 120Mb A530 Combo **£645**

A1500 Hard Disks
 40Mb Hard Disk **£275**
 80Mb Hard Disk **£319**
 120Mb Hard Disk **£395**
 Controller (no disk) **£129**
 GVP ram **£55 per 1Mb**
GVP PC Emulator £99
 286 16MHz Emulator for HD8+/A530

Amiga 500
Class of the 90's **£189**

Commodore Multiscan Monitors *
 1940 **£269** 14" Stereo Col. Dot pitch .39
 1942 **£369** 14" Stereo Col. Dot pitch .28

Ram Upgrades
 A500 0.5-1Mram + clock **£24.90**
 A500 0.5-1Mram no clock ... **£19.90**
 A500+ 1Mram + clock **£44.50**
 A600 CBM 1Mram no clock **£29.90**

Commodore 1084
 14" Stereo Colour Monitor. 0.42mm Pitch. Medium Res.
£179 with cable **£175** without cable
 1084ST with stand add **£10**

Philips CM8833 MK2
 14" Stereo Colour Mon. 240V UK. 0.42mm. Medium Resolution
£194 with cable **£190** without cable
 Add **£3** for Amiga / ST game

Accessories
 3M Joystick/Mouse lead **3.75**
 A500 Printer cable **7.95**
 Modulator/Disk Extension **10.95**
 23way Plug or socket **2.95**
 Computer Dust Cover **4.70**
 Type Through Covers **17.50**
 Mouse Mat (thick soft type) .. **4.95**
 Mouse House **2.95**
 1M internal 3.5" drive **49.00**
 A500 replacement PSU **39.00**
 A590 replacement PSU **49.00**
 Rocgen Plus - Genlock + .. **129.00**
 Disc Wallet for 32 disks **7.95**
 CBM A1011 Floppy drive **48.00**
 A3220 Display Enhancer **99.00**

Phone for our 70 page catalogue. All prices include 17.5% VAT EDUCATIONAL AND GOVERNMENT ORDERS WELCOME
 All products have a 30 day money back & 12 month warranty. Prices are subject to variation without prior notification. Please phone for express clearance of cheques. Credit APR 29.8% **Established 8 years.** 3 minutes from M27 Junction 11. Free parking. Open 9 to 5.30 Monday to Friday & 9 to 5 Saturday. Carriage/order. Postage 94p or £3.53 Securicor **£6.46** Securicor AM **£11.75**

WeServe
 Larger items delivered by Securicor

Amiga 500 +
Cartoon Classic Pack **£215**

Amiga 600SD
 (D.Paint III, Grand Prix, Putty, Pushover)
Wild Weird & Wicked **£179**
 with 1 free game **£169**

Amiga 600HD
 (20M Hd, Trivial P., Epic, Rome, Myth)
Epic Pack **£279**
 20M Hd NO Soft/W **£269**

Zool Pack add **£20**
 Comic Relief Pack add **£10**

A1200 **Now with 2 free games**
 5x faster. Workbench v3. 2M ram. Custom graphic 256K col. from 16.7M
 No Hd **£279**
 80M Hd **£495**
 120M Hd **£529**
Official Commodore approved Hard Disk with CBM on-site.

Amiga A4000
 4000/030 2M 80Mb Hd **£895**
 4000/030 2M 120Mb Hd **£975**
 4000/030 6M 80Mb Hd **£1049**
 4000/030 6M 120Mb Hd **£1139**
 4000/040 6M 120Mb Hd **£1919**

* **Amiga 1500 +** while stocks last **£279**
 * **Opal Vision** while stocks last **£499**

SONY DISKETTES
SONY branded (lifetime warranty)
 (100% certified error free)
 10x 3.5" DS/DD 135tpi **7.50**
 50x 3.5" DS/DD 135tpi **32.30**
 100x3.5" DS/DD 135tpi **59.93**
 250x3.5" DS/DD 135tpi **141.00**
 1kx 3.5" DS/DD 135tpi **540.50**

DISKETTES SONY / DYSAN bulk (lifetime warranty)
 (100% certified error free)
 10x 3.5" DS/DD 135tpi **5.95**
 50x 3.5" DS/DD 135tpi **21.86**
 100x3.5" DS/DD 135tpi **39.60**
 250x3.5" DS/DD 135tpi **94.88**
 1kx 3.5" DS/DD 135tpi **379.53**
 40 x 3.5" Disk box with lock..... **5.49**
 100 x 3.5" Disk box with lock.... **7.50**
 Carriage on 50+ disks **£3.53**

Amiga/Format Dept.
40-42 West Street
Portchester Hants
PO16 9UW
Tel: 0705 647000

Software Failure. Press left mouse button to continue.
Guru Meditation #81000005.00252E7C

Meditate on this

The latest *Amiga Shopper* has 26 pages jam-packed with answers to common and not so common Amiga problems.

Our expert panel covers every conceivable field, from AmigaDOS to video. And our cover disk, as well as being crammed with source code, a spreadsheet and a database, contains a suite of Commodore's debugging utilities to help you solve your coding conundrums. It's on sale Tuesday 5 October for £2.95. Don't get stuck, get...

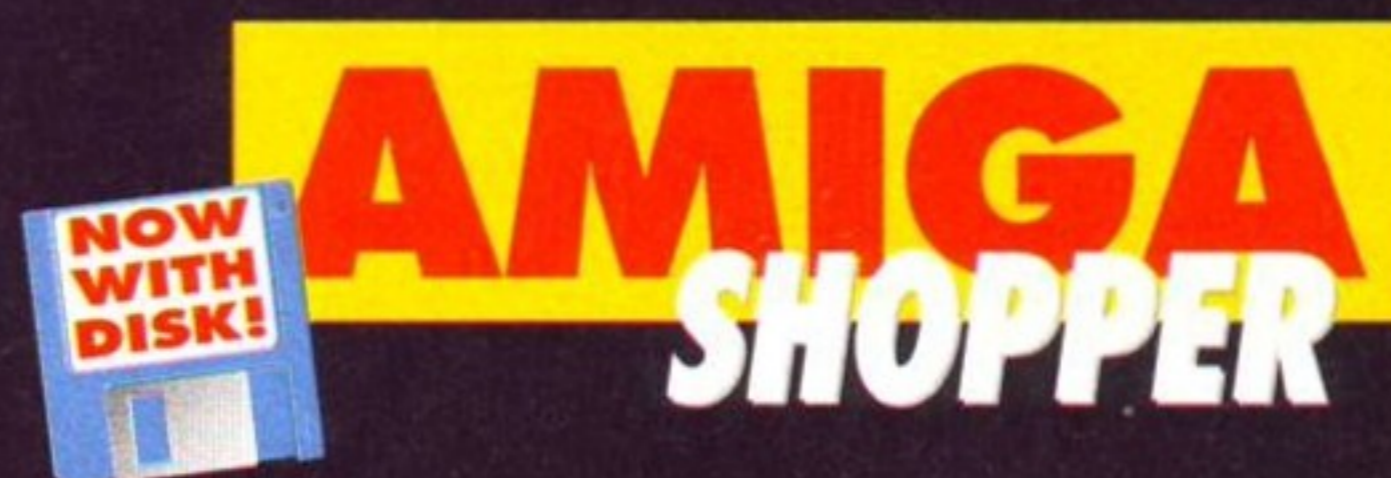

Eagle Software



CREDIT CARD HOTLINE:

081 889 9172

ENQUIRY/ORDER LINE:

081 361 5730

24 HOUR FAX LINE

081 361 2733

118a Palmers Road
New Southgate
LONDON N11 1SL

BITMAP BROTHERS VOL 1 only £16.99 Xenon, Cadaver and Speedball II	DREAM TEAM only £16.99 Terminator II, Simpsons, W.W.F.	RAVING MAD only £12.99 Mega Twins, Rodland, Robocod
SPACE LEGENDS only £18.99 Aaiga only Megatraveller I, E.Ra, Wing Commander	SOCCER MANIA only £11.99 Football Manager II, Gazza's Soccer, Football Manager - W.C. Edition, Microprose Soccer	COMBAT CLASSICS II only £20.99 F19 Stealth Fighter, Silent Service II and Pacific Islands
BIG BOX only £15.99 Captain Blood, Tin Tin on the Moon, Safari Guns, Teenage Queen, Bubble Plus, Purple Saturn Days, Krypton Egg, Jumping Jackson, BoBo, Hostages	TEST DRIVE II COLLECTION only £15.99 Muscle Cars, California Challenge, European Challenge, Duel, Super Cars	BIG BOX II only £19.99 Back to the Future III, R-Type, IK+, Real Ghostbusters, Def of the Earth, TV Sports Football, Shanghai, Analyle, Sinbad, Bombzoal
BOARD GENIUS only £17.99 Deluxe Monopoly, Deluxe Scrabble Cleudo Master Detective and Risk	4 WHEEL DRIVE only £19.99 Lotus Esprit, Celica GT4 Rally, Team Suzuki, and Combo Racer	POWER PACK only £14.99 Xenon 2, TV Sports Football, Bloodwych and Lombard Rally
HOLLYWOOD COLLECTION only £18.99 RoboCop, Ghostbusters 2, Indiana Jones, Batman the Movie	RAINBOW COLLECTION only £13.99 New Zealand Story, Bubble Bobble, Rainbow Islands	COMBAT CLASSICS only £20.99 F15 Strike Eagle II, 688 Attack Sub and Team Yankee
TRIPLE PACK 1 (SPORTS) only £12.99 Microprose Soccer, Panza Kick Boxing, 3D Pool	NINJA COLLECTION only £13.99 D. Dragon, Shadow Warrior, D. Ninja	TRIPLE PACK II (ACTION) only £12.99 Streetfighter, Rick Dangerous II, Last Crusade Action
THE GREATEST only £19.99 Jimmy White's Whirlwind Snooker, Lure of the Teampress, and Dune	AWARD WINNERS ONLY £16.99 Kick Off II, Pipemania, Space Ace and Populous	2 HOT 2 HANDLE only £12.99 Golden Axe, Total Recall, Shadow Warrior, Super Off Road Racing
STRATEGY MASTER only £21.99 Deuteros, Populous, Hunter, Chessplayer 2150 and Spirits of Excalibur	SUPER FIGHTER only £16.99 P.Fighter, W.W.F., Final Fight	MEGA MIX only £12.99 Leander, Agony and Ork
DIZZYS EXCELLENT ADVENTURES only £16.99 Dizzy Panic, Bubble Dizzy, Dizzy Prince of York Folk, Spellbound Dizzy and Kwik Snake	NAPOLEONICS only £16.99 Waterloo, Borodino, Austerlitz	SPORTS COLLECTION only £12.99 Run the Gauntlet, Pro Tennis Tour and World Cup Soccer (Italia '90)
SPORTS MASTERS only £19.99 PGA Tour Golf, Indy 500, Advantage Tennis, and European Championship 1992	ANIMATION CLASSICS only £27.99 Space Ace, Dragon's Lair II, Wrath of the Deemon	ACTION 5 only £19.99 Rick Dangerous II, Ghostbusters II, Gunship, Super Ski and Hard Driving

TOP TITLES	AMIGA	TOP TITLES	AMIGA	TOP TITLES	AMIGA	TOP TITLES	AMIGA	EDUCATIONAL	
1889	£19.99	Cohort II	£19.99	Kings Quest VI* (A1200)	£37.99	Scrabble (US Gold)	£18.99	ADI English 11-12	£16.99
A500+ 1Meg Upgrade	£39.99	Combat Air Patrol	£18.99	Knight Mare	£11.99	Second Samurai	£17.99	ADI English 12-13	£16.99
A600 1Meg Upgrade + clock	£49.99	Cover Girl Poker	£12.99	Knights of the Sky	£12.99	Secret Silver Blades	£16.99	ADI English 13-14	£16.99
0.5 Meg Upgrade + clock	£25.99	Crazy Cars III	£9.99	Lamborghini USA Challenge	£16.99	Sensible Soccer 92-93	£16.99	ADI French 11-12	£16.99
3D Construction Kit II	£36.99	Crystal Kingdom Dizzy	£13.99	Lawn Mower Man*	£16.99	SHADOW BEAST II	£11.99	ADI French 12-13	£16.99
A320 Airbus	£23.99	Cyberspace*	£23.99	Leander	£10.99	Shadow of the Beast III	£11.99	ADI French 13-14	£16.99
A320 Airbus USA	£23.99	Dalek Attack	£12.99	Leeds Utd	£16.99	Shadow Worlds	£16.99	ADI Maths 11-12	£16.99
A-Train	£23.99	Darkmere	£18.99	Legacy*	£23.99	Silent Service II	£23.99	ADI Maths 12-13	£16.99
A-Train Con Set	£13.99	Das Boot	£11.99	Legend	£11.99	Sim Ant	£22.99	ADI Maths 13-14	£16.99
Addams Family	£7.99	D-Day	£16.99	Legend II (Worlds of Legend)	£16.99	Sim Earth	£16.99	Better Spelling 8-14	£14.99
Airbucks 1.2 (5/6/1200)	£19.99	Deluxe Music Con Set	£74.99	Legend of Kyrandia	£19.99	Sim Life A1200/500	£19.99	Better Maths 12-16	£14.99
Air Combat Patrol	£19.99	Deep Core*	£16.99	Lemmings	£15.99	Sleepwalker 500/1200	£14.99	Fun School 2 under 6	£6.99
Air Force Commander	£19.99	Desert Strike	£19.99	Lemmings and Data Disk	£19.99	Snow Bros	£19.99	Fun School 2 6-8	£6.99
Air Support	£11.99	Desert Strike II*(Jungle Str)	£20.99	Lemmings II	£19.99	Soccer Kid 500/1200	£19.99	Fun School 2 over 8	£6.99
Alfred Chicken	£16.99	Detroit	£18.99	Lemmings - Data Disk	£10.99	Soup Trek*	£16.99	Fun School 3 under 5	£13.99
Alien Breed 2	£17.99	D/Generation	£11.99	Lemmings - Stand Alone	£15.99	Space 1889	£16.99	Fun School 3 5-7	£13.99
Aliens III*	£16.99	Diggers (CD)*	£23.99	Links	£12.99	Space Gun	£12.99	Fun School 3 7+	£17.99
A. Maclean's Pool	£16.99	Disney Animation Studio	£74.99	Liquid Kids*	£16.99	Space Hulk*	£23.99	Fun School 4 under 5	£16.99
American Gladiators	£15.99	Dogfight	£23.99	Loom	£10.99	Space Crusade + Upgrade	£16.99	Fun School 4 5-7	£16.99
Amos (Easy)	£23.99	Dreadnoughts	£22.99	Lost Vikings	£16.99	Space Quest IV	£23.99	Fun School 4 7+	£16.99
Amos 3D	£23.99	Dream Web*	£27.99	Lost Treasures of Infocom	£23.99	Special Forces	£23.99	Junior Typist	£11.99
Amos Compiler	£19.99	Dune	£19.99	Lotus Turbo Challenge III	£16.99	Starflight II	£10.99	Magic Maths (4-8)	£14.99
Amos Professional	£54.99	Dune II	£19.99	M1 Tank Platoon	£11.99	Star Trek 25th Anniversary*	£19.99	Maths Mania	£14.99
Amos Professional Compiler	£23.99	Dungeon / Chaos	£19.99	MacDonald Land	£9.99	Steel Empire	£20.99	Noddy's Playtime	£16.99
Amos The Creator	£36.99	Elvira II - Cerberus	£23.99	Maelstrom (1 meg)	£23.99	Stereo Master	£26.99	The Three Bears	£14.99
Apocalypse	£19.99	Epic	£19.99	Magic Boy*	£16.99	Street Fighter II	£17.99		
Arabian Nights 500/1200	£19.99	European Champions	£16.99	Magic Pockets	£15.99	Striker	£16.99		
Armourgeddon	£15.99	Eye of the Beholder	£19.99	Man Utd Premier*	£19.99	Super Cauldron	£16.99		
Armourgeddon II*	£19.99	Eye of the Beholder II	£23.99	Mario is Missing	£16.99	Superfrog	£16.99		
Assassin	£16.99	F15 Strike Eagle II	£12.99	Mean Avenas*	£16.99	Super Mario Brothers	£18.99		
A.T.A.C.*	£23.99	F117A Stealth Fighter	£23.99	Micro Machines	£16.99	Super Space Invaders	£7.99		
B17 Flying Fortress	£23.99	F19 Stealth Fighter	£12.99	Microprose Golf	£7.99	Super SWIV*	£16.99		
Bane of the Cosmic Forge	£24.99	F29 Retaliator	£7.99	Midwinter II	£12.99	Syndicate	£23.99		
BARBARIAN II (Psyg)	£10.99	Falcon	£11.99	Might of Magic III	£23.99	Syndicate Data Disc*	£14.99		
Bart vs the World*	£16.99	Falcon Mission Disk I	£8.99	Moanstone	£10.99	Test Drive III*	£15.99		
Batman Returns*	£16.99	Falcon Mission Disk II	£8.99	Monkey Island	£15.99	TFX *A1200	£23.99		
Battle Chess II	£16.99	Fate of Atlantis (Adv)	£25.99	Monkey Island II	£25.99	Theatre of Death*	£18.99		
Battle Isle '93	£20.99	Fate of Atlantis (Arc)	£16.99	Mouse (Switchable)	£9.99				
Battle Toads	£16.99	Final Fight	£7.99	Morph	£15.99				
Beavers	£16.99	Fire and Ice	£15.99	Myth	£8.99				
Beneath the Steel Sky	£19.99	FireStone HD Scenery	£13.99	Nick Faldo Golf	£23.99				
Birds of Prey	£9.99	Fleshback	£20.99	Nicky Boom II	£16.99				
Black Crypt	£16.99	Football Manager III*	£15.99	N. Mansell World Champ	£20.99				
Blade of Destiny	£30.99	Free DC	£18.99	Noddy's Big Adventure	£16.99				
Blastar	£16.99	Global Effect	£16.99	One Step Beyond	£13.99				
Blob	£16.99	Global Gladiators	£19.99	Overlanders*	£16.99				
Blue Max	£11.99	Goal/Kick Off III	£19.99	Overdrive	£17.99				
Body Blows	£16.99	Goblins II	£19.99	Pacific Islands - T.Yankee II	£20.99				
Brutal Sports Football*	£16.99	Gods	£14.99	Pacific Islands II*	£21.99				
Bubble N'Str	£16.99	G. Gooch Cricket	£19.99	Parasol Stars	£15.99				
Buck Rogers	£19.99	Graham Taylor	£15.99	Patrician	£17.99				
Buck Rogers II*	£20.99	Grand Prix (Formula)	£23.99	PGA Golf Tour +	£20.99				
Bully's Sporting Darts	£7.99	Gunship 2000	£23.99	PGA Courses Disk	£10.99				
Burning Rubber	£16.99	Harlequin	£14.99	Pinball Dreams	£15.99				
Burn Up	£16.99	Harpoon (1 Meg)	£19.99	Pinball Dreams II	£16.99				
Cadaver - the pay off	£10.99	Harrier Assault AV8B	£23.99	Populous II - The Challenge	£11.99				
Caesar	£16.99	Hero's Quest II	£16.99	Populous II + (1 Meg)	£23.99				
Caesar deluxe	£19.99	Hill Street Blues	£7.99	Power and Glory	£19.99				
Campaign	£22.99	Hired Guns	£23.99	Power Up Compilation	£12.99				
Campaign Mission Disk	£10.99	Historyline 1914-18	£21.99	Premier Manager	£16.99				
Campaign II*	£23.99	Hook	£10.99	Push Over	£8.99				
Captive	£11.99	International Open Golf	£16.99	Putty	£12.99				
Captive II	£17.99	International Sports Chall.	£15.99	Railroad Tycoon	£23.99				
Car and Driver*	£23.99	Ishar II 500/1200	£19.99	Reach for the Skies	£19.99				
Carl Lewis Challenge	£12.99	Jaguar XJ220	£16.99	Red Baron	£15.99				
Castles	£16.99	James Pond III (Op Starfish)	£16.99	Road Rash	£16.99				
Castles Data Disc	£11.99	J. White's Whirlwind	£16.99	Robin Hood (Millenium)	£9.99				
Castles II*	£23.99	J. Barnes (1 Meg)	£15.99	Robocod	£15.99				
Castle of Dr Brain	£15.99	J. Madden's Football	£16.99	Robocod A1200	£16.99				
Chaos Engine	£16.99	Jurassic Park*	£18.99	Robocod III	£8.99				
Championship Manager '93	£16.99	KGB	£16.99	Robo Sports	£16.99				
Chase HQ II	£8.99	Kick Off II (1 Meg)	£15.99	Rookies*	£17.99				
Chuck Rock II	£10.99	Kick Off II (5 Meg)	£14.99	Ryder Cup	£16.99				
Civilisation	£23.99	Killing Game Show	£11.99	Sabre Team	£16.99				
Civilisation A1200	£27.99	Kingdom of Germany*	£19.99	Sabre Team 1200	£19.99				
C.Y.'s Air Combat	£20.99	Kingmaker	£19.99						

3.5 DS DD discs
with Labels boxed in 10's

10x 3.5 DS DD	£5.99
20x 3.5 DS DD	£11.99
30x 3.5 DS DD	£15.99
50x 3.5 DS DD	£21.99
100x 3.5 DS DD	£39.99

Please add 50p per 10 discs when ordering to cover P & P

Wing Commander £12.99

Wiz Kid	£15.99
Woody's World	£16.99
W.W.F.	£7.99
W.W.F. II	£8.99
Yol Joel	£16.99
Zool 500/1200	£16.99

AMIGA BUDGET TITLES UNDER £10

688 Attack Sub	£9.99	Head over Heels	£6.99
Afterburner	£8.99	Hudson Hawk	£8.99
Altered Beast	£6.99	IK+	£6.99
Arkanoid II	£6.99	Indy Last Crusade Graphic	£9.99
ATOMINO	£8.99	James Pond	£6.99
Barbarian	£5.99	Jet Set Willy	£7.99
Barbarian II	£6.99	J. Khan Squash	£8.99
Batman The Movie	£6.99	Last Ninja II	£7.99
Battlehawks 1942	£9.99	Last Ninja III	£7.99
Blood Money	£6.99	Lombard RAC Rally	£6.99
Blues Brothers	£9.99	Lotus Esprit	£6.99
Cabal	£6.99	Lotus Turbo II	£8.99
California Games	£6.99	Maniac Mansions	£8.99
Carrier Command	£8.99	Manic Miner	£7.99
Celica GT4 Rally	£6.99	Man United Europe	£7.99
Centrefold Squares	£6.99	M. Jackson Moonwalker	£6.99
Chess HQ	£6.99	Midwinter	£9.99
Cloud Kingdom	£6.99	Mig 29 Fulcrum	£9.99
Colossus Chess	£6.99	Moonshine Racers	£6.99
Combo Racer	£6.99	Murder	£7.99
Conflict in Europe	£7.99	Narc	£6.99
Deluxe Strip Poker	£6.99	New Zealand Story	£6.99
Double Dragon I or II	£6.99	Ninja Remix	£7.99
Dragon Ninja	£6.99	North & South	£6.99
Duel	£6.99	Out Run	£6.99
Face Off - Ice Hockey	£7.99	Operation Harrier	£7.99
Fantasy World Dizzy	£5.99	Operation Stealth	£9.99
F16 Combat Pilot	£7.99	Operation Thunderbolt	£6.99
Flight of the Intruder	£8.99	Operation Wolf	£6.99
F.O.F.T.	£6.99	Outrun Europa	£7.99
Future Wars	£8.99	Pang	£6.99
Gauntlet II	£6.99	Panza Kick boxing	£8.99
Gem X	£6.99	Pinball Magic	£7.99
Ghostbusters II	£6.99	Pirates	£8.99
Ghouls'n'Ghosts	£6.99	Pitfighter	£6.99
Hardball	£6.99	Predator	£6.99

VISIT OUR SHOP
AT
120a
MYDDLETON
ROAD
WOOD GREEN
LONDON
N22 4NQ.
081
889 9172
SHOP PRICES
MAY VARY.

Please make cheques and P.O.'s payable to **Eagle Software**. P&P is £1.00 per item in the UK. Europe: add £3.50 per item. Elsewhere add £5.50 per item. New titles will be sent as released and are subject to manufacturers price reviews. E.&O.E. PLEASE SEND ME MY FREE COPY OF 'THE REVIEW BOOKLET'. # Please quote special offer when ordering for it to apply.

Computer _____ AMIGA _____ Date _____
Title _____ Price _____
Price _____
Price _____
Price _____
Price _____
P & P _____
Total _____

BLITZ

BASIC



GET TOTALLY BLITZED FOR ONLY £49.95

**SAVE
£20.00**



IT'S BASIC
a fully structured
new-generation BASIC

IT'S FAST
faster compiling,
faster code,
faster development

IT'S FLEXIBLE
new commands
released regularly,
or add your own

IT'S GOT
everything from C
structures to inline
assemblers

IT'S HEAVY
nearly 2Kg of pure
power for your Amiga

THIS IS WHAT YOU WANT...

- A huge 320-page A4 reference manual
- A separate user friendly user guide
- The first four issues of *Blitz User* magazine
- Five disks packed with extensions, games, examples and more
- A registration card which, should you choose to use it, will get you...
- A fifth issue of *Blitz User* magazine, and a sixth disk featuring over 30 new *Blitz* commands including AGA specific extensions
- All you need to create your own stand-alone programs

...THIS IS WHAT YOU GET!

From the beginner to the advanced Amiga programmer, *Blitz Basic 2* offers a new-generation environment tailored to the demands of creative minds everywhere.

Please send me my complete *Blitz Basic 2* advanced user pack. I enclose £49.95 to cover the amazing bargain price of this offer.

Name _____

Address _____

_____ Post Code _____

Phone Number _____

METHOD OF PAYMENT: (Tick as appropriate)

Cheque Postal Order Access Visa
 Card number expiry

Please make cheques and postal orders payable to Future Publishing Ltd.
 Send this coupon and your payment to: *Blitz Basic 2* offer, *Amiga Format*,
 Future Publishing Ltd, Cary Court, Somerton, Somerset, TA11 6TB.

CODE AMF-BB2

NEW EQUIPMENT SALES

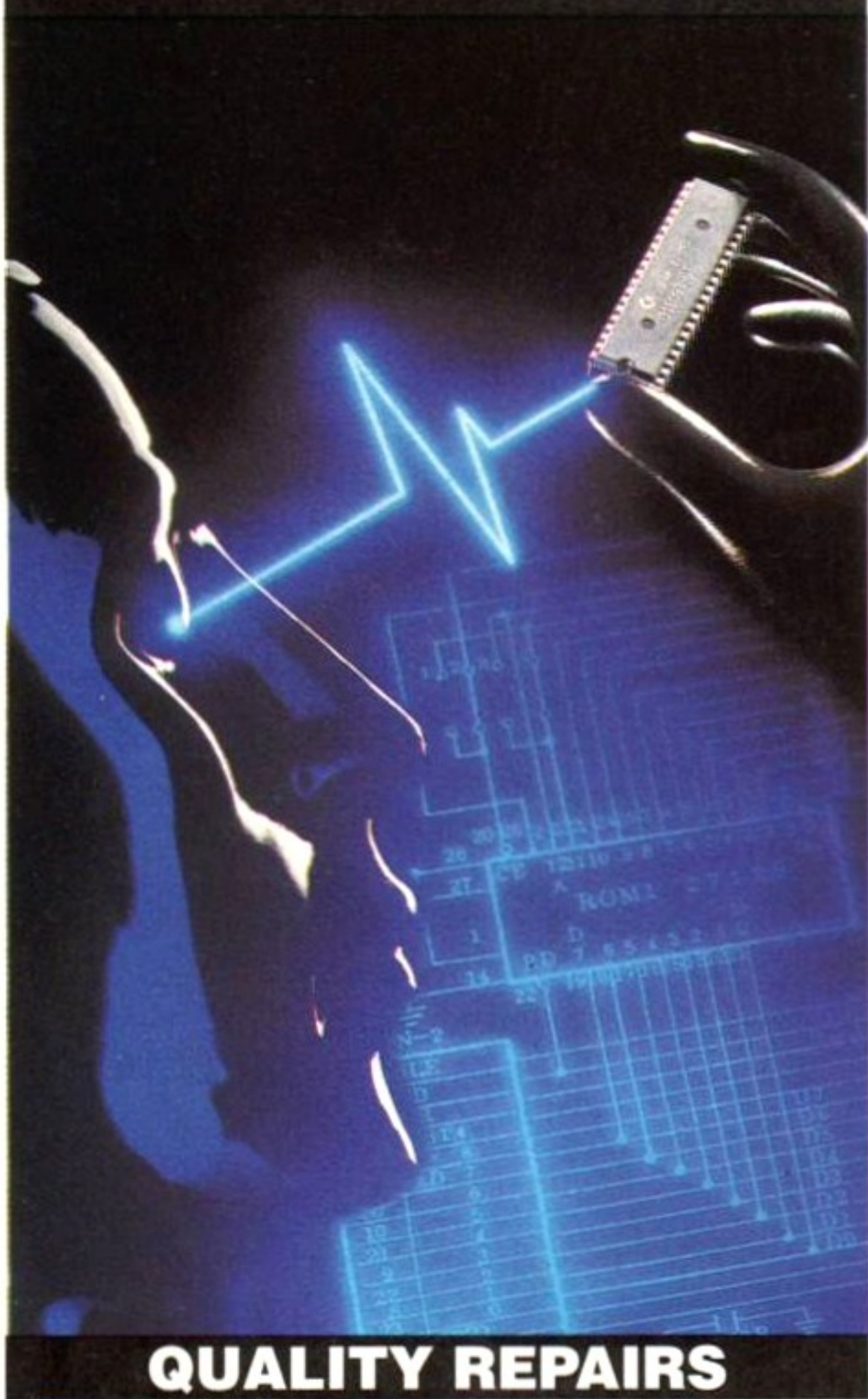

QUALITY REPAIRS

ACS Electronics is an established centre for AMIGA equipment. We specialise in the repair, maintenance and supply of computer hardware. Dedicated to a programme of quality customer care, our established position in the industry enables us to offer you, our customer, a service that we believe to be second to none.

NEW HARDWARE SALES

Amiga A500+			£179.99	A3000 2MB VID/4Mb FAST/52Mb	£1149.00
A600 1Mb	ALONE		£185.99	A3000 2MB VID/4Mb FAST/120Mb	£1299.00
A600 1Mb	20HD		£299.99	AMIGA 4000/30-/40	£P.O.A
A600 1Mb	40HD		£329.99	CALL FOR SPECIAL AMIGA PACK PRICES	
A600 1Mb	85HD		£429.00	COMMODORE CDTV	£249.00
A1200 2Mb	ALONE		£364.00	A600 CONTROL CENTRE	£P.O.A
A1200 2Mb	20HD		£495.00		
A1200 2Mb	60HD		£529.00		
A1200 2Mb	80HD		£575.00		
A1200 2Mb	120HD		£639.00		
A3000 1Mb	VID/1Mb FAST/52 Mb		£999.00		
A3000 1Mb	VID/1Mb FAST/120 Mb		£1149.00		

MONITORS/PRINTERS/PERIPHERALS/CHIPS!
CALL FOR BEST PRICES, REVIEWED WEEKLY.
PRICES INCLUDE V.A.T.
CARRIAGE FREE TO UK MAINLAND.

REPAIR SERVICE

FAST EFFICIENT SERVICE
most repairs are carried out within ONE DAY
QUOTATIONS RATHER THAN FIXED PRICES
fairer to you, and in practice faster to process. Each repair is quoted separately,
no fixed charges full of exclusions, or hidden extras.
REPAIRS FROM £23
FREE CARRIER SERVICE with insurance
FREE 90 day warranty, FREE soak test.
No hidden charges.
FREE diagnostic inspection, FREE software.
OPTIONAL EXTENDED WARRANTY
at competitive rates.
Experienced and qualified engineering and support staff.
5% DISCOUNT
available to students and OAP's.
UNBELIEVABLE UPGRADE FITTED PRICE OF £15 INCLUSIVE
Trade and Education welcome. Dealer pack available on request.

Credit facilities
available soon for
hardware purchases
(subject to status)



WE HAVE MOVED! TO BIGGER AND MORE ADVANCED PREMISES!

ACS DESIGN WORKS, WILLIAM STREET, FELLING, GATESHEAD NE10 0JP
TEL: (091) 495 0300 (10 Lines) FAX: (091) 4950440



ALL DISKS NOW
ONLY
£1.05 EACH!

All disks work
with the A1200!
unless stated

Anglia PD

Catalogue Disk (P)
only 70p - Includes a
superb Scenery
Generator!

(P) = Works on A500, A500 Plus and A600

HOME MANAGEMENT PACK 3 DISKS (P) £3.15
Calendar, Mortgage, Spreadsheet, Grammar, Mileage, World Time, Budget, Chequebook, Database, Typing Tutor, Typewriter, Grocery, List Maker, Home Banking

CLIPART PACKS 1, 2 OR 3 EACH PACK = 5 DISKS £5.25
3 different packs of 5 disks, all full of the very best clipart for DPaint etc. (P)

PC EMULATOR PACK (P) 3 DISKS £3.15
Turns your Amiga into a PC! Includes the latest PC task which now gives true VGA Resolution (if you have a 1200) and includes 2 disks of PC Public Domain software.

ANGLIA COLOUR FONTS PACK 1 OR 2 (P) 5 DISKS £5.25
5 disks full of original colour fonts produced here at Anglia. There are 16 colour fonts - not cut and paste! They are produced in the same way as the chisel font supplied with DPaint and the Kara range of commercial fonts! They are typed straight in and work with Dpaint and TV Text.

ANGLIA CLIPART PACK (P) (NEW) 5 DISKS £5.25
Brand new IFF clipart produced by Anglia! Loads of high quality anti-aliased IFF images including cats, dogs, birds, wild animals, people and characters. Use with DPaint or any program that accepts IFF graphics.

ASTRONOMY PACK (P) 4 DISKS £4.20
This superb pack now includes: Star Chart, Amisizer, Total Concepts, Astronomy, Gravity Well, Grav Sim, Orbit, Planet and Fast Facts on the solar system.

PRINTER USER PACK 2 (P) (NEW) 4 DISKS £4.20
A completely new collection of programs to help you get the best out of your printer! Includes: Diskprint V3.51 (Disk labels), MICMaster (Cassette covers), Printfiles, JBSPool, Enviprint (Envelopes), New Print (Margins - Headers Footers etc) and more.

DISK EXPERT PACK (P) 5 DISKS £5.25
If you want to learn more about your Amiga, get this pack! - You'll be a disk expert in no time! Includes Power Packer (Easy file compacter), Sid (Brilliant CLI Replacement Tool!), Iconmania (Change any Icon in seconds), Fixdisk, Viruschecker V5.3, D-Copy (Copies, Repairs, Formats and more), CLI Tutorial (All you need to know) and 200 other utilities!!!

"C" PROGRAMMERS PACK (P) 6 DISKS £6.30
A complete "C" language and superb instruction manual provide all you need to learn the "C" language, includes North C (2 disks) and the C Manual (4 disks)

MED V3.21 MUSIC PACK (P) 4 DISKS £4.20
MED is widely recognised as the best music package, PD or otherwise!! This pack contains V3.21, the latest version complete with loads of digital samples, a disk full of MED music scores and some great MED music to load and play! Listen to what your machine is capable of!

CLASSIC GAMES PACK (P) 5 DISKS £5.25
An incredible collection of superb commercial quality arcade games! Hours of fun for both kids and adults. Includes: Defender, Galaxians, Scramble, Missile Command, Pac-Man, Bi-Planes, Drip!, Space Invaders, Asteroids, Breakout, Tetris + more!

CARD + BOARD GAMES 2 (P) 4 DISKS £4.20
Another outstanding collection! 38 very good "Thinking" Games! Chess V2, Backgammon, Blackbox, Towers, Pipe, Zerg, Maze, Connect4, Dominoes, Draughts, Othello, Go Moku, Dragon Tiles, Klondike, Canfield, Mastermind, Wordsearch, Hangman, Pontoon and many more.

COMPUGRAPHIC FONTS PACK 1 (P) 3 DISKS £3.15
36 Scaleable Compugraphic fonts on 3 disks. They work with Workbench 2 or 3, Pagestream V2+ (on any Amiga), Propage 3+ and Pagesetter V2+. Excellent fonts and great value for money!

HARD DISK PACK 2 (P) 3 DISKS £3.15
Great collection of the latest hard disk utilities includes HDclick (menu maker), fileminder (directory etc.), a backup (superb!), superlock (password protect every drive, mouse and keyboard!), disk optimizer, copier, virus killer and more!

AGA PICTURE PACKS 1, 2 OR 3, EACH PACK 5 DISKS £5.25
3 different packs of 5 disks full of stunning pictures that show off the enormous graphical capabilities of the new AGA machines. You must have an Amiga 1200 or 4000.

A1200 PACK (A1200 ONLY) 3 DISKS £3.15
All of the essential software for your A1200! Includes: Fake Fast MEM, A1200 Run, Degradar, Sysinfo, Viewtek, Plasma, Winblend, Kill AGA, Tetris.AGA and more! Also includes the stunning Iyapurovia.AGA create wonderful patterns and pictures with full AGA support!

PLATFORM PACK 4 DISKS £4.20
All of the best games in the style of Sonic and Mario Bros. If you like those games then you'll love these! Includes: Wizzys Quest, Wonderland, Wibblygiddy, Doody, Crazy Sue II, Roach Motel, Son of Bigger and More!!

HOME BUSINESS PACK (P) 4 DISKS £4.20
Designed especially for newcomers to business software, this pack contains a database (Bbase), spreadsheet, accounts package and Wordprocessor (QED). Also included are a 12,500 word spelling checker and a word statistics program!

HOME BUSINESS MANUAL (P) £2.99
Approx 50 page professionally printed manual containing full instructions for the Home Business Pack. Includes a specially written guided tour section that takes you through the major features of each program and ensures that you can use each program with confidence!

SINGLE DISKS AT ONLY £1.05!

BUSINESS
B351 (P) Amigafox (English Desk Top Publishing)
B352 (P) 600 Business Letters (Superb! - Ready to use)
B357 (P) Text Engine V4 (now the very best wordprocessor with built-in 36,000 word spell checker!)
B347 (P) Address Print V3 (easy to use address label printer)
B335 (P) Forms unlimited (Design invoices etc, quickly)
B339 (P) A-Graph V2.0 (new version - easy graphs!)

UTILITIES
B348 (P) Easy Calc (The best Spreadsheet yet!)

UTILITIES
U437 (P) D-Copy V2 (Now an even better disk copier!)

CHILDRENS
C712 (P) Colour Pad (New colouring book for youngsters)
C720 (P) Colour the alphabet (Great education for early learners 4ys+)
C726 (P) GCSE Maths (Great revision disk)
C727 (P) Top Secret (Reviewed as the best platform game ever!!)

CHILDRENS
C729 (P) Counting Fun (For age 4+, Excellent simple arithmetic practice)
C730 (P) Wizzys Quest (Wizard, Damsel + Monsters, great game!)

CHILDRENS
C733 (P) Giddy! (a game like Dizzy - brilliant!)

CHILDRENS
C734 (P) Crazy Sue II (excellent platform game!)

CHILDRENS
C735 (P) (2 disks) Nursery Rhymes (sing-a-long favourites)

U4028 (P) Printer Drivers (Over 100 - Most Star + Citizen models including colour and HP500C)

U4036 (WB 2/3 only) Kick 1.3 (lets you use WB1.3 software)

U4038 (P) DPaint tutor (easy route to Pro Graphics)

U4043 (P) Superdark (brand new screen blanker with over 20 patterns - superb!)

U4050 (P) Amiga World V1.1 (Info on every country on earth!)

U4054 (P) Disk Manager III (the finest disk catalogue prog)

U4057 (P) Engineers Kit (A health check for your Amiga!)

U4058 (P) Astronomy V2 (New Stars + Planets Prog)

U4059 (P) Astro 22 V3 (Professional Astrology)

U4060 (P) Starview (new astronomy program)

U4061 (P) (2 disks) Dice C (Full C Compiler)

U4062 (WB 2 or 3 only) N Comm 3 (Latest comms package)

U4063 (P) FM Synth (Superb Full Synth - two octaves on Amiga Keyboard)

U4064 (P) Supervisor (Excellent Slideshow Maker)

U4065 (P) Pools Wizard (Bang up to date forecaster)

U4066 (WB 2 or 3 only) Diskalv 2 (fixes problem disks)

D139 (WB3 only) Planet Groove (stunning AGA Demo!)

M920 (P) Octomed 2 (latest version of Music Maker)

M922 (P) X Beat (Nice drum and bass sequencer)

GAMES
G6036 (P) Total War (Perfect version of The Risk board game)
G6042 (P) Super Pacman 92 (the best ever)
G6051 (P) Bridge (The full card game - special A1200 version included!!)

G6053 (WB 2/3 only) GNU Chess (excellent graphics - the best chess game yet!)

G6056 (P) Cash Fruit (probably the best fruit machine ever!)

G6061 (P) Artillerus (Like Tarx but Better - Great Fun!)

G6063 (P) Son of Bigger (Excellent Platform Game)

G6064 (P) Solitaire Sampler (5 Full Versions of the Card Game!)

G6065 (P) Amosloadsamoney (Latest Fruit Machine)

G6066 (P) (2 Disks) 18th hole (The best golf game available!)

G6067 (P) Fruit Salad (Fun Platform Game)

G6069 (P) Premier Picks (Excellent Football Cards Game!)

GR836 (A1200 only) (2 disks) Nightbreed AGA (good AGA Slideshow)

GR837 (A1200 only) Cynostic Slides (more good pics)



DESKTOP VIDEO PACK 2 (P) (100%) 4 DISKS £4.20

Probably our best pack yet! Provides everything to start you off in video. 5 Movie for Smooth scrolling titles using any font of any size. Showiz for slideshows with loads of wipes and fades. A-Graph for business videos: Shadow Maker to add shadows and smooth any font. Video Librarian: Video Tools: Video Tests: Loads of fonts and more!

DESKTOP VIDEO PACK 2 INSTRUCTION MANUAL!!! (P) £2.99

A 50 page instruction manual for DTV pack 2. Professionally printed, contains instructions for all the programs in the pack and a section on fonts and how to use them! Also includes a superb guided tutorial that takes you through the major programs step by step, letting you create your own titles as you go! Designed for beginners and experienced users, this manual will make desktop video easy!

FISH DISKS IN STOCK 350-910 ONLY £1.05 EACH!

FULL CLR RANGE IN STOCK! SEE CAT DISK FOR DETAILS

HIGH QUALITY HARDWARE
8mm High Quality Mouse Pad£2.99
Amiga 500/500+/600/1200 Dust Covers£3.99
Phillips 8833 Monitor Dust Cover£4.99
3.5" Disk Drive Cleaning Kit£2.99
Printer Stand (fits all Dot Matrix Printers)£5.60
Blank Disks (high quality with labels)£0.50

ANGLIA PUBLIC DOMAIN LIBRARY
(Dept AMF), 30 Victoria Street, Felixstowe IP11 7EW

Access VISA CARD ORDERS
International orders welcome but please add 30p per disk for post & packing.
CREDIT CARD
PHONE 0394 283 494

You already know that there are some excellent free and Shareware programs in the Public Domain. But do the latest releases from the world of PD measure up? We gave Richard Baguley a tape measure and a notebook and sent him merrily on his way to find out...

PD Update

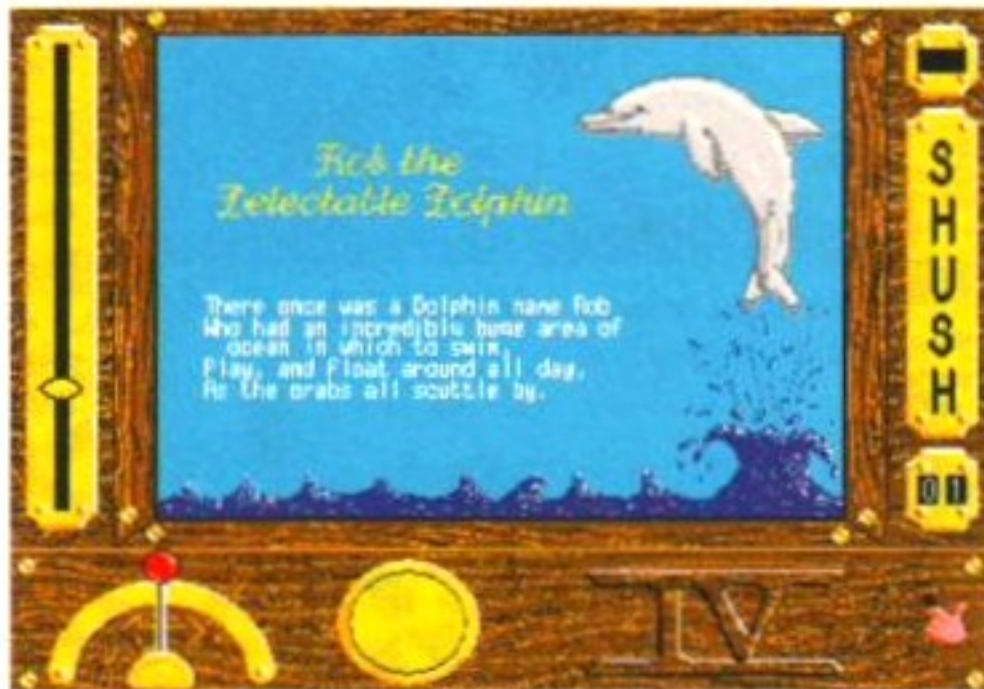

Rob the delectable dolphin? Looks rather more like Derek the demonic dolphin to me...

LUNCHTIME ISSUE IV

MAG

ROBERTA SMITH PD

Most disk mags contain something to do with computers. Not so *Lunchtime*. According to the authors, it was the result of seven ugly people being nailed to desks for ten months without any food, water or other facilities. Yes. Right. Well, the result is decidedly odd. Articles range from the truth about cross channel ferries, to speculations on the possibility of extinct animals roaming the seas, and a poem about a celebrity dolphin.

Several bits are rather, erm, adult in tone (and one or two are somewhat blasphemous), but if you're interested in the weirder side of the Amiga community, *Lunchtime* is certainly worth a look. Furthermore, unlike most disk mags, it's freeware, so you can pass it on to as many people as you like.

FRUIT SALAD WACK PD

GAME

One day, the people of Blobville were engaged in their favourite pastime of jumping up and down in a rather aimless way, when nasty Triax suddenly



Being harassed by blobbies who have been transformed into fruit must count as one of life's major downers.

appeared and turned the hapless blobbies into vegetables in order to guard his gems. However, he missed one blobby by the unlikely name of Brewster, who then set out to collect all of Triax's gems and save his friends from being stir-fried. Pausing only to put on his shades, he embarked on a multi-screen platform quest.

All right, so I nicked that last bit from the introduction to *Fruit Salad*. Anyway, this is a pretty

good platform game, even if the sprites are a bit small. There are several nice touches, including the way Brewster coughs and taps his foot if you don't move fast enough, and some good samples accompany his prodigious leaps.

It's difficult, but with patience, you should be able to get on reasonably quickly. It's released as shareware, for a very reasonable £5.

Continued overleaf

STARBASE 13 MAGNETIC FIELDS GA023

GAME

A graphic adventure based around - surprise! - a starbase. Something nasty has happened and three nasty Stingons have been detected somewhere in the station. You, the heroic shade-wearing captain Yeno, have been sent to work out what's going on.

It's a point-and-click style of game, similar to *Monkey Island* or *Lure of the Temptress*, although it's nowhere near as polished. However, it has good graphics and some neat sound effects. A menu bar gives you access to seven commands, and you can apply these to objects on the screen. For instance, if there was an Editor wandering around, you could click on shoot and then click on the Editor to give him what he deserves.

It's not a huge adventure, but it's certainly big enough to keep you occupied for a few hours.



The intro sequence to *Starbase 13* sets the scene. You are the cool-looking dude on the right in the shades.

The graphics are pretty good, and the control system works pretty well, although it's not very intelligent. For instance, if you want to examine an object that's behind something, you have to



Ahah! An Amiga release rumour started! This one has a 68090, 33Mb chip ram, Digital Washing-up Processor.

manoeuvre your character round it before examining. But, these are only minor complaints, and Edward Clay has done an excellent job of designing and coding the game using *AMOS Professional*.



SampleMaker in action. This program can be used to create your own drum sounds without ever going anywhere near a sampler.

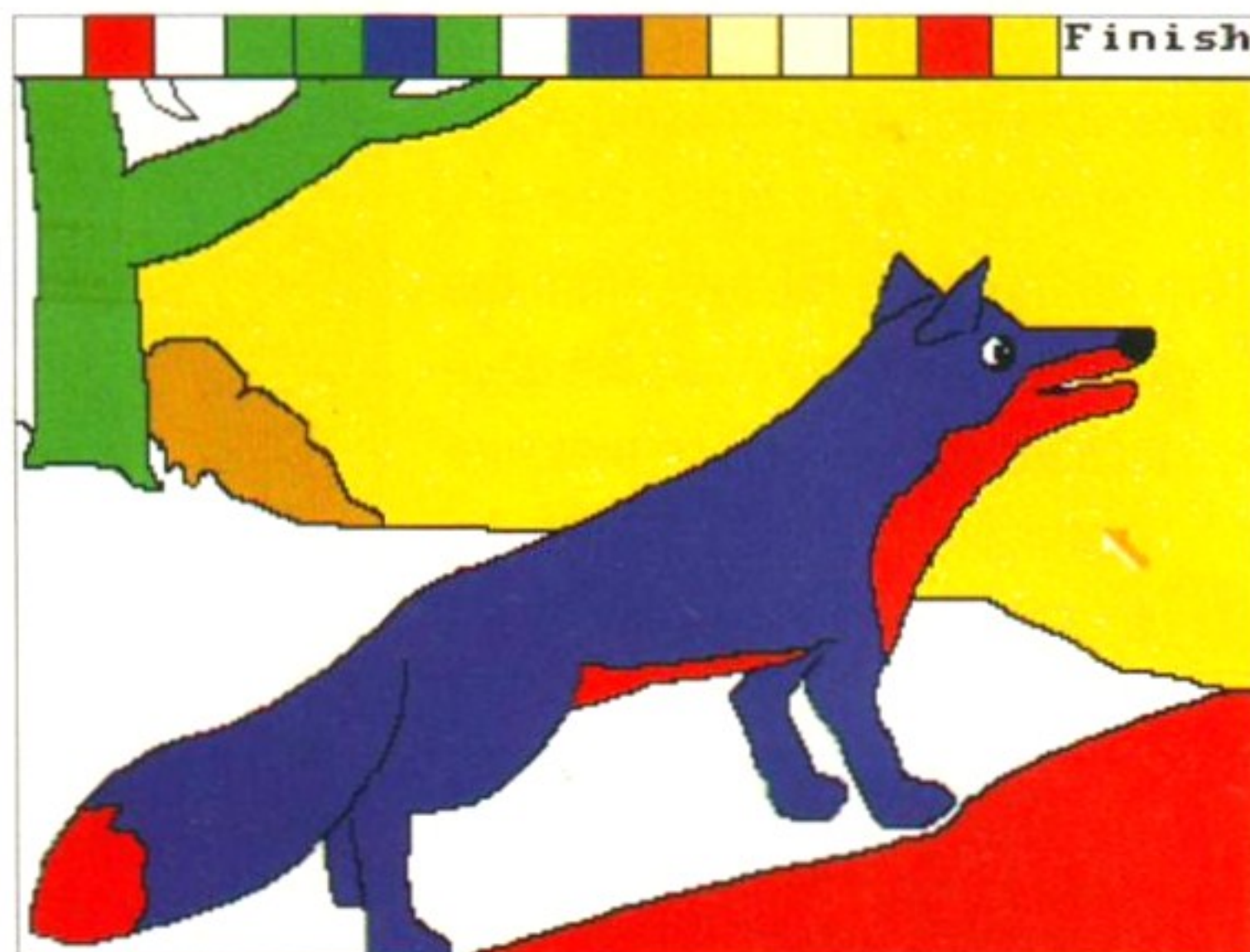

What's wrong with a red and blue fox? I think it looks rather cute. Storyland includes a painting section, in which the wicked witch has stolen all the colours.

NO SAMPLER? UTIL MED USERS GROUP

A disk for Amiga musicians who don't have a sampler may sound like a strange idea, but you don't actually *have* to have a sampler and if you have this disk, you don't even have to have the sample itself. So long as you have a PD disk which has a tune using the sample you want, you can get this disk and run one of the sample rippers on it.

The ripper will search through memory and inform you if it finds any samples or song modules. You can then save them out to disk and load them into *MED* or *Soundtracker* to include in your own tunes. This disk includes four different sample rippers, so one of them should be able to find the samples if they're still in memory. Also included is *Samplemaker*, a program which enables you to create samples from simple waveforms.

It's pretty buggy, (as in trying to access DH1: when I don't have a second disk in the machine) but the demo songs contain some strong drum sounds, and with a judicious bit of fiddling it can produce some really pleasant noises.

STORYLAND 2 EDUC MAGNETIC FIELDS ED021

Storyland is not a happy place. A wicked witch has taken over and has been doing nasty things like spraying graffiti everywhere and stealing all the colours. So, it's down to you as the champion of justice and freedom to beat the witch armed only with a teddy and a packet of felt tip pens.

As you may have guessed, this title is aimed at the younger end of the market. It's a simple point-and-click-type adventure, with several colouring-

book sub-sections included. It's not particularly difficult, but it may serve to keep your offspring occupied for a few hours. It's designed and written by members of an animal rights group who don't hide their beliefs, so only for right-on families.

DEGRADERS UTIL VIRUS FREE PD 3356

If you own a shiny new A1200 or A4000, you will no doubt be aware that many games won't run on this new machine, particularly older games. In order to run these games, you'll need to use one of the several programs that gets your machine to pretend it's an older one. Virus Free PD have put together a disk full of programs for this, including *Degrader*, *KillAGA2* and *Fakemem*.

The most useful is *Degrader*, which you can use to alter numerous parameters on the machine, including whether it's a PAL or NTSC machine, how much chip RAM it has and what floppy drives are attached. You can even exclude specific areas of memory which cause your programs to crash.

Also included on this disk are *Kick 1.3* (which reboots your machine using a copy of the Kickstart 1.3 ROM held on the disk), *KillAGA* (which disables the AGA chipset without rebooting the machine) and *Fakemem*, which you can use to cut your machine down to 512K of chip memory.

WORLD WAR II ED HYPERBOOK MAGNETIC FIELDS ED006

Facts and figures about the Second World War abound, and Asgard Software have taken a large wedge of information and tried to make it fun and presentable by putting it in Hyperbook form.

You are presented with a menu about various aspects of the war. Choosing a subject moves you on to a screen with other topics, and you click on one to see the next screen.

What makes presentations of this kind good is ease of use and the quality of the images. This is easy to use, but the images have been badly scanned and cropped. The designers have put in a lot of effort, but the result is disappointing.

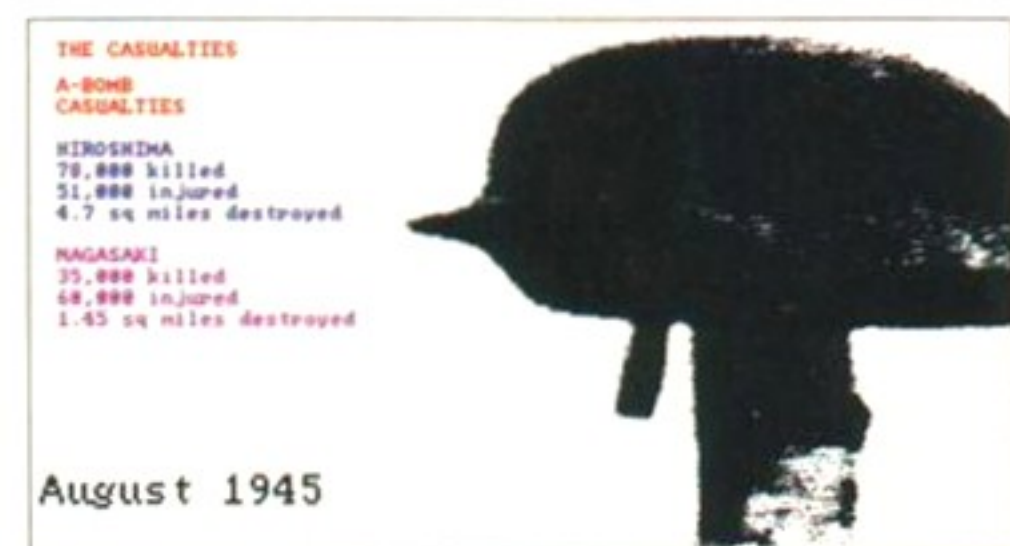

The World War II Hyperbook contains lots of useful information, but much of it is badly presented.

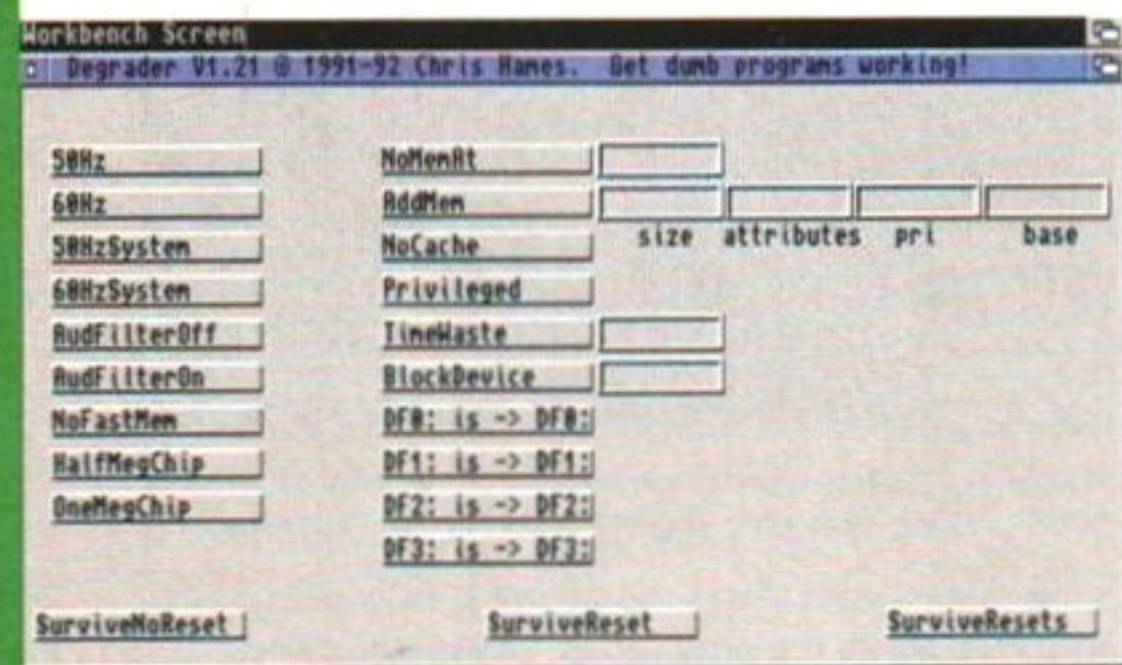

Degrader enables you to turn individual parts of your machine on or off. Combine this with other programs on the disk, and you could run almost anything...

THIS MONTH'S TOP 10 GAMES & UTILITIES

Every month we peruse the bestseller lists of a prominent PD company to see what games and utilities are selling well. This month, it's the turn of...

CHOICE SOFTWARE

1	Dragon Cave	GA186	6	Apple Catcher	GA083
2	DCopy 3.1	UT120	7	Fakemem	UT122
3	Wibble World Giddy	A165	8	Fighting Warriors	GA082
4	The Great Escape of Billy Burglar	GA038	9	Workbench 3 Utilities	UT319
5	Kick 1.3	UT112	10	Electric Clown	WP disk WP002

WHERE TO GET THE DISKS IN THIS ISSUE

MED USERS GROUP: 6 Glevum Road, Stratton St, Margaret, Swindon SN3 4AF

Hampstead Garden suburb, London NW11 6JE

WACK PD: 48 Emerson Ave, Middlesborough, Cleveland TS5 7QH Telephone 0642 822545

MAGNETIC FIELDS: PO Box 118, Preston, Lancashire PR2 2AW Telephone 0772 881190

ROBERTA SMITH PD: 190 Falloden Way,

VIRUS FREE PD: 31 Faringdon Road, Swindon Wiltshire SN1 5AR Telephone 0793 512321



CUT, TICK & POST... CUT, TICK & POST... CUT, TICK & POST

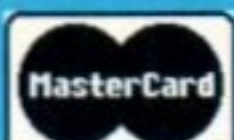

TELEPHONE 0702 466933 Fax 0702 617123



PD SOFT (AF52) 1 BRYANT AVE, SOUTHEND-ON-SEA, ESSEX, SSI 2YD

EDUCATIONAL DISKS

- V13 PLAY & READ CHALLENGE (2) Education programs for the under 7s
V546 KIDS PAINT A painting program designed for children.
V584 FASTFACTS Everything you ever need to know about the solar system
WORLDMAP Produce Maps. PLANETS
V792 KIDS GAMES Geography Math, Science and Word Games.
V793 AMIGA BEGINNER You asked for it! Tutorial for the beginner on using your Amiga! Covers CLI & Workbench.
V824 ELEMENT v3.0 Nice interactive display of the Periodic Table.
V825 WORLD DATA BANK v2.2 Using a database of coordinates of the CIA's, it plots the world map's in cylindrical or spherical projects in degrees of magnification.
V843 DESERT STORM Select Maps & info surrounding the Attack.
V849 LANGUAGE TUTOR v1.0 Spanish, French, German & Italian.
V908 DPAINT TUTOR Do you have DPaint, learn how to use it.
V927 CU TUTOR Helpful program to understand how to use CU & Shell.
V933 GCSE MATHS Program to help with the GCSE maths course.
V940 MATHS4AD Simple math problems to solve. REFLEXTEST Tests
V944 AMIGAWORLD Contains information about every country.
V1015 JAPANESE Help teach Japanese. Word-a-day & Vocabulary.
V1111 CHILD QUIZ Simple Quiz game with colourful graphical pictures from ages 5 upwards. Excellent little game

FULL REGISTERED VERSIONS

- COMPLETE A64 PACKAGE v2.0 With interface & Full Commercial software. Transfers disks from your original 64 disk drive. Full version of the program £44.99
CROSS SITCH Prints out a picture in a pattern for embroidering £16.99
GSI FORMULA ONE is a management game on the Amiga £4.99
G52 POWERBASE is a database that should cater for everyone's needs. Stores up to 10,000 records. £4.99
G53 EARLY LEARNING MATHS Teach young children ages 5-9 £4.99
G54 SPELLIE COPTER One of the best educational games. £2.99
G56 SUPER SOUND v4.22 A completely new version with loads of extra features £4.99 or £12.99 with a full Printed Manual and software.

VARIOUS UTILITIES

- V16 AQUARIUM Turns your screen into an eye-catching fish tank.
V109 PRINT STUDIO Excellent for printing graphic pictures or text.
V125 DISKMANAGER v3.2 Copies files from one disk to another.
V262 DUPLICATION & BACKUP Superduper Turbo copy, Sanity copy
V277 FORTRAN-77 v1.3c Compiler, linker & run time support libs.
V298 NORTHIC v1.3 Complete C language with all files needed (2)
V301 EYE OF THE BEHOLDER Disk Book with Maps, Strategy & Solution.
V323 ANALYTICAL SPREAD SHEET The best spread sheet. (2)
V332 AMIGA PUNT PROGRAM Predict which horse will win the race.
V350 BUSINESS CARD MAKER Design your own Business cards.
V366 600 BUSINESS LETTERS Over 600 Standard Business letters
V390 DESK TOP PUBLISHING Extra features, Text & Graphics Editors
V392 AMICASH BANKIN Best bankin program that I have ever used
V394 CHEMESTETICS v2.14 Draws molecules using the calotte model.
V401 WINDOWBENCH (2) Give your Workbench v1.3 a stunning new look and update your aging software.
V424 ANTI-FLICKER Said to stop the flicker in High Res mode
V444 PRINTER DRIVER DISK III Now contains instructions on how to install them. There's about 90 drivers
V479 CHESS & UTILITIES A collection of chess related Puzzles.
V489 AMIBASE PRO v2.0 This is most popular PD Database program.
V490 MESSY SID v2.0 Reads MS-Dos disks, Transfer any file files & from an IBM PC, ie PC to Amiga
V523 DICE C COMPILER (2) Matthew Dillans full featured powerful C compiler & environment system.
V536 CATALOGUE UTILITIES A collection of utilities used to Catalog disk/ Video & Tape collections (2)
V567 GENERATORS Selection of utils & Printer Driver Generators.
V569 DUNGEON MAPPER v1.1 Can design maps for dungeons & Towns.
V573 FILE & HD HDClick v2.0, File Minder, DosControl, & tools. (2)
V575 HOME BUSINESS Based on word processing, Data Management, Spreadsheets, Accounts & Printing. (6)
V583 ICON EDITOR III v2.0 Create icons up to 640x200. Edit or Create
V587 ELEGANT FONTS (2) If you want some coloured DPaint fonts.
V610 GOLF SCORES v1.84 It will record each round you play. Store it, make up an eclectic score NEW!
V611 FOOTBALL LEAGUE EDITOR v1.1 Want to update your teams league position as the results come in.
V620 ASPICE v3.2 Full featured program for electric circuit.

- V624 NIB COPIER v2.0 Will copy in AmigaDos & special parameter copy.
V627 DPAINT FONTS No's 1-3 (3) The latest selection. Fonts for use with any IFF Pointing / DTP Program.
V635 IBM EMULATOR v1.5 is a CGA Colour IBM-PC Emulator written to run on any Amiga. Shareware version
V660 HOME MANAGER is an addressbook/inventory database. 2-do list
V661 VERTEX Create 3d objects without using the X, Y & Z views. Loads Sculpt 3d+
V662 DCOPIY v3.1 PRO You can select the speed of the disk drive, Copy modes, Dos, Nibcopy, Ver & safecopy (Fully updated version)
V678 DRAW MAP v4.1 You can generate world maps in detail views. 3d or 2d. 2Mb (2) or 1Mb V2.63
V681 GAME TAMER v4.01 Get a hold of that extra hard game & Cheat
V684 FPD EDITOR v1.0, Also contains other utilities. IFF Fonts
V685 ASTRO ASTROLOGY v3.0 Best Astrology program on the Amiga
V686 MULTIDOS v1.12 After this program has been installed your Amiga drives can then read 720k IBM Disks.
V688 MAGNETIC PAGES v1.30 Creates disk based mags with graphics
V690 WB 2/3 UTILITIES Contains the programs that should have been with WB 2. Take full advantage of the many NEW capabilities that are available. (2)
V693 HARLEQUIN VIDEO ART A video production with backgrounds. (3)
V698 AGRAPH v2.0 Brings the world a cheap draw Bar, Line, Area & Pie chart production/ presentation program.
V705 MED v3.21 Excellent update to the famous music program
V710 AREX TUTORIAL Includes several Amos scripts & sample prog. AREX comes free on all WB v2.04+ disks
V711 UNIX Contains a working demo of Minix (Linux) system compatible
V715 BIBLE The entire text of the new Testament & Torah Old Testament (3)
V719 FREECOPY v1.8 Removes protected games copy protection so that the user can install them on HD
V727 ART OF MED 2 Another excellent select of Med tunes.
V731 AMOSBROT v1.1a Logistic Equation, Coast lines & trees Fractals
V733 SOFTWARE LISTER v1.3 This program is designed to keep a track of your Software collection.
V742 ONLINE v1.4 Program will allow you to find cheats within games.
V691 PROFESSIONAL C MANUAL v3.0 is the largest collection of utilities, documents & examples for C. It consists of six manuals, with over 40 chapters (5)
V757 AMIGADEX v1.61 Creates a card index database system.
V758 TEXTPLUS v4.0e Another update of this excellent Word processor program. Requires Hard drive
V759 TEXT ENGINE v4.0 Updated version of the Word processor with AZSPELL. Excellent spell checker
V761 A-GENE v4.18 The most popular genealogy database program
V770 ACCOUNT MASTER v2.12 Excellent Amos written program
V773 WB v2.04 WINDOWBENCH v2.0 Excellent Workbench replacement for all WB v2.04+ Users (2)
V777 VOICE CU v5.5 The idea is to control the CU with your own voice.
V778 RAYSHADE v4.0 Complex Ray tracing package. 2Mb (3)
V782 FORMS Create, Edit, Draw, Colour & print your own forms.
V783 PROGRAMMING TOOLBOX Many programs to help in your development efforts. Most C but some in basic.
V784 AREX (2) disks which contain Amos programs & examples
V786 PASCAL This disk contains everything needed to program in Pascal. Includes 68k 68000 assembler & more.
V787 PROGRAMMER TOOLS GodTools to design your user interface to your own programs using all of Amiga DOS 2.0's new features. Also RegTools
V790 ANIMATION UTILS Includes CyroUtils for splitting, combining, and creating animations from IFF picture files.
V791 DIRECTORY UTILS Highly recommended programs which are designed to make CLI & Shell tasks virtually obsolete.
V794 GRINDER Complete graphic conversion package that supports GIF, JPEG, Atari ST (Neochrome / Degas), PCX, Targa, TIFF, Ham-E and IFF format pics.
V799 ADVANCED UTILS SerNet & ParNet, Connect 2 Amigas & share resources via the serial or Parallel ports. MyMenu WB 2.0 menus
V806 WB v2.04 UTILITIES (2) 2nd collection of WB v2.04+ utilities that take advantage of the NEW capabilities.
V811 ELECTROCAD v1.42 & PRO TOYPER Electronics drawing Programs.
V812 CANON This disk contains Printer Drivers & Canon Disk. Gives better print output for any 9 pin printer.
V815 FILE & HD 2 DirWork v1.62 MegaD File copier like Disk Master (2)
V817 A500 PLUS EMULATOR As it sounds will let v1.3 / v1.2 owners run WB v2.04+ software with out any need to purchase to WB v2.0+ chips.
V818 INSCRIPT v1.1 Produce video titles. IFF Pictures as back grounds
V820 BBBBS v5.7 Baud Bandit bulletin Board System Flures include up to 99 file libraries, interface to extra devices

- V821 SNOOPDOS v1.5 Monitors Dos calls to see what library, devices, fonts are required if a program will not load.
V822 BACKUP v2.43 A hard drive backup program that features, multi-drive support, full backup, compression.
V823 POWERPLAYER v3.4 Very powerful, user friendly module player.
V826 AHDM v3.4 Hard Drive Menu. When placed in your startup- sequence, offers a 16 page menu
V827 REPAIR-IT 2: NewZap v3.3, Sector file editing system. FXDISK v2.3, Recover as much as possible from a defile disk
V841 MODULA-2 Contains modula-2 language on the Amiga.
V842 SID v2.01 Sid can be used for various operations. The best is the file copier on the Amiga.
V844 DELTRACKER v1.3 Powerful & system friendly music player. Will play over 40 difference types of modules.
V845 Q.M.J. v5.31 Generate julia sets & complex Quaternion Julia slices.
V846 SCORPIUS MAPPER An excellent Dungeon mapping program
V847 MONEY MANAGEMENT v1.01 Home accounts which allows you to keep track of upto 12 accounts
V848 SLIDESHOW GENERATOR v3.1 Creates slideshows of pictures in various formats for the amiga.
V850 FRAC v1.1 is a graphical Role playing game creator.
V856 PICTURE TOOLS Converts Pictures to other formats and styles.
V858 MUSIC MAKERS A selection of programs to produce your own music productions. Make your own music.
V859 AUDIO TOOLS (2) Sound and Audio production utilities.
V861 3d DESIGNER Graphic production utilities including Light, DXBTrace
V865 IMAGE PROCESSORS Contains Tools to perform a wide variety of Image Techniques (IFF)
V866 MANDEL EXPLORER (2) This is the best collection of Fractal Generating software on the Amiga
V869 ANIMATION ASST (2) Will make many of your animation programs. Includes Abridge, Players, DA, AnimTools
V871 3d HELPER Are you starting out with 3d graphics. This is what you need
V872 ICON TOOL KIT Just about every tool you could imagine
V873 UGFC v1.1 Will help you translate between Graphic formats
V875 SPACE Help you study, identify the Stars & celestial objects.
V876 SYSTEM TEST v4.1 Checks & reports on your computer
V882 MAGNUM v1.4 Another excellent Disk Magazine Creator
V888 TRONI CAD v1.0 The best CAD program with power functions.
V899 ABACKUP v3.88 A Powerful backup utility that may be used for HD backup & File Archiving. SysInfo
V900 BOOTJOB v1.0 Include functions to store, install, view or execute your bootblock. Can save 88 as executable
V901 FIM v2.2 IntroMaker to create your own intros. IFF imports
V921 COMPUGRAPHIC FONTS Will work with DPaint v4.1, ProPage3, PageStream, Page setter & Workbench v2.04+ About 30 fonts (3)
V924 PLOT MAP v0.85 An extra disk for use with Draw Map v4.0+ will allow use of the program with 512K RAM
V925 SLAUGHTER CHEATS Selection of WB Hacks & Cheats
V928 THE LITTLE OFFICE One of the best disks at the present time. Has a Word Processor and others
V936 LETTERS & BOILERPLATE Letters for you to use as your own or cut & paste into a Word Processor
V942 SCREEN BLANKERS A disk packed with screen blankers. Includes the Twilight Zone blanker along with 10 others
V943 LYAPUNOVIA v1.5 Mind-bogglingly colourful program that makes pictures from a mathematical formula. Now with AGA support
V945 PROPAGATE 3 ENHANCER Over 40 Genies for use with ProPage 3.0, including useful ones like Make Pie Chart. Also structured clipart for unique borders!
V946 SYSTEM OPTIMIZER KCommodily gives you memory meters. REorg will optimize hard / floppy disks for big speed increase. HDMem virtual compression. 2 Meg of HD space to 2Mb
V947 GNUPLOT is a command driven interactive function plotter. Creates stunning plot/graphics of mathematical functions. Requires a hard disk drive
V948 INTUITION BASED BENCHMARKS v6.0 A great package with all the popular BMS like Sieve, Dhrystone, Savage, iMath & Matrix.
V949 TESTS Contains all of the classic speed tests & system checks we could find. Includes CPU Speed. A full featured system diagnostic tool & more.
V951 PROTECTION is a collection of utilities aimed to protect your data and protect auto booting HDs & Document File. Lock your data files with a password
V952 X-BENCH v1.0 (2) Complete solution to the replacement Workbench. Contains Lashhope, View, Virus Checker, Power packer & DCopy2
V957 TACKS v1.2 Help you create self-booting animation disks.
V958 CLUB LEAGUE is a utility that will allow you to edit and keep track of your divisions/league stats.

- V959 AMIGA E v2.1b Specific compiler. E is a powerful and flexible procedural programming language
V962 SUPER KILLERS v3.0 (2) The latest Virus Killers like BootK v5.23a, which can save any bootblock and install it on another disk as well as check for viruses. VC v6.28 and Virus2 v3.06
V976 WB v2.04 UTILITIES 6 Next collection of WB v2.04+ utilities.
V977 FILE & HD No 5-6 Next Excellent collect of HD utilities. (2)
V979 NCOMM v3.0 is a communications program based on Comm v1.34 with lots of very nice enhancements A500+ A600. A1200 users machines to run software that would NOT normally work. Turns them into a Workbench 1.3.
V983 MEGA CHEATS v3.0c Now contains over 500 cheats.
V984 PROTRACKER v3.0e The latest updated version from Norway. Various bugs fixed and 70 new features
V988 ZIPBENCH v4.0 Another Workbench replacement but contains excellent utilities like, powerpacker v2.2a, powerplayer, SysInfo, VirusX, Archiver, B-Base, BootInfo, Degrador, Fst Aid Box (2)
V994 THE MONEY PROGRAM v1.5 Features include upto a maximum of 60 accounts, upto 50 direct payments.
V1000 GRAPHPRO v1.0 Written with Amos pro by David Jordan. Basically takes a set of data, plots them on a graph.
V1001 VMORPH v2.21 Will allow you to create smooth morphs/warps between two different images over a period of frames to create an animation.
V1002 RAMOS PRO If you have Amos Pro then this disk will make your programs Boot without the program disk
V1003 NICKPREFS is an enhancement to WB 2/3 which adds 3 new preferences WBPicture, BuzzyPioneer & Floppy.
V1005 WORKBENCH 3.0 UTILS Contains the first batch of A1200 and A4000/030/040 Utility programs
V1009 TURBO TEXT v1.1 Excellent Word Processor. Very impressive version
V1013 POOLS PREDICTION A helping hand with the Pools.
V1016 OCTAMED v2.0 Music editor which was designed for making music for programs. (Full & New Version)
V1017 POST v1.86 An excellent Postscript interpreter for the Amiga which implements the full Adobe language (3)
V1021 WB 3 SCREENS Enhance your Workbench disks backgrounds with these nice full coloured pictures
V1022 LITTLE TRAVELLER v1.1 Shows a world map & you can select any country for travel information. Zooms up another close up map with more detail.
V1023 QUIZ Contains Questions & Answers with the option to add
V1024 MANDELSQUARE v1.6 Generate enhanced AGA Mandelbrot set images, requires numerical coprocessor. You can create 256 colour coloured pics
V1025 TERM v3.1 Comm program, Xpr transfer, filetype id after download, cut & paste, point-and-click, auto upload/download, VT102/VT220, Ansi emulation, powerful phone book & AGA support (3)
V1034 ADM v1.01 Flexible address database with loads of great features.
V1035 FES BASIC Just in time for all the new machines which do not have Basic with their machines any more.
V1037 (AGA) A1200 WB HACKS An excellent collection of Utilities & Hacks
V1038 AMOS PRO UPDATER v1.11 1st Update to the Amos Professional
V1039 (AGA) WB3.0 INSTALL If you need to install your A1200 HD then you need this. Also see V1075
V1040 DBASEIII v1.3 An easy to use, versatile, yet full featured database. Greatly enhanced successor to DBASE II
V1041 DIGITAL BREADBOARD Full featured digital circuit simulator
V1043 SUPER DARK v1.5 A screen blanker like After Dark from the MAC, there's about 30 blankers.
V1044 FANCY PRINTING DISK Contains Banner, Graph Paper v1.2 and Disk Print v3.59.
V1045 UDRAW v1.0 Provides a mechanism for the rapid drawing of schematic diagrams. Bitmap oriented
V1046 THE XI RAVE SAMPLES Garrett Watt's IFF 808 State samples
V1048 HAM-8 VISTAS (2) Collection of Ham-8 Vista drawings
V1051 EASY CALC v1.0 A spread sheet designed to be both easy to use and fast. Built in excellent help system.
V1054 ADVANCED UTILS 2 Compress Disk doubles the capacity of your D on the fly with compressions. Also DiskOptimizer, SCSI Mount and more.
V1055 PARSEN All the software you need to hookup 2 Amiga's or CDTV's
V1056 DEVELOPER Contains the official Commodore developers Kit for the Amiga Guide & install utilities.
V1057 EDPLAYER Music MOD player that looks, acts & plays like a CD
V1058 3D GRAPHICS Several 3d modelling/ray tracing programs
V1059 GRAPHICS Create stunning graphical images. MPoth creates swirling galaxy images. Roses, Rosyade
V1060 CIRCUIT BOARD DESIGN Includes mCAD v1.26 and several terrific routines for the electronic enthusiast!
V1061 DISK UTILS Several highly recommended programs for performing

- file hard drive backup, file recovery, disk track recovery, and forced disk validation
V1062 DESKTOP PUB Transfers Macintosh screen fonts. AFM metric files to Amiga fonts/PPAGE metric files.
V1063 RIPPERS, STRIPPERS & BEATS For the music enthusiast, designed to strip music from your favorite games.
V1067 3D OBJECTS 3 About 20 objects in Sculpt / TurboSculpt format
V1069 PRINTER DRIVERS 5 Desktop 550c, 500, 500c, Ricoh HP1200, Canon B1300, 130, LP8, 10e, P101800 HP PaintJet
V1070 (AGA) UTILS 2 256 colour icon editor, Plasma256, QuickGrab v1.1
V1071 (AGA) MSM v1.8 Martins system monitor for programmers
V1072 (AGA) WINBLENDER v39.28 Create excellent/stunning AGA fractals. Also contains 68030/040/PPU versions.
V1073 FT-X ACCOUNTS v2.01 Was written as there are not ready any other good account packages.
V1074 (AGA) UTILS 3 Collection of AGA Based utilities. Includes Kill AGA Which allows you to run old badly written programs including demos & some games
V1077 GENEALOGIST v3.04 is a specialized database for keeping track of genealogical information. Full featured & a wide selection of features to use.
V1078 PC TASK v2.03 Software IBM-PC emulator. It allows you to run the majority of PC software with no additional hardware. Now supports VGA, EGA, CGA and MDA. This is a demonstration version.
V1079 KEYBOARD TRAINER v1.1 Best Public Domain Typing Tutor. An excellent New program / Amiga
V1081 REPAIR-IT 3 Contains a selection of Disk, Hard Drive repairing and file saving utilities for the Amiga.
V1083 CROSS v5.1 is a program that creates crossword puzzles for you
V1084 SPECTRUM EMULATOR v1.6 (2) This is the best & latest version of the most popular emulator for the Amiga. There is an 020/030 versions now on the disk which enhance the games on disk.
V1087 STOCK ANALYST is a technical analysis and securities tracking program which calculates when to buy and sell shares.
V1088 WB 2.0+ UTILS Contains ChkRag, DFCS, FastDos, Formatter, No-Click, UnDelete, KeyMac, MegaWB, MR 1 Plane, Open, ResumeMaker & StarBlank.
V1089 STRATAM Recoverable RAM based on VDD but 5 times faster.
V1090 ANSYS (AGA) UTILS Another selection of utilities for A1200 owners also includes FakeMem, KILAGA, AGATest, Degrador and much more.
V1091 ASTRONOMY v2.0 A menu driven astronomy program that calculates information about the Sun, Moon, Planets and Constellations. Help Disk.
V1092 HEROQUEST AID Will aid solo AD&D players who do not have a Dungeon master at the present time. It takes over the DM's role. Good or what.
V1093 PARNET SET-UP (2) A two way network file system between two parallel ports, establish via two amigas
V1095 DEGRADERS If you have trouble running software on an A1200 or A4000/030/040 give this disk a try it will emulate the basic 1.3 rom better than any other software on the Amiga at present.
V1096 MING SHU CHINESE ASTROLOGY Will create a horoscope in seconds not hours, the complete aid.
V1097 TITANIC CHEATS v1.40 Contains 950k of raw data which is just a whisker under 600 Games. This presented
V1101 RJ UTILS This disk contains helpful image processing and painting programs. Like Perfect Paint v1.34, Image Workshop v1.3, an IFF Manipulator.
V1102 DT UTILS Contains Border for WB v2.04+ machines, MakeKickFile, Skick v3.34, is a replacement for kick-it, 2 Kick and Kick locks. It will softlock any other version of kickstart into rom.
V1103 TEK-ATAK MODULES An excellent helping of wonderful music for your own productions or to listen to.
V1104 COLOURED ICONS Transfer your disks into colourful well presented works of art with this database.
V1105 VIEW TOOLS Contains Convert, ViewFree, a Family tree easy to use database program, ViewPhone, an British telephone storage database. ViewDisk, is a small disk catalogue utility.
V1106 MAJOR LEAGUE Allows you to keep track of your favorite teams and there results. Doindex v2.4
V1107 BLITZ BASIC2 Comprises of a fully integrated editor/compiler environment for the serious Amiga programmer
V1109 STAR VIEW is designed to show graphically the positions of the stars and planets from any point on Earth.
V1110 ROFCASTER v2.01b is a

- Horse Racing prediction program which uses statistical analysis of Major factors.
V1112 CHEQUE BOOK v2.5 Record your bank and other transactions.
V1114 PRINT LABELS DocDump2.1, Envelope Print v1.2, Inlay Maker v1.4, MC master v1.1, Banner Press, Label Print v3.5
V1116 POOLS WIZARD JNR Dead-activated Amiga Football Pools predictor.
V1117 X-BEAT v1.2 A good program for drum sequencing 16 bass.
V1119 MUSIC BASE v1.0 A versatile a east to use musical database.
V1121 SHAYERA'S TOOLS Contains IFF2RAW, MatchRun, NoClick, PlayMelon, SetStar, TrackPlayer v1.92
V1123 DIGITAL DREAMS UTILS Contains Trax, ProMax, Trax Map, Titans cruncher, Protect, VC, Scramble II, Boot Block Champ II and File Protect.
V1124 FIRST ALERT VIRUS BootK, EVN v2.22, LVD v1.75, MVK v2.2, No Soddam, SnapShot, VC, Virus X, Virus Z.
V1125 LEMMINGS 2 INSTALL This disk will install Lemmings 2 to your hard drive. 1Mb Chip RAM + 512k RAM
V1129 RED DRAW TRVIA The ultimate Quiz and answers game.
V1130 COMMUNICATE v1.2 A helping tool for learning one of the eight formats of communications or languages
V1131 COPPIERS UNLIMITED AContains DCopy, FastEm, FastLighting, Maverick, Mirror, Nib, Rattle, Row, Sanity, Super Duper and Tetrapoxy.
V1133 NUMPAD v37.3 Emulates a numeric keypad on some Amiga Keys.
V1134 TOOLMANAGER v2.1 (2) Includes the ability to add menus to your Tools menu. add WB icons or Windows.
V1136 DISK UTILS 2 Copy, C A disk tool for making backup copies, form-attng ect. DiskSalv v2.0 Disk repair, salvage and undelete util. HDClick, a hard disk menu & workbench tool.
V1137 (AGA) UTILS 4 AGATest, BBlank, CheckAGA, CycloMenu, DoubleX, Force VGA, GIF Datatype, PKLudge, PPSHOW, Rend24, ViewTex & Verout
V1138 (AGA) UTILS 5 Degrador, Pow-Ray, AmigaToDouble, ComMemLast, Palette, Promotor, RomTagMem.
V1139 (AGA) UTILS 6 A4091Patch, Alert Timer, Bestid, Clouds, Hamd JPEG, NewPOP, NISCANTISC, PatchPointer, Plasma PCX Data type & Screen Mode changer.
AMIGA GAMES
V1073 TETRIS ORIGINAL This is the closest game to the original tetris.
V1420 OTRIS If you want an or 2 player Tetris this has to be 1 of them.
V1749 SCRAMBLE 'The Original' Remember that old classic game from the arcades when to buy and sell shares.
V1977 POM POM GUNNER Shoot down world war II or planes in this Operation Wolf
V2018 JETMAN Spectrum classic converted to the amiga with all the original sounds.
V2022 SEA LANCE The first Silent Service type sub war game on PD
V2054 ATIC ATAC A rendition of the game from the original Spectrum.
V2164 DUNGEON ON NADROJ This is the best D&D adventure type game. Load WB
V2220 STRATEGIC GAMES (Eternal Rome, Lords of Hosts, In Moonshine)
V2221 MIND GAMES 21 of the best games to challenge your mind.
V2272 BLACK JACK LAB Play all the popular versions of Portolan
V2278 CARD SHARP A professionally presented selection of solitaire games.
V2280 DIPLOMACY Classic strategy game loosely based on World War 1. 2Mb
V2411 TOTAL WAR Strategy world conquest type game. 1 or more players
V2432 GOLDEN OLDIES Golaga, Golaxion, Space Invaders, Asteroids, Batly & Missile Command
V2447 CONDROP Fruit Machines simulator with various gamble modes.
V2448 CRAZY SUE Another first rate cute school girl platform game.
V2480 FRUIT MACHINE 2 As near as poss to the Arcade machines
V2485 IRON CLADS Updated Strategic War Game which is heavy on your mind (2)
V2491 LEGEND OF LOTHIAN v1.02 An excellent adventure game in the vein of Ultima.
V2498 AMOS CROCKET is an excellent arcade cricket simulator with nice graphics.
V2514 TETRIS is a 1 or 2 player Tetris game. The 2 player game is Head 2 Head.
V2617 GOLDEN OLDIES 2: Crook, is a 1 or 2 player Frogger. BIPones is 1 of the most addictive games we have played here. Trail-Blazer, as the C64 Classic, Scumble Shootemup.
V2620 DR MARIO You must move coloured pills down the screen. 3 in a row go's
V2621 ETERNAL ROME Start the Roman Empire from 32BC. Build fleets, armies & attack
V2622 DONKEY KONG Original platform game in which you must rescue the girl.
V2676 MORIA v5.4 Loads of new features, better graphics, larger dungeons, screen updates, overview of dungeon's map
V2710 CLASH OF THE EMPIRES (2) v2.1 Strategic War Game by T.A.Sear
V2724 NEIGHBOURS This is the best graphical adventure game to date (2)
V2738 AIR TRAFFIC CONTROL Try to guide upto 100 planes into the AirPort
V2775 ROULETTE ROYAL Why not do some gamble with chips at the casino
V2802 CARD-O-RAMA Sea heaven, Crib Klondike, Black-jack, Scissors, Street
V2825 ALL ROUNDER A Cricket simulation with great graphics & play
V2842 CRAZY SUE II Sequel to the all time best selling PD platform game.
V2854 SPACE INVADERS II A revised old classic Space Invaders game.
V2863 FIGHTING WARRIORS A karate combat fighting contest game.

- V2932 NUMERIC Enjoy puzzles / Tetris then this is a must. You have a scorable board & you must place letters blocks to get points.
V2941 EXTREME VIOLENCE Scrolls around much bigger than Smash TV
V2987 BOMB JACKY A conversion as the original Bomb Jacks, it's as the best yet
V2988 BALDERS GROVE It's here Boulder dash with a selection of levels that work fully.
V3023 UCHESS (AGA) Do you love chess then try this. 4Mb & WB 3.0
V3037 55W is a game for 2 based on Space Wars but with many extra features.
V3038 TANK HUNTER A 2 player Tank Attack game with various levels
V3039 ASTEROIDS II v0.85 This is the best version of Asteroids I have ever seen, if you like Asteroids games then this is for you.
V3040 TETRIS (AGA) If you like tetris, you need this disk. AGA graphics.
V3075 18 HOLE GOLF (2) The first excellent golf game. Select speed & power
V3162 SON OF BLAGGER This is a classic 164/Spectrum platform conversion Can you remember how active it is to play
V3214 UNYCONQ A strategy game where two human players battle for control of the universe. Status information is continually updated to allow the player to concentrate on strategy. Includes digitized pictures and sound.
V3234 SYSTEM DEFENDER If Defender is the name of the game then this is the game for you. In free defender style it returns all features.
V3235 ALFIN BASH The game is set in a prison for the galaxies mentally unstable. You have been imprisoned there along with a bunch of your mates. Rescue your friends by shooting.
V3237 SMOODG Racing game in which you skip around a nice track and win the race.
V3252 BONDIMINE II Well produced game in the vein of the classic Boulder Dash games.
V3253 OPERATION METEOR This game is set in 3d graphics in which you must travel around trapped in this graphic stunning adventure.
V3257 SUITCASE (2) The best adventure on the amiga to date. Excellent
V3265 WIBLE WORLD GIGGY Wibble World of Gogga Maria his town Jew can enjoy the joys of controlling an egg shaped character for free. Solve puzzles avoid the monsters
V3269 BRANBOW is an original board game, which will have you taking your brains for hours. Rather like a version of the pie-up Scrabble with a new rule change. When the game commences you will see a normal baseball pitch & players positioned as in baseball.
V3283 NECESSARY ROUGHNESS (2) Puts you in charge of a team of your choice and lets you play a computer team, again of your choice. As headcoach you will have to call the play that you think will be most effective to the game. You will then be able to see the action, followed by a brief summary of what you have just seen.
V3285 THE ENTITY v1.1 You play the role of I should say control the stix and you're being invaded by the Entity. You are enclosed in an electrified which must not be touch.
V3286 AIR HOCKEY is a bot and ball game based on air hockey from the amusement arcades its a basic game for 2 players.
V3287 ROAD TO HELL (2Mb) is an overhead view driving game like HoRad and super sprint. It requires skill and coordination for success. The aim of the aim of the game is to win the gold in the Championship by making more money than your opponent. There's a helping extra which can be bought from the shop like enhanced types, Better Engines, Rockets, Snake screens ect.
V3310 STAIRBASE 13 (2) is a graphical adventure, similar in style to monkey island or Operation Stealth. The controls and what they do are fairly obvious.
STAR TREK + SF-II
V3305 ATOS KILGONN D77 CRUISER fires torpedoes while passing by MCC-1844
V3306 ATIC ENTERPRISES Leaves the Star station disk. NCC 1701-A classic original
V3307 AT22 APPROACHING VESSELS
V3308 AT23 STAR TREK FLEET MANUEVER
V3309 AT33 THE PROBE II & BRID OF PIRCY
V3310 AT34 LEAVING SPACE OFFICE Docking, Attack mode, Bird of Prey Scout attacking.
V3311 1060 STAR TREK v1. TNG Game
V3312 1081 ULTIMATE STAR TREK (2) Game by Tobias Richter. Now in English
V3313 2222 STAR TREK TNG This is the latest quiz game based on the T.N.G (2)
V3314 2501 STARTRK / Jimbo Barber (2) 2add
V3315 2503 STARTRK Eric Gustafson (3) 2add
V3316 2926 STAR TREK THEMES! (2) The original sampled version of the Star Trek themes.
V3317 2879 CULT TV (2) This volume features 6 more cult shows from the 60's & early 70s include complete Episode Guides, Indepth background guides, seasons listings, cast, Credits
V3318 3106 STAR TREK DEEP SPACE 9 SLIDES
Star Trek / Wars Video Tape
25Min long Tobias Richter 24bit ray traced animation which took 6 weeks to produce. (VHS Format) £11.99
Code Numbers
Works with Workbench 2.0
Works with Workbench 3.0
Not A600 Machines
Not A500 or A600 Machines
Not Workbench 3.0
Requires ?? Amount of disks
??Mb Requires ?? Amount of memory
NEW DEMOS
V3366 SOME DEMO / LEANON
V3338 AQUARIUM MEGA DEMO
V3354 FAIRLIGHT RAVE DEMO
V3290 GRAPVINE 16 (3) £4.00
V3212 IGAJI NIGHT BREED SLIDES (2)
V3136 KEFREN'S DESERT DREAM (2)
V3139 SCOOPER 7 UNLIMITED (2)
V3063 IGAJI HOCS MEGA DEMO
V2921 STATE OF THE ARTS
V2815 LAWRPOWER MAN (2)
V2818 JESUS ON TS / USD (2)
ACCESSORIES
MOUSE PAD £3.49
DUST COVERS £4.49
A500 A500 A600 A600 A600
A1200 £4.99
LC10 LC10 LC24-10
3.5 DISK CLEANING KIT £3.49
DISK LABELS 3p Each / Min 50 or
(E)1.99 for 1000. Which Includes P&P
DISK BOXES £4.00 £5.49 £8.99
CATALOGUE 1Mb 2Mb+
DISKS (3) £2.50
PRICES ARE PER DISK
1...DISK £3.00
2-5...DISKS £2.75
6-10...DISKS £2.50
11-20...DISKS £2.00
21-50...DISKS £1.75
51+...DISKS £1.50

PD-Soft Font Disk 05 PD-Soft Font Disk 06
Cluster Cocin Columbus Crillee
COMARO CRACKLINGFIRE COOLTOLOGY
CooperHighLight COTTONTWOOD
DaisyDancing BSBank Curveform CSOVAL
Daytona
Debussy BEVANRA DickensBald
Dickens Deiglight

NEW! CD4: Aminet CDROM Just For 1993 (£24.99 + £1.00 P&P) Released!
The Aminet CDROM contains thousands of Amiga programs from the Aminet Internet Archive. This disc contains nearly 600 megabytes of software. The thousands of applications include GNU programs such as the GNU ANSI C/C++ compiler, the GDB symbolic debugger, GNU Emacs, the Ghostscript previewer, and GNU Chess. There is a huge selection of sound files, and utilities to play them, including Noisetracker and MED modules. This disc contains hundreds of games, including educational games, video and arcade games, strategy games, war games, card games, and word games. The disc contains many modern communication programs and BBS software.
The Aminet CDROM is in ISO-9960 format, so you can read this disc from nearly any system, including Amiga and IBM PC. BBS index files are included for popular MSDOS BBS's. This disc is brand new in 1993. Also contains Workbench 2 and Workbench 3 sections. Full of software & shareware.

Your Name Address Post Code Telephone Card Card No Signature
A/c No
I enclose cheque/PO for £

Fred Fish has recently announced that he will be soon moving his noted PD collection on to CD. Richard Baguley spoke to the man himself to find out why...

PD Special

IF YOU WERE to look in the adverts of any PD company, one name would pop up consistently. That name would be Fred Fish. Since the birth of the Amiga in late 1985, he's been producing what many people regard as the best collection of PD programs available for the Amiga. So why did he start the library?

"I didn't really start it with the intention of it being a long-term thing," says Fred. "I just wanted to collect together a few utilities I had and make them available to everybody else, and it just kind of grew from there."

Since then, he's released over 900 disks, averaging around 15 a month. Fred explains how he chooses a program: "Probably around 25 to 50 per cent of the stuff submitted to me makes it to the floppy distribution. When I look at a program, I have to decide if

Address	Type	Pri	OpenC	Version	Neg	Pos	Name
07c00154	library	0	16	37.3	204	44	utility.library
07c03698	library	0	1	37.35	824	424	graphics.library
07c06270	library	0	1	37.2	48	158	keymap.library
07c076e0	library	0	1	37.7	200	70	layers.library
07c0ad74	library	0	1	37.318	764	3294	intuition.library
07c0e400	library	0	39	37.44	1832	996	dos.library
07c3a2f0	library	0	0	37.67	24	44	version.library
07c3d874	library	0	4	37.11	164	50	icon.library
07c48f30	library	0	0	39.3	56	134	diskfont.library
07c49550	library	0	1	37.1	272	46	iffparse.library
07c4db68	library	0	0	10.3	584	92	dopus.library
07cae9ac	library	0	2	37.132	188	2061	workbench.library
07c37330	library	0	4	37.27	200	66	commodities.library
07c37420	library	0	6	37.110	168	226	gadtools.library
07c025e0	library	0	1	37.1	96	60	mathieedoubbas.librar
07c0241c	library	0	2	36.23	476	252	reoxsyslib.library
07c46c9c	library	0	2	35.347	132	48	powerpacker.library
07c4d5e0	library	0	0	2.8	96	78	inovanusic.library

Recent Fred Fish disks have contained such useful programs as ARTM, a fearfully useful program which will tell you exactly what's lurking in the innards of your Amiga (assuming you don't know).

be for the new material submitted that month. Hopefully there will be enough overlap [between disks] to enable users to buy every other disk and still get all of the new material. Once I get to floppy disk 1,000, there will also be a CD available containing all of the disks in the library."

So how much will the CDs cost? "\$20, but I'm only going to produce as many as people order, so if people want a particular CD-ROM, they will have to pre-order it. There will be a few extra copies available for people who haven't pre-ordered, and these will cost \$30."

The compilation CD-ROM of the first 1,000 disks should be available in February, and will also cost \$20 if you order it in advance.

Obviously, you will need a CD-ROM drive in order to access these discs, but you could use a CDTV connected via ParNet (featured on last month's Subscriber Superdisk - see Page 168 for details) to another machine, or get hold of a cheap SCSI CD-ROM drive if you have a SCSI equipped machine. Many Bulletin Boards now have CD-ROM drives attached, and you should be able to download the software from these.

people will find it useful and if it's good enough quality. There are also space constraints, but this should be less of a problem when I'm on to CD."

Fred does a lot of juggling compiling 15 disks a month, so he's decided to switch over to producing the library on CD-ROM.

"When I reach disk 1,000 I won't be doing any more floppies. It'll be purely on CD-ROM. The first CD should be ready for release in early October. There will be a monthly CD that has all the new material for that month."

This will be released in two forms: an archived format suitable for use with a BBS and a ready-to-run format. Several tools such as compilers and text readers will also be included every month. But how much new material will each disk include?

"There should be a couple of hundred megabytes of tools, utilities and stuff like that," Fred explains. "The remaining part of the disk will

CONTACTING FRED FISH

Fred Fish's CD-ROM discs can be ordered from:

FRED FISH
 Amiga Library disks
 1835 East Belmont Drive
 Tempe, Arizona 85284 USA

Or you can leave E-Mail at this number:
 E-Mail : FNF@FISHPOND.CYGNUS.COM

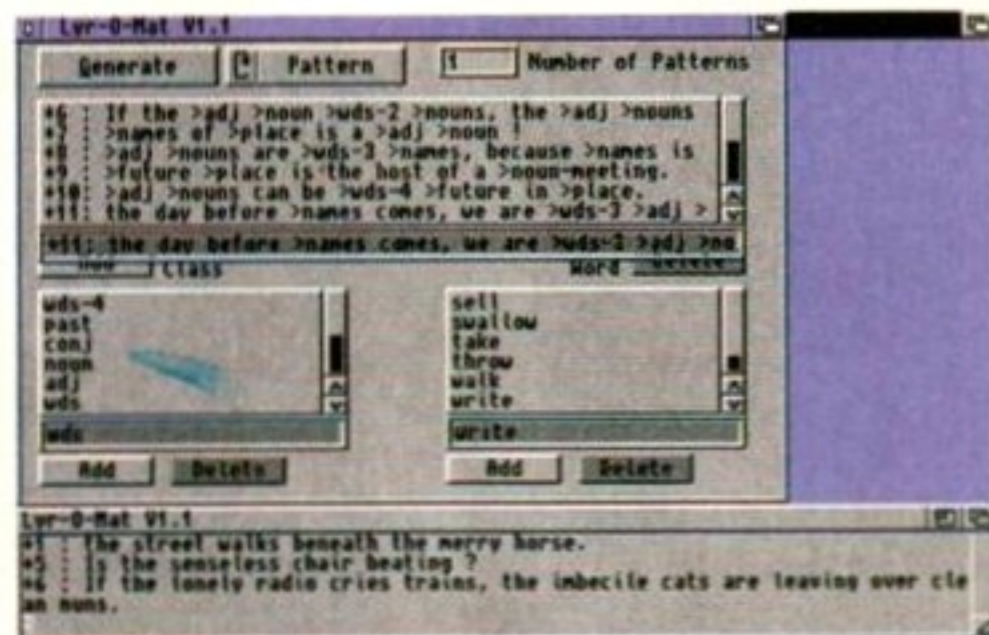

A recent Fish offering was the very silly Lyr-O-Mat, which generates random sentences. Highly amusing!

SUBSCRIBERS GET IT EVERY MONTH

AF Subscriber Superdisk
 A special collection for subscribers only

- ARTM - Monitor your Amiga in real time
- Buzzbar - Excellent Blitz Basic game
- Dropbox - Kicks off programs from a file icon*
- Harrington - Classic Compugraphic font
- False - Small but perfectly formed programming language
- Lyr - O - Mat - Computerized sentence producer*
- FhSpread - Fully featured spreadsheet
- NewList - Superb file listing utility
- PowerSnap - Cut and paste from any screen*
- Startup - Alter your start-up preferences*
- Lazybench - Workbench menu utility
- * Workbench 2 or greater required for these programs

This month's Subscriber Superdisk contains 10 excellent programs, and one font. Most of the programs are from Fred Fish disks 880 to 890. There's also a copy of the excellent Blitz Basic game Buzzbar, and an excellent art deco font called Harrington. See Page 168 now for details on how to subscribe and receive your free Superdisk and monthly newsletter!

PUBLIC DOMAIN JARGON BUSTED

The world of Public Domain is full of confusing terms and names. Here Amiga Format aims to demystify this world, with a guide to common PD terms and names.

PUBLIC DOMAIN - Any software which is in the Public Domain (PD) can be copied and distributed by anybody, as long as no money beyond the cost of providing the disk changes hands, though not necessarily as little as £2, as we said last month (include mail order and staff costs, and many libraries have to charge a little more). There are PD companies that advertise in Amiga Format, so read through the adverts. You are also allowed to make copies of PD disks and distribute them to friends yourself, again as long as you don't make a profit.

SHAREWARE - This means that the freely distributable version on the disk is disabled in some way, and the full version can be obtained by

sending a small sum to the software's author. Some people distribute the full version, but with the proviso that if you use the program regularly, you should send them a small registration fee. There's no way for the author to force you to do this, but you are morally (and legally) obliged.

LICENCEWARE - Somewhere between PD and commercial programs, in that you are not allowed to distribute it, but it doesn't cost very much. A Licenceware disk will cost you under a fiver, but as a rule the quality of the programs are much higher than many Public Domain programs.

FREWARE - Totally unrestricted, copyable PD.

NEW TITLES

- +3410 LOCK PICK 2^W WOW!
This program comes supplied with a list of over 400 of the latest games available and can remove password protection, disk copy protection or simply copy original as seen. This is the ultimate backup tool. Get it now...
- +3411 TITANIC CHEATS^A Over 4 hundred cheats for games
- +3139 STARWARS II^A 2 meg anim
A re-vamp of a Tobias anim
- +3140 BATTLE OF BRITAIN^A anims
- +3141 WRASE 1.31^A
- +3142-2 RED SECTOR "time zone"
- +3144 CDTV MUSIC MEMO^A
- +3145 SPACEOUT II^A MUSIC
- +3146 ERK THE WARRIOR^A
Very similar to Gauntlet.
- +3147 FURMYRE^A shoot 'em up
- +3148 TOGGLE CLICK⁺⁺
Stops your drive clicking on A600 & the new Amiga 1200
- +3150 TOOLS FANTASIA^A
- +3155 X-KOPIA v6.5^A disk copier
Quite possibly the most powerful PD copier available, features various copy-modes (not in English)
- +3412-4 QUALITY Time 5meg 4disks
- 3416 KILL AGA V2^{AA} latest version
- +3417 BAD FORMAT^A hides bad tracks on floppy disks so you can still use the disks
- 3418 NFA A1200 TOOLS^{AA}
- 3419-2 FIT CHICKS^{AA} (2 disks)
excellent collection of gilly pictures for A1200 only
- +3334-2 Scenery Animator anim^A 2d
- +3336 FRASCAP V1.0^A
- +3337 RPG ADVENTURE creator^A
- +3339 AMIGA BEGINNERS guide^A
- +3340 CASH FRUIT^A
- +3342 Escape from a very large cave^A
- +3345 CASTLE NOMBS^A
- +3346 AMOS PRO UPDATE 1.12^A
- +3129-3 NEW BATMAN Anim^A 3 disks
- +3152 CRAZZE GLOO^A 3 part anim
- +3155-5 DUNCS Back^A 5 disks (4meg)
- +3138 LIBERATOR GAME^A
Great shoot 'em up action
- +3151 TEST ENGINE V4.0^A
- +3153 WB3 SCREENS^{AA}
- +3155 X-KOPIA V6.5^A
- +3156 WORLD GEOGRAPHY^A
- +3159-2 QL EMULATOR 2 disks^A
- +3161 SLEEPLESS NIGHTS 3^{AA}
A collection of utilities that work on the new A1200
- +3162 "WORLD OF COMMODORE"^{AA}
An amazing piece of coding, WOW
- +3164 Extreme VIOLENCE game^A
- +3165 RAGING HORMONE II^A

RED SECTOR DEMO MAKER
FOR THE A1200 & A500+ with 2 Meg
Create stunning demo's/mega demos with this extremely powerful demo maker, make professional looking intros for your disk. It's easy to use & it's PD
Order ref: **3360**

JUST IN

- +3535 DICE COMPILER^A
- +3539 SUPER DARK^A Over 30 different screen blankers, similar to After dark on the Mac/PC
- +3548 TECHNOPOBIA MUSIC^A
- +3549 LSD TOOLS 112^A
Inc STD CODE type in the code and the town name will come up
- +3550 LSD TOOLS 113^A
INC SAFE II Brilliant new disk copier, Very easy to use. Features around 10 different copy modes
- +3552 LSD TOOLS 116^A
ARESTURE 2.03 Undelete files
- +3553 LSD TOOLS 119^A
Inc E & Random Quoter every time you boot your hard disk a different message comes up
- +3554 LSD TOOLS 120^A
Run Lame AGA & PCTASK 2.03
- +3555 TALENT MEGA DEMO^A
3556 PANTARHEI (AGA)^{AA}
Amazing new A1200 mega demo
- +3557 SPACE INVASION^A fast new version of space invaders
- +3559 POOLS WIZARD JNR^A
- +3560 KIDS DISK 2^A Includes 3 new Kiddies games, featuring a great kids music maker
- +3562 MUSIC BASE UTILITY^A
Store your record/video collection, on floppy disks so you can still use the disks
- +3563 ROAD TO HELL GAME^A
Very very addictive new top view race game for up to 2 players
- +3564 SPECCY EMULATOR 1.7^A
- +3565 MUGSY HIRED HOOD^A
- +3566-2 HIS MASTERS NOISE^A
Contains heaps of music tracks
- +3568 Quick grab 1.1 & screens 2.1^A
- +3569 MICRO MARKET GAME^A
Run the stock market, from your own home, and without losing any money.
- +3570 RUMMY^A the card game
- +3571 WILLY WORM^A up to date snake game
- +3572 SIMON^A Remember Simon Says,

PRINTERS

- Electronic game. This is it.
- +3350 STAR PRINTER DRIVERS^A
A collection of printer drivers for the range of Star printers including 9 & 24 pin mono/colour & Bubblejet
 - +3351 PANASONIC DRIVERS^A
Supports 9 pin & 24 pin printers
 - +3421 PROFESSIONAL DRIVERS^A
A selection of printer drivers for the more professional user, ie: Laser, HP etc like all our driver disks, easy to install.
 - +3352 CITIZEN DRIVERS^A
Enhance the quality of your print with the drivers on this disk
 - +3353 CANON DRIVERS^A
Essentially for the BJ series of Canon printers, including the new BJ10xx & the classic BJ10xx
 - +3408 HP550C PRINTER DRIVER^A
At last a driver for the HP550C
 - +3409 SEIKOSHA DRIVERS^A
For 9 pin & 24 pin printers
 - +3390 HP PRINTER DRIVERS^A
A miscellaneous collection of HP drivers, including the 500 & 500c
 - +3033 DYNAMITE DRIVERS^A
A huge collection of nearly 100 different drivers, if you've got a weird printer you'll most likely find a weird driver to match on this disk.

JUST IN
PANTA RHEI AGA
Brand new A1200 only mega demo
Contains Amazing graphics & colours, fast paced. Not to be missed
Order ref: **3356**

A1200/A4000

- WHEN ORDERING ASK FOR AN A1200 PD LIST**
- 3432 ACTION REPLAY MKIV
Rip graphics, sound, music, give yourself infinite lives, change the game graphics freeze your game and save it out, and more
 - 3428 ANDY'S WB3 UTILS
Probably the best A1200 compilation
 - 3288 A1200 VIRUS KILLERS
Virus protection without infection
 - 3433 PC TASK V2 (AGA) run PC VGA software on your Amiga, needs MSDOS, available separately @ £3.50
 - 3422 RETINA BURN A1200 version
Lovely rave demo for A1200... wow
 - 3467 PPSHOW30A display AGA
Powerpacked pictures
 - 3465-2 SPECTRUM Emulator 10.6
Very fast A1200 speccy emulator, includes a few old speccy classics
 - 3429 PLASMA CLOUDS 256 lovely plasma effects in glorious 256 colours
 - 3500 HDMEM make your computer use your hard disk as virtual memory, if you've got an 80meg HD have 80ram. Requires FPU, MMU etc
 - TEAMHIOS 2 AGA MEGADEMO
Fantastic new AGA mega demo... wow!

31/2" DISKS
A box of 10 branded diskettes for only
£4.95*
*With any purchase of PD disks

NEW TITLES

- +3086 VIEW 3.2 (ANIM PLAYER)^A
Well up to date anim player, even plays HAME
- +3087-2 JESUS ON ES (2 disks)
WOW factor of 10, over 20 mins
- +3088-3 THE AD (3 disk anim) (3 meg)
- +3093-2 Sounds of Science (2 disks)^{AA}
- +3094-2 ROAD HOG (2 disks)^{AA}
- +3095-2 TOTAL CHAOS Music (2D)
- +3096 BADBOYZ AGA an disk 1^{AA}
- +3106 MIX ONE EP^A
- +3107-2 FEEL LISTEN CARE EP^A
- +3111 OUTERIM (Melenium 2.2)^A
- +3112 ADDRESS PRENT v3^A Useful address printing utility
- +3114-2 UNLIMITED "get ready"^{AA}
- +3116 ZINGER GAME^A
- +3117 Tales of a time traveler^{AA} disk 1
3 megabyte comical animation
- +3195 WITLE^A (ascii transferer)^{AA}
- +3196 VIRUS V2.2^{AA}
- +3197 ABACKUP V2.0^{AA}
- 3198 NTSC/PAL SWITCHER⁺⁺
- +3200 BOOT JOB^A
- +3203 THRUST^A
- +3205 BOOTX 5.23⁺⁺
- +3206 MORIA V5.4^A
- +3207 ASSORTED UTILITIES^A
- 3208 VIEWTEK V1.02^{AA}
- 3209 WB3 RAINBOW^{AA}
- +3210 NEWPOP^A
- 3211-5 Weird Science (5 disks)^{AA}
- 3216-9 AGA IMAGES (9 disks)^{AA}
- 3225-6 Super HAM PICS (6 DISKS)^{AA}
- +3231 TRONI-CAD
- +3261-5 HINTS & CHEATS^A 5 disks
- +3266 FAST INTRO MAKER V1.0^A
- +3267 GIGA-TETRIS^A
Polished Tetris clone
- +3268 IRON CLADS^A DISK A
- +3269 IRON CLADS^A DISK B
- +3270 RE-ORG V2.53^A
- 3271 GIF DATATYPE^{AA} (WB3)
Put in workbench 3 Datatypes.
- +3272 DIGITAL ILLUSIONS V1.0^A
- +3273 SAMPLE FACTORY VOL.1^A
- +3122 ATOMAS^A Weird game
- +3123 PAY ADVANCE ANALYSER^A
Useful program for keeping track of pay, tax, & NI.
- +3125 T.A.C.K. V1.2
The Animation Construction Kit
- +3128 MATCH STICK MAN^A
- +3200 NEW AMOS GAMES^A
- +3292 Ultimate Cheats & solutions^A
- 3294 MAGIC MENU^{AA}
- +3297 A.C.E.S. DATABASE V2^A
- +3298 GRAMMAR CHECKER^A
- +3299 CLUB MIX 3
- 3300 ACTION REPLAY for A600
- 3304 WB3 HACKS^{AA}
- +3308 AMOS FRUIT MACHINE II^A
- +3309 ASI MULTIVISION^A
- +3310 CLUEDO^A
- +3311 FILE-O-FAX
- +3322 TOP OF THE LEAGUE^A
- +3324 ASTEROIDS 92^A
- +3326 CHINESE CHECKERS
- +3329 ABASE V1.33 (BILL)
- +3391-2 ADOVE FONTS^A
- +3393 CG FONTS^A
- +3394 JOYSTICK TESTER^A
- +3395 INTERACTIVE dance trash^A
- +3396 SANTY JESTERDAY^A
- +3397 JELLY "global chaos"^{AA}
rave demo, great music.
- +3398 HEADLINE "black energy"^{AA}
- +3399 FREESTYLE "PERFECT 5"^A
- +3400 COMPLEX "DELIRIUM"^A
- +3401 PIECE O MIND^A
- +3402 Andromeda "point break"^{AA}
- 3403 MORE WB3 HACKS^{AA}
- +3404 CHILDREN'S favourites^A
Nursery rhymes for children
- 3405 WINBLENDER^{AA}
- +3407 EXCEL DATABASE^A
- +3408 HP550C PRINTER DRIVER^A
- +3455 GNU CHESS^A
- +3456 FRUIT PANIC^A Pacman clone with a difference
- +3457 VECTOR STORM^A Beil new Tempest clone, very fast...
- +3458 ARTILLERUS^A
- +3459 BAGITMAN^A Excellent Platform game
- +3460 AZTEC CHALLENGE^A
A blast from the past
- +3461 MEGABALL 2.1^A

UTILITIES

- +3336 FRASCAP V1.0^A
Create with ease Vista type backdrops
- +3346 Amos Pro update v1.12^A
Upgrade your Amos Pro so you can use the Amos compiler and Amos 3D
- +3311 FILE-O-FAX^A Sort your life
- +3309 ASI MULTIVISION^A A huge collection of very useful graphics tools, including rippers
- +3301 BETTER BENCH^A New WB replacement
- +3288 A1200 VIRUS KILLERS^{AA}
A selection of virus killer that work on the new A1200
- 3295 SYS INFO 3.11 FOR A1200
Test the performance of your new A1200 or A4000
- 2994 FREE COPY 1.8^A
- 2879 ATARI ST EMULATOR (++)
- 0699-4 ESSENTIAL UTILITIES
A four disk collection of essential tools, including Virus killers, directory tools, text editors, bootblock tools etc

UTILITIES

- +3434 NCOMM V3^A communications
- 3435 DEWWARE JPEG UTILS^{AA}
A Collection of Jpeg utilities
- +3516 BLOAD RUNNER^A a classic
- +3517 PATIENCE^A the card game
- +3517 PATIENCE^A the card game
- +3520 REBOUND^A futuristic bat & ball
- +3522 ACCOUNT MASTER
- +3523-3 AMATEUR RADIO^{AA} 3 disks
- +3526 COLOUR AIRCRAFT ART^A
- +3527 REVELATIONS^A
Outstanding hand drawn pictures, includes a few naughty pictures, but they're fantastic!
- +3528 POST + PS FONTS^A
- 3530 QUICK GRAB AGA^{AA} rip Jpeg PCX, GIF pictures & save them as IFF
- +3552 GAME TAMER 4.01^A cheats!!
- +3553 FONT FARM 3^A 50 great fonts
- +3558 ERROR INFO V2^A gives you a list of all Amiga error codes & their meanings

A1200 PUBLIC DOMAIN
If you own an Amiga 1200 or A4000 ask for our A1200 PD list, it gives details of all our AGA PD software, we have over seventy A1200 PD disks including demo's, a few games, and loads of tools
A1200 PD LIST

UTILITIES

- +1547 ADVENTURE WRITER^A
- +2919 RE-ORG2^A
A powerful hard disk optimizer
- +2927 MULTIDOS 1.12^A
Great file transfer
- +3155 X-KOPIA^A
- +2409 205 UTILITIES (++)
A huge collection of 205 utilities WOW
- +3151 TEXT ENGINE 4^A
- +3272 DIGITAL ILLUSIONS V1.0^A
- +1999 AMIGA FOX DTP^A
- +1938 600 BUSINESS LETTERS^A
A collection of 600 pre-written business letters
- +3236 V-MORPH^A
Complete Morphing package
- +2420 NCOMM V2.0^A
Very popular Comms package
- +2635 ESSENTIAL UTILITIES 4
- +2897 KICK STAR2 EMULATOR
- 3148 TOGGLE CLICK FOR A1200
- +2699 EDWORD V2.2
A very competitive word processor
- +2698 VIDEO EDITORS KIT
- +2701 SHOWGIF & IFFGIF
- 3255 VIEWTEK 1.03^{AA}
An essential purchase for you to display the A1200 AGA graphics
- +2700 SURFACE PLOT^A
- +3258-2 LYUPUNOVIA (2 disks)^{AA}
- +3347 EXTERMINA^A

WORKBENCH

- WB1.3 WORKBENCH 1.3 £3.50
Replacement workbench for the A500
- WB2.04 WORKBENCH 2.04 £3.50
Replacement copy of WB for A500+
- WB2.05 WORKBENCH 2.05 £3.50
Replacement for A600
- WB3.00 WORKBENCH 3.00 £3.50
Replacement for the new A1200
All WB disks are subject to availability

ACTION REPLAY 4
An Amiga 1200 title only
Allows you to rip graphics, give yourself infinite lives, rip music and sound fx, freeze your game, save your position & more.
Only £3.00. Order ref: **3432**

CLIP ART

- ART1-2 WEDDINGS (2 disks)
- ART14 ANIMALS
- ART24 WACKY
- ART26-2 BANNERS (2 disks)
- ART34-2 TEDDY BEARS (2 disks)
- ART22 SEA LIFE
- ART9 OFFICE
- ART7-2 KIDS (2 disks)
- ART76-2 PREHISTORIC (2 disks)

JUST IN...

- 3501 TEAM HOIS AGA DEMO 2^{AA}
Fantastic new AGA only demo features some really amazing 256 colour plasma effects...shows off the A1200
- +3494 MAVERICK COPIER^A
Another new parameter copier, removes protection from various games
- +3496 IFF BOOT^A displays a picture whilst your hard disk boots up, a bit like the PC Windows package does
- +3357-2 KEFRENS Desert Dreams^A
Fantastic new demo by Kefrens (2 disks)
- +3359 SANTY INTERFERENCE^A
- 3360 NEW RSI DEMO MAKER^A
Modified disk, so it now works on A500+ & A1200 the best demo maker available
- +3361 THE GATHERING GFX^A
Amazing hand drawn pictures
- +3367 AMIGA EA V2.1
New programming language
- +3372 ADDRESS PRINT 3.1^A
- 3375 DOS DRIVERS (++)
Kickstart 1.3 & Kickstart 3 on disk...
- +3376 ASTRO 22 V3^A
- +3377 NEW SOLITAIRE^A
Great new shareware card game by Tower Software. Love it
- +3382 LSD LEGAL TOOLS #9^A
Superb collection of utilities
- +3431 TECHNOLOGICAL death^A
If you liked Spaceballs you'll love this it's a really great new mega demo. WOW

UTILITIES

- +3434 NCOMM V3^A communications
- 3435 DEWWARE JPEG UTILS^{AA}
A Collection of Jpeg utilities
- +3516 BLOAD RUNNER^A a classic
- +3517 PATIENCE^A the card game
- +3517 PATIENCE^A the card game
- +3520 REBOUND^A futuristic bat & ball
- +3522 ACCOUNT MASTER
- +3523-3 AMATEUR RADIO^{AA} 3 disks
- +3526 COLOUR AIRCRAFT ART^A
- +3527 REVELATIONS^A
Outstanding hand drawn pictures, includes a few naughty pictures, but they're fantastic!
- +3528 POST + PS FONTS^A
- 3530 QUICK GRAB AGA^{AA} rip Jpeg PCX, GIF pictures & save them as IFF
- +3552 GAME TAMER 4.01^A cheats!!
- +3553 FONT FARM 3^A 50 great fonts
- +3558 ERROR INFO V2^A gives you a list of all Amiga error codes & their meanings

A1200 PUBLIC DOMAIN
If you own an Amiga 1200 or A4000 ask for our A1200 PD list, it gives details of all our AGA PD software, we have over seventy A1200 PD disks including demo's, a few games, and loads of tools
A1200 PD LIST

Latest & Greatest

- +3155 X-KOPIA V6.5^A
- +3410 LOCK PICK 2 is a fantastic new disk copier that can actually remove any games. Over 400 games listed
- +2997 IBM EMULATOR WB2
- +3310 CLUEDO^A
- +3032 FANCY DISK LABLER
- +3046 WONDERLAND
- +3058 SPACEBALLS⁺⁺
- +3194 ENGINEERS KIT^A
- 3432 ACTION REPLAY IV A1200
- +3090 THE HAUNTED (8 DISKS)^{AA}
- +2934 FREE COPY 1.8^A
- +3434 PC TASK V2 Excellent new PC emulator. If you have an A1200 you can even run PC VGA software
- +2805 THE NBI V2.0 "UPDATE"
- +2968 HELL ZONE
- +3121 NUMPAD FOR A600
- +3199 OCTAMED 4B^A
- 3467 PPSHOW 3.0a Displays AGA powerpacked picture files
- +2524 SUPER POWER PACKERS
- +2474 BANKN & CLERK^A
- +3197 ABACKUP^{AA}
- +2303 KIDS PAINT^A
- +2361 TYPING TUTOR^A
- +2357 DISK REPAIRERS
- +2409 205 UTILITIES^A

DIAGNOSTICS

- +3378 AIBB V5^A
- +3295 SYS INFO 3.11^A
- +3194 ENGINEERS KIT^A
- +3257 DISK REPAIRERS^A
- + AMIGA DIAGNOSTICS^{AA}
- +3347 EXTERMINA^{AA} Virus killers
- +3201 UNDELETE^A get back deleted files from your disk
- +3394 JOYSTICK TESTER^A great little joystick testing program

TETRIS GAMES

- TET01 TETREN
- TET02 SUPER TWINTRIS
- TET03 TRITRIS 3 players
- TET04 CLJ-TRIS
- TET05 DIGITAL TETRIS (NEW)
- TET06 A1200 TETRIS (NEW)
- TET07 TETRIS PRO (NEW)
- TET08 GAMEBOY TETRIS
- TET09 LETTRIX
- TET10 KLAKTRIS
- TET11 DIZZY DIAMONDS (NEW)
- TET12 AMIGA COLUMNS
- TET13 GIGA TETRIS for 500+
- TET14 SHAPES
- TET15 TETRIX
- TET16 TETRIS METALICA
- TET17 AVATRIS
- TET18 D-TRIS
- TET19 TETRIS 2 The original
- TET20 SUPER BLOCK OUT
- TET21 WELTRIX
- TET22 DR MARIO Mario Bros ?
- TET23 TETRA COPY
- TET24 COLOURS
- TET25 CLUBS 3D version of Tetris

OK on all Amiga's

A1200

Essential for A1200 owners
A1200 DEGRADERS DISK
Includes:
->FAKE FAST MEM gives you 512k chip memory & 1.5meg fast memory
->THE DEGRADER turns off memory and cpu, drives, caches etc
->RELO KICK 1.5 turns your A1200 into a 500 allows you to run old games
->KILL AGA V2 turns off your AGA chip set to give greater compatibility
->HELPFUL HINTS brief quick start
Instructions Order ref: **3356**
ALL ON ONE DISK @ JUST £3.00
SELF BOOTING DISK. EASY TO USE

WORD FINDER+

- CLU08 Powerful crossword & anagram solver, with a dictionary of over 40,000 words.
2 disk set only **£4.50**

Compatibility Chart

- = Kickstart 1.3
- ++ = Kickstart 1.3 & 2.xx (A500+/A600)
- +++ = Kickstart 2.xx
- AA = also works on Kickstart 3 machines
- AAA = Kickstart 3 machines only (AGA)
- >To ensure full compatibility on A1200 order a copy of Kick 1.3

Priority Order Form (AF)

Name _____
Address _____
Tel: _____
Amiga model _____
Payment method _____
Credit Card No. _____ Exp. _____
Total disks ordered _____ Total price: £ _____
 Catalogue disk available only £1.00

Ordering by Post

Simply tick the boxes of the titles you require, fill in your name & address, remove or photocopy this page and send it to: VIRUS FREE PD, 31 Faringdon Rd, Swindon, Wilts SN1 5AR. Please make cheques or Postal Orders payable to VIRUS FREE.

GAMES

- +3545 CASTLE NOMBS^A Run of the mill Dungeon Master clone
- +2822 THINK TWICE^A Very good mastedmind clone
- +2811 HEMERIODS Brilliant arcade conversion of the Asteroids game
- +3045 MOTHER LOAD^A is the Amiga version of Load Runner
- +3025 SPACE INVADERS II (A)
Great new version of the classic Invaders
- +2884 SUPER QUIZ
- +2900 GRAY SLAYER
- +2820 PETER'S QUEST 20 level platform game
- +3303 SLAMBALL^A football manager
- +3285 VENUS INVADERS^A
Excellent new version of space invaders
- +3531 PREMIERE PICKS^A Great new update of this management game
- +3515 GIDDY^A Very addictive & cute Platform game
- +3518 MONACO^A Race, race, race
- +3519 FRUIT SALAD^A Smart looking platform game. Don't miss it
- +3537 RPG ADVENTURE maker^A
- +3538 SILVER BLADE^A Run of the mill shoot 'em up.
- +3340 CASH FRUIT^A new fruit machine simulator
- +2838 CYBERTEK GAMES Vol. 1
Compilation of games, great
- +3342-2 OLEMPIAD^A (2 disks)
Play Decathlon but with Lemmings
- +2824 MENTAL IMAGE GAMES 1
- +3283 PSYCHO SANTA^A
Take control of a Psychoic santa
- +3808 FRUIT MACHINE II^A
- +2830 BALOONACY^A Bomb blitz type of game
- +2990 BOUNCE N BLAST
Addictive Mario type game
- +3282 ELEVATION^A
Very addictive platform game
- +3281 CAR WARS^A
- +2831 LAME ST PORTS
Atari st game port overs
- +3324 ASTEROIDS 92^A Very nice Asteroids game
- +3280 SPLASH^A Is Battleships
- +2833 SHOOT 'EM UPS Vol 1
Compilation of shoot 'em up's-great of the classic board game
- +2895 DOMINOES
- +3276



United Public Domain

The innovators

THE BEST SELECTION OF PD IN THE UK!

GAMES

PG003 AIR WARRIOR Good flight sim + (not AG00)
 PG006 ANTEP & SLOT CARS role playing game + Y
 PG021 ATIC ATAC Really playable game + Y
 PG023 BATTLEFORCE strategy game!
 PG024 BLACKJACK A good card game + Y
 PG025 BATTLESHIP A really good game + Y
 PG028 COLOSSUS & WORLD Fab adventures I + Y
 PG031 DARKSTAFF Spc emulated text adventure!
 PG032 DRAGONS CAVE D&D style game Mega + Y
 PG034 ETERNAL ROME Strategy & DOMINOES + Y
 PG046 HACK Great text adventure-infocam style + Y
 PG047 HOLLYWOOD TRIVIA Nice Trivia Game!
 PG048 HOLY GRAIL one of the best text adventures + Y
 PG053 LARN A superb game + really good + Y
 PG059 LORE OF CONQUEST space trading D&D game + Y
 PG066 MENTAL IMAGE I Gndrunner invaders & rebound + Y
 PG063 MORIA Classic adventure now version 5.4! + Y
 PG064 NAPOLEONIC WAR SIMULATOR A strategy game!
 PG068 NO MANS LAND H tech war game-shoot arm + Y
 PG070 PETER'S QUEST Rescue the maiden platform!
 PG071 POM GUNNER A beach-head on the 64-y
 PG072 PROPERTY MARKET Become a millionaire!
 PG073 RAPHAE'S REVENGE Turtle game in SEUCK!
 PG074 RETURN TO EARTH Elite space trading game + Y
 PG076 SEVEN TILES Soodetail type game-MEGA!
 PG079 SEALANCE A submarine strategy game + Y
 PG101 THE INSIDERS CLIMB rocks & runs game + Y
 PG121 ASK01 GAMES 21 games to run on a plus + Y
 PG127 AIRMANIA Super platform game from Addware + Y
 PG128 CHEAT WORKS Stacks of new cheats.
 PG129 PUGGLES Brilliant Q'bert game!
 PG131 ATLANTIS A nice looking strategy game!
 PG138 BATTLE OF BRITAIN & WAR strategy game!
 PG139 DUNGEONS OF MADRID Excellent D&D games!
 PG142 KING GAMER A nice looking strategy game!
 PG149 A NIGHT AT THE TOWN WYLLI text adventure!
 PG153 WAR very good strategy/war game + Y
 PG154 NUMPTY & ALIEN INVADERS Manic miner type game!
 PG159 MR BRICK Great mania type collect coins game!
 PG164 GAME TAMER 2.3 joystick tester & 258 cheats!
 PG165 SQUID SQUAD Nice little driving game + Y
 PG167 WHAT'S IN A NAME? A nice puzzle game just in!
 PG174 AMOS CRICKET Shareware cricket game, I or 2pl + Y
 PG175 SPACETRAX 2 player shoot each other up game + Y
 PG178 MENTAL IMAGE 2 Three Excellent new games + Y
 PG180 SECTOR 1 A nice game similar to Alien Breed + Y
 PG182 ETHOS Simple graphical adventure Simbad style + Y
 PG183 CATAOCOMBS small D&D style game -VG.GFX + Y
 PG187 THE INSIDERS Very good Shootem up game + Y
 PG185 ARAZMAM Similar to the game Microbes, Good + Y
 PG190 TRO SECRET An excellent quality platform game!
 PG191 ACT OF WAR New space strategy game + Y
 PG194 INTRUDER ALERT Very good strategy game!
 PG199 CASHFRUIT Nice fruit machine game + Y
 PG200 ALL ROUNDER CRICKET New cricket game + Y
 PG202/278 CLADS Good strategic war game!(2) + Y
 PG205 SOCCER CLADS Good strategic war game!(2) + Y
 PG218/9 CLASH OF THE EMPIRES Super strategy + Y
 PG226 3D GAMES 3 games done in 3d construction + Y
 PG247 PICTURE TILES Nice picture puzzle game + Y
 PG255 KINGDOM AT WAR Nice strategy war game + Y
 PG256 LCD DREAMS 4 small LCD games + Y
 PG257 THRON CUNTS Very good Shootem up game + Y
 PG258 AGA TETRIS 1200 A nice game Mega + Y
 PG259 PICTURE PUZZLE Solve picture jigsaws + Y
 PG260/1 18TH HOLE A nice golf game! (2) + Y
 PG262 AGA CHESS Needs aid of ram to play! AGA ONLY.
 PG264 SIBILLAIRE SAMPLER Nice new game! + Y
 PG265 WOLFBLE WORLD GIDDY Fab platform game + Y
 PG266 BOX ADVENTURE Nice shareware adventure + Y
 PG267 SLAMBAZ Muzic/Matematic Management sim + Y
 PG268 SLIDE SQUARES Nice sliding puzzles + Y
 PG269 GUSH This is a pipeline type game + Y
 PG270 THEY CAME FROM OUTER SPACE invaders + Y
 PG272 MAYHEM Money multiplier manic maze game + Y
 PG273 MUGSIE Money making gangster adventure + Y
 PG274 ROULETTE & PUNTO 2 nice games (not 1.3) + Y
 PG275 GAMER'S GAMER A nice strategy game!
 PG276 SKIDMARKS Amazing driving game, very fast + Y
 PG277 ZOMBIE APOCALYPSE & DEFENDER 2 fab games + Y
 PG278 BILLY BURGLAR Just try & escape the spotlight + Y
 PG279/80 OLYMPIAD 2 disk Lemming olympic events(2) + Y
 PG281 CAVEFLIGHT Simple dodges the obstacles game + Y

ASSASSINS GAMES PACKS!

The best selection of PD games ever assembled anywhere now all autoboot on A1200! (though not all games will run) Something for everyone!

AS1 1 Tanx, Rollerpede, Avtris Amigods etc!
 AS2 Invaders,Bally 2.Missile command etc!
 AS3 Megaball & Orip Superb gamepack + Y
 AS4 Frogger Go Moku, Cracker, Jumpy etc!
 AS5 Raid, Go Loopy & Super Invaders + Y
 AS6 Pacman, Donkey Kong, Wario, etc!
 AS7 Moonbase, Tru, Nightwings, Clauderunner + Y
 AS8 Airacs2,Hball,Snakepit & Numberfumbler + Y
 AS9 Features Battle pong & Blizzard + Y
 AS10 Escape, Pipeline, Pickers & Sys!
 AS11 Dad, Connex,Revers, Towers & Trappin + Y
 AS12 Llamator, Car, Powerpong, KFI, Fab!
 AS13 Tetris, Squabble,Block, etc!
 AS14 Chinachallenged & Amiga Columns + Y
 AS15 Battacears Letrix & Mambamovny!
 AS16 Wastelands, Mission X,Dellemna,Paclan + Y
 AS17 Tomcat, Defenda, Jetman,Bugblaster + Y
 AS18 Henry in Panic Skyflier Omega race! + Y
 AS19 Zentru,Francis,Freddy,Spokane & more! NOT800
 AS20 Microbes, Hollywood, Wario, Goin drop + Y
 AS21 Zeus, Tetrix, Battlemites & Dragonflies + Y
 AS22 Lemming, Wizzys,quest Duel Mouthman + Y
 AS23 Quick money,BIP, Interstar Arcadia + Y
 AS24 Revenge of camels,Duo Croak,3dmaze etc!
 AS25 Mr Brick,Copper,hermerods,E Type + Y
 AS26 Superpacman 92,Smastiv, Ashido System 4etc + Y
 AS27 IMPLODER V4.0, Megastruck, Ubi + Y
 AS28 Doodly, Dr.Mario, Invaders2, Dambomber2 + Y
 AS29 DooG, Rome, Nova, B-Bal, Atax, Quadrix + Y
 AS30 Bouce & Blast, Total Fire Tank attack + Y
 AS31 Arazm, Crazy pipe, revolution etc! + Y
 AS32 Blob, Sector one & Firefighter + Y
 AS33 Hyperball & War! 2 good games + Y
 AS34 Trailblazer, Yop, Obc, Rushour! + Y
 AS35 Pong,Snakepit,Cybernetix Jump n roll + Y
 AS36 Mother lode, Wonderland, Kong Tactix + Y
 AS37 Klaktris, Ghostship, Paccer etc!
 AS38 One on One,Baldy,Skyflier2,Transplant! + Y
 AS39 Lots of card games on this disk! + Y
 AS40 Disk full of sidling puzzle games + Y
 AS41 Pacman deluxe, Extrax, Helizon Lead bit etc!
 AS42 Galaga, Intuder, alien, Dogs in space!
 AS43 Interlock, Roulette, Octohello etc!
 AS44 Nibble, Mouse Impossible, Roti on etc!
 AS45 Drix, Pacchese, B-Castle, Tetraser etc!
 AS46 Amiga Q, City,Checkers, Ouch etc! + Y
 AS47 Elevation, Furryrye,Crave,Arenal + Y
 AS48 Point to point,Psycho ballia etc!
 AS49 Deathbringer in space Sue 1+2 etc!
 AS50 Euphorion,Roach Motel,Balders grovel + Y
 AS51 Lammers, Fighting Worm,Shapes! + Y
 AS52 Rockslide, Mouthman, & Nul + Y
 AS53 Venus Invaders,Mastermind etc! + Y
 AS54 Serene,Serene II & Car Wars! + Y
 AS55 Cl-tris, Pacatca & Asteroid! + Y
 AS56 Steameagle, Extra, Helizon & Ties! + Y
 AS57 Pong,900 Dominicos,Dizzy Diagnostics,Squirm + Y
 AS58 Super raid 4 Magnatron & Maissae! + Y
 AS59 Turbo truck GX200 & Leadings! + Y
 AS60 Pipe master2, Alien Hunter & Checkers! + Y
 AS61 Rattlesnake Running Chaser,Scud blaster + Y
 AS62 Pipelines2, Mazeman & Up and Down 1 + Y
 AS63 Nautilus, Friends & Drive, Get it + Y
 AS64 Oblivion,tab, Breakout con kit etc!
 AS65 Paranoids Chess Word Puzzle Word search + Y
 AS66 Cow wars,Asmstermind & Askobani + Y

AS1 67 Siege of the Beast,E Type II & Vektor! + Y
 AS1 68 Demolition, Mission, Boulder & Atoms! + Y
 AS1 69 Klondike, Cassio, Apollo, Bridge etc!
 AS1 70 Dizon, Tetrix, Wario & Tetris pro! + Y
 AS1 71 Numerix, Battlehips & Vs Tanks! + Y
 AS1 72 Escape prc, Boulderdash(not 1200) Carli + Y
 AS1 73 Levex, Concentration & Challenger + Y
 AS1 74 Crazy pipes II, Bombacky & Chute! + Y
 AS1 75 Double-squares Colours & Diamond thar! + Y
 AS1 76 Gnu Chess, Cubus & Gerb! + Y
 AS1 77 Balloonix, Cliffhanger & Descender! + Y
 AS1 78 Little Boulder, Headgames Fruit Panci! + Y
 AS1 79 Gray Attack, Vector Storm & Atom! + Y
 AS1 80 Army Miner Flip it, Goll The Gallows etc + Y
 AS1 81 Amos Defence, Thunder Tron & Gergardun + Y
 AS1 82 Artilever, Shuttle run & Arcade Volleyball + Y
 AS1 83 Loadsamoney, Pong & Spider(cards) + Y
 AS1 84 Nigma, Aklash & Zerkel! + Y
 AS1 85 Paradox pro, Matchcards, Rubik & Baghtman! + Y
 AS1 86 Smurfunt,Lords of Host,Legend of Lofthian + Y
 AS1 87 Aztec Challenge,Jonus Fullstrand & Landmines + Y
 AS1 88 Defender, Relayar & Mosai! + Y
 AS1 89 Megaball 2.1, X fire and Claudio! + Y
 AS1 90 Flashboy, Startans & Minefield! + Y
 AS1 91 Rotter, Madok & Tetris, Tetris, Tetris + Y
 AS1 92 Bil, Obidox, Solitaire, Samplir + Y
 AS1 93 Smash bang wallop, Mr Munk & Alien bash! + Y
 AS1 94 Super skoda challenge,Merchomad & Giddy! + Y
 AS1 95 Premier pics,Tangle,loop & Flop & Super league man + Y
 AS1 96 Dungeon Flipper,Backgammon, Tumble tots rastebrake + Y
 AS1 97 Burnbyest,Mutants from Mars, New stubb city + Y
 AS1 98 Sychase The Phone company & Healer cards! + Y
 AS1 99 Grib, Paraneumot, Space Wars & Org! + Y
 AS1 100 Bloodrunner, Patience & Monaco! + Y
 AS1 101 Meltdown, Paragon Boomerang & Rothello! + Y
 AS1 102 Fruit Salad, Rebound & Pacsim! + Y
 AS1 103 The Lost Occort, Wacky wabbit & Megaracer! + Y
 AS1 104 Wooden Ball, Operation meisor & Pork a pork! + Y
 AS1 105 Partic, Trian, Gumball, Desert defender + Y
 AS1 106 Ratchet, Concomitids II, Wink worm & Micro market! + Y
 AS1 107 Serene III, 4 row 3D Equilog & Yacht C! + Y
 AS1 108 Strikeball, Ringwar, Four in a row & Obesse! + Y
 AS1 109 Poppy blast,King High,Deluxe hawburg Thralbound + Y
 AS1 110 Space rescue,Trix Zerg & Huskerul + Y
 AS1 111 Karate Worm II, Stax & Billy Dragon! + Y
 AS1 112 Thunder II, Aliens Tron & Ship 2! + Y
 AS1 113 White rabbits, Concomitids II, Wink worm & Poppye! + Y
 AS1 114 International Cricket pre,Insectoids II & Yum yum! + Y
 AS1 115 Star trek shoot up,Egyptian run, Sime time & Shark! + Y

Assassins game packs made up in only numbers you require: or AS1 1-35 only 33.95 inc P&P!!!

FENPACK GAMES PACK 1-35 only 33.95 inc P&P!!!

most run on Amiga 2.0

EDUCATION

PE001/5 EDUCATION SET science programs for ages 11+ + Y
 PE006 KIDSPANT Fab title talking colouring book + Y
 PE007/8 LEARN & PLAY Maths, spelling etc 5-10 yrs + Y
 PE009 STORYLAND 2 Save toyland from the witch! + Y
 PE010 TOTAL CONCEPTS ASTROMOMY Book on disk + Y
 PE011 TOTAL CONCEPTS DINOSAURS Book on a disk + Y
 PE013 SIMON & SPACE MATHS Talking maths program
 PE014 SPANISH, FRENCH, GERMAN TUTOR-Not 800!
 PE015 TREASURE SEARCH! Find the lost treasure! + Y
 PE016 COLOUR FOR ALPHABET Learn letters & colours! + Y
 PE018 TYPING TUTOR, Superpsl Budget & Macalender + Y
 PE019 DUNKS DTP A sort of DeskTopPublisher for kids + Y
 PE020 MATHS DRILL Good maths disk for the young! + Y
 PE021/4 SCIENCE Very good four disk set! (4) + Y
 PE025 FRACTIONS & SILHOUETTES Good maths tutor + Y
 PE026 WW II FACTS Good historical program + Y
 PE027 MEGA BEGINS FOOTBALL Learn to use your machine + Y
 PE028 MATHS ADVENTURE Solve questions to progress + Y
 PE030 DESKTOP GUIDE TO ELECTRONIC MUSIC! + Y
 PE033 MATCH WITH HUMPTY Match the objects! + Y
 PE034 WORLD GEOGRAPHY Quite useful disk! + Y
 PE035 KIDS DISK1 Super to learn reading! + Y
 PE036 FIREWORKS ALPHABET Good for kids! + Y
 PE037 HOORAY FOR ALPHABET Super prety + Y
 PE038 HENRIETTA'S BOOK OF SPELLS Fab prety + Y
 PE039 COLOUR It Excellent little colouring pad! + Y
 PE040 HOW THE EARTH BEGAN The full story! + Y
 PE041 SINGALONG NURSERY RHYMES Good fun! + Y
 PE042 CHILDRENS FAVOURITES More fun! + Y
 PE043 PICTURES & LETTERS For very young 1mg chip + Y
 PE044/5 AMERICAN FOOTBALL Learn the game!(2) + Y
 PE046 TOTAL CONCEPTS DINOS 3 PREVIEW Superb + Y

BUSINESS

BB001 AMICASH bank management program + Y
 BB002/3 ANTBALANCICAL Superb spreadsheet! (2)Y
 BB004 ASI LABEL PRINTERS 3 of the best + Y
 BB005 BANKIN control your cheque book! + Y
 BB006 BUSINESS CARD MAKER Nice program + Y
 BB007 CLERK Complete accounts package + Y
 BB008 DESKTOP PUBLISHER Simple to use + Y
 BB009 FLEXBASE DATABASE Address keeper + Y
 BB011 MAMBA BUSINESS Geometric, Grocery list, Calc
 BB013 QED Simple & effective text ed + Y
 BB014 RIM DATABASE Fully relational! + Y
 BB015 TEXTPLUS V3.00 The BEST Wordprocessor + Y
 BB017 VISICAL SPREADSHEET Simple to use + Y
 BB019 BUSINESS LETTERS contracts, letters + more + Y
 BB020 TEXT ENGINE 4.0 THE LATEST Version!! + Y
 BB021 AMIBASE PRO Powerful easy to use Database + Y
 BB022 FRAMES I/II 3 Latest version of super database + Y
 BB023 FORMS REALLY UNLIMITED form creation prog + Y
 BB024 LAST WILL & TESTAMENTS Just in case! + Y
 BB025 EDWORD Brand new wordpro - V good + Y
 BB026 GRAPH Superb Program graphing data + Y
 BB028 LITTLE OFFICE Integrated Word,Sp,Dbase,Gfx + Y
 BB029 ADDRESS DATABASE Address keeper + Y
 BB030 THE MONEY PROGRAM Home accounting! + Y
 BB031 EASYCALC A superb new Fast spreadsheet! + Y
 BB032 PAY ADVICE Keep record of paystips! + Y
 BB033 A BASE A shareware database program + Y
 BB034 ILINOIS LABELS Super label program + Y
 BB035 BUDGET V1.34 manage personal finances! + Y
 BB036 CHECKBOOK, ACCOUNTING, & Assets! (2) + Y

UTILITIES

(Note: "Y" = ok on A1200!)
 PU002 A.GENE Good genealogy program + Y
 PU004/ab A64 EMULATOR NEW VERSION 2.0 (2) + Y
 PU005 AMATEUR RADIO 1 Interest to radio hams + Y
 PU010 ARP 1.3 Amigods requester system!
 PU012 ASI GRAFTX UTILS graphics converters etc + Y
 PU013 ASI BOOT UTILITIES bootdisk utilities + Y
 PU015 BIORYTHMS, STARCHART 2 Good programs + Y
 PU021 MATHS PROGRAMS, STARCHART 2 Good programs + Y
 PU028 CHEMESTHETICS molecule display + Y
 PU036 CURSOR BASIC COMPILER Just what you need!
 PU037 D-COPY The best PD disk copier + more + Y
 PU039 DBW The fore runner to Skript 3D III + Y
 PU048 DYNAMITE FONTS II Cut'n/Paste fontscreens + Y
 PU049 DYNAMITE FONTS More Cut'n/Paste fonts + Y
 PU055 ELECTROCARD DMMO circuit designer + Y
 PU056 FONTS AND RAM MANAGER Bkg video fonts + Y
 PU059 FONTS & SURFACES Backdrops & fonts + Y
 PU062 GRAPHICS UTILITIES Various misc programs + Y
 PU063 HAMLAB PRO V2.0B/Convert VGA PC/HFF/HAM + Y
 PU064 HARDDRIVE UTILS MRBackup & FixDisk & more + Y
 PU065 ICONMANIA Program icons & more! + Y
 PU066 ICONNIX Cramm packed with icons! + Y
 PU067 IMPLODER V4.0 Megastruck, Ubi + Y
 PU069 JAZZBENCH Alternativ Wb for 1/2/3 users.
 PU071 JR COMM 1.02 Modem users comms package + Y
 PU072 METALLION UTILS Font Editors & more! + Y
 PU073/76 KING JAMES BIBLE Old/New testaments (4) + Y
 PU078 M-CAD Hres design package, Excellent + Y
 PU080 MESSY-SD 2 Read/Write PC Files, Brilliant + Y
 PU083 MORSE PROCODER DMMO for the radio hams + Y
 PU086/7 NORTH C 1.3 (2) Complete C compiler & libs + Y
 PU089 NORTH C 1.3 This is the packed 1 disk version + Y
 PU095 PRINTER DRIVER GENERATOR & new drivers + Y
 PU097 PRINT STUDIO V1.25 Prints pics & text etc + Y
 PU108 ROT A simple 3D drawing package Very popular + Y

PU109/10 (2 disk) Structured clipart for Ppage + Y
 PU111/2 SUPERKILLERS FOR NOTHING Video Utills+Fonts + Y
 PU113 ST EMULATOR Run Amiga software on drives
 PU117/22 SOMETHINGS Virus Killers! You need this!
 PU121/2 TV GRAPHICS DPMnt backdrop+Fonts+(2) + Y
 PU124 ULTIMATE ICONS Iconmaster Iconlab + Y
 PU125 ULTRAPANT v3 A nice paint package!
 PU129/30 VIDEO APPLICATIONS Video utilities + Y
 PU136 ZX SPECTRUM EMULATOR Now with sound + Y
 PU139 GRAPHICS CONVERTERS Mega's Mega's Converter
 PU140 LITTLEBENCH Fab copier & utills Down only
 PU143 OPTIUTILS I Crammed full! Get it + Y
 PU144 OPTIUTILS 2 Get this disk too! + Y
 PU149 ELECTRONIC PROTOTYPY Verboard designer + Y
 PU152/66 CLIPART SET: 15 Disks of the BEST clipart + Y
 PU167 MULTI-PLOT Superb data plotting program! + Y
 PU169 GELIGNITE FONTS Cut'n/Paste fonts!
 PU172 WORDPOWER Solve Amiga's software 12 drives
 PU174 ASTRO 22 professional astrology now V3.0! + Y
 PU175 GELIGNITE FONTS II Excellent! IFF fonts!
 PU176 GELIGNITE FONTS III More of above!
 PU177/8 BENCHMASTER Windowsbench & Messysid!
 PU180 RICHARD SMEDLEY COMP Vat Checker + more.
 PU182 STOCK ANALYST Technical analysis program + Y
 PU183 AMYGEN EDITOR Text editor for Amiga + Y
 PU184 PROCALC V1.0 Professional calculator
 PU185/8 COSMOPOLITAN FONTS (4) Packed with fonts + Y
 PU189 TRONIK VIRUS KILLERS 21 virus killers & docs!
 PU191 LANBUILDER fractal land generator + Y
 PU192 SID 2 Get this! directory utill MEGA + Y
 PU197 MOBED 2 Dpaint for Sprites & 2.1 + Y
 PU198 WORDPOWER Master & Hacky Mega's Mega's
 PU200 LITTLEBENCH 1.3 Now for 1.3 owners!
 PU201 MALICE FONTS Excellent tiny fonts for Dpaint! + Y
 PU202 CYCLOS WEIRD Plasmafractal creator! + Y
 PU203 SCOPE 184 utills & clips for Ppage + Y
 PU204 GATOR GRAPHICS Dpaint tutorial disk + Y
 PU205 PC TASK PC Emulator New Version 2 VGA! + Y
 PU207 MUX TSD Compiler, C22 & Software -AMIGA + Y
 PU208 ASI HANDYTOOLS 3 mega compilation of utills + Y
 PU209 FRED FISH CATALOGUE contains FISH 1 - 880 + Y
 PU210 PC PASCAL Latest version of this pascal compiler
 PU211 AMIGA PUNT A horse race predicting program + Y
 PU212 PERM CHECK PLUS A pools predicting prog + Y
 PU213 RATE RATER Another horse racing program! + Y
 PU214 CRYSTAL BALL Superb shareware video titling + Y
 PU215 WALKER DEMO (2) Incredible 2mg demo + Y
 PU216 WALKER DEMO (2) Incredible 2mg demo + Y
 PU217 WALKER DEMO (2) Incredible 2mg demo + Y
 PU218 WALKER DEMO (2) Incredible 2mg demo + Y
 PU219 WALKER DEMO (2) Incredible 2mg demo + Y
 PU220 WALKER DEMO (2) Incredible 2mg demo + Y
 PU221 WALKER DEMO (2) Incredible 2mg demo + Y
 PU222 WALKER DEMO (2) Incredible 2mg demo + Y
 PU223 WALKER DEMO (2) Incredible 2mg demo + Y
 PU224 WALKER DEMO (2) Incredible 2mg demo + Y
 PU225 WALKER DEMO (2) Incredible 2mg demo + Y
 PU226 WALKER DEMO (2) Incredible 2mg demo + Y
 PU227 WALKER DEMO (2) Incredible 2mg demo + Y
 PU228 WALKER DEMO (2) Incredible 2mg demo + Y
 PU229 WALKER DEMO (2) Incredible 2mg demo + Y
 PU230 WALKER DEMO (2) Incredible 2mg demo + Y
 PU231/5 PAGESTREAR FONTS 5 disks super drivers! (5)Y
 PU236/7 SCOPED 1978 Adobe type fonts, 2 disks full + Y
 PU238/9 M.O.R.C. More interesting raster fonts + Y
 PU240 FREECOPIY V1.4 powerful disk copying program!
 PU241 CALORIE BASE useful for people on a diet!
 PU243 ASPICE Circuit analysis program + Y
 PU244 BON APPETIT This is a recipe database program!
 PU245/256 C MANUAL Latest version on 12 disks! (12) + Y
 PU257/61 PAGESTREAR FONTS 2nd set of fonts! + Y
 PU258 RICHARD SMEDLEY C22 & Software -AMIGA + Y
 PU263 LYAPUNOV Fabulous & unusual fractals + Y
 PU264/8 OUTLINE FONTS For Pro page(3) ONLY! + Y
 PU272 GOLF RECORDER Database for golf scores! + Y
 PU273 PC-AMIGA Similar to Messysid, & docs! + Y
 PU274 TRONICAD V1.0 Electronic circuit designer + Y
 PU278 GELIGNITE FONTS IV More of the fonts!
 PU279 V MORPH V1.79 Superb fractal generator + Y
 PU280 POOLS WIZARD Pools prediction software disabled + Y
 PU282 ASI MULTIVISION 2 ImageLab,Wasp & more,super + Y
 PU283 CYCLING MILEAGE RECORDER Useful! + Y
 PU284 DART MACHINE Dart score recorder + Y
 PU285 WORKBENCH 3 BACKGROUNDS, 1200 ONLY!
 PU286 INSCRIPT Program for Video titling + Y
 PU287 NUMPAD Numpad emulator (8000 ONLY)
 PU288 ENGINEERS KIT Text editor for Amiga! + Y
 PU289 AUDIO ANIMATION STUDIO Create your own! + Y
 PU291 1200 WORKBENCH HACKS Useful utill! + Y
 PU292 1200 UTILS! Gif & PCX datatypes etc! MUST!
 PU293/317 25 disks of Ham radio software! (25) + Y
 PU318 POWER UTILS Utills written in C and C++!
 PU319/23 OUTLINE FONTS For Pro page 2.1 or 3(5) + Y
 PU324 WINEMAKER Database for winemakers! + Y
 PU325 EZASM LAZI & ASBK Programmers disk! + Y
 PU326 PLOTTER Plots two dimensional function! + Y
 PU327/8 X BENCH all round replacement! (2) + Y
 PU329 BCFORTRAN77 Programmers development system + Y
 PU330 SLEEPLESS NIGHTS Utills useful for 1200Y
 PU331/43 COLOUR FONTS database (113) + Y
 PU344 EXEL Nice Calc type database program + Y
 PU345 AMOS PRINTER Print screen from within Amos! + Y
 PU346 EXOTIC RIPPER V2.10 Soundtracker Amos! + Y
 PU347 RAVE GENERATOR Plug in a sampler! 1mg chip! + Y
 PU348 SPEED UTILS Fixdisk Headscan Snoop & more! + Y
 PU349 NCCOM V3.00 The latest version comms disk!
 PU350 FLEXBASE DATABASE Address keeper + Y
 PU351 ASI FIX DISK Get other programs running on dos(2) + Y
 PU352 HP 550C & Cannon Bubblejet printer drivers! + Y
 PU353 TAB MASTER MUSIC to Guitar translator prog! + Y
 PU354 ASTRONOMY V2 calculate info on solar system! + Y
 PU355 SUPERDARK Superb & unusual screen blanker! + Y
 PU356 FORTYFAMR Contains 55 large & Small fonts! + Y
 PU357 CANON PRINT STUDIO A must for BJ owners! + Y
 PU358 FRIDGE TEMPLATES A must for Amiga! + Y
 PU359 PRO PAGE HELP DISK Extremely useful disk!
 PU360 WINDBLEND Super effects but 1200 only!
 PU361 XPX COMPRESSION UTILS compression prog! + Y
 PU362 STARVIEW Guess view of star for given time etc! + Y
 PU363 FORCASTER Horse racing prediction program + Y
 PU364 COURSE FORM Simple horse racing prediction!
 PU365 COURSE FORM Simple horse racing prediction!
 PU366 WBC UTILS Full of obscure but useful utills!
 PU367 PE PRINT UTILS Lots of useful labeling prog + Y
 PU368 IMAGEBASE RUNTIME Standalone for CLU27 + Y
 PU369 TV TITLES DEMO Shareware Titling program + Y
 PU370 24 BIT UTILS Rend 24 & more useful utills! + Y
 PU371 AMOS PRINTER ROUTINE For own Amos prog! + Y
 PU372/3 PARNET NETWORKING Amigods! (2) + Y

ANIMATIONS

PA039 ERIC 5 AMY'S WALKER Cute & sexy! 1.5M + Y
 PA040 ERIC 5 BATMAN vs JOKER Very funny! + Y
 PA042 ERIC 5 COVOTE STRIKES BACK 1mg tcol + Y
 PA043 ERIC 5 MORE AEROTONS Very very!!! + Y
 PA045 ERIC 5 STEALTHY II Mig-29 vs Stealthy I + Y
 PA053/4 LIGHT CYCLES (2) Tron animation + Y
 PA060 NEWTONS CRADLE RT animation + Y
 PA065/66 REAL 3D (4) Super of the program!
 PA070 SHUTTLECRAFT 2D shuffles-satellite + Y
 PA072 THE JUGGLER A classic amiga demo! + Y
 PA074 THE WALKER vs The Helicopter - Mega I + Y
 PA075 THE WALKER vs A2000 A classic I + Y
 PA086 FRACTAL ANIMATION full screen low flying anim + Y
 PA091/3 GAS TURBINE, STEAM & PETROL ENGINE (3) + Y
 PA094 AMY JOGS WALKS & SNEEZES by E Schwartz! + Y
 PA095 HOW TO RUN INTO A WALL by Eric Schwartz! + Y
 PA099 ATF AGILITY new ES anim, very witty as usual!
 PA100 TV DOLPHIN CONTEST Check out the new ES anim! + Y
 PA101 DOLPHIN DREAMS Great Dolphin anim! + Y
 PA103/4 KINGFISHER 2 Superb bird animations! + Y
 PA106/7 THE JOURNEY Fab fractal pics & anims(2) + Y
 PA109 SATURN ORBIT Ray traced light around Saturn + Y
 PA118 3 SCHWARTZ Skydive,Soft landing & bomber! + Y
 PA120 NIGHTFLOCK ANIM V2.0 Now with sound! + Y
 PA120 TWO STROKE PETROL ENGINE Super anim! + Y
 PA122/3 THUNDERBIRDS ANIM Nice animation! (2) + Y
 PA124 ANIM COMP 10 mini animations compilation! + Y
 PA126/7 PHOTONIC DREAMS Rooms & Star animations! + Y
 PA131/40 10 disk set Steve Packer anims(1200 ONLY)
 PA141 STIRLING II ENGINE Another fab engine anim! + Y
 PA142 NIGHTFLOCK ANIM FRACTAL FLIGHT Colourful! + Y
 PA143 XMAS ANIMATION Amusing animation! + Y
 PA144 LET ME OUT Amusing dog & slipper animation! + Y

AGATRON(Ok 1200)

AGA01 RED LOTUS Spinning down the road, Fantastic!
 AGA02 JET FIGHTER landing on a runway, basic anim + Y

AGA03 STAR TREK - Shuttle fly past - Great! 1m + Y
 AGA04 KLINGON CRUISER Flying around your screen!
 AGA05 STAR TREK KLINGON fire torpedoes 1m + Y
 AGA06 LOGO, plus a great star wars fly animation + Y
 AGA07 STAR WARS FIGHTER doing loops etc 1m + Y
 AGA08 STAR WARS, a great anim from the movie (CLU) + Y
 AGA09 STAR WARS - Fighter fly by, impressive 1m + Y
 AGA10 STAR TREK - Enterprise in dry dock, Incredible!
 AGA11 TRON - Tank & Deactivator, Good vectors + Y
 AGA12 TRON ANIMATION - Not one of the best!
 AGA13 ROBO 1 A nice ray traced robot waving 1m + Y
 AGA14 STAR TREK Workbee & Reliant, 3 shots + Y
 AGA15 LOTUS CAR, Billiards, & Jet Fighter animations!
 AGA16 STAR TREK Various anims from the star trek game + Y
 AGA17 STAR TREK TWOK animation Short but okay + Y
 AGA18 STAR TREK - Enterprise fly by, Short anim + Y
 AGA19 BOND ANIM - Cooper plus a car, not too amazing + Y
 AGA20 Huey 2 A helicopter leaving a landing pad + Y
 AGA21 ENTERPRISE DOCKING WITH SPACE STATION + Y
 AGA22 ENTERPRISE APPROACHING stunning anim 11m + Y
 AGA23 FLEET MANOEUVRE Stunning animation! 1m + Y
 AGA24 KULI PEN ANIMATION & Ping pong, Great! 1m + Y
 AGA25 THE RUK, a superb car chase 1mg + Y
 AGA26 BOND ANIM - Cooper plus a car, not too amazing + Y
 AGA27 BOOK OPENING Nice anim of a book opening + Y
 AGA28 SHUTTLE & ENTERPRISE Fab anim by Richter + Y
 AGA29 MILLENIUM FALCON The ship being chased -1M + Y
 AGA30 HYPERSPACE animation & Landing animation 1m + Y
 AGA31 POPSCHIE anim rising out of table 1 mg + Y
 AGA32 ENTER - Space probe flying away 1mg + Y
 AGA33 PROBE OFFICE Star trek anim, a little short + Y
 AGA34 SPACE OFFICE Star trek anim, a little short + Y
 AGA35 SPACE PROBE, great anim of probe zooming off + Y
 AGA36 BIRD OF PREY, loop the loop animation 1m + Y
 AGA37 TOBIAS GOES KNACKERS - Check this out! 1m + Y
 AGA38 TOTALLY WICKED! I Shuttle & Enterprise (2 MEG) + Y
 AGA39/51 AGATRON SPECIAL! Yes, a 15 disk anim! + Y
 AGA44/2 AGATRON SPECIAL! Yes, a 15 disk anim! + Y

POWERANIMS

PP01/2 ANTI LEMMINGGS (2) This is Brilliant 2M
 PP003/4 THE MOVING TREATMENT of my squirrel 1.5M + Y
 PP004/7 AUTOMATED LIGHT (4) Battlerate galactical! 3M
 PP008/10 BUZZED (3) Great anim of wasp crashing! 2M
 PP011/12 DATING GAME (2) Very funny! Get it, 3.5M!
 PP014 GULF WAR Another ES production! Good 2M! + Y
 PP018/20 LOST IN SPACE (3) Good cut tv anim! 2M
 PP021/4 LANDING (4) Tobias Richter poweranim 4M!
 PP025/27 STATION AT KHOUH music animation 3mg(3) + Y
 PP028/9 WALKER DEMO (2) Incredible 2mg demo + Y
 PP030/40 (4) THE MOVIES II (4) Hilarious 1-1mg-3mg
 PP044/45 AMY V WALKER II (2) Another witty ES demo 3M
 PP046 SWEET REVENGE Coyote vs Roadrunner 1.1.5mg + Y
 PP050 UNSPORTING Wicked aerotown by Schwartz 2M + Y
 PP051/2 CHARLY CAT Super Swartzlike cartoon! 2mg + Y
 PP053/4 CHARLY CAT AT THE BEACH 2nd fab anim 2mg!
 PP057/9 CHARLY CAT COUNTER A CANARY Fab! 3MG
 PP060/3 CHARLY CAT MOUTHERMIND Great! 3.5MG
 PP064 DUNCAN DUNG BEEBLE Unusual 2mg animation!
 PP065/6 CHARLY CAT SNOWJOKE Latest anim 2mg + Y
 PP067/9 SPEED LIMIT 3mg motorcycle race! + Y (3)
 PP070/1 LEMMINGGS REVENGE Very amusing anim! 2mg + Y
 PP074/6 G.I. SPY 3mg anim from charlie cat author! (3)

main Distributors

not the imitators!



Most CLR titles
ok on A1200!

.. The Central Licenseware Register ..

Most CLR titles
ok on A1200!

Commercial Quality programs at a PD price!

EDUCATIONAL

CLE01 TOTAL CONCEPTS DINOSAURS Learn your family all about the amazing dinosaurs! 2 disks 4.50. +
 CLE02 TOTAL CONCEPTS GEOLOGY Superb book on a disk by Chris Hill, learn all about the rocks! 2 disks 4.50. +
 CLE03 TOTAL CONCEPTS SOLAR SYSTEM A superb illustrated guide to our Solar system! 3 disks 4.99. +
 CLE05 A-CHORD Teaches you all the chords you need to play the guitar, become the next Eric Clapton! 1 disk 3.50. +
 CLE07 TOTAL CONCEPTS FRESHWATER FISHING Learn all about freshwater fishing! Comes on 2 disks 4.50. +
 CLE08 NIGHT SKY Features over 1500 stars, sky can be displayed as seen from anywhere on earth! Excellent! 1 disk 3.50. +
 CLE09 WORDS & LADDERS Good spelling program. 1 disk 3.50. +
 CLE10 BASICALLY AMIGA Extensive guide to Amigados! Very good program for beginners. 3 disks 4.99! +
 CLE11 LET'S LEARN For children of 5-7 years, progress through 5 levels of difficulty. Sums tunes etc. 1 disk 3.50. +
 CLE12 ALPHABET TEACH Simple to understand spelling program for the kids! Shows picture, asks for word. 1 disk 3.50! +
 CLE13 HOME BREW Create your own! 1 disk 3.50. +
 CLE14 TOTAL CONCEPTS ECOLOGY Learn about the most important "ology" in our lives! Superbly illustrated! 3 disks 4.99. +
 CLE15 FAST FRET This is a guitar scales tutor, 1 disk 3.50. +
 CLE16 KINGS & QUEENS A history lesson on all of the Kings & Queens of England since recorded history! 2 disks 4.50. +
 CLE17 THINGAMAJIG An electronic jigsaw with 24 pictures, place the pieces correctly on the screen, by Len Tucker. 1 disk 3.50. +
 CLE18 WORK & PLAY 3 educational programs: CLICK CLOCK learn the time, FUNTIME TABLES maths & GO SHOPPING! 1 disk 3.50. +
 CLE19 PLAY IT SAFE Teaches safety in the home, Help Teddy make your home safe from the beasts! 1 disk 3.50. +
 CLE20 BIG TOP FUN Four program, Word balance, Matchplay, Balloon burst & Seal a grams 1 disk 3.50. +
 CLE21 JIGMANIA Jigsaw solving & construction set! 1 disk 3.50! +
 CLE22 CHESS TEACHER teach chess in a fun way! 1 disk 3.50. +
 CLE23 MIND YOUR LANGUAGE improve speech 1 disk 3.50. +
 CLE24 SPEED READING This program tests your reading speed & helps you improve it! 2 disks 4.50. +
 CLE25 CHORD COACH This is a superb Piano Tutor, learn the chords & hear the Amiga play them! 1 disk 3.50. +
 CLE26 SNAP An educational game for languages. 1 disk 3.50. +
 CLE27 C.A.T.T. This is a superb Tarot reading program! Now you can

read your own! 2 disks 4.50! +
 CLE30 PEG A PICTURE Make a picture from coloured pegs or coloured shapes, great for young kids! 1 disk 3.50. +
 CLE31 UNDERSTANDING AMOS This set will really help you learn how to use Amos! (NEEDS AMOS) 2 disks 4.50. +
 CLE32 SPITFIRE! Superb illustrated book on a disk covering the legendary WWII fighter plane! 2 disks 4.50. +
 CLE33 MESSERSCHMITT BF109 Another superb WWII book on a disk, this time the German Messerschmitt! 2 disks 4.50. +
 CLE34 YOUR FIRST PONY Want to learn to look after & ride a pony? This will learn you all you need to know! 2 disks 4.50. +
 CLE36 THE TIME MACHINE Teaches kids to tell time, 2 disks 4.50. +
 CLE37 DISCOVERY AMERICA Learn all about the colonisation of the United States of America! 1 disk 3.50. +
 CLE38 HOME INVENTIONS First in the quest for knowledge series, this picture book deals with inventions since 1750. 2 disks 4.50. +
 CLE39 MY LITTLE ARTIST Superb colouring book for children, with features for disabled as well! Needs 1mg chip ram. 2 disks 4.50. +
 CLE40 BOREALIS JUNIOR Drawing for young children 1 disk 3.50. +
 CLE41 BASICALLY MEDICINE multimedia encyclopedia 2 disk 4.50. +
 CLE42 COMPOSITION Photograph Tutorial disk. 1 disk 3.50. +
 CLE43 AMOS LANGUAGE QUIZ Helps learn Amos. 1 disk 3.50. +
 CLE44 PORTRAITURE 2nd photo tutorial program. 1 disk 3.50. +
 CLE45 FUN WITH CUBBY 2 Another 7 tab kids games! 1 disk 3.50. +
 CLE46 BASIC HUMAN ANATOMY Good for education 1 disk 3.50. +

UTILITIES

CLU01 VIDEO TITLER Create video titles! 1 disk 3.50! +
 CLU02 FISH INDEXER database for the Fish library! 1 disk 3.50. +
 CLU03 TYPING TUTOR Full typing course. Comes on 1 disk 3.50. +
 CLU04 ALPHAGRAPH for producing Bar & Pie charts etc! 3.50. +
 CLU05 S.A.S. MENU MAKER make your own menu's! 1 disk 3.50. +
 CLU07 PHILO Simple to use database system. 1 disk 3.50. +
 CLU08 WORD FINDER crossword & anagram solver & 2 disks 4.50. +
 CLU09 PLAY & RAVE2 Music module linker, 2 disks 4.50. +
 CLU10 POWER ACCOUNTS account statements, income etc! 3.50. +
 CLU11 CALC V1 very useful spreadsheet program! 1 disk 3.50. +
 CLU12 VIRTUAL WINDOWS Notebook Address book etc! 1 disk 3.50. +
 CLU13 DATOS A powerful database, many features. 1 disk 3.50. +
 CLU14 STOCK CONTROLLER Keep track of stocks! 1 disk 3.50. +
 CLU15 EPOCH VI calendar for Amiga, 1299 yr diary 1 disk 3.50. +
 CLU16 CROSS STITCH good needlework program, 1 disk 3.50. +
 CLU17 LC10 FONTS Nice fonts for Star LC10 printer! 1 disk 3.50. +
 CLU18 LC200 FONTS Fonts for your LC200 printer! 1 disk 3.50. +

CLU19 LC24 FONTS Fonts for your Star 24 pin printer. 1 disk 3.50! +
 CLU20 CANON BJ10. Super Fonts for Cannon Bubblejet! 1 disk 3.50. +
 CLU21 INVOICE MASTER Sort out your invoices! 1 disk 3.50. +
 CLU22 HARD DRIVE MENU Superb hard drive utility! 1 disk 3.50. +
 CLU23 F15 ANIM BRUSHES Needs D paint! 1 disk 3.50. +
 CLU24 RED LOTUS ANIM BRUSHES Needs D Paint 1 disk 3.50. +
 CLU25 STARFIGHTER ANIM BRUSHES Need D Paint 2 disks 4.50. +
 CLU26 STAR VOYAGER ANIM BRUSHES for DPaint 3 disks 4.99. +
 CLU27 IMAGE BASE Simple to use authoring package 1 disk 3.50. +
 CLU28 CREATIVE ADVENTURE TOOLKIT Needs 1mb chip . 3.50. +
 CLU29 G.F.X. Graphics converters, sprite editors etc! 1 disk 3.50. +
 CLU30 DRAW SELECTOR V2 pools prediction program 1 disk 3.50. +
 CLU31 FLOWCHARTER For creation of flowcharts! 1 disk 3.50. +

GAMES

CLG05 TRUCKIN ON Truck management simulation 2 disks 4.50. +
 CLG06 OBLITERATION Super blast em up! (NOT DOS 2) 1 disk 3.50. +
 CLG08 DRAGON TILES Superb version very addictive! 1 disk 3.50. +
 CLG09 MOTOR DUEL great 3d car racing game. 1 disk 3.50. +
 CLG10 FUTURE SHOCK Guide ball through maze! 1 disk 3.50. +
 CLG11 ALL GUNS BLAZING 2 player , overhead view. 1 disk 3.50. +
 CLG12 BULLDOZER BOB Clear screen of blocks! 1 disk 3.50. +
 CLG13 PARADOX Another good puzzle game! 1 disk 3.50. +
 CLG14 SONIC SMARTIEHEAD Crazy platform game! 1 disk 3.50. +
 CLG15 SPLODGE THE ESCAPE puzzle platformer 1 disk 3.50. +
 CLG17 IMBRIUM Excellent graphic adventure! 1 disk 3.50. +
 CLG18 SKAN 29 Guide Sid through 220 levels! 1 disk 3.50. +
 CLG19 STELLAR ESCAPE Vertical shoot em up! 3 disks 4.99. +
 CLG20 JUNGLE BUNGLE Nice adventure game! 1 disk 3.50. +
 CLG21 FLOWER POWER Gro before the bugs eat them! 1 disk 3.50. +
 CLG22 STOCKING FILLERS Seasonal Xmas games! 1 disk 3.50. +
 CLG23 MARVIN THE MARTIAN A maze type game. 1 disk 3.50. +
 CLG24 EASY MONEY fruit machine simulator! (Not dos 2 or 3) 3.50. +
 CLG25 WHITE RABBITS This is a good puzzle game! 1 disk 3.50. +
 CLG26 MONSTER ISLAND Dungeon Master game! 1 disk 3.50. +
 CLG28 TIME RIFT Game played over 4 time zones! 1 disk 3.50. +
 CLG29 BILLY BALL Good 3d isometric game! 1 disk 3.50. +
 CLG30 CAPTAIN K Nice platform game! 1 disk 3.50. +
 CLG31 DIRTY RACKETS 3 tennis games on here! 1.5mg1 disk 3.50. +
 CLG32 7 BLOCKS stop the falling blocks! 1 disk 3.50! +
 CLG33 BAT 'O' ROONS 2 player bat & ball game 1 disk 3.50. +
 CLG34 CYBERNET Sideways scrolling shoot em up 1 disk 3.50. +
 CLG35 OG Prehistoric caveman rescues girlfriend! 1 disk 3.50. +

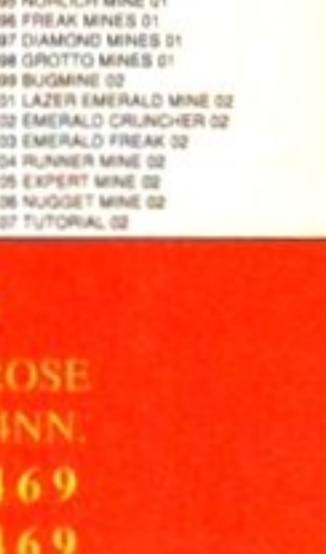
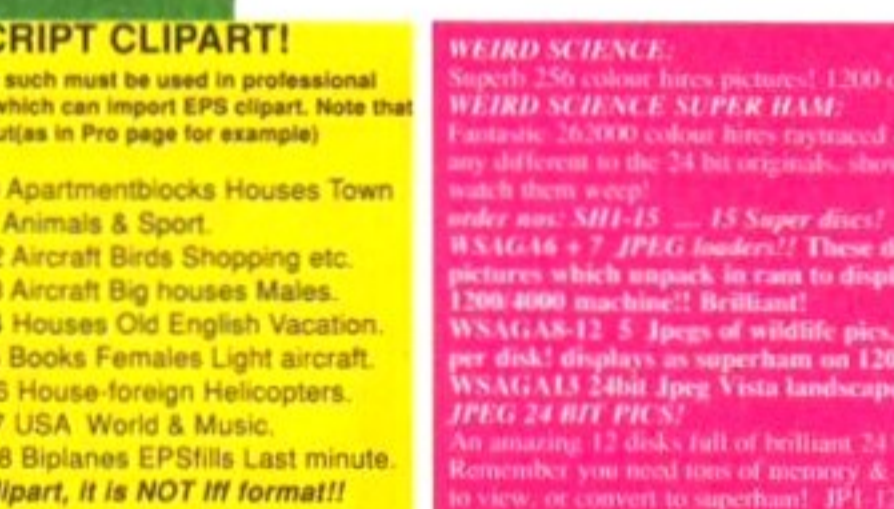
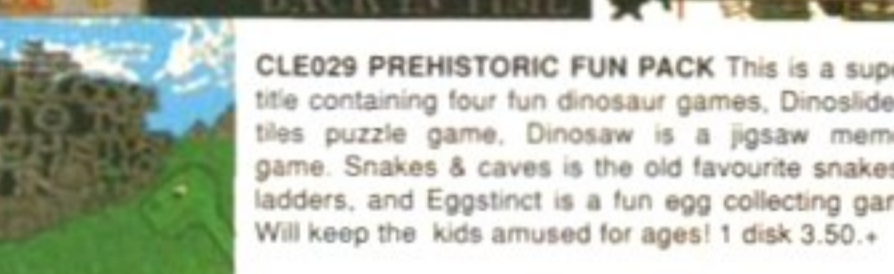
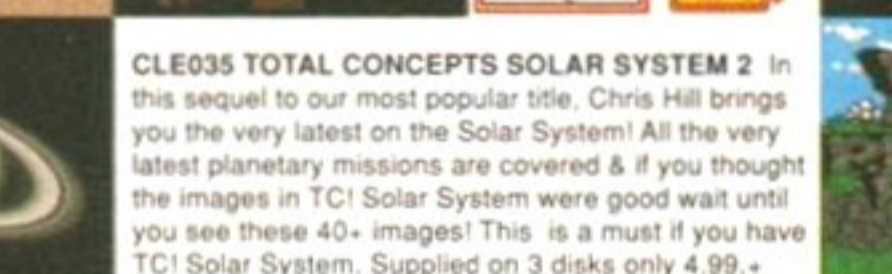
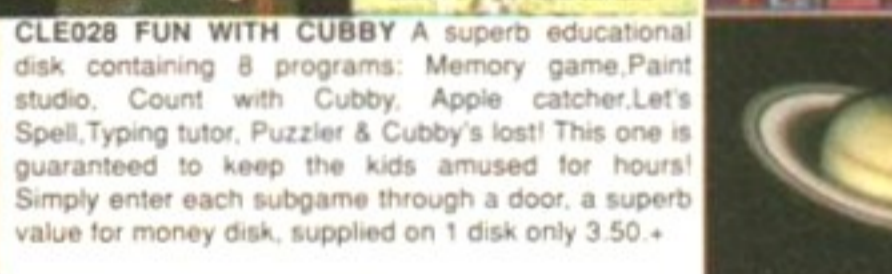
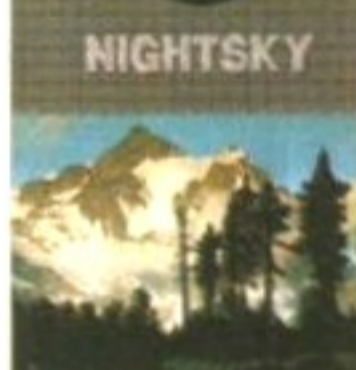

COMPTECH PRO COMMERCIAL CLIPART!
 This is a brand new range of clipart designed exclusively for UPD! These images are of very high quality and detail and are priced at 2.50 per disk! All images are in 16 colours and may be imported into most packages! PC versions available!
 CT001 TRIASSIC DINOSAURS CLIPART The first age of dinosaurs! only 3.50! +
 CT002 JURASSIC DINOSAURS CLIPART 1 Suberb quality clipart! only 3.50! +
 CT003 JURASSIC DINOSAURS CLIPART 2 More superb Jurassic art! only 3.50! +
 CT004 CRETACEOUS DINOSAURS CLIPART 1 This is 1 rex's era! only 3.50! +
 CT005 CRETACEOUS DINOSAURS CLIPART 2 Triceratops, 1 rex etc. only 3.50! +

NEW WEIRD SCIENCE MULTIMEDIA TOOLKIT CD ROM!
 This is a superb CD Rom, filled to the brim with over 10,000 files, 500 24bit jpeg images & 500 Ham & Ham interface versions. Hundreds of megabytes of clipart. (In black & white colour and scaleable). Hundreds of fonts. Compographic fonts & coloured fonts, icons, music modules, music samples and lots more! Includes utilities to view & listen to the files, a front end menu program & slideshows! Superb for multimedia presentations! Works on CDTV, CD32, Amiga CD Rom & is also PC compatible on suitable PC CD Rom! Superb value only 19.95. +50p p&p

ENCAPSULATED POSTSCRIPT CLIPART!
 This superb quality clipart is structured clipart and as such must be used in professional software such as Pagestream. Pro page or any other which can import EPS clipart. Note that you may need a Postscript laser printer to print these outlays in Pro page for example! These disks are all 2.00 EACH!!
 EPS1 Dining pictures.
 EPS2 Medical & Weddings.
 EPS3 Houses clips.
 EPS4 Office & Business.
 EPS5 Children US Insignia Places.
 EPS6 Boats Food Moving.
 EPS7 Buildings Chefs.
 EPS8 Houses-bits Icons.
 EPS9 Kitchen People Groups Holiday.
 Please ensure that you can use this clipart, it is NOT in format!

CLASSIC CLIPART (Black & White)
 (Okay on A1200 / A4000.)
 The clipart in this collection is very high quality, huge bitmaps, many greater than an Amiga hires screen, for use in DTP or DTP packages, each disk contains an A1200 version of the clipart, you can view the clipart by moving the mouse! Prices per disk:
 ART01 WEDDINGS Super wedding clipart, 2 disks! +
 ART02 HOLDS 2 disks, pictures of mansions etc! +
 ART03 RELIGIOUS 3 disks full of holy clipart! +
 ART04 WW2 AIRCRAFT World war II planes! +
 ART05 MEN 2 disks full of men at work! +
 ART06 WOMEN 2 disks full of women clipart! +
 ART07 KIDS 2 disks containing kids clipart! +
 ART08 BUSINESS Disk full of office clipart! +
 ART09 OFFICE Another office type disk! +
 ART10 STUDENTS Lots of student type pics! +
 ART11 SALEITEM Many useful logos etc! +
 ART12 XMAS 3 disks of Xmas related pics! +
 ART13 PUNCH 3 disks of cartoon pics! +
 ART14 ANIMALS Fantastic quality pictures! +
 ART15 CATS Only 12 pics but super quality! +
 ART16 SILHOETTES 18 super silhouettes! +
 ART17 SCHOOLS 2 disks of school pictures! +
 ART18 BABIES Clipart on a baby theme! +
 ART19 MEN 2 disks full of sport pictures! +
 ART20 OLYMPIC Another sport type disk! +
 ART21 MEDICAL 2 disks full of medical clipart! +
 ART22 SEALIFE Pictures from the Ocean! +
 ART23 DECORATIVE MONTHS 1 for every month! +
 ART24 WACKY FUNNY comic type clipart! +
 ART25 HOLIDAYS Holiday type pictures! +
 ART26 HANDBAGS 2 disks full of handbags! +
 ART27 ART NOUVEAU FLOWERS Floral art! +
 ART28 BUTTERFLIES Nice pictures! +
 ART29 FOOD 2 disks on a food/kitchen theme! +
 ART30 COLOURING BOOK Colour in DPaint! +
 ART31 BORDERS 2 disks, most load into DTP! +
 ART32 MAC CLIP 2 disks high quality macart! +
 ART33 HORNBACK Nice scenic clipart! +
 ART34 TEDDY BEARS 2 disks of Teddy bears! +
 ART35 VANITY FARE 2 disks fashion clipart! +

WEIRD SCIENCE:
 Superb! 250 colour hires pictures! 1200 only! order nos. WSAG1 - 5
WEIRD SCIENCE SUPER HAM:
 Fantastic! 26,000 colour hires raytraced & digitized pictures, hardly any different to the 24 bit originals, show to PC owning friends and watch them weep!
 order nos. SH1-45 ... 45 Super discs!
 WSAG46 + 7 JPEG loaders!! These disks contains 24 bit Jpeg pictures which unpack in ram to display as Superham 8 on a 1200 4000 machine!! Brilliant!
 WSAG48-12 5 Jpegs of wildlife pics, 16 megabytes unpacked per disk! displays as superham on 1200! Amazing!
 WSAG45 24bit Jpeg Vista landscapes!
IPEG 24 BIT PICS!
 An amazing 17 disks full of brilliant 24 bit pics by Michel Rigolet. Remember you need lots of memory & some form of 24 bit display to view, or convert to superham! JPI-12

BOULDERDASH GAMES
 We no have over 100 (YES 100!!) Boulderdash games in this mammoth collection. All work on any Amiga 500, 600 or 1200!!
 B0001 EMERALD MINES 01
 B0002 EMERALD MINES 02
 B0003 EMERALD MINES 03
 B0004 EMERALD MINES 04
 B0005 EMERALD MINES 05
 B0006 EMERALD MINES 06
 B0007 EMERALD MINES 07
 B0008 EMERALD MINES 08
 B0009 EMERALD MINES 09
 B0010 EMERALD MINES 10
 B0011 EMERALD MINES 11
 B0012 EMERALD MINES 12
 B0013 EMERALD MINES 13
 B0014 EMERALD MINES 14
 B0015 EMERALD MINES 15
 B0016 NO ONE MINES 01
 B0017 NO ONE MINES 02
 B0018 NO ONE MINES 03
 B0019 NO ONE MINES 04
 B0020 NO ONE MINES 05
 B0021 NO ONE MINES 06
 B0022 NO ONE MINES 07
 B0023 NO ONE MINES 08
 B0024 NO ONE MINES 09
 B0025 NO ONE MINES 10
 B0026 NO ONE MINES 11
 B0027 NO ONE MINES 12
 B0028 NO ONE MINES 13
 B0029 NO ONE MINES 14
 B0030 NO ONE MINES 15
 B0031 LADY RUFFLE MINE 01
 B0032 RUFFLE MINE 1
 B0033 RUFFLE MINE 2
 B0034 RUFFLE MINE 3
 B0035 RUFFLE MINE 4
 B0036 DOWN UNDER MINES 1
 B0037 DOWN UNDER MINES 2
 B0038 DOWN UNDER MINES 3
 B0039 DOWN UNDER MINES 4
 B0040 DOWN UNDER MINES 5
 B0041 DOWN UNDER MINES 6
 B0042 DOWN UNDER MINES 7
 B0043 DOWN UNDER MINES 8
 B0044 DOWN UNDER MINES 9
 B0045 DOWN UNDER MINES 10
 B0046 DOWN UNDER MINES 11
 B0047 DOWN UNDER MINES 12
 B0048 DOWN UNDER MINES 13
 B0049 DOWN UNDER MINES 14
 B0050 DOWN UNDER MINES 15
 B0051 RECYCLED MINES 01
 B0052 RECYCLED MINES 02
 B0053 RECYCLED MINES 03
 B0054 RECYCLED MINES 04
 B0055 RECYCLED MINES 05
 B0056 RECYCLED MINES 06
 B0057 RECYCLED MINES 07
 B0058 RECYCLED MINES 08
 B0059 RECYCLED MINES 09
 B0060 RECYCLED MINES 10
 B0061 RECYCLED MINES 11
 B0062 RECYCLED MINES 12
 B0063 RECYCLED MINES 13
 B0064 RECYCLED MINES 14
 B0065 RECYCLED MINES 15
 B0066 RECYCLED MINES 16
 B0067 RECYCLED MINES 17
 B0068 RECYCLED MINES 18
 B0069 RECYCLED MINES 19
 B0070 RECYCLED MINES 20
 B0071 RECYCLED MINES 21
 B0072 RECYCLED MINES 22
 B0073 RECYCLED MINES 23
 B0074 RECYCLED MINES 24
 B0075 RECYCLED MINES 25
 B0076 RECYCLED MINES 26
 B0077 RECYCLED MINES 27
 B0078 RECYCLED MINES 28
 B0079 RECYCLED MINES 29
 B0080 RECYCLED MINES 30
 B0081 RECYCLED MINES 31
 B0082 RECYCLED MINES 32
 B0083 RECYCLED MINES 33
 B0084 RECYCLED MINES 34
 B0085 RECYCLED MINES 35
 B0086 RECYCLED MINES 36
 B0087 RECYCLED MINES 37
 B0088 RECYCLED MINES 38
 B0089 RECYCLED MINES 39
 B0090 RECYCLED MINES 40
 B0091 RECYCLED MINES 41
 B0092 RECYCLED MINES 42
 B0093 RECYCLED MINES 43
 B0094 RECYCLED MINES 44
 B0095 RECYCLED MINES 45
 B0096 RECYCLED MINES 46
 B0097 RECYCLED MINES 47
 B0098 RECYCLED MINES 48
 B0099 RECYCLED MINES 49
 B0100 RECYCLED MINES 50

NEW! COLOURED CLIPART! NEW!
 This is a superb collection of coloured clipart, mostly in Ham mode (4096 colours), though some is in 16 colours. Can be loaded into Deluxe Paint 4 or any other package accepting Ham pictures!
 OK on 500, 500+, 600, 1200 & 4000!
 CCL001 MAPS, Algarnstan - Botswana, autoboots! +Y
 CCL002 MAPS, Brazil - Czechoslovakia, autoboots! +Y
 CCL003 MAPS, Denmark - Grenada, hires map! +Y
 CCL004 MAPS, Guadel - Illinois, hires maps! +Y
 CCL005 MAPS, India - Luxembourg, hires map! +Y
 CCL006 MAPS, Macau - Mississippi, autoboots! +Y
 CCL007 MAPS, Montana - New York, hires map! +Y
 CCL008 MAPS, Neutral Zone - Iraq - S Dakota! +Y
 CCL009 MAPS, Senegal - Tuvalu, autoboots! +Y
 CCL010 MAPS, Texas - Zimbabwe, autoboots! +Y
 CCL011 REPTILES, good pictures, autoboots! +Y
 CCL012 3 ACTORS, famous faces, autoboots! +Y(2)
 CCL013 BIRDS, 13-29 More avian pictures! +Y
 CCL014 AIRCRAFT, 1-26, assorted, autoboots! +Y
 CCL015 AIRCRAFT, 27-32 & Cars! autoboots! +Y
 CCL016 BIRDS, 131-138 More bird pictures! +Y
 CCL017 BIRDS, 1-12 Super pictures, autoboots! +Y
 CCL018 BIRDS, 13-29 More avian pictures! +Y
 CCL019 BIRDS, 30-41 Lots more birds, autoboots! +Y
 CCL020 BIRDS, Many more bird pics, autoboots! +Y
 CCL021 BIRDS, And some more fab pictures! +Y
 CCL022 BIRDS, 116-130 Some good pictures! +Y
 CCL023 BIRDS, 131-138 More bird pictures! +Y
 CCL024 BIRDS, More superb pictures here! +Y
 CCL025 CATS, 1-16 Super cat pics, autoboots! +Y
 CCL026 35 DOGS, 1-26 Super dog pics, 8 disks! +Y
 CCL027 EXPLOREERS 1-13 famous explorers, autoboots! +Y
 CCL028 40 FISH 1-92 Super fish pictures, 4 disks! +Y
 CCL029 FLOWERS 1-13 Flower pictures, autoboots! +Y
 CCL030 FLOWERS 14-25 More flower pics, autoboots! +Y
 CCL031 FLOWERS 26-37 More flower pics, autoboots! +Y
 CCL032 FLOWERS 38-50 More flower pics, autoboots! +Y
 CCL033 FLOWERS 51-62 More flower pics, autoboots! +Y
 CCL034 FLOWERS 63-74 More flower pics, autoboots! +Y
 CCL035 FLOWERS 75-87 More flower pics, autoboots! +Y
 CCL036 FLOWERS 88-100 More flower pics, autoboots! +Y
 CCL037 FLOWERS 101-113 More flower pics, autoboots! +Y

AMIGA CD ROM COMPACT DISCS!
 Features CD rams for your CDTV or A570 add on!
 CDDP 1 Superfish Fred Fish 1-660, hundreds of music modules, & much much more! 19.95.
 CDTV DEMO DISK Over 600 megabytes of demos, samples, games, clipart, animations & 1000 modules to play 19.95.
 CDDP 2 This CD contains Fred Fish 661-760, the Scope library 1-220, The AB20 archives & much more! 19.95.
 ALIST AIR IN OUTER SPACE Super kids educational title! Only 24.95. Please add 50p per CD for P&P.

NBS
 US 20, ICHAIN LANE, NEWPORT
 LW, PO30 5QA
 TEL: 0983 529 594
 FAX: 0983 821 599

VALLY PD
 US 20, PO BOX 15, PETERLEE
 CO, DURHAM SR8 1NZ
 TEL: 091 587 1195
 FAX: 091 587 1195

BLITTERCHIPS
 US20, CLIFFE HOUSE, PRIMROSE
 STREET, KEIGHLEY, BD21 4NN
 TEL: 0535 667 469
 FAX: 0535 667 469

AMIGA REPAIRS

Repairs undertaken to Amiga 500 computers at £44.95 inclusive of parts, labour, VAT and return postage/packing

Commodore registered for full technical support

Computers repaired in the quickest possible time

All machines will be overhauled with a full soak-test to ensure optimum reliability

Entrust your machine to the experts, full 90 day warranty

Repairs to disk drive and keyboard also included (extra charge possible if found to need complete replacement)

Repairs to other Commodore systems undertaken - phone for details

Upgrades and expansions supplied and fitted - phone for details

£44.95

To take advantage of this exceptional offer, simply send or hand deliver your computer to our workshop complex, address details below, enclosing this advertisement-voucher, payment, fault description, return address, along with your daytime and evening telephone number and we will do the rest. Should you require Group 4 Security return delivery, simply add £5.00 to the repair charge.

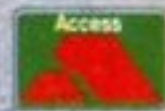

WTS Electronics Ltd Chaul End Lane Luton Bedfordshire LU4 8EZ Tel 0582 491949 (6 lines)

(We reserve the right to reject machines which, in our opinion, are beyond repair- Normal charge applies)

NEW SHOP NOW OPEN
at
295 Ditchling Road
BRIGHTON

BCS CHRISTMAS OFFERS

Full range of Amiga, PC, Sega, Nintendo, & Atari Software in Stock
Easy Parking Available

★ **OFFER 1** ★
NEW Amiga CD32 + Oscar + Diggers
Only £278.99

★ **OFFER 2** ★
NEW A1200 + Nigel Mansells Grand Prix + Trolls (AGA version)
£279.99

★ **OFFER 3** ★
NEW A1200 Standalone Machine
£269.99

★ **OFFER 4** ★
NEW A1200 Desktop Dynamite Pack inc. Wordworth, Print Manager, Deluxe Paint 4, Dennis & Oscar
£329.99

★ **OFFER 5** ★
NEW Amiga 4000 - 030 80Mb HD + 2Mb Fast/2Mb Chip RAM
ONLY £1089.99
Call for New Low Prices on A4 ooo Range

DISKS! DISKS! DISKS!

100% certified error free
PLUS FREE COLOUR CODED LABELS

50	3.5" DS/DD	£22.99
100	3.5" DS/DD	£36.99
150	3.5" DS/DD	£55.99
200	3.5" DS/DD	£69.99
300	3.5" DS/DD	£104.99
400	3.5" DS/DD	£139.99
500	3.5" DS/DD	£174.99
1000	3.5" DS/DD	CALL FOR LATEST PRICE

All prices include VAT/free labels
REMEMBER, THESE PRICES INCLUDE FREE DELIVERY
PLEASE PHONE FOR LATEST PRICES DUE TO POSSIBLE INTRODUCTION OF EC TARIFFS ON DISKS

DISKS + 100 CAP LOCKABLE BOXES

100% CERTIFIED ERROR FREE
PLUS FREE COLOUR CODED LABELS

50	3.5" DS/DD + 100 cap box	£25.99
100	3.5" DS/DD + 100 cap box	£39.99
150	3.5" DS/DD + 100 cap box	£58.99
200	3.5" DS/DD + 2 x 100 cap boxes	£75.99
300	3.5" DS/DD + 3 x 100 cap boxes	£110.99
400	3.5" DS/DD + 4 x 100 cap boxes	£147.99
500	3.5" DS/DD + 5 x 100 cap boxes	£184.99
1000	3.5" DS/DD + 10 x 100 cap boxes	£call

All prices include VAT/free labels
REMEMBER, THESE PRICES INCLUDE FREE DELIVERY
PLEASE PHONE FOR LATEST PRICES DUE TO POSSIBLE INTRODUCTION OF EC TARIFFS ON DISKS

DISKS + 80 CAP BANX BOXES

100% CERTIFIED ERROR FREE
FREE COLOUR CODED LABELS

50	3.5" DS/DD + 80 Cap Banx Box	£32.99
100	3.5" DS/DD + 80 Cap Banx Box	£45.99
150	3.5" DS/DD + 2 x 80 Cap Banx Boxes	£74.99
200	3.5" DS/DD + 2 x 80 Cap Banx Boxes	£89.99
300	3.5" DS/DD + 4 x 80 Cap Banx Boxes	£145.49
400	3.5" DS/DD + 5 x 80 Cap Banx Boxes	£187.99
500	3.5" DS/DD + 6 x 80 Cap Banx Boxes	£235.99

All prices include VAT/free labels & free delivery
PLEASE PHONE FOR LATEST PRICES DUE TO POSSIBLE INTRODUCTION OF EC TARIFFS ON DISKS

3.5" DS/DD Disks

60p each

100 3.5" DS/HD ..£61.00 INC. P&P

150 Cap 3.5" Posso Box£16.50
70 Cap 5.25" Posso£16.50
60 Cap 3.5" Stackable Box£10.00

3.5" 10 Cap boxes£0.85 each
3.5" 40 Cap boxes£4.10 each
3.5" 100 Cap boxes£4.50 each
5.25" 10 Cap box£1.10 each
5.25" 50 Cap boxes£5.10 each
5.25" 100 Cap boxes£5.90 each

5.25" DS/DD Disks21p each
5.25" DS/HD Disks39p each

PRINTER RIBBONS

PRINTER	BLACK	COLOUR	
	BRANDED	COMP BRANDED	
Citizen 120D	£3.40	£2.70	N/A
Citizen Swift 9	£3.40	£2.70	£15.30
Citizen Swift 24/24E/224	£4.70	£2.70	£15.30
Panasonic 1124	£8.50	£3.58	N/A
Star LC-10	£4.47	£3.06	£6.70
Star LC-20	£4.47	£3.06	N/A
Star LC200	£6.11	£4.70	£12.30
Star LC24 10/15	£5.58	£3.53	N/A
Star LC24-200	£5.58	£3.53	£13.25

Call for prices on any ribbon

ACCESSORIES/JOYSTICKS

1000 COLOURED LABELS	£8
1000 TRACTOR LABELS (WHITE)	£10
AMIGA MOUSE	£15.95
MOUSE MAT	£2.75
MOUSE HOLDER	£2.50
14" MONITOR STAND	£10
PRINTER STAND	£6
3.5" CLEANING KIT	£2.75
PRINTER RIBBONS	£CALL
PARALLEL LEAD	£8
ZIPSTICK	£11.50
QS PYTHON IIIM	£9.50

CITIZEN 240C + FREE PENPAL

£274.99

MICROVITEC 14" COLOUR MULTISYNC MONITOR

£399.99

INKJET CARTRIDGES & REFILLS

HP Deskjet Black Ink Cartridge	£17.50
HP Deskjet Black Dual Capacity Ink Cartridge	£27.47
HP Deskjet 500C Colour Ink Cartridge	£29.37
Canon BJ10e/ex Black Ink Cartridge	£16.99
Black Twin Refill Kit	£14.98
Colour Twin Refill kit (3 cols)	£29.85
500C Colour Refill Kit	£14.98
Amiga Colour Separation Software	£39.95

DUST COVERS

A500	£3.50
A600	£3.50
STAR LC200	£3.50
STAR LC-24 200	£3.50
CITIZEN 9	£3.50
CITIZEN 24	£3.50
PHILIPS MKI/II	£3.50
ATARI	£3.50

ORDER HOTLINE:

0273 506269 / 0831 279084

All prices include VAT. Add £4 delivery unless stated.
Add £10 next day. Cheques will be held for clearance.

Call or send cheques / postal orders to:
BCS Ltd., 295 Ditchling Road, Brighton, East Sussex BN1 6JH

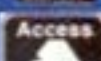

All offers subject to availability. E&OE. Due to shortages of 3.5" DSDD disks, prices may change without notice. Due to currency fluctuation, all prices may change without notice.
Licensed Credit Brokers for Lombard Tricity Finance Ltd.



Sex Pistols, smoking, sick, surrealism, Star Trek, soap operas, and... erm... circuses. Yes, you get them all in the PD Demo Zone, and you even get a free replica of Andy Nuttall to tell you about them.

PD Demo Zone

AKIRA SLIDESHOW 2 ANIM

17-BIT, DISK 2695

After Marvel comics, Manga's Japanese style of animation is probably the most popular subject for an Amiga PD slideshow, with three or four good shows appearing in the first half of this year. Robert Iveson's work is pretty patchy, but there are some really good images which are worth seeing.

Each of the images is either hand-drawn in hi-res mode, or scanned in monochrome and recoloured. Where Robert falters occasionally is in the definition of his drawings: sometimes the images are blurred when they should be sharp, sometimes he uses a stippling effect when the colours should be uniform, as they are in the film itself. Roll on *Akira Slideshow 3*, though.



One of the fight sequences from the film, apparently. I don't remember it myself, I must admit.



Ahh, this is more like it. Kaneda (from the film, actually) in a typical action-packed pose.

CIRCUS ANIM ANIM

17-BIT, DISK 2684



The band played on though the fireman was on fire, the human cannonball in orbit, and the fakir in pain...

Carl Inc is set to achieve cult status with his set of bizarre animations. First there was the fairly daft *Christmas Demo* (reviewed AF42), then the *Boat Anim* (Reviewed AF44), and now this.

Like the previous two shows, *Circus* is a looped anim in the style of the now-ancient Ariston adverts (where the action loops on, and on, and on). An Indian Fakir on a bed of nails blows fire onto a moving cannon, firing a human cannonball through the roof of the marquee; a dog jumps through a pair of hoops; the top half of a woman's dress falls down, causing her to blush. Loads of things go on in the same screen, and it takes a few minutes to spot them all. Good fun.

242 DEMO

TELESCAN

The first message to be displayed in this demo contained the words "Fairlight cracked," at which



Although the music is disappointing (if, like me, you're a Front 242 fan), the digitised graphics are superb.

point I was about to stick the disk in the bin. The 242 demo started quickly, though, and it's... interesting. Technically very clever, boasting 29Mb (really?) of graphics packed on to a single disk, it's a near full-motion video of somebody walking around a shopping centre.

Fans of the Belgian band Front 242 should have recognised the title, but the demo has very little to do with them - in fact, the music isn't even in their industrial style. The only reference to Front 242 is at the end of the demo, when the guy in the picture wanders into a record shop and pulls out a Front 242 CD. The acid/rave style soundtrack is good, but not quite the heavy dance music I expected.

ALTERNATE REALITY ANIM

17-BIT, DISK 2686

Fans of the bizarre will enjoy this. In a similar vein to the *Circus Anim*, *Alternate Reality* is a landscape image with lots of surreal animations going on based around the landscape. For example, a cloud



We've all had that morning after feeling - snow on your cap, ice in your crevasses, tongue like a ski-run...

in the sky is sucked into the top of the mountain, then spat out again forming a snow cap. A tongue then pops out of the sky, creating an image of a face, and a skier zooms down the tongue and off into the distance.

The music is just like the stuff they play at the cinema when they ask you not to smoke and to go and buy popcorn. The graphics could be a lot better, but the surrealist ideas are interesting.

ROMANTIC CYNOSTIC PD DEMO

The new Melon Dezin demo is very weird. It seems they've taken seriously people's comments about PD demos becoming very similar, and gone to the other extreme. The demo is introduced by a kind of photo-love story involving hi-res digitised pics of the *Beverly Hills 90210* cast, all talking about the new Romantic demo which they've just downloaded, while a twangy electric guitar plays a rendition of the 90210 theme tune. Odd.

Continued overleaf

THE CHRONICLE SLIDESHOW

SLIDE

MAGNETIC FIELDS, DISK SS045

A set of low-res ray-traced images squeezed on a single disk by coders Trance. The pics have only 64 colours, so they run on all Amigas, but even so some of the results are very nice - especially the images shown here. Subjects include the inside of a prison cell, a turbine engine, and a tree - a diverse selection. A heavy backbeat pounds away in the background as the ten images are decrunched and displayed one by one.

With the new A1200 stealing the limelight from its older brothers, it's good to see quality ray-traced images in 64 colours. Even so, let's see the same slideshow rendered in HAM8 mode - that would be something else!



Using just 64 colours, the turbine (an enormously complex model) looks good even on an A600.



These ray-traced eggs prove similarly that it's possible to create good-looking ray traces with fewer colours.



The crowd of *Beverly Hills 90210* get their teeth out to greet you in this demo. Is this good or bad? You decide. The main Melon demo image is the weird doll, inset.

The demo itself is a picture and a long scrolly message. Oh, yes, and a sample of the Sex Pistols' *Anarchy in the UK* which sounds throaty and really grunged up (probably a Melon coder in his garage). Excellent, but there's a fair amount of strong language in the text - sexually explicit, and pretty unnecessary. Still, now I've warned you.

STAR TREK - THE NEXT GENERATION SLIDES VOLUME 1

SLIDE

MAGNETIC FIELDS, DISK SS042

These *Next Generation* demos are proving quite popular lately (at least with the authors, if not with the reviewers.) After the debacle of the slideshow *Deep Space Nine* last month, I thought that might be the last we'd see of poorly-digitised images of the *Star Trek* cast. Not the case.

The images on this demo are better than those on the *Deep Space Nine* disk. But as long as colour composite digitisers are used, the results are going to be poor. Still Trekkies will love them.



Gynon (Whoopi Goldberg), Jean-Luc (Patrick Stewart) and a Borg (um, Bob Holness) in all their blurry glory.

VOMIT TELESCAN

DEMO

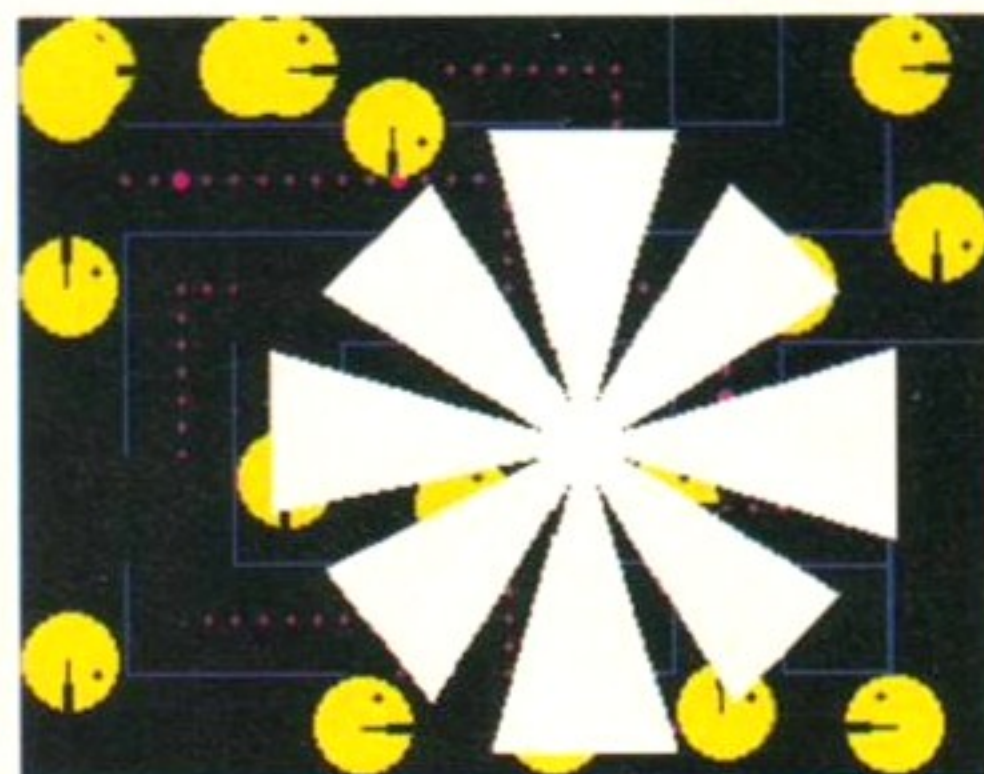

Innocent Pacmen are being mercilessly thrown into demos like this - sometimes up to 20 to a maze.

Presumably this epilepsy-inducing little music and graphics number is named after the feeling you get when you've sat all the way through the demo. *Vomit* is a brazen and outrageous mish-mash of colours and shapes flashed in time with a techno soundtrack. Not just any old colours either - this specialises in the throw-worthy and so disgusting purple and magenta are the overriding hues.

Other than that, the demo is almost exactly the same as *State of the Art*, but without the clever morphing and animation techniques which that rival demo puts to good use.

This is a new concept in trackmos, though - not just fit-inducing but also vomit-inducing. How sick can these people get? Seriously, not a bad demo - but next time, not so heavy on the diced carrots please, coders!

3 WAYS TO STOP SMOKING

ANIM

TELESCAN

This, er, delightful little animation tries to offer nicotine-addicted Amiga fans the best three ways to give up the evil weed... or at least the best which spring from the fevered depths of the animator's imagination.

His ideas are very good, in that the poor guy demonstrating the methods involved will probably never smoke again. Jumping from the roof of a tall office block, driving your car off the top a cliff and chopping your arm off with a meat cleaver are the three somewhat radical ideas which are given the full cartoon animation treatment.

The ideas aren't new, every single one having been done before by cartoon animators, and they're not even very well animated. But, they are sick and twisted, so fans of sick and twisted stuff will smirk. Like me.



Our... errm... hero takes a last couple of drags before giving up - giving up his left hand, that is!

THIS MONTH'S TOP 10 GAMES & UTILITIES

Every month, we peruse the best seller lists of a prominent PD company. This month, it's the turn of...

CYNOSTIC PD (YET AGAIN!)

1	Pygmy Projects "Extension"	D0182	6	Arise "Pure Style"	D0155
2	Sagazity "Insane"	D0172	7	Genocide "Aural Illusions"	S0156
3	Abyss "Music for the Lost"	S0153AB	8	KK "Drink Tea" [Needs FastMem]	D0175
4	IBB "Manga S/S" [Needs FastMem]	P0056AB	9	NFA "Bodyshop #2" [AGA Only]	P0055AB
5	Energy "Rhythm Device"	S0157	10	LSD "Simply the Best #54"	D0188

WHERE TO GET THE DISKS IN THIS ISSUE

CYNOSTIC PD, 85 Wyken Croft, Coventry CV2 3AD. 0203 613817

TELESCAN COMPUTER SERVICES, 1a Grantham Road, Blackpool FY1 2RF. 0253 22296

17-BIT SOFTWARE, 2-8 Market Street, Wakefield WF1 1DH. 0924 366982

MAGNETIC FIELDS, PO Box 118, Preston, Lancashire PR2 2AW. 0772 881190



DISCOVERY P.D.

TEL 0274 880066

WHY NOT USE OUR TELEPHONE HOTLINE FOR SAME DAY DESPATCH. CREDIT CARDS WELCOME.

SPECIAL OFFERS

- FOR EVERY 10 P.D DISKS YOU BUY, WE WILL GIVE YOU A 10 CAP BOX WORTH £1.99 ABSOLUTELY FREE!
- FOR EVERY 25 P.D DISKS YOU BUY, YOU CAN CHOOSE ANOTHER 5 FREE!



(No.) = HOW MANY DISKS TO ORDER, EG (2) = 2 DISK PACK

- #### DEMOS
- D1...Mental Hangover
 - D2...Interceptor Demo
 - D4...Wild Copper
 - D10...17Bit Music Demos
 - D11...World Demos 21
 - D13...Total Remix Demo
 - D14/15...Predators (2)
 - D20/21...Red Sector (2)
 - D24/25...New Tek Real 3 (2)
 - D26...Total Remix 2 Demo
 - D27...TV Theme
 - D30...Epic Demo
 - D34...PD Collection
 - D36...Virtual Worlds
 - D37...Vectra Sinking Demo
 - D38...TFF Demo Voyage
 - D40...Safy Demo
 - D59...Video Effects 3D
 - D64...Cult Vector Dance 2
 - D68...Phenomena Demo
 - D70...Amos 3D Demo
 - D74...A Trip to Mars
 - D76...A2000 Genlock Demo
 - D81/82...Budbrain 1 (2)
 - D83...Budbrain 2
 - D85...Cronics Neverwhere
 - D87...Piranha Demo
 - D101...Alcatraz M/Demo 3
 - D102...A Chaplin Demo
 - D103...Total Destruction
 - D105...Mr B Demo Comp 4
 - D106...Water S.T Demos
 - D111...Defcon 1
 - D117...Aurora M/Demo
 - D118...Cult M/Demo 2
 - D125...Precise Demo
 - D133...Fascination
 - D136...Goldfire Megademo
 - D137/138...So What (2)
 - D139...Devils "No Reality"
 - D144...The Silents "Ice"
 - D145...Crystal Symphonies
 - D148...Ray Of Hope 2
 - D149...No Brain No Pain
 - D158/159...Cyborg Demo (2)
 - D195...Coaxial Comp
 - D197...MC Disk 1 Coma
 - D199...End Of Century 1999
 - D206...Dreamers 3
 - D208...Avengers M/Demo
 - D216/217...Bass o Matic (2)
 - D218...Disorder Demo
 - D219...Tuff Enuff
 - D225...Cool Fridge Demo
 - D226...Hardrock M/Demo
 - D233...Hypnautic Hammer
 - D235...Six of One Demo
 - D238...Planetside
 - D239...Lemmings Revenge
 - D240...Total Respray
 - D243...Budbrain 3
 - D244...Phenomena Inertspace
 - D245...Total Retrial
 - D247...Pulling the Trigger
 - D253...CES Demos
 - D256...Total Recount
 - D257...Total Rebate
 - D262...Spasmolytic
 - D264...D-Mob M/Demo
 - D267...Sun Connection 2
 - D270...Kefrons The Wall
 - D271...Timex Hydra
 - D272...Electric Demos 1
 - D274...Defpackers Demo
 - D276...Cave La Weird
 - D279...Iraqi Demo
 - D280/281...Delerious (2)
 - D290...Popeye Demo
 - D292...Excalibur Demo
 - D298...Silents + Anarchy
 - D301...Subway Demo
 - D302...Tarot Demo
 - D303...Despair Demo
 - D307...L.S.D Demo
 - D312...Devils Colours
 - D314...Trakmo
 - D315...The Groove Ramjam
 - D322/323...Star Wars (2)
 - D325/326...Real Empathy (2)
 - D328/329...Red Dwarf (2)
 - D330...Darkness M/Demo
 - D332...Melted Experience
 - D333-337...Odyssey (5)
 - D338...Beastie Boys Demo
 - D340...Watchman Demo
 - D341...Anarchy Smoker Co
 - D342...Ed 209 The Revenge
 - D343/344...Hardwired (2)
 - D346...Wildfire M/Demo
 - D347...Mindwarp M/Demo
 - D348/349...Skizzo Demo(2)
 - D350-352...Tracete Team(3)
 - D358...Mr Men Stories
 - D359...Seeing is Believing
 - D360...State of the Art
 - D361...Mayday Resistance
 - D362/363...Jesus on E's(2)
 - D364...Fish Tank
 - D365...Optimum Pressure
 - D366...Mind Riot
 - D367...In the Can Demo
 - D368...Dynamic Illusions
 - D369...Piece of Mind
 - D370...3D Demo 2
 - D371...Lethal Exit

- #### UTILITIES
- U1...Games Music Creator
 - U21...The Comms Disk
 - U32...Modern Utis
 - U34...Red Devils Utis 1
 - U36...Soundtracker Special
 - U38...Paint, Music, Media
 - U39...Card Designer
 - U40...Spectrum Emulator
 - U41...Red Devils Utis 4
 - U43...Future Composer
 - U44...Kefrons Makeboot
 - U45...PE Giant Utis 168
 - U47...Label Designer
 - U49...Ultimate Icon Disk
 - U50...Power Comp Utis
 - U51...Jazz Bench
 - U55...Visicalc
 - U57...Quickbench
 - U59...Font Designer
 - U60...D-Print Fonts 1
 - U61...D-Print Fonts 2
 - U62...Med 3.20
 - U63...Direct Anim Creator
 - U64...Crossword Designer
 - U68...CLI Help + Others
 - U67...S/Tracker Mega
 - U68...Ultimate Boots 1
 - U69...Ultimate Boots 2
 - U73...Powerlogo
 - U74...M-Cad
 - U75...Journal Home Acc's
 - U76...Home Utilities
 - U77...Electroad
 - U78...Ami Base
 - U81...Bootbench V2.0
 - U82...Slideshow Maker
 - U83...Catalog Workshop 1
 - U84...Catalog Workshop 2
 - U87...Hard Disk Utis
 - U89-94...Amateur Radio (6)
 - U95...C-Light + Others
 - U96...GFX Utis 1
 - U100...Ham Lab
 - U101...Sid V2.0
 - U108...A-Gene
 - U113...Midi Utilities
 - U118/119...Video Utis (2)
 - U132...GFX Utis 2
 - U133/134...North C (2)
 - U136...CrossDoss (demo)
 - U138...Squid Squad Utis
 - U139...Terminalities V1.0
 - U140...Squash 1 (2.04 only)
 - U141...Squash 2 (2.04 only)
 - U142...Text Plus 3
 - U144...Dennis Samples 1
 - U145...Digital Intro Design
 - U146...Viz Clip Art
 - U147...Spectrum Emulator
 - U151...Slipstream V/Killers
 - U152...Red Devils Utis 6
 - U154...Amigafox W/P
 - U155...PD Utis Docs Disk
 - U163...Quidbench + (2.04)
 - U164...Rim Database
 - U166...Dennis's Hack Disk
 - U167...Demolisher Utis
 - U168...Home Business 3
 - U172...Squelch (1.3 only)
 - U176...GFX Utis 3
 - U177...Star Charts
 - U179...180...Dice (2)
 - U181...Celtic Demo Maker
 - U186...206...Track Ins 10-30
 - U207...Icon Collection 1
 - U208...Dave Jones Fonts 1
 - U210...Ultrapaint 3
 - U211...Chemesthetics
 - U212...Animated Pointers
 - U213...Desk Top Publisher
 - U214...Deskbench Icons
 - U215...Messy Sid 2
 - U216...Master V/Killer 2.2
 - U218...Data Base Wizard
 - U223...Ten Pin Database
 - U224...Q-Base Database
 - U226...Games Solutions 1
 - U231...D-Print Fonts 3
 - U232...Games Cheats 2
 - U234...Flexi Base
 - U235...Ami Cash V1
 - U238...Iconmania
 - U240...Icon Editor
 - U252...Opticomms 2.0
 - U254...New Superkillers 2
 - U255...Protracker v2.0
 - U256...Atari ST Emulator
 - U258...D-Copy 3
 - U262...PC Emulator
 - U263...Med 3.21
 - U273...Vidi Fonts 1
 - U274...Illinoi Labels
 - U275...600 Business Letters
 - U279...Invoice Printer
 - U280...Woman V2.02D
 - U283...Headline Fonts
 - U289...Amos Updater
 - U290...Kickstart 2.04
 - U292...Black Tiger Utis 1
 - U293...Black Tiger Utis 2
 - U294...Text Engine V4.0
 - U295...Game Tamer
 - U296...Ultimate Disk Crea
 - U297...10 PD Copiers
 - U298...Protracker V3.0

- #### GAMES
- G1...Return to Earth
 - G2...Games Comp 5
 - G3...Dizzy Lizzy
 - G4...Scum Haters
 - G5...Parachute Joust
 - G6...Frantic Freddie
 - G8...Twintris
 - G9...Pneumo Cop
 - G10...Drip
 - G11...Bug Bash
 - G12...Asteroids
 - G13...Llamatron
 - G14...Escape From Jovi
 - G15...Moria Adventure
 - G16...Ground Attack
 - G17...Megaball
 - G18...Insiders Club
 - G19...Various Adventures
 - G20...Battleforce
 - G22...Dragon Cave
 - G24...Rings of Zon
 - G25...Mayhem
 - G26...Mechflight
 - G27...The Tennis Game
 - G28...Flaschbier
 - G29...Buck Rogers
 - G30...Greyslayer
 - G31...7-Tiles
 - G32...Mega Comp 1
 - G33-34...Star Trek 1 (2)
 - G35-37...Star Trek 2 (3)
 - G38-39...Mechforce (2)
 - G40...Klondyke
 - G42...Car
 - G43...Games Comp 2
 - G44...S.E.U.C.K Games
 - G45...Sacc Games Comp
 - G46...Games Comp 3
 - G48...Rays Game Disk
 - G49...Games Comp 4
 - G50...Games Comp 6
 - G51-52...Trucking (2)
 - G53...Jetpac
 - G55...Quick and Silva
 - G56...Miniblast
 - G57...Lamer Game
 - G58...Games Comp 7
 - G59...Games Comp 8
 - G60...Pom Pom Gunner
 - G61...Caverunner
 - G62...Crystal Caverns
 - G63...Intact
 - G64...Eternal Rome
 - G65...Lemmings
 - G66...Downhill Challenge
 - G67...Lame ST Ports
 - G68...Paranoid
 - G69...Puggles
 - G70...Chainsaw Death
 - G71...Pirate Pete's Treasure
 - G72...Serene 2
 - G73...Castles
 - G74...Dynamite Dick
 - G75...Card Games 1
 - G76...Wizzy's Quest
 - G77...Growth
 - G78...Skate
 - G79...Atic Atac
 - G80...Napoleonic Sim
 - G81...Project 1
 - G82...Lazer Zone
 - G83...Lemmings Pack
 - G84...Star Trek S.E.U.P
 - G85...Lextrix
 - G87...Matched Pairs
 - G88...Raphaels Revenge
 - G89...Snake Pit
 - G90...Zeus
 - G91...Merv The Merciless
 - G92...Blizzard
 - G93...The Maze Game
 - G94...Subculture
 - G95...Hollywood Trivia
 - G97...Shootout
 - G99...Holy Grail Adventure
 - G100...Amos Coindrop
 - G101...Classic Comp 1
 - G102...Card Games 2
 - G103...Super Skoda Chall
 - G104...Grand Prix Sim
 - G105...Games Comp 9
 - G106...Computer Conflict 2
 - G107...Mission X Raid 2
 - G108...NU Game
 - G109...Antup + Slot Cars
 - G110...Tricky + The Turn
 - G111...Marble Slide
 - G112...Games Comp 10
 - G113...Black Jack Lab
 - G114...Dungeon of Madroj
 - G115...Amiga Columns
 - G116...Robocop In Iraq
 - G117...Mutant Camels
 - G118...Games Comp 11
 - G119...Number Fumbler
 - G120-122...Warlock (3)
 - G123...Card Sharp 1
 - G124...Bart Simpson
 - G125...CC Games Comp
 - G126...Air Ace 2
 - G127...Breakout Con Kit
 - G128...Pipeline
 - G129...Dung of Doridian
 - G215...Amos Games 1
 - G212-214...Timelords 6-8

- #### ANIMS
- A1...Probe Sequence
 - A2...Ghost Pool
 - A3...Jogger + Magician 1
 - A4...Gymnast Demo
 - A5...Fractal Flight
 - A6...Basketball Demo
 - A9...Magician 2
 - A10...Pugs In Space
 - A11...Luxor Teenager
 - A13...Juggler Demo
 - A16...Cool Cougar
 - A17...Mono Cycle Anim
 - A18...Robocop Anim
 - A20...Mayhem on Wheels
 - A21...Jugette 2
 - A22...Shuttlecock Anim
 - A23...T-Pot Anim
 - A27...Fleet Manouvre
 - A28...Billiard Anim
 - A29...E/Prise Leaves Dock
 - A30...Star Wars 2 Anim
 - A31...Star Trek Anim
 - A32...Fraxion Revenge
 - A34...Madonna Anim
 - A35...Stealthy Anims 2
 - A36...Raiders Of The Lost Ark
 - A37...Bugs Bunny Show
 - A38...Iraq V's UK Anim
 - A39...Mike Tyson Anim
 - A40...Knight Anim
 - A42...Walker 2
 - A43...Walker 3
 - A45-46...Light Cycle (2)
 - A47...Exploding Head
 - A48...Police Car Chase
 - A49...Top Gun Demo
 - A50...Animators Demo
 - A51...5 Ways to Kill a Mole
 - A52...Another 5 Ways
 - A53...Batman The Movie
 - A54...3D Spaceship
 - A55...Mr Potato Head
 - A57...Camouflage
 - A58...VGA Anim 4
 - A59...Low Level Flight
 - A63...Army V's Walker
 - A64...Real Pinball Anim
 - A65...Franklin The Fly
 - A66...Porky Pig Anim
 - A67...Adventures of Chuck
 - A69...Bunsen Burner
 - A70-71...Max Overdrive (2)
 - A73...Spaceshuttle Anim
 - A74...Ghostbusters + Horse
 - A76...Alarm Anim
 - A77...Flight Anim
 - A78...Piano Anim
 - A79...Dart Anim
 - A80...Bad Bird Anim
 - A81...Holiday Anim
 - A82...Fillet The Fish
 - A83...The Boings
 - A84...Clothes Peg
 - A85...Miners Anim
 - A86...Pocket Watch Anim
 - A90-93...The Movies 2 (4)
 - A95...My Tin Toy
 - A96...T-Pot 2 Anim
 - A99...Terminator 3
 - A100...Dolphin Dreams
 - A101/102...Thunderbirds (2)
 - A103...Histor Of Army
 - A104...Pogo Anim (2 Meg)

- #### SLIDES
- S1...Ham Pics Show 1
 - S4...Madonna Slides
 - S5...Moviestar Slides
 - S6...Party Disaster
 - S8...Immaculate Collection
 - S9...Simpsons Slides
 - S10-11...Channel 42 (2)
 - S12...Bruce Lee Slides
 - S14...Addams Family
 - S15...Viz Mag Slides
 - S16...Boris 13
 - S17...Docklands Jarre
 - S18...Dr Who Demo
 - S19...Napalm Death
 - S20...Nasa Slides
 - S21...Exodus 3D Slides
 - S22-24...WWF Slides (3)
 - S26...Cascade Demo
 - S27...Demons Slides
 - S28...Total Recall
 - S29...Joe's Slides
 - S30...Ham Pics Show 2
 - S31...D-Print Slides
 - S32...Neighbours Slides
 - S33...Roger Dean Slides
 - S34...Iron Maiden Slides
 - S35-36...Tobias Richter (2)
 - S37...Joe Trsi Slides
 - S38...Basket Case 2
 - S39...Ecos Slides
 - S40...Fraxion Devine 2
 - S41...Fraxion Devine 1
 - S42...Golems Gate Slides
 - S43...Chainsaw Slippers
 - S44...Cry For Dawn
 - S45...Forgotten Realms (2)
 - S47...Kick Off 3 Slides
 - S48...PD Slideshow
 - S49-52...Terminator (4)
 - S53...Robocop 2 Slides
 - S54...Trackmaster Slides
 - S55...Forgotten Realms 2
 - S56...Garfield Slides
 - S57...Pawnbroker Slides
 - S58...Hellraiser Slides
 - S59...Night Breed Slides
 - S60...Raytracing
 - S61...Horror Slides
 - S63...Tate Gallery 2
 - S64...Rock Star Manager
 - S65...Images Slides
 - S70...Muscle Mania
 - S71...Creature Comforts

- #### CLR LICENCEWARE
- CLE01...DINOSAURS (LEARN ALL ABOUT CERTAIN TYPES OF DINOSAURS I.E. JURASSIC, TRIASIC AND CRETACEOUS, ON 2 DISKS £4.50)
 - CLE02...GEOLOGY (WANT TO KNOW ALL ABOUT THE VOLCANOS AND THEIR SUBSTANCES THEN TRY THIS 2 DISKS £4.50)
 - CLE03...SOLAR SYSTEM (GET TO KNOW MORE ABOUT THE SOLAR SYSTEM WITH INFORMATION ON PLANETS ETC AND WITH PICTURES TO LOOK AT 3 DISKS £4.99)
 - CLE04...COLOURING PAD (A UNIQUE COLOURING BOOK TO KEEP THE KIDS AMUSED FOR HOURS 1 DISK £3.50)
 - CLE05...A - CHORD (LEARN TO PLAY THE GUITAR BY LISTENING TO NEARLY EVERY SINGLE CHORD AVAILABLE ON THE INSTRUMENT 1 DISK £3.50)
 - CLE06...MATHS INSTRUCTOR (HELP YOURSELF GET THROUGH THE GCSE'S WITH THIS SUPERB MATHS INSTRUCTOR TRIG, QUADRATIC, SIMULTANEOUS, VOLUMES, AREA ETC ETC 1 DISK £3.50)
 - CLE07...FRESHWATER FISHING (THINK YOU KNOW ALL ABOUT FISHING? TRY THIS 2 DISKS £4.50)
 - CLE08...NIGHT SKY (LOOK AT THE STARS PLANETS ETC FROM ANYWHERE ON THE FACE OF THE EARTH AND CLICK ON A DISPLAYED OBJECT FOR INFO 2 DISKS £4.50)
 - CLE09...WORDS + LADDERS (A WORD SPELLING GAME FOR 1 OR 2 PLAYERS 1 DISK £3.50)
 - CLE10...BASICALLY AMIGA (GET TO KNOW YOUR AMIGA TO THE FULL 3 DISKS £3.50)
 - CLE11...LETS LEARN V1.1 (LEARN SUMS, TUNES, CODES ETC ON THIS EXCELLENT LEARNING AID AGE RANGE FROM 5 - 7 1 DISK £3.50)
 - CLE12...ALPHABET TEACH (TRY TO SPELL WHAT YOU SEE ON THE SCREEN 1 DISK £3.50)
 - CLE13...HOME BREW (WITH RECIPES TO INSTRUCTIONS ON FERMENTING ETC LEARN HOW TO MAKE HOME MADE WINE 1 DISK £3.50)
 - CLE14...ECOLOGY (LEARN MORE ABOUT ECOLOGY WITH THIS BRILL PROGRAM 3 DISKS £4.99)
 - CLU01...VIDEO TITLER (MAKE YOUR VIDEOS LOOK PROFESSIONAL SCROLLERS ETC 1 DISK £3.50)
 - CLU02...FISH INDEXER (MAKE PVE CHARTS GRAPHS ETC WITH FIGURES 1 DISK £3.50)
 - CLU05...SAS MENU MAKER (MAKE MENUS TO SUIT YOU 1 DISK £3.50)
 - CLU06...SUPER SOUND 3 (CREATE YOUR OWN TUNES WITH THIS MUSIC UTILITY 2 DISKS £4.50)
 - CLU10...POWER ACCOUNTS (KEEP ACCOUNTS OF YOUR EXPENDITURE WITH PASSWORD FUNCTION 1 DISK £3.50)
 - CLU11...CALC V1.3 (AN EXCELLENT SPREADSHEET FOR THOSE CROSS CALCULATIONS 1 DISK £3.50)
 - CLU12...VIRTUAL WINDOWS 1 (A COLLECTION OF USEFUL UTILITIES LIKE ADDRESS BOOK, NOTE PAD, SOFTWARE CATS ETC 1 DISK £3.50)
 - CLU13...DATOS (EASY TO USE YET VERY POWERFUL DATABASE 1 DISK £3.50)
 - CLG01...NORRIS (A VERY ADDICTIVE GAME SET IN THE MEDIEVAL ERA 1 DISK £3.50)
 - CLG02...DARK THINGS (A BRILL PLATFORM SCROLLY GAME 1 DISK £3.50)
 - CLG03...PHASE 2 (AN EXCELLENT SIDEWAYS SCROLL SHOOT EM UP GAME 1 DISK £3.50)
 - CLG04...X-SYSTEM (A VERY ADDICTIVE GAME WITH THE USUAL END OF LEVEL MONSTERS 1 DISK £3.50)
 - CLG05...TRUCKING ON (TRY AND MANAGE YOUR OWN TRUCK FLEET EXCELLENT 2 DISKS £4.50)
 - CLG06...OBLITERATION (ANOTHER FAST SHOOT EM UP TYPE GAME 1 DISK £3.50 NOT PLUS COMP)
 - CLG08...DRAGON TILES (OLD JAPANESE TYPE MAJ JONG STYLE GAME 1 DISK £3.50)
 - CLG09...MOTOR DUEL (DRIVE A 3D CAR SHOOTING AND RACING WITH OPPONENTS 1 DISK £3.50)
 - CLG10...FUTURE SHOCK (A CASE OF GETTING THE BALL THROUGH THE MAZE 1 DISK £3.50)
 - CLG11...ALL GUNS BLAZING (CAR GAME FOR 2 PLAYERS WITH THE OVERHEAD VIEW THEME 1 DISK £3.50)
 - CLG12...BULLDOZER BOB (WIPE OUT THE SCREEN OF COLOURED BLOCKS 1 DISK £3.50)
 - CLG13...PARADOX (A PUZZLE GAME TO TEST THOSE POWERS OF SOLVING 1 DISK £3.50)
 - CLG14...SONIC SMARTHEAD (ANOTHER PLATFORM STYLE GAME 1 DISK £3.50)
 - CLG15...SPLODGE THE REVENGE (ANOTHER PLATFORM GAME WITH PUZZLES TO SOLVE 1 DISK £3.50)
 - CLG17...IMBRIUM DAY OF RECKONING (ONE OF THOSE GRAPHIC ADVENTURE TYPE GAMES EXCELLENT! 1 DISK £3.50)

- #### ASSASSINS PACK
- | | | |
|----------|------------|------------|
| 10 DISKS | £1.50 EACH | £10.50+p&p |
| 30 DISKS | | £28.50+p&p |
| 40 DISKS | | £34.50+p&p |
| 54 DISKS | | £43.00+p&p |
| ALL 70 | | £60.00+p&p |

- #### ACCESSORIES
- MOUSE HOUSE.....£1.99
 - MOUSE MAT.....£2.80
 - SMOKE MOUSE.....£19.99
 - 10 CAP BOX.....£1.99
 - 100 CAP BOX.....£6.99
 - A500 DUST COVER.....£3.99
 - A600 DUST COVER.....£3.99
 - 3.5" BLANK DISKS.....£0.69
 - PRINTER STAND.....£4.99
 - MONITOR STAND.....£10.99
 - MONITOR COVER.....£4.99

- #### PRICES
- | PUBLIC DOMAIN | | POSTAGE | |
|---------------|------------|---------------|-------|
| 1-9 DISKS = | £1.50 EACH | Europe PD = | 60p |
| 10+ DISKS = | £1.25 EACH | Accessories = | 90p |
| 20+ DISKS = | 99P EACH | World PD = | £1.50 |
| | | Accessories = | £1.90 |

- #### RAVE & TECHNO PACK
- ORDER NO P.01
- DANCE IN STYLE WITH ALL THE LATEST RAVE AND TECHNO SOUNDS. AVAILABLE ON THE AMIGA. THIS PACK IS A MUST FOR ALL YOU RAVERS.
- 10 DISKS FOR ONLY £9.50 + P+P
-
- #### BUSINESS PACK
- ORDER NO P.04
- WHETHER IT'S JUST TYPING A LETTER OR KEEPING A RECORD OF YOUR FINANCES. THIS PACK IS A DEFINITE MUST!
- 10 DISKS FOR ONLY £9.50 + P+P
-
- #### EDUCATIONAL PACK
- ORDER NO P.02
- THIS PACK CONTAINS EVERYTHING FROM LEARNING LANGUAGES TO PLAYING GAMES, AND AGES RANGE FROM 4 TO ADULT.
- 15 DISKS FOR ONLY £14.50 + P+P
-
- #### ROCKFORD PACK
- ORDER NO P.06
- A COLLECTION OF GAMES WHICH ALL INCLUDE THE BOULDERBASH GAMES THEME. IT ALSO HAS AN EDITOR SO YOU CAN MAKE YOUR OWN CAVES.
- 10 DISKS FOR ONLY £9.50 + P+P
-
- #### C64 EMULATOR PACK
- ORDER NO P.05
- THIS PACK EMULATES THE AMIGA INTO A C64 WITH OVER 50 GAMES TO CHOOSE FROM. COMES WITH FULL INSTRUCTIONS.
- 3 DISKS FOR ONLY £3.75 + P+P
-
- #### CLIP ART PACK
- ORDER NO P.03
- WITH 100'S OF DIFFERENT PICTURES TO CHOOSE FROM THIS PACK IS AN ABSOLUTE MUST FOR ALL YOU DTP AND D.PAINT ENTHUSIASTS.
- 15 DISKS FOR ONLY £14.50+ P+P

WE OFFER A FAST AND VERY FRIENDLY SERVICE TO ALL OUR CUSTOMERS WITH THOUSANDS OF TITLES TO CHOOSE FROM. PLEASE SEND A S.A.E FOR A FREE CATALOGUE.

SEND YOUR ORDER TO:

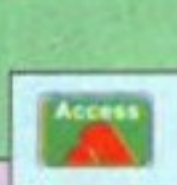

ASSASSIN'S GAMES PACKS 1-77 NOW IN STOCK

WE ACCEPT ACCESS, VISA AND MASTERCARD



DISCOVERY DEPT (AMF), 108 THE AVENUE, CLAYTON, SUSSEX TN11 9JX

KICK 1.3

NOW ALL P.D DISKS WILL WORK ON YOUR A500+/A600 & A1200 WITH THIS AMAZING DISK

ONLY £1.50

SWEDISH PD LIBRARY
SOFTLER SOFTWARE
 All prices are in SEK
 Box 242 S-124 02 Bandhagen tel. int. +46- (0)8-749 08 06
From SEK 13:-

Beställ 17 Bit diskar från oss!

Den enda officiellt godkända leverantören av 17 Bit diskar i Skandinavien
 Forutom alla 17 Bit diskar, över 2600, har vi ca 3500 andra diskar!!!

1 till 3 diskar.....23kr/st
 3 till 10 diskar.....20kr/st
 11 till 20 diskar.....18kr/st
 21 och fler.....17kr/st
 Fred Fish.....14kr/st
 Minst 11 Fish 13kr/st
 Moms och porto ingår.
 Ej kommersiella titlar.
 Ring 08-749 08 06 for info

Endast för AGA

DD.598 Renderade HAM8 bilder.
 DD.759 HAM8 svenska sedlar
 DD.760 Fish (från A1200 reklam) mfl.
 DD.791 Cynostic HAM8 slideshow
 DD.831 HOI 'Mindwarp' AGA demo
 DD.832 Trojan 'Techno Tracks' demo
 DD.833 Dual Crew multitask. demo
 SR.530 Tetris AGA & GIF datayp
 SR.612 AGA Utilities (PCX datatyp)
 SR.622 Ultimate AGA Utilities
 SR.801-802 Motorola Invaders- shoot
 'em up för AGA, 2 diskar

SR.613 PC Emulator nu med VGA!
 SR.614 ZX Spectrum Emulator 1.7
 SR.615 XFH Stackar - fördubblar HD
 SR.616 Hyper Cache - försnabbar HD
 SR.621 OptiMOD - förminskar moduler
 SR.624 Eagle Player - superb!!!
 SR.625 Disksalv 2 - diskräddning
 SR.627 Delitracker - moduluppspelare
 SR.628 OctaMED 2.0 - 8 ljudkanaler!
 SR.629 OctaMED moduler
 Techno moduler - fem diskar / 85:- kr.

Vi har över 6000 PD diskar!
Diskatalog 30:-
 på 4 diskar, inkl. 17Bits PD

CDPD

för CDTV/A570
 - CDPD 1 Fred Fish 1-660
 - CDPD 2 flera Fish, Scope mm
 - CDPD 3 Fish 761-880 mm.
 - Demo Collection
 - Demo Collection 2
325:-/st
 - 17 Bit Collection
 Över 1 GB av spel, demos mm.
565:-/dubbel CD

Kommer inom kort - Pandora's CD
 Giga PD och Aminet CD- ring för info!

**Assassins Games
 Nu diskar 1-95!**

Garanterat det bästa urvalet av PD
 spel som finns! Stora mängdrabatter!
 Pris från 11:-/ disk!
 Kontakta oss för detaljer...

**Betala på PostGiro nr
 426 99 36-3**

Moms och frakt ingår. Inget tillkommer
 vid PG inbetalning. Vid telefonbeställning
 tillkommer 22kr i postförskottsavgift
ÖVRIGA SKANDINAVIEN:
 Var god betala 15% extra per order, min.
 SEK 30 :-, tack. Betalning endast i SEK.

- | | |
|---|---|
| 1. Protacker V3 (P) (New Update) | 51. A500+ 21 Games (P) |
| 2. Hard Drive Utilities (2) (P) | 52. Assassins Games (1-99) (99) (P) |
| 3. Opticom V2.2 (NCom V2 etc) (P) | 53. Classic Games Pack (5) (P) |
| 4. Sid V2 (P) | 54. Cash Fruit (P) |
| 5. Messysid V2 (P) | 55. Super Skoda Challenge (P) |
| 6. How to Code in C (2) NEW | 56. Relayer (New Game) (P) |
| 7. Order V1.7 (P) (database Prog) | 57. Bomb Jacky (new) (P) |
| 8. Astronomy Pack 1 (4) (P) | 58. Dodgem (NEW) |
| 9. Alcatraz Odyssey (5) (P) | 59. Tennis Game 1 Meg (P) |
| 10. Amateur Radio 1-25 (25) (P) | 60. AGA Landscapes A1200 only |
| 11. C Manuals V3 (12) (P) | 61. Neighbours Game (2) (P) |
| 12. North C V1.3 (2) (P) | 62. WS Slide Shows (6) A1200 only |
| 13. Pool Wizard JNR (P) NEW | 63. Grapevine Issue 16 (3) (P) |
| 14. Amos Pro Update V1,12 | 64. Act of War (P) |
| 15. PC Pask V2.03 | 65. LSD Jesus on E (2) (20) (P) 100% |
| 16. Rattle Copy V5 Pro (P) | 66. Night Breed Slide Show (2) A1200 only |
| 17. ICPUG Printer Utils (3) (P) | 67. Giddy (P) |
| 18. Virus Checker V6.22 (P) | 68. Kesrens Desert Dreams (2) (P) NEW |
| 19. The Science Collection (4) (P) | 69. Lethal Exit (P) (NEW) |
| 20. Spectrum Datadisk (3) | 70. Speed Limit anim (3) (3 Meg) (P) |
| 21. Spectrum Emulator V1.7 (P) | 71. State Of The Art (P) |
| 22. A64 Emulator V2 (2) (P) | 72. Station at Kern (3) (2 Meg) (P) |
| 23. A64 Game disk 1+2 (2) | 73. HOI A1200 Demo |
| 24. Road Hog Anim (2) 2 Meg | 74. Tetris Game (new) (A1200 only) |
| 25. Kick 1.3 Emulator (WB2+) | 75. Revelations Slide Show (P) |
| 26. Action Replay V1.5 (P) | 76. The Shamen Forever People Remix |
| 27. World Geography (P) | 77. Action Replay Mark 4 A1200 only |
| 28. Education Pack 1 (5) (P) | 78. Exotic Ripper V2.10 (P) (new update) |
| 29. Exotic Creatures A1200 only | 79. Hackers & Hacking (P) |
| 30. Code Mongus (P) NEW | 80. Crack and Copy Utils (P) |
| 31. Fake Fast Ram Emulator (P) (NEW) | 81. Digital Issue 1 (P) |
| 32. Skick Multi Kickstart Emulator 1.3-v3 | 82. Lammings Revenge (2) 2 Meg |
| 33. A1200 Fix Program (A1200 only) | 83. Mindwarp (A1200 Only) |
| 34. Freepaint (P) | 84. Cynostic Slideshow (A1200 only) |
| 35. Graphic Construction Kit | 85. Scoopex Plays 2 Unlimited (2) (P) |
| 36. Blade Utility (P) | 86. Windblend A1200 only |
| 37. The Money Program (P) | 87. Wicked Sensation (2) (P) |
| 38. Rodbench V1.4 (Workbench 2+) | 88. Hullination X Dreams (2) (NP) |
| 39. Easy Spell 2 (P) | 89. A1200 Program Selector |
| 40. Kids Education (3) (P) | 90. A1200 Workbench Hacks |
| 41. Xi Software Sampler (P) | 91. A1200 AGA Screens |
| 42. Srupe Sampler (P) | 92. Sanity World of Commorde 92 (P) |
| 43. Assassins Handy Tools 3 (P) | 93. Kefrens Dance (P) |
| 44. Battle Cars 2 (P) | 94. Demon Download (2) (P) |
| 45. Space Invasion (P) NEW | 95. Alien Art (2) |
| 46. Premier Pic (P) | 96. Melon How to Skin a Cat (P) |
| 47. Hotseat Football Management (P) (NEW) | 97. Alchemy Rage (2) (P) |
| 48. TV Pkys (2) A1200 only. | 98. AGA Nation Slideshow (2) A1200 Only. |
| 49. Card Games (2) (P) | 99. A1200 Hardrive Prep. |
| 50. Supertron (P) | 100. Technologica Death (P) |



**EXPRESS P.D., Dept AF,
 47 ABERDALE ROAD,
 WEST KNIGHTON,
 LEICESTER LE2 6GD.
 Tel: (0533) 887061**

All P.D. is £1.05 per disk. Buy 12+ get 2 disks free and receive free Catalogue Disk (2). Includes 3 Games, 3 Virus Killers, Charly Music Demo and complete listing of Graphics, Music, Demo Business, Utilities, DIY, T-Bag (1-63), Fred-Fish (1-810), Amos, Amisus (1-22), Scope (1-220). Please add 60p to order from U.K., rest of Europe £2.50, rest of the world £3.00 for P&P.

ALL OUR DISKS:

- Guaranteed error free!
- Complete with own labels!
- Virus free!!
- 24 hours despatch!!

**Serious Solitaire
 1&2 £10 each**
**Serious
 Backgammon
 £19.99**

SEASOFT

The Logical Choice

NEW - OctaMED Pro V5 - £30.00

Brilliant new version of this famous 8 channel music editor with a totally new look -
 PULL DOWN MENUS, ON-LINE HELP, FULL MIDI SUPPORT WITH UP TO 64 TRACKS, SAMPLER EDITOR, DISPLAYS
 STANDARD TRACKER OR TRADITIONAL STAVE NOTATION etc., etc. (Requires Kickstart 2 or later)

AM/FM
 disk based
 magazine for
 Amiga Musicians
 Issue 15 now out
£2.50
 (1-14 also available)

A-GENE
 The latest version (V4.38)
 of this excellent
 genealogical database
£15.00

**ACC
 HARDWARE
 PROGRAMMING
 MANUAL**
 Disk 1 (PD) £1.50
 Disks 2-4
£12.50 the set

C.L.R. LICENCEWARE

1 disk titles £3.50, 2 disk titles £4.50, 3 disk titles £4.99
 (No. of disks shown in brackets)

AMFC
 Converts many standard
 music files to OctaMED
 format
£10.00

EDUCATIONAL ENCYCLOPEDIAS

The following disk based encyclopedias cover a range of
 interesting subjects. Using text, diagrams, drawings &
 photographs each title is entertaining as well as educational.

OUR TOP 20 P.D. TITLES

AM/FM
 high quality samples
 ideal for OctaMED etc.
 disk 15 now out
£2.50
 (1-14 also available)

**ACC
 AMIGA CODERS CLUB**
 hints, tips & tutorials for all
 assembly language
 programmers
£3.50 per issue
 (issues 5 - 31 available)

V-MORPH (1) - create smooth morphs and warps
 KICKSTART 2 (1) - run Dos 2 progs on your 1.3 Amiga
 NUMPAD (1) - adds numeric keypad to an A600
 KICK 1.3 (1) - run old A500 progs on A600 and A1200
 HOI AGA DEMO (1) - brilliant A1200 only demo
 PC TASK V2 (1) - latest PC emulator
 AGA TETRIS (1) - classic game & AGA utilities
 UCHESS (1) - ultimate AGA chess prog. (needs 4 Meg)
 A-BASE (1) - best shareware database around
 SID 2 (1) - latest version of this classic directory utility

AMIGA FOX (1) - desk top publishing on a budget
 D-COPY 2 (1) - disk copying prog with many features
 TEXT PLUS 3 (1) - excellent word processor
 M-CAD (1) - simple CAD package
 EASY CALC (1) - good spreadsheet program
 CHECK BOOK ACCOUNTANT (1) - banking program
 OctaMED V5 (1) - non save demo (not V1.3 machines)
 NORTH C (2) - classic C compiler
 ACC 1.4 (1) - issues 1-4 of Amiga Coders Club
 NCOMM (1) - powerful comms package

**FRED FISH
 1 TO 900**

**T-BAG
 1 TO 77**

CATALOGUE DISK - £1.25 (inc p & p) - FREE ! with your first order
 P.D. PRICES (per disk) 1-4 £1.50, 5-9 £1.25, 10-24 £1.00
 Unless otherwise stated all titles work on
 A500, A500+, A600 & A1200
 Please add 50p to all orders for P&P.

SEASOFT COMPUTING
 (Dept AF), The Business Centre
 First Floor, 80 Woodlands Avenue
 Rustington, West Sussex BN16 3EY
Tel - (0903) 850378
 9.30am to 7.00pm Mon-Fri (to 5pm Sat)

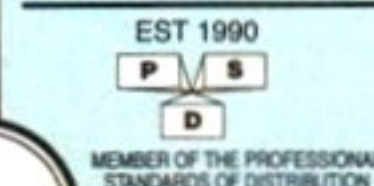

3.5" DSDD DISKS 35p EACH
 QTY'S 100+
QTY'S BELOW 100 @ 37p EACH
 100% GUARANTEED INCLUDES LABELS AND VAT

100 CAPACITY DISK BOX 3.5"	£4.75	PYTHON 1M JOYSTICK	£9.95
50 CAPACITY DISK BOX 3.5"	£3.50	MAVERICK 1M JOYSTICK	£12.95
QUALITY MOUSE MAT	£2.50	COMP PRO. STAR J/STICK	£13.95
ROBOSHIFT MSE/JST SWITCH	£12.95	COMP PRO. EXTRA J/STICK	£13.95
3.5" CLEANING KIT	£1.95	CRUISER BLACK J/STICK	£10.95
AMIGA MOUSE (350 DPI)	£12.95	CRUISER MULTI J/STICK	£10.95
AMIGA EXTERNAL DRIVE	£52.95	SPEEDKING A/F J/STICK	£10.95
A500 0.5MB RAM UPGRADE	£19.95	STARFIGHTER 3 PAD	£12.95
A500+ 1MB RAM UPGRADE	£34.95	ZIPSTICK A/F JOYSTICK	£12.95
A600 1MB UPGRADE	£39.95	S/KING ANALOGUE J/STICK	£12.95

SPECIAL OFFER
200 x 3.5" DSDD DISKS £76.95
PLUS 2 x 100 CAPACITY BOXES

A500 DUST COVER	£3.50	STAR LC10/20 BALCK	£2.25	COL. £5.95
A600 DUST COVER	£3.50	SATR LC200 BLACK	£2.95	COL. £7.95
A1200 DUST COVER	£3.50	STAR LC 24-10/200 BL.	£2.95	COL. £8.95
ROLL 200 LABELS	£1.95	CITIZEN 120D BLACK	£2.75	
ROLL 100 LABELS	£7.95	CITIZEN SWIFT 9/24 BLACK	£2.75	
T. FEED LABELS 1000	£9.95	CITIZEN SWIFT 9/24	£8.95	

3.5" HIGH DENSITY DISKS 58p for 100+ 60p BELOW 100

CHEQUES P/O'S TO:-
MICROMANIA DEPT AFT
 74 OLDBURY ROAD
 ROWLEY REGIS, WARLEY
 WEST MIDLANDS B65 0JS
PLEASE ADD £3.50 P&P PER ORDER
ORDER HOTLINE
021 559 1002
 CALLERS WELCOME AT OUR SHOWROOM



WE STOCK THE LOT
FISH TO 850!
AMOS DISKS!
TBAG DISKS!
NZ DISKS!
AMICUS!
AMIGAN!
ALL CLR TITLES

FOR THE BEST
IN QUALITY
AMIGA PUBLIC
DOMAIN,
NO-ONE ELSE
COMES CLOSE!

DEALERS WANTED!
IF YOU RUN A PD
OUTLET OVERSEAS
AND WOULD LIKE TO
DISTRIBUTE 17 BIT
DISKS, CALL US OR
FAX US NOW FOR
DETAILS!!

FAST SAME DAY SERVICE, HELPFUL SALES STAFF, ESTABLISHED FOR OVER 5 YEARS
40,000 MEMBERS THROUGHOUT THE WORLD, WELL OVER 4000 TITLES IN STOCK!

ORDERING

BY PHONE
(0924) 366982
 Access/Visa
 Switch/AMEX

BY FAX
(0924) 200943
 Leave Order &
 Card Details.

BY POST
 Our Address is:
 17 BIT SOFTWARE
 1st Floor Offices
 2/8 Market St.
 Wakefield,
 West Yorks
 WF1 1DH.
 Please Make All
 Cheques & PO's
 Payable to
 17 Bit Software

DISK PRICES
 17 BIT, FISH ETC...£1.25
 SCHEME 17£2.00
 AM/FM MAG£2.50
 AM/FM SAMPLES...£2.50
 CLR SINGLE£3.50
 CLR 2 DISK SET£4.50
 CLR 3 DISK SET£4.99
 CAT DISKS50P

POSTAGE RATES
 UK PD ORDERS.....50P
 OVERSEAS20%
 (MIN OVERSEAS ...1.00)
 PLEASE ADD 75P P&P
 FOR COMMERCIAL
 GAMES, DISK BOXES
 ETC.

We also stock
most new Amiga
games at over
20% Discount !!
Call for details

NEW PD ADDITIONS

- +2710 Spectrum Emulator V1.7
- +2709 Magic Factory Slideshow
- +2708 Super Pong
- +2707 Numtris
- +2706 Viewtek v1.5
- +2705 RD Prep
- +2704 HotBlox
- +2703 Reversi II
- +2702 Pools Wizard Jrn
- +2710 Entity
- +2699 PP Mini Cruncher
- +2698 HD Click V2.53
- +2697 Space Invasion
- +2696 Friends Of Paula Music
- +2695 Akira Pics #2
- +2694 "No Sampler?" Utils
- +2693 Nostromo Cheats V1.1
- +2692 Road To Hell Game
- +2691 Schmegeggi Comic Strip
- +2690 Cover Up (Anim)
- +2689 DTV Utils
- +2688 Samples Unlimited #1
- +2687 Doo Doo The Return
- +2686 Alternate Reality Anim
- +2685 Music Base V1.0
- +2684 Circus Anim
- +2683 Sanity Interference
- +2682 Amos Pro Update 1.12
- +2681 Popeye C64 Conversion
- +2680 (ABC) Grapevine 16
- +2679 Lemmings 2 HD Installer
- +2678 Copiers Unlimited
- +2677 (AB) On The Green 1.5M Anim
- +2676 Communicate (Sign Language)
- +2675 (AB) Endless Melodies
- +2674 (ABC) James Bond 30th Aniv.
- +2673 Quantum
- +2672 Retina Euro 1 Demo
- +2671 Supertron
- +2670 Catalogue 3
- +2669 Strikeball Game
- +2668 (AB) Lex Goudsmith Tribute II
- +2667 Total Irrelevance 1
- +2666 Rhythmic Orgy
- +2665 Pacmans Return
- +2664 Phantomware Slides
- +2663 X-Beat Seqencer
- +2662 Lemmingoids 2
- +2661 Major League
- +2660 Fun With Cubby Demo
- +2659 Red Dwarf Trivia Quiz
- +2658 (AB) Starbase 13 Game Mega
- +2657 Capri Slideshow II
- +2656 Total Irrelevance Iss #2
- +2655 Music Madness
- X2653 (AB) Fit Chicks
- +2652 Windybottom Demo
- +2651 (AB) Zynex 3 Anim
- +2650 Great Escape Of Billy Burglar
- +2649 CG FONTS #7
- +2648 CG FONTS #6
- +2647 CG FONTS #5
- +2646 Bondmine
- +2645 (AB) Start Of The Art Utils.

BITSES AND PIECES!

GRAPEVINE 16
 The Scene mag that needs NO
 introduction. £4.00 inc P&P

**BACK BY UNCEASING
 DEMAND!**
 Tobias J Richter presents Space
 Wars, The Movie on hi-grade VHS
 tape in Hi-Fi! This WILL be the
 VERY LAST production run so
BUY IT NOW!
 £11.99 +75p P+P

'SOUNDS DIGITAL'
 Alister Brimble presents his first
 ever Music CD. Includes the
 famous 'Rave Track' from Team 17
 Game Project X as well as other
 previously unheard synth tracks.
 Professionally recorded & studio
 quality, Sounds Digital is for
 anyone with a taste in Synth
 Music. £10.99 +75p P+P

FINAL FRONTIER 5
 Warp factor 4 Mr Sulu, and pass
 me my copy of T.E.F. while you're
 at it. Aye Cap'n but don't forget to
 pay £6.95 to
 Checkout...errr Checkov!

COMPUGRAPHIC PACK
 5 Disks including dozens of
 Compugraphic fonts for use in
 Final Copy, Pagesetter 3 or
 Propage V3+.
 £6.00 inc P+P

ASSASSINS GAMES DISKS
 Easily the most popular games
 compilations around today. We
 now stock the entire range up to
 disk 95! That's around 375 games!
 They are available as individual
 disks at £1.25 each or you can
 save by ordering in packs of the
 following:-
ANY 20 ASI DISKS FOR £20.00
ANY 40 ASI DISKS FOR £38.00
ANY 60 ASI DISKS FOR £56.00
ANY 80 ASI DISKS FOR £74.00
OR TAKE THE LOT FOR £90.00!

Subscribe to the 17 Bit Update! Every 8 weeks we will send a disk based
 update to you containing lists of all the latest in PD + other useful items!
 Subscription is £9.99 per year inclusive. Overseas subs are £19.99 inc.

AM/FM #14!
 Packed with the usual goodies,
 utils, articles and modules for
 Amiga music lovers! £2.50 or £4.00
 with samples!

A570 & CD USERS ...LOOK!

THE 17 BIT COLLECTION
 We are proud to present our own
 collection of over 1700 library
 disks compiled onto a double CD
 collection for all A570 & CDTV
 users. The disks contain the vast
 bulk of the 17 Bit library up to disk
 2301 which include classics such as
 Odyssey & Hardwired etc. Just
 some of the awards so far include:-
 98% - The One
 89% - Amiga Format
 90% - CU Amiga
 Buy yours now for £39.99 + £1 P+P

DEMO CD
 Over 650 megabytes of demos,
 cliparts, music, slideshows, games
 and utilities. Not to mention over
 1000 modules!
 £19.99 +75p P+P

CDPD VOLUME 1
 This packed CD contains the
 entire Fred Fish range of disks
 from 1 to 650!
 Only £19.99 +75p P+P

CDPD VOLUME 2
 The continuation of the Fred Fish
 range plus the entire SCOPE &
 JAM ranges of disks too!
 Unbeatable value at
 £19.99 + 75p P+P

NEW IN!! CDPD VOLUME 3
 Fish from F761 to F890, ready to
 run from the CD! Also includes
 dozens of high quality 24 bit scans
 plus Ham and AGA H8 versions
 & MUCH MORE!
 for only £19.99 + 75p P&P!



A VERY SPECIAL OFFER

NOVEMBER 1993

SAVE £23!

UPGRADE TO TURBOPRINT PROFESSIONAL 2

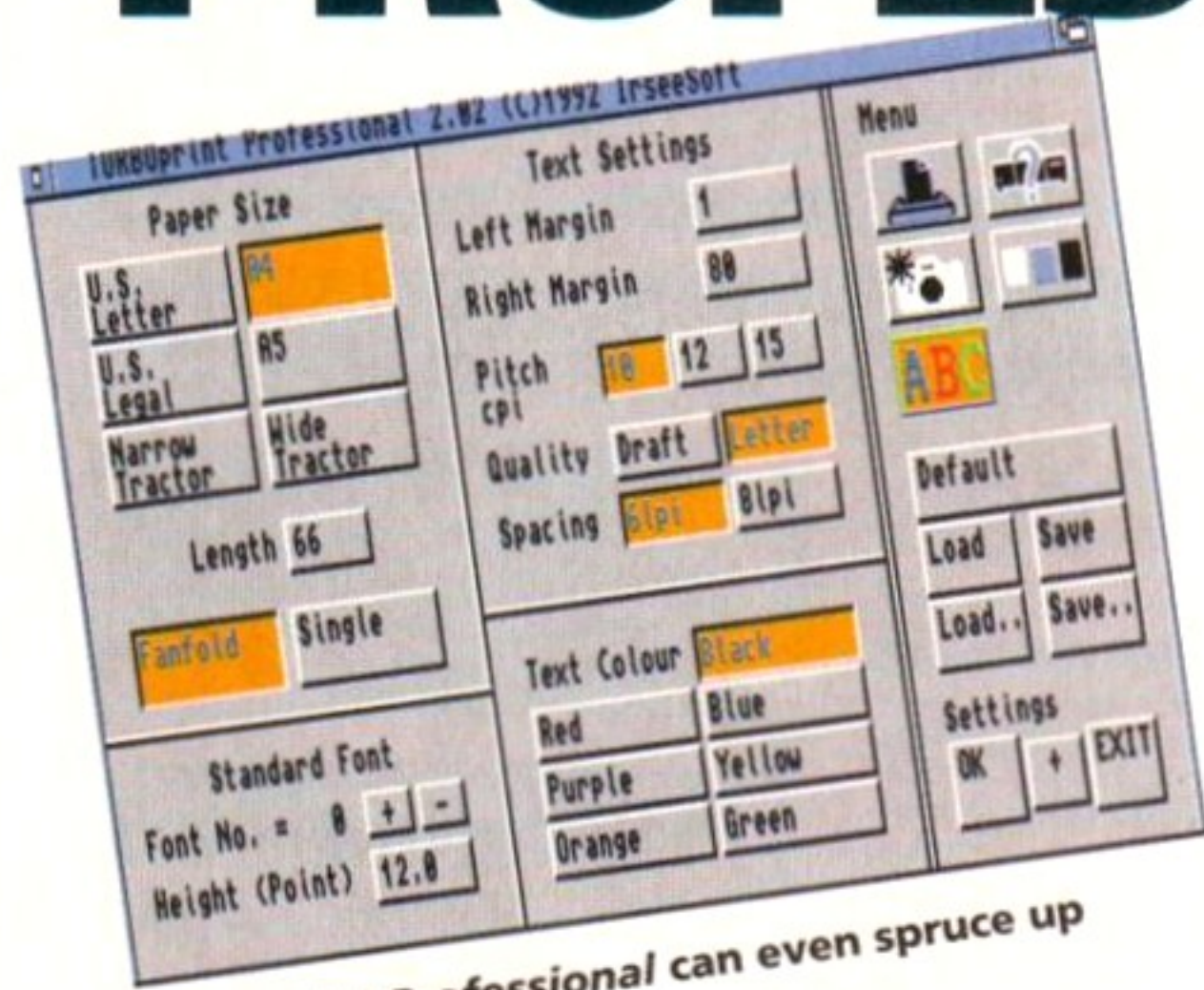

TurboPrint Professional can even spruce up everyday text dumps.

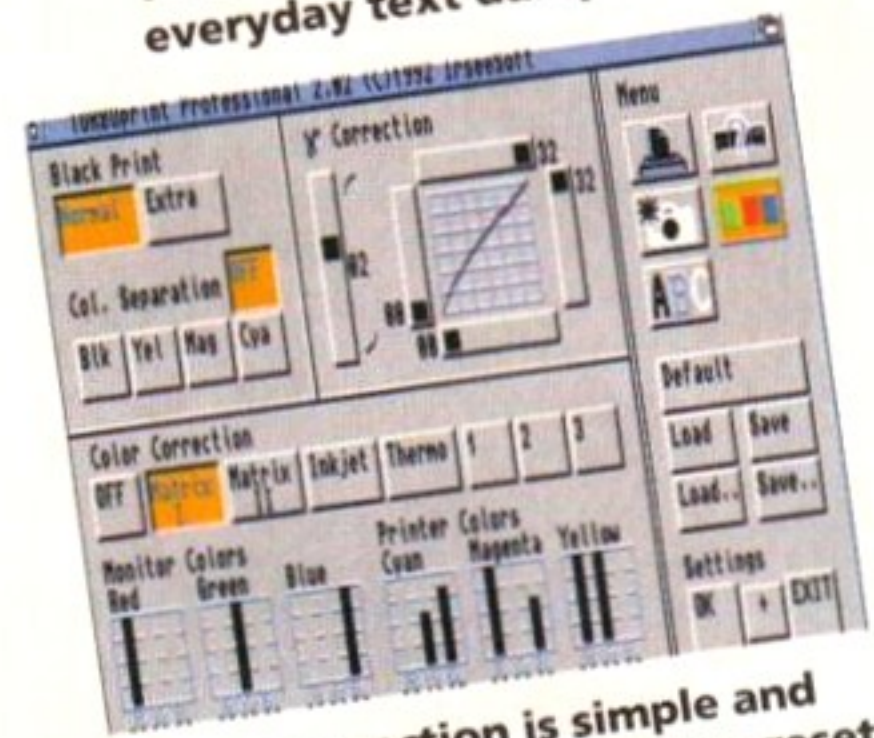

Colour correction is simple and effective. Choose from the preset values or adjust it yourself.

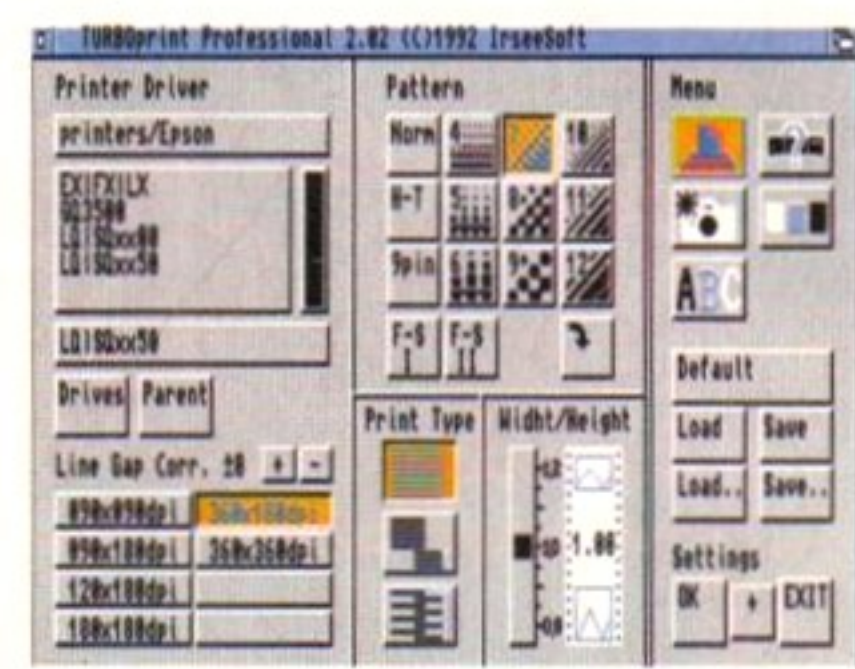

Choose from over 30 printer drivers and select a dither pattern.

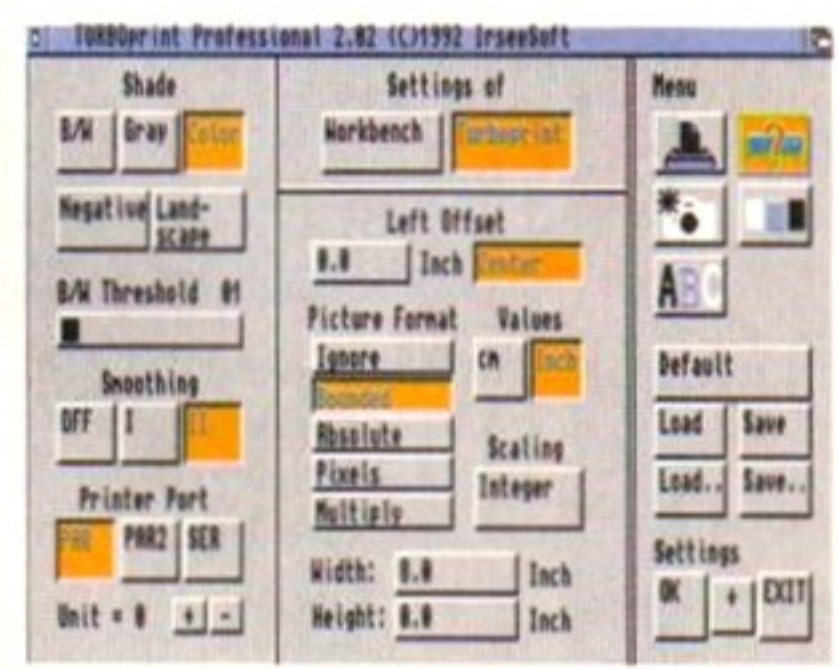

And you can set preference options from within TurboPrint Pro.



If you didn't buy last month's issue of AF, then you missed out on getting a free copy of TurboPrint 2. To order a back issue turn to page 168.

Improve the quality of your printing ...and save over £23!

YOU'VE SEEN HOW TurboPrint can improve your quality of life (and the quality of your print outs), just imagine how much happier your little plastic pal with a Centronics interface would be if you had the latest version, TurboPrint Professional.

Amongst its diverse weaponry for combating printout problems are gamma correction, colour correction, even more dithers, a cunning half-line mode and a lower pin operation mode.

In addition it provides a range of useful and powerful printout options including a 'mirror' option, and a multiple-paged tiled poster option, enabling your printer to create masterpieces up to eight pages high by eight pages wide.

The outstanding control offered on colour correction will allow the smallest of printer characteristics to be altered with a simple-to-use and easy-to-understand system of screen menus. But if you can't understand the menus straight away, don't worry - the program comes with a full and comprehensive 80 page manual detailing every aspect of TurboPrint Pro's operation.

All in all, it's pretty amazing - but possibly the most amazing thing is that the full software, drivers and manuals have a recommended retail price of just £49.95. But if you order now using the form on the left, you can get your ink-stained hands on the whole lot for just £26.95! Just make out a cheque to Future Publishing Limited and send it to: TurboPrint Offer, Amiga Format, Future Publishing Limited, Cary Court, Somerton, Somerset TA11 6TB.

DRIVERS

TurboPrint Pro directly supports and is supplied with printer drivers for all the following machines:

- BROTHER**
Brother24.m
Brother9.m
- CANON**
BJ-130_180x180dpi
BJ-130_180x360dpi
BJ-130_360x180dpi
BJ-130_360x360dpi
LBP-4,8III_075x075dpi
LBP-4,8III_100x100dpi
LBP-4,8III_150x150dpi
LBP-4,8III_300x300dpi
LBP-4,8_075x075dpi
LBP-4,8_100x100dpi
LBP-4,8_150x150dpi
LBP-4,8_300x300dpi
LBP-8II_075x075dpi
LBP-8II_100x100dpi
LBP-8II_150x150dpi
LBP-8II_300x300dpi
PJ-1080A_080x080dpi
- EPSON**
EXIFXILX.m
GQ3500_100x100dpi
GQ3500_150x150dpi
GQ3500_300x300dpi
LQISQxx00.m
LQISQxx50.m
- FACIT**
B3450.m
B3550.m
- HP**
DeskJet.m
Deskjet500.m
Deskjet500C.m
Deskjet550C.m
DJ500C.m
DJ550C.m
LaserJetIII.m
LaserJetIII.m
PaintJetXL_090x090dpi
PaintJetXL_180x180dpi
PaintJet_090x090dpi
PaintJet_180x180dpi
- NEC**
Pinwriter Px.m
Px.m
- OKI**
ML294_120x072dpi
ML294_120x144dpi
ML38x.m
ML39x.m
Okimate20std_120x166dpi
Okimate20std_120x174dpi
Okimate20_120x144+dpi
Okimate20_120x144dpi
- PANASONIC**
KX-P1124.m
KX-P1540.m
KX-P4450.m
- SEIKOSHA**
1300,5350.m
MP-1300,5350AI.m
OP-105.m
SL-80AI.m
SL-80IP.m
SL-92.m
SP-2000.m
- SIEMENS**
HiPr4x00.m
PT88,89_060x072dpi
PT88,89_120x072dpi
PT88,89_120x144dpi
PT90_060x060dpi
PT90_120x120dpi
PT90_240x240dpi
- STAR**
LaserPrinter 8.m
LC-10.m
LCIXB-24.m
LP8.m
NB24.m
- CITIZEN**
120D+.m
120D.m
Swift24.m
Swift9.m
- FUJITSU**
DL-1100(LQ2550).m

Please send me my most excellent copy of TurboPrint Professional 2. I enclose a cheque for £26.95 made payable to: **FUTURE PUBLISHING LIMITED**

Name _____
 Address _____

 Post Code _____ Phone Number _____

METHOD OF PAYMENT: (Tick as appropriate)

card no.

expiry date cheque Access Visa postal order

ORDER CODE: AMF263

SEIKOSHA - QUALITY PRINTERS

Silica Systems are pleased to recommend the high quality range of Seikosha printers. Built to the highest standards by a company that is used to manufacturing quality precision products. Seikosha are part of the massive Seiko/Epson group with a turnover of £6 billion and 18,000 staff! Every dot matrix printer from Silica comes with a free printer starter kit which includes all you need to get up and running with your new Seikosha printer (see below).

FROM ONLY

£109

EXC VAT

FREE! FROM SILICA

- DELIVERY** Next day - anywhere in the UK mainland.
- HELPLINE** Technical helpline during office hours.
- AMIGA DRIVER** Seikosha Plus Printer Driver with every SL-95. For extra high quality output. Features include:
 - Definable Dither Routines
 - 16-point Colour Adjustment
 - Ink Compensation Correction
 - Workbench 2/3 GUI
 - Prints up to 256 Shades of Grey
 - Enhanced Print Speeds
 - Full Control of Printer Typefaces
 - Graphics/Paper Size, Margins
- STARTER KIT** With every Seikosha dot matrix printer



FREE! FROM SILICA WORTH £29.38

Every Seikosha dot matrix printer from Silica comes with a FREE Starter Kit, worth £29.38 (£25.00+VAT).

- 3 1/2" Disk with Amiga & ST Printer Drivers
- 1.8 Metre Parallel Printer Cable
- 200 Sheets of Quality Continuous Paper
- 100 Continuous Tractor Feed Address Labels
- 5 Continuous Envelopes on Tractor Feed

9-PIN 80 COLUMN 192CPS



ON-SITE WARRANTY 1 YR - ONLY £10.00 - POS 8515

- Seikosha SP-1900 Plus
- 9-Pin Dot Matrix
- 80 Column
- 192cps Draft, 48cps NLQ
- 1K Printer Buffer + 2 Fonts
- Parallel Interface
- Graphics Resolution: 144 x 72dpi
- Epson and IBM Emulation
- Auto Sheet Feeder Option
- Friction Feed and Push Tractor - Auto Paper Load, Paper Parking
- FREE Silica Printer Starter Kit

PRINTER RRP £149
STARTER KIT £25
TOTAL VALUE: £174
SAVING: £65
SILICA PRICE: £109
£109
+ VAT = £128.08 PPI 8195

9-PIN 80 COLUMN 300CPS



ON-SITE WARRANTY 1 YR - ONLY £10.00 - POS 8515

- Seikosha SP-2400
- 9-Pin Dot Matrix
- 80 Column
- 300cps SD, 240cps D, 60cps NLQ
- 21K Printer Buffer + 5 Fonts
- Parallel and Serial Interfaces
- Graphics Resolution: 240 x 144dpi
- Epson and IBM Emulation
- Friction Feed and Push Tractor
- Paper Parking Standard
- Optional Auto Sheet Feeder Unit
- FREE Silica Printer Starter Kit

PRINTER RRP £185
STARTER KIT £25
TOTAL VALUE: £210
SAVING: £71
SILICA PRICE: £139
£139
+ VAT = £163.33 PPI 8204

24-PIN 80 COLUMN 240CPS



ON-SITE WARRANTY 1 YR - ONLY £10.00 - POS 8515

- Seikosha SL-90
- 24-Pin Dot Matrix
- 80 Column
- 240cps SD, 192cps D, 84cps LQ
- 20K Buffer + 2 Fonts
- Optional Font ROM
- Parallel Interface
- Graphics Resolution: 360 x 360dpi
- Epson LQ850 Emulation
- Built-In Semi-Automatic Cut Sheet Feeder - Paper Parking, Auto Paper Load - Optional Automatic CSF
- FREE Silica Printer Starter Kit

PRINTER RRP £199
STARTER KIT £25
TOTAL VALUE: £224
SAVING: £65
SILICA PRICE: £159
£159
+ VAT = £186.83 PPI 8290

24-PIN COLOUR DOT MATRIX



SAVE £70 OFF RRP £249 **£179**

FREE! STARTER KIT & DELIVERY SEE ABOVE

COLOUR

ON-SITE WARRANTY 1 YR - ONLY £10.00 - POS 8515

FREE! SEIKOSHA PLUS AMIGA PRINTER DRIVER

- Seikosha SL-95 - 24 pin - Dot Matrix
- 240cps SDraft, 192cps Draft, 64cps LQ
- 43K Printer Buffer + 9 Fonts
- Parallel Interface
- Graphics Resolution: 360 x 360 dpi
- Epson LQ860/850/2500/2550 Emulation
- Colour Printing as Standard (Includes Colour Ribbon - Black Ribbon Optional Extra)
- Semi Auto Single Sheet Feeder
- Optional Auto Cut Sheet Feeder
- FREE Silica Printer Starter Kit

PRINTER RRP £249
STARTER KIT £25
TOTAL VALUE: £274
SAVING: £95
SILICA PRICE: £179
£179
+ VAT = £210.33 PPI 8303

FAST 128 NOZZLE INKJET



LATEST TECHNOLOGY! 128 NOZZLES ULTRA FAST 300CPS LQ

SAVE £80 OFF RRP £359 **£279**

FREE CABLE & DELIVERY

ON-SITE WARRANTY 1 YR - £24.63 - POS 8522

BUILT-IN AUTO SHEET FEEDER

- SpeedJET 300 - Inkjet Printer
- High Capacity 128 Nozzle Inkjet Head
- Large Ink Tank - up to 4.2 Million Characters
- 300 CPS Draft (10cpi) - 300 CPS LQ (10cpi)
- 24K Printer Buffer - 3 Built-in Fonts
- 2 IC Card Slots for Buffer Expansion + Fonts
- Parallel I/F - Graphics Res. 300 x 300dpi
- HP Deskjet Emulation (PCL3)
- Built-in Auto Sheet Feeder (100 Sheets)
- Economical to Run - only 1.3p per page
- Ultra Quiet - 46dB(A) Maximum

PRINTER RRP £359
TOTAL VALUE: £359
SAVING: £80
SILICA PRICE: £279
£279
+ VAT = £327.83 PPI 8030

4PPM LASER



LASER STARTER KIT 1.8m PC PARALLEL CABLE, PAPER, LABELS, ENVELOPES RRP £29.38 SILICA ONLY **£14.69** INC VAT

FREE DELIVERY

SAVE £450 OFF RRP £899 **£449**

4 PPM 300 DPI

- OP-104 - 4 Pages per minute
- HP LaserJet IIP™ Emulation
- Resolution: 300x300dpi - 14 Resident Fonts
- Uses Original HP® Font Cards
- Postscript Emulation Option (Extra)
- Optional IBM, Epson & Diablo Emulation Cartridges
- Centronics Parallel & RS232C/RS422 Serial Interfaces
- 512K RAM - expandable to 2.5Mb
- Flexible paper handling: Standard paper cassette - 100 sheets, Optional 2nd bin - 300 sheets
- Quiet Operation 46dB(A)
- Compact Design with Straight Paper Path
- Cable required: CAB 7500 for PC - £9.95 or CAB 7614 for ST/Amiga - £12.95

PRINTER RRP £899
TOTAL VALUE: £899
SAVING: £450
SILICA PRICE: £449
£449
+ VAT = £527.58 LAS 8004

SILICA SYSTEMS OFFER YOU

- FREE OVERNIGHT DELIVERY:** On all hardware orders shipped in the UK mainland.
- TECHNICAL SUPPORT HELPLINE:** Team of technical experts at your service.
- PRICE MATCH:** We normally match competitors on a "Same product - Same price" basis.
- ESTABLISHED 14 YEARS:** Proven track record in professional computer sales.
- £12 MILLION TURNOVER (with 60 staff):** Solid, reliable and profitable.
- BUSINESS + EDUCATION + GOVERNMENT:** Volume discounts available 081-308 0888.
- SHOWROOMS:** Demonstration and training facilities at all our stores.
- THE FULL STOCK RANGE:** All of your requirements from one supplier.
- FREE CATALOGUES:** Will be mailed to you with offers + software and peripheral details.
- PAYMENT:** Major credit cards, cash, cheque or monthly terms (APR 29.8% - written quotes on request).

Before you decide when to buy your new printer, we suggest you think very carefully about WHERE you buy it. Consider what it will be like a few months after you have made your purchase, when you may require additional peripherals and accessories, or help and advice. And, will the company you buy from contact you with details of new products? At Silica Systems, we ensure that you will have nothing to worry about. We have been established for almost 14 years and, with our unrivalled experience and expertise, we can now claim to meet our customers' requirements with an understanding which is second to none. But don't just take our word for it. Complete and return the coupon now for our latest FREE literature and begin to experience the "Silica Systems Service".

MAIL ORDER HOTLINE
081-309 1111



MAIL ORDER: Order Lines Open: Mon-Sat 9.00am-6.00pm No Late Night Opening	1-4 The Mews, Hatherley Rd, Sidcup, Kent, DA14 4DX	Tel: 081-309 1111 Fax No: 081-308 0808
LONDON SHOP: Opening Hours: Mon-Sat 9.30am-6.00pm No Late Night Opening	52 Tottenham Court Road, London, W1P 0BA	Tel: 071-580 4000 Fax No: 071-323 4737
LONDON SHOP: Opening Hours: Mon-Sat 9.30am-7.00pm Late Night: Thursday - 8pm	Selfridges (Basement Arena), Oxford Street, London, W1A 1AB	Tel: 071-629 1234 Extension: 3914
SIDCUP SHOP: Opening Hours: Mon-Sat 9.00am-5.30pm Late Night: Friday - 7pm	1-4 The Mews, Hatherley Rd, Sidcup, Kent, DA14 4DX	Tel: 081-302 8811 Fax No: 081-309 0017
ESSEX SHOP: Opening Hours: Mon-Fri 9.30am-5.30pm (Sat 9.00am-6.00pm) Late Night: Thursday - 7pm	Keddies (2nd Floor), High Street, Southend-on-Sea, Essex, SS1 1LA	Tel: 0702 468039 Fax No: 0702 468039

To: Silica Systems, AMFOR-1193-84, 1-4 The Mews, Hatherley Rd, Sidcup, Kent, DA14 4DX

PLEASE SEND A BROCHURE ON THE SEIKOSHA RANGE

Mr/Mrs/Ms: Initials: Surname: Date:

Company Name (if applicable):

Address:

Postcode:

Tel (Home): Tel (Work):

Which computer(s), if any, do you own?

DON'T MISS OUT!

Subscribing to Amiga Format you now get even more for your money:

- Two coverdisks each month
- One special subscribers' superdisk
- Backstage newsletter from behind the scenes
- Subscribers' superdisk instructions

That's three disks and four pages of extra information and disk instructions every month – what more could you ask for?

So don't miss out – get smart and subscribe now!



Back ISSUES



ISSUE 25
DTP explained, plus the massive round-up of the year.



ISSUE 27
True Colour brings 16 million colours to your screen.



ISSUE 29
First review of the A500 Plus, word processors tested.



ISSUE 33
Landscape program Vista, plus how to create cartoons.



ISSUE 35
Digitising and sampling. Plus Spectracolor Jr.



ISSUE 36
Multimedia: CanDo! Jr and the low-down on the A600 and the CD-ROM drive!



ISSUE 37
Musicians and artists who have made it big with an Amiga, plus Animation Station.



ISSUE 38
Got an A500? Learn how your machine can be a Super Amiga! Plus IntroCAD on Coverdisk.



ISSUE 39
Read the first part of Bullfrog's games programming guide. Plus Devpac2 on Coverdisk.



ISSUE 43
We take a look inside the Amiga and tell you 'How it Works'. On the Coverdisk the full database ProData.



ISSUE 44
The best software ever comes in for a good looking at, as does Deluxe Paint IV AGA, and Personal Paint.



ISSUE 45
Why the Amiga is the world's best multimedia computer. Get five free postcards and play Dong on the Coverdisk.



ISSUE 46
The weird world of Cyberpunk. Reviewed: Lemmings 2, Vista Pro 3 and Real 3D2. Full round-up of IDE drives.



ISSUE 47
A page-by-page guide to the World of Commodore; review of the new A4000/030 and two stonking game demos.



ISSUE 48
Eight page tutorial on creating your own PD demo; plus we give you all the software you'll need. Plus Amiga & video.



ISSUE 49
Amiga and 3D. Plus joystick and accelerator round-ups. Coverdisk: Stardust demo and 3D program, Genesis.



ISSUE 50
50 hottest Amiga products ever. Plus A1200 RAM expansions and AGA monitors tested. Coverdisk: Deluxe Music Construction Set2



ISSUE 51
Independent software houses: a look ahead. Coverdisks: Second Samurai, Turbo Print 2 and Skidmarks.

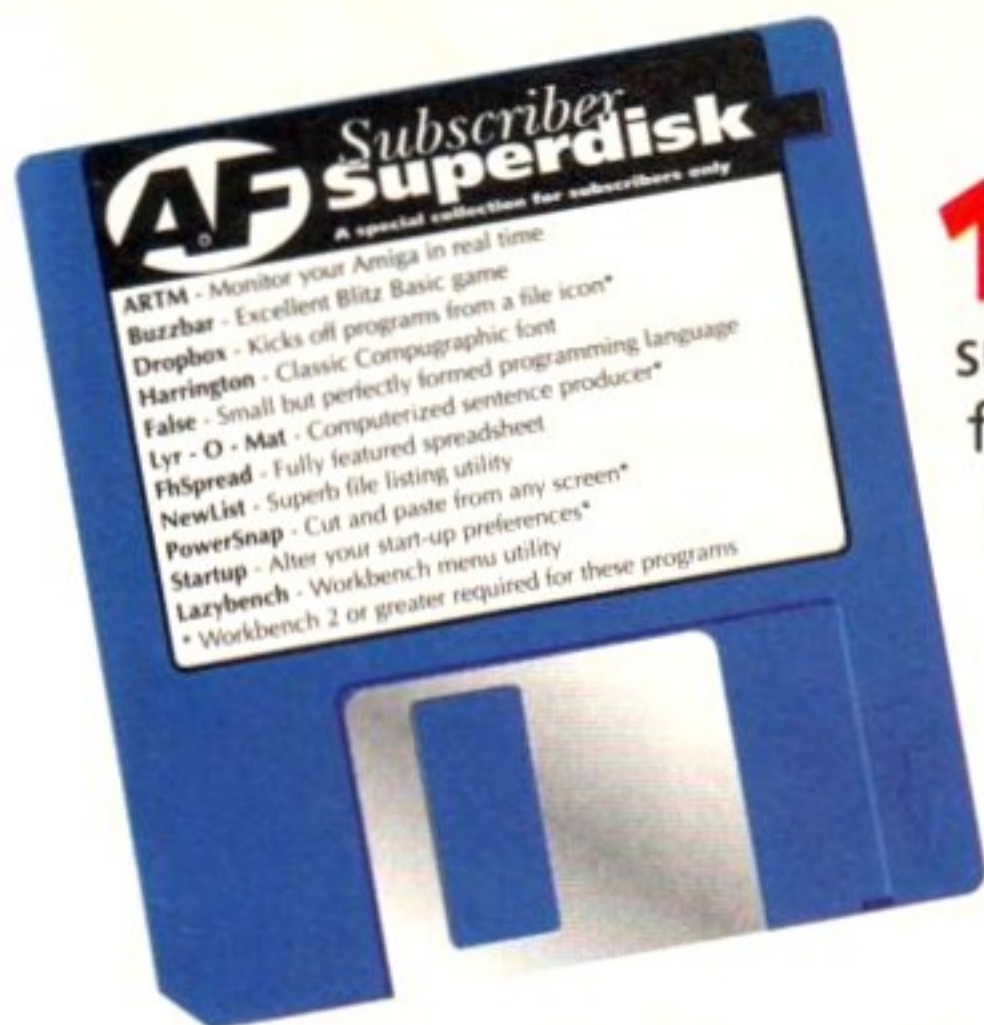

1 Extra disk – for Amiga Format subscribers only – full of utilities and games.

2 Pages of instructions for the subscribers' superdisk.



2 Pages of 'Backstage', our behind-the-scenes newsletter.



AMIGA FORMAT SUBSCRIPTIONS/BACK ISSUES ORDER FORM

Yes! please enter/renew my subscription to *Amiga Format* and send me the software of my choice: (please tick as appropriate)

UK £44.95 Europe £73.95
Rest of World £103.95

Please send me the following back issues:

<input type="checkbox"/>	<input type="checkbox"/>	<input type="checkbox"/>	<input type="checkbox"/>	<input type="checkbox"/>	<input type="checkbox"/>	<input type="checkbox"/>	<input type="checkbox"/>	<input type="checkbox"/>	<input type="checkbox"/>
<input type="checkbox"/>	<input type="checkbox"/>	<input type="checkbox"/>	<input type="checkbox"/>	<input type="checkbox"/>	<input type="checkbox"/>	<input type="checkbox"/>	<input type="checkbox"/>	<input type="checkbox"/>	<input type="checkbox"/>

Name _____

Address _____

Postcode _____

Telephone No. _____

Method of payment: please tick as appropriate

Access Visa Cheque Postal Order

Direct debit (subscriptions only)

Total amount payable: £ _____

Credit card No.

Expiry Date _____

Please make cheques payable to: **Future Publishing Ltd**

SEND THIS FORM TO: (NO STAMP NEEDED)

Amiga Format, Subscriptions/Back Issues, FREEPOST, Future Publishing Ltd, Cary Court, Somerton, Somerset, TA11 7BR

DIRECT DEBIT INSTRUCTIONS ID: 930763

This form instructs your bank or building society to make payments direct from your account. Please complete all five items and then send it to us at the address above.

(Banks and building societies may refuse to accept instructions to pay direct debits from some types of accounts.)

1. Please write the full address of your branch

To: The Manager
.....Bank/Building Soc.
.....
.....
.....
.....

2. Account number

3. Sort code

4. Account in name of:

.....
Instructions to bank/building society
- I instruct you to pay direct debits from my account at the request of Future Publishing Ltd.
- The amounts are variable and may be debited on various dates. I understand that Future Publishing Ltd may change the amounts and dates only after giving me prior notice.
- I will inform you in writing if I wish to cancel this instruction.
- I understand that if any direct debit is paid which breaks the terms of this instruction, you will make a refund.

5. Signed.....

Date.....

Treat yourself to something special...



ISSUE 1
The Complete Software Guide
More than 150 pages packed with software reviews.



ISSUE 2
The Amiga Format Annual 1993
Find out what goes on behind the scenes at Amiga Format.



ISSUE 3
The Complete Beginner's Guide
A look at the Amiga for those who are new to the machine.

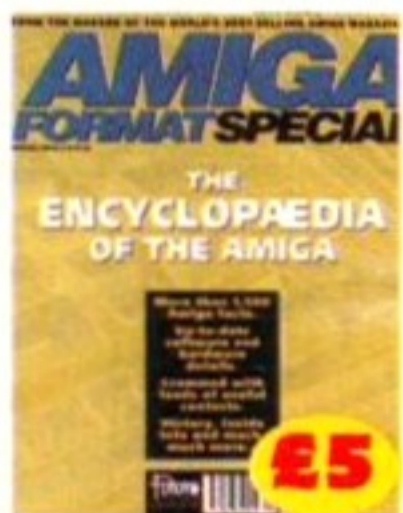

ISSUE 4
The Encyclopaedia of the Amiga
Everything you ever wanted to know about the Amiga in alphabetical order.

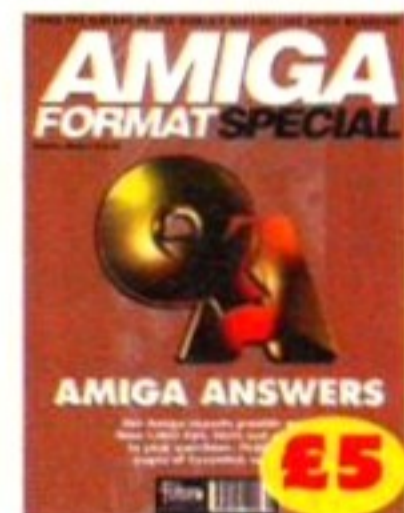

ISSUE 5
Questions & Answers
140 pages of all the Amiga related questions you could ever conceive of being answered.



ISSUE 6
Good Hardware Guide
Don't buy an add on until you've read this. From accelerators to video genlocks.

Premier Mail Order

E & OE

Titles marked * are not yet available and will be sent on day of release. Please send cheque/PO (made out to Premier Mail Order) / Access/Visa no. & expiry date to:

Dept AF52, 10 Tinkler Side, Basildon, Essex SS14 1LE Tel: 0268-271172 Fax: 0268-271173
Telephone orders: Mon-Fri 9am-7pm and Sat & Sun 10am-4pm. We are open 364 days a year.

P&P and VAT is included for all UK orders. Please add £2 P&P for Europe, elsewhere please add £3.50 per item for Airmail. Next day service available UK only £4.00 per item.

1869.....20.99	Cyberspace *.....22.99	Indiana Jones Fate of Atlantis Adv.....24.99	Premier Manager 2 *.....17.99	Theatre of Death.....19.99
1st Division Manager.....6.99	D Day.....22.99	International Open Golf Championship.....17.99	Prime Mover.....17.99	Toki.....8.99
3D Con Kit 2.....34.99	Dark Sun: Shattered Lands *.....21.99	International Rugby Challenge.....17.99	Prince Of Persia.....6.99	Tom Landry Strategy Football.....27.99
A - Train.....22.99	Darkmere *.....17.99	Ishar (A1200).....22.99	Pro Tennis Tour 2.....16.99	Tornado *.....22.99
A320 Airbus (Europe).....22.99	Deepcore.....17.99	Ishar 2.....17.99	Project X (enhanced).....10.99	Tracoon 2.....37.99
A320 Airbus (USA).....22.99	Deluxe Music Construction Set 2.0.....59.99	Jack Nicklaus Golf.....17.99	Prophecy.....19.99	Trolls.....16.99
AV8B Harrier Assault (1 Meg).....22.99	Deluxe Paint 4 AGA.....64.99	Jaguar XJ220 (1 Meg).....16.99	Putty (1 Meg).....16.99	Turbo Challenge.....8.99
Abandoned Places 2.....19.99	Dennis.....17.99	James Pond 3 (A1200).....19.99	Qwak.....9.99	Turbo Challenge 3 (1 Meg).....16.99
Air Bucks 1.2.....22.99	Desert Strike.....19.99	Jimmy Whites Snooker (See The Greatest).....16.99	RBI 2 Baseball.....6.99	Two-Light 2000.....20.99
Air Bucks 1.2 (A1200).....22.99	Diggers (A1200).....19.99	Jahn Madden American Football.....16.99	Ragnarok *.....22.99	U96 *.....22.99
Alien Chicken.....17.99	Disposable Hero.....17.99	Jurassic Park.....17.99	Rainbow Islands.....6.99	Universal Monsters.....17.99
Alien 3.....19.99	Dizzy Collection.....16.99	K240.....19.99	Reach for the Skies.....19.99	Utopia + Data Disk.....19.99
Alien Breed 2 *.....19.99	Dizzy's Excellent Adventure.....16.99	KGB (1 Meg).....20.99	Renegade 2 *.....16.99	WWF 1.....8.99
Alien Breed Special Edition.....10.99	Dooglight *.....22.99	Kings Quest V1.....26.99	Road Rash.....19.99	WWF 2.....17.99
Ambermoon *.....20.99	Dream Wet *.....22.99	Kit Viscious.....17.99	Rome AD 92.....16.99	Walker.....19.99
American Gladiators.....16.99	Dune 2.....20.99	Knighmare.....11.99	Rookies *.....16.99	War in the Gulf.....19.99
Amos 3D.....24.99	Dynablaster.....19.99	Legacy of Sarasil.....17.99	Ryder Cup.....17.99	Waxworks.....22.99
Amos Compiler.....19.99	Easy Amos.....29.99	Legends of Valour.....24.99	Scrabble.....18.99	Western Front *.....20.99
Amos Professional.....44.99	Entity.....19.99	Lemmings 2 The Tribes.....17.99	Sea Air Rescue *.....22.99	Whales Voyage.....16.99
Amos the Creator.....29.99	European Champions.....17.99	Lemmings Double Pack.....19.99	Second Samurai.....22.99	Winter Challenge *.....22.99
Ancient Art of War.....22.99	Exodus 3010 *.....19.99	Lionheart.....18.99	Call.....19.99	Worlds of Legend.....17.99
Apocalypse.....22.99	Eye of the Beholder (1 Meg).....19.99	Living Pinball.....19.99	Secret Monkey Island 2 (1 Meg).....24.99	Yo Joe.....17.99
Arabian Nights.....17.99	Eye of the Beholder 2 (1 Meg).....21.99	Lure of the Temptress (See The Greatest).....12.99	Sensible Soccer 92/93.....16.99	Zool 2 *.....17.99
Arabian Nights (A1200).....19.99	Eye of the Storm *.....19.99	M1 Tank Platoon.....12.99	Settlers.....19.99	Zool A1200.....16.99
Archer Maclean's Pool.....16.99	F1 Challenge.....17.99	Maelstrom.....22.99	Shadowlands.....8.99	
Arsenal FC *.....16.99	F117A Nighthawk Stealth Fighter.....22.99	Manchester United Europe.....8.99	Shoot Em Up Con Kit.....8.99	
Assassin Remix.....9.99	F15 Strike Eagle 2.....13.99	McDonalds Land *.....17.99	Shuttle.....19.99	
ATAC.....22.99	F16 Combat Pilot.....8.99	Mean Arenas.....17.99	Silent Service 2 (1 Meg).....22.99	
B17 Flying Fortress (1 Meg).....22.99	F17 Challenge.....10.99	Mega Collection.....16.99	Silkworm.....5.99	
Batman Returns.....16.99	F17 Challenge.....10.99	Mega Traveller 2 (1 Meg).....19.99	Sim City Deluxe.....22.99	
Battle Isle '93.....17.99	F19 Stealth Fighter.....11.99	Messengers of Doom.....19.99	Sim City+Populous.....19.99	
Battletoads.....19.99	FA Premier League.....17.99	Micro Machines *.....12.99	Sim Earth.....22.99	
Beastlord.....17.99	Falcon 3 *.....24.99	Mig 29 Fulcrum.....10.99	Sim Life (AGA).....22.99	
Beavers.....17.99	Fantastic Worlds.....22.99	Monopoly.....18.99	Simon the Sorcerer.....22.99	
Bitmap Bros Vol 2 *.....17.99	Fast Food Dizzy.....6.99	Morph.....17.99	Simon the Sorcerer (A1200).....29.99	
Blade of Destiny.....24.99	Fat Man.....17.99	Morph (A1200).....19.99	Sleepwalker.....21.99	
Blastar.....17.99	Ferrari Grand Prix *.....17.99	Mr Nutz.....17.99	Sleepwalker A1200.....21.99	
Blastar.....17.99	Final Fight.....8.99	Narco Police.....5.99	Slicks *.....12.99	
Blob.....17.99	Fire Force.....16.99	New Zealand Story.....6.99	Smash TV.....6.99	
Body Blows (1 Meg).....18.99	First Samurai + Mega-Lo-Mania.....19.99	Nick Faldo's Golf (1 Meg).....22.99	Soccer Stars Compilation.....16.99	
Brutal Sports Football.....25.99	Flashback.....20.99	Nicky 2.....17.99	Space Crusade & Voyage Beyond.....16.99	
Bubble Bobble.....6.99	Flight Sim II Western European Tour.....13.99	Nigel Mansell W.C. (A1200).....19.99	Space Hulk.....22.99	
Burnin Rubber.....16.99	Flight Simulator II.....24.99	Nippon Safes.....19.99	Star Trek (A1200).....22.99	
Caesar Deluxe.....19.99	Flight of the Intruder.....10.99	No Second Prize (1 Meg).....17.99	Starush *.....16.99	
California Games 2.....7.99	Football Crazy Compilation.....16.99	One Step Beyond.....13.99	Street Fighter 2 (1 Meg).....19.99	
Campaign.....22.99	Formula 1 Champions.....19.99	Overdrive.....16.99	Strider.....6.99	
Campaign 2 *.....11.99	Formula One Grand Prix.....22.99	Overkill (A1200).....17.99	Strip Poker 2 + Data Disk.....6.99	
Campaign Mission Disks *.....11.99	Galactic (A1200).....19.99	PGA Tour Golf Tournament Disk.....9.99	Super Barbarian *.....16.99	
Captive 2 *.....20.99	Global Gladiators.....20.99	PGA Tour Golf+.....19.99	Super Cauldron *.....16.99	
Cardiacc.....8.99	Goal.....20.99	Pang.....6.99	Super Fighters Compilation.....17.99	
Castles 2 (A1200).....24.99	Goblins 2.....19.99	Perfect General.....22.99	Super Hero *.....19.99	
Championship Manager 93 (1 Meg).....16.99	Graham Gooch World Class Cricket.....19.99	Perfect General Data Disk.....14.99	Super League Manager.....17.99	
Chaos Engine.....16.99	Graham Taylor (1 Meg).....16.99	Pinball Dreams.....16.99	Super Tetris (1 Meg).....16.99	
Chaos Engine (A1200).....17.99	Grand Prix Circuit.....8.99	Pinball Fantasies.....6.99	Superfrog.....17.99	
Chuck Rock 2.....16.99	Grusome *.....16.99	Pinball Magic.....6.99	Sword of Sodor.....8.99	
Civilisation (1 Meg).....22.99	Gunship 2000 (1 Meg).....22.99	Populous & Promised Lands.....10.99	Syndicate Data Disk.....13.99	
Civilisation (A1200).....26.99	Harpoon + Battleset 2.....22.99	Populous 2+ (1 Meg).....22.99	Team Yankee 2 (1 Meg).....19.99	
Claws.....17.99	Harpoon Battleset 3.....9.99	Powermonger.....9.99	Terminator 2 (See Dream Team).....19.99	
Cohort 2.....19.99	Harpoon Battleset 4.....9.99	Prehistoric 2 *.....16.99	The Greatest.....21.99	
Combat Air Patrol *.....19.99	Harpoon Scenario Editor.....13.99	Prehistoric 2 *.....16.99	The Immortal.....10.99	
Combat Classics.....19.99	Harrier Jump Jet *.....22.99	Human Race - The Jurassic Levels.....19.99	The Kristal.....6.99	
Contraptions *.....13.99	Heroquest 2.....18.99	IK+.....6.99	The Legend Of Robin Hood.....26.99	
Covergirl.....17.99	Hill Street Blues.....17.99		The Last Vikings.....20.99	
Crazy Cars 3.....16.99	Hired Guns.....19.99		The Patrician.....24.99	
Creepers.....19.99	History Line 1914-18 (1 Meg).....22.99			
Crusaders of the Dark Savant.....27.99	Human Race - The Jurassic Levels.....19.99			
Crystal Kingdom Dizzy.....14.99	IK+.....6.99			

SPECIAL OFFERS

Blues Brother.....8.99
Chuck Rock.....10.99
Kick Off 2 1 Meg.....9.99
Kick Off 2 Final Whistle.....7.99
Kick Off 2 Giants of Europe.....7.99
Kick Off 2 Return to Europe.....7.99
Kick Off 2 Winning Tactics.....5.99
Kick Off 2 i Meg.....7.99
Seymour Goes to Hollywood.....6.99
Thunderstrike.....5.99
Turbo Challenge 2.....8.99
Wing Commander (1 Meg).....14.99
Zool.....13.99

EDUCATIONAL

ADI English (All Ages).....17.99	ADI French (All Ages).....17.99	ADI Maths (All Ages).....17.99	Alvins Puzzles.....12.99	Better Spelling (8-14).....13.99	Cave Maze (8-12).....9.99	Fun School 2 (6-8).....6.99	Fun School 2 (+8).....6.99	Fun School 2 (U6).....6.99	Fun School 3 (5-7).....13.99	Fun School 3 (+7).....13.99	Fun School 3 (US).....13.99	Fun School 4 (5-7).....16.99	Fun School 4 (7-11).....16.99	Fun School 4 (US).....16.99	Fraction Goblins (8-13).....9.99	Junior Typist (5-10).....10.99	Magic Math (4-8).....13.99	Maths Dragons (6-13).....9.99	Maths Mania (8-12).....13.99	Noddys Big Adventure.....16.99	Noddys Playtime (3+).....16.99	Paint & Create (5+).....17.99	Paint Pot 2.....12.99	Picture Fractions (7-10).....9.99	Play Room (3-8).....17.99	Play School (3-8).....13.99	Prof Looks at Words.....16.99	Prof Makes Sentences.....16.99	Prof Plays a New Game.....16.99	Reasoning with Trills (5-12).....9.99	Shopping Basket.....12.99	Tidy the House (6-10).....9.99	Which? Where? What?.....12.99
----------------------------------	---------------------------------	--------------------------------	--------------------------	----------------------------------	---------------------------	-----------------------------	----------------------------	----------------------------	------------------------------	-----------------------------	-----------------------------	------------------------------	-------------------------------	-----------------------------	----------------------------------	--------------------------------	----------------------------	-------------------------------	------------------------------	--------------------------------	--------------------------------	-------------------------------	-----------------------	-----------------------------------	---------------------------	-----------------------------	-------------------------------	--------------------------------	---------------------------------	---------------------------------------	---------------------------	--------------------------------	-------------------------------

3.5" BLANK DISKS

	TDK/VERBATIM (BOXED)		PRECISION (BOXED)		UNBRANDED (LOOSE)	
	LOW	HIGH	LOW	HIGH	LOW	HIGH
10	7.99	9.99	6.49	7.99	5.99	6.99
20	14.50	19.50	11.99	13.50	10.99	13.50
50	35.00	47.50	26.00	37.50	23.99	32.50
100	65.00	95.00	49.99	72.99	44.99	62.99
200	125.00	190.00	94.99	141.99	83.99	121.99
500	300.00	470.00	219.00	350.00	199.99	287.50
1000	580.00	930.00	419.99	680.00	369.99	530.00
3.5" Recycled - Loose						
10	4.50	7.50	5.00	17.50	10.00	15.00

JOYSTICKS/ACCESSORIES

1/2 Meg Upgrade.....24.99	1/2 Meg Upgrade + Clock.....26.99	Quick Joy Top Star.....17.99	Quick Joy 2 Turbo.....10.99	Quick Joy Jet Fighter.....11.99	Cheetah 125+.....7.99	Competition Pro Extra.....14.99	Competition Pro 5000.....13.99	Technoplus Scorpion Plus.....9.99	Technoplus Scorpion Junior.....6.99
---------------------------	-----------------------------------	------------------------------	-----------------------------	---------------------------------	-----------------------	---------------------------------	--------------------------------	-----------------------------------	-------------------------------------

ANALOGIC
ANALOGIC
ANALOGIC

Analogic Computers (UK) Ltd
Unit 6, Ashway Centre,
Elm Crescent
Kingston-upon-Thames
Surrey KT2 6HH

Telephone Mon-Fri 9am-6.30pm
Sat 9am-5.00pm
081-546 9575
Tel/Fax: : 081-541 4671

COMPUTERS AND MONITORS REPAIRS WHILE-U-WAIT!!!

- * AMIGA A500/A600 and MONITOR REPAIRS WITHOUT DIAGNOSTIC FEES
- * FIXED CHARGES (A500 ONLY)
- * FAST TURNAROUND
- * MANY REPAIRS DONE WHILE-U-WAIT
- * WE PROVIDE PICK-UP SERVICE FOR REPAIRS FOR ONLY £5.00 + VAT
- * QUOTATION ON A600 AND MONITOR REPAIRS

£49.95 (A500 ONLY)
including NEXT DAY DELIVERY by COURIER SERVICE when dispatched back

MONITORS

CM 8833 MK II.....	219.95
SC 1435.....	199.95

PRINTERS

HP 510.....	299.95
HP 500 Colour.....	349.95
HP 550 Colour.....	549.95

FLOPPY DRIVES

1 MEG 3.5" A500 Internal.....	44.95
1 MEG 3.5" A600 Internal.....	44.95

ACCESSORIES

512K RAM A500.....	19.95	SUPER PRO ZIPSTICK.....	14.95
512K RAM A500 +.....	19.95	10 BRANDED BLANK DISKS.....	9.95
1MEG RAM A500 +.....	24.95	10 UNBRANDED BLANK DISKS.....	5.95
1MEG RAM + Cock A600.....	34.95	MODEM CABLE.....	9.95
AMIGA 400 DPI Mouse.....	14.95	PRINTER CABLE.....	9.95
SCART LEAD.....	9.95	A1200 RAM.....	POA
MOUSE MAT.....	4.95	ACCELERATORS.....	POA
DUST COVER.....	4.95		

CHIPS AND SPARES

KICKSTART ROM V1.3.....	19.95	8375 1 MEG FATTER AGNUS.....	24.95
KICKSTART ROM V2.04.....	24.95	8375 2 MEG FATTER AGNUS.....	29.95
KICKSTART ROM V2.05.....	24.95	PAULA.....	19.95
ROM SHARER + V 1.3 ROM.....	34.95	GARY.....	9.95
ROM SHARER + V2.04 ROM.....	39.95	CIA.....	8.95
ROM SHARER.....	19.95	68000.....	14.95
A500/A500 + Keyboard.....	44.95	6570 KEYBOARD CHIP.....	19.95
AMIGA PSU.....	44.95		

★ All prices include VAT and NEXT DAY DELIVERY subject to availability ★ Fixed charge for repair does not include disk drive replacement nor keyboard
★ All prices subject to change without notice ★ We reserve the right to refuse any Amiga repair



microCENTRE
computers

20a Westmorland Street Wakefield
West Yorkshire

**AMIGA
A1200**

NO HARD DRIVE	£279.99
64Mb HDD 2½"	£429.99
85Mb HDD 2½"	£479.99
170Mb HDD 3½"	£499.99
220Mb HDD 3½"	£519.99
340Mb HDD 3½"	£649.99
420Mb HDD 3½"	£889.99

2½" DRIVES
FITTING ADD £10

40Mb	£129.99
85Mb	£219.99
120Mb	£299.99

3½" DRIVES

85Mb	£189.99
120Mb	£209.99
170Mb	£229.99
220Mb	£259.99

**hp HEWLETT
PACKARD**

HP Deskjet Printers

HP Deskjet 510	£289
HP Deskjet 500C	£349

CITIZEN

Dot Matrix Printers

Swift 90	£149
Swift 240C	£269

CALL FOR
LATEST PRICES

LOW
SOFTWARE
PRICES

SALES 0924 201953
HOTLINES 0924 290781

FOOTBALL TACTICIAN 2

New 93/94 version sets even higher standards and breaks more records.

Firmly established as the definitive football strategy game, FOOTBALL TACTICIAN 2 is now available in three superb versions: FT2 ENGLAND the original and the first ever management game where tactics and real-time match intervention are the main requirements for a successful campaign. FT2 SCOTLAND the first ever simulation covering the soccer scene north of the border featuring the Premier and First divisions. FT2 ITALIA with the fabulous serie A and serie B for the thrills, the passion and the glory of the world's most exciting league! Three great games with the latest 93/94 stats. One soon realises that FT2 is no ordinary soccer manager. THIS is the REAL THING. You're in charge. Events on the field are the direct result of your inputs. Even when trailing badly, a match can still be retrieved if you make shrewd tactical interventions. There are risks involved, uncertainty and even luck. But in the end, it's all down to you! Can you rise to the challenge? Try FOOTBALL TACTICIAN 2 for the ultimate football experience!

What makes Football Tactician 2 so special?

- * Biggest ever multi-user system: up to 46 users! (who said four was the limit?) Now with new rating system reflecting managers' ability and achievements.
- * First ever fully interactive management game: intervene at any time during a match to change tactics, make substitutions, adjust formation or mark players.
- * Most accurate player definition: 30 parameters including real ages, aptitudes, skills, caps, playing positions, fitness, morale and market valuation.
- * Largest results database: 21290 match results and league positions going back 20 seasons all instantly retrievable. All of which may be printed out.
- * Professional recording: 36 matches always recorded IN FULL for full-scale replay.
- * First ever referee involvement: true to life behaviour. Beware of adopting 'rough tactics' when Jim Parker is in charge! The message is clear: know your refs.
- * Fastest ever setting-up time: initial start-up in less than two seconds, thanks to 900K of super-fast machine code. Smoothness of action is FT2's hallmark.
- * Most accurate editor: built-in intuitive editor capable of entering new players and fine-tuning all parameters. Essential for the serious user.
- * 16 different tactics from rough play to offside-trap adjustable throughout the match. You manage your side before AND during the match.
- * Three levels of match reporting, from highlights only to ball-by-ball commentary.

What are the new features?

- * FA Premier League and Division One permanently in memory with full interaction, promotions, transfers, European pool, play-offs, local and European Cups.
- * Man of the Match. Player of the Year. Manager of the Year. Transfer deadline. Pitch invasions. Fights between players.
- * Easy selection of penalty takers, free-kick takers, wingers, captains, ball winners, play-makers, overlapping full backs, reserves, substitutes...
- * Unique database-type search facility to locate any player in the league.
- * Full-scale printing facilities: highly suitable for Play-by-Mail.
- * Intelligent behaviour of computer sides capable of changing tactics to respond to situation on the field or making substitutions based on fitness and fatigue. Plus mid-week transfer and fitness news.
- * Friendlies, top scorers charts, precise transfer markets, club history, financial position and much much more!

Why is FT2 not in the shops?

The very essence of a football strategy game is its accuracy. With transfers happening every day, rules being changed and players being injured, shop games are out-of-date the moment they come out. Some publishers issue yearly revisions. That may be fine but not fine enough for us. The FT2 you buy is 100% up-to-date. We revise the program and data weekly. There are no compromises. Who wants to play a game that says that Fiorentina are in serie A, or Forest in the Premier League? Who wants to play a game that features Eric Cantona at Leeds or Ruud Gullit still at Milan? No known football game is more up-to-date than FT2 and that's a fact!

Please rush 1 copy of

- FOOTBALL TACTICIAN 2** £22.95
FT2 (Scotland) £22.95
FT2 Italia (serie A and serie B) £22.95

FT2 Double Pack (tick any two) £29.95

My machine is an
 AMIGA A500 (one meg) A600
 A1200 ATARI ST/STE

Name

Address

I enclose cheque for My Visa number is
 Visa or Access orders: same-day dispatch Overseas please add £1 p&p

TALKING BIRDS 0702 523607

5 Minster Close Rayleigh Essex SS6 8SF

The Punter[©]

- The UK's No.1 Football Pools program.
- Uses information from daily newspapers.
- For Littlewoods, Vernons and all coupons.
- Ideal for pools and fixed odds.
- The Punter can be used for British and the Australian pools. (Includes new 1993 pts)

The company which brought you the best horse racing software in the World, *The Tipster*, now brings you *The Punter*, our pools prediction program. Simple to use, and taking only 30 mins, this program allows you to predict all 58 matches on a coupon. Please phone for a demo disk (£9.95 refundable) which also contains *The Tipster (Horses)* and *The Dogs (Greyhounds)*.



£29.95

inc VAT



Sidmouth Software

PO BOX 7, SIDMOUTH, DEVON EX10 0TD

☎ 0395 67073 (24Hrs)

We pick out top-quality software and indispensable hardware for you and your Amiga, and we deliver them to you at bargain prices.

CREDIT CARD HOTLINE
0458 73279



Make sure you check out our amazing back issues and subscription offer on Page 168!

Adorage



On issue 48's Coverdisk we featured a working demo of Micro-PACE's excellent video effects titler, *Adorage*. Now we're offering AF readers a special deal for the full version, including full technical support and a manual to help you make the most of all the titling effects.

Description	RRP	Price	Order Code
Adorage	£79.99	£59.99	AMF300

VideoMaster



MicroDeal's new combined audio and video digitiser enables you to capture both sounds and pictures for manipulation on your A500 or A500 Plus, allowing you to make your own multimedia movies.

Description	RRP	Price	Order Code
VideoMaster	£69.95	£64.95	AMF245

Mail ORDER

Sportsmasters



Not only *PGA Tour*, the best golf game ever (and don't believe anyone who tries to tell you otherwise), but *Indianapolis 500*, *Advantage Tennis* and *European Championship Soccer 1992*, all in one box. Buy it!

Description	RRP	Price	Order Code
Sportsmasters	£29.99	£24.99	AF252

Fun School 4



Let the kids and the Amiga make friends, with Europress' acclaimed educational software!

Description	RRP	Price	Order Code
Teddy Disk	£24.99	£17.99	AM231
Frog Disk	£20.99	£17.99	AM232
Spy Disk	£24.99	£17.99	AM233

Home Accounts 2

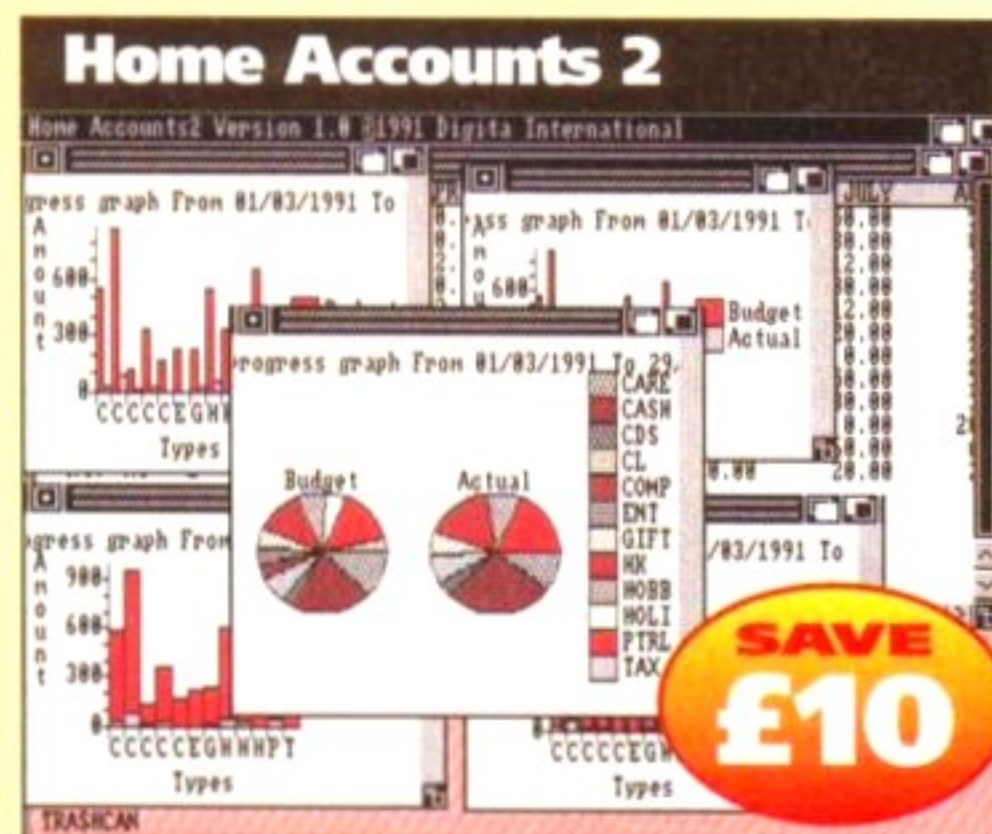

Described by *Amiga Format* as 'a package which will suit any household', this is the ideal way to keep track of your financial affairs, from what's in your cheque account to how much is left after the bills!

Description	RRP	Price	Order Code
Home Accounts 2	£54.99	£44.99	AF229

History Line



The course of the Great War is explored in this excellent war/strategy game from Blue Byte. Based on their earlier successful game *Battle Isle*, *History Line* scored an incredible 94 per cent in AF43.

Description	RRP	Price	Order Code
History Line	£34.99	£29.99	AF251

RAM Expansion



It's well over a year since new Amigas were sold with less than 1Mb of memory. Nowadays many games, as well as most serious software, require that magic meg. Here's a bargain way to upgrade your A500.

Description	RRP	Price	Order Code
512K RAM Expan	£29.99	£25.99	AM237

Amiga Format Binder

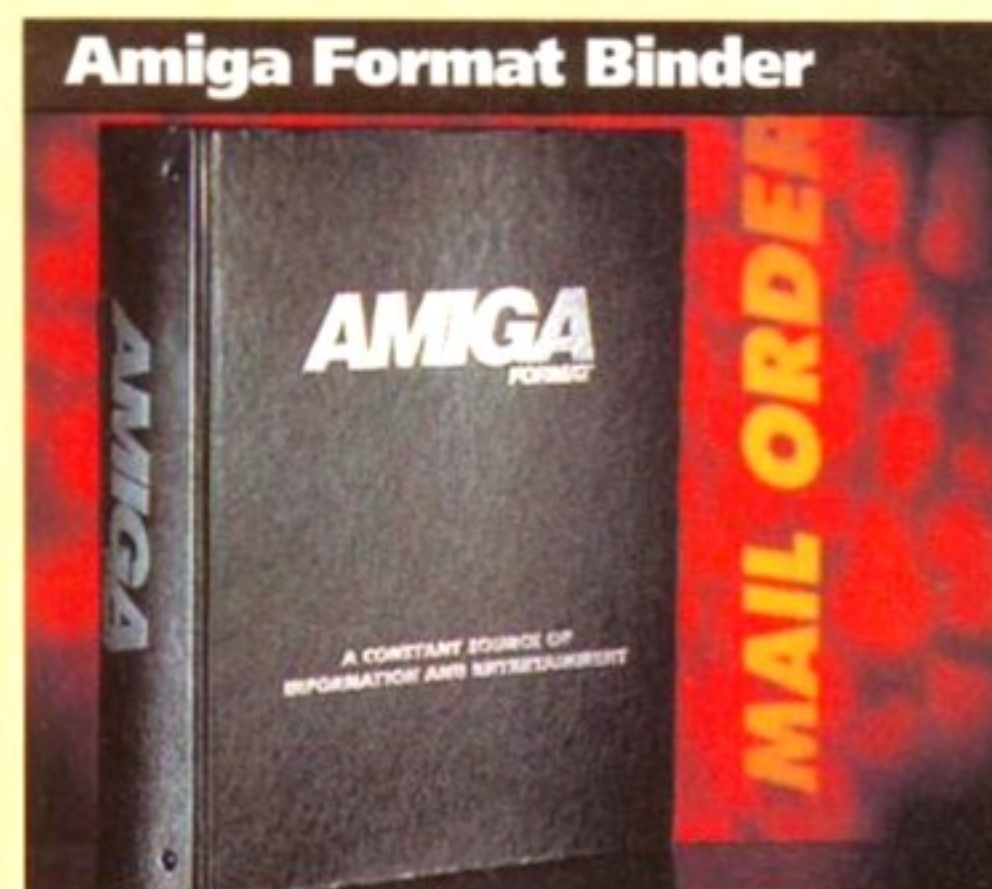

Are you tired of all your *Amiga Format*s being left scattered over the floor? If so, protect them with these stylish and practical black-and-silver binders.

Description	Price	Order Code
One binder	£4.95	AF108
Two binders	£9.00	AF109

THE SOCCER EXPERT

Football Result Forecasting



- ✗ **FOR FIXED ODDS & POOLS**
Instantly updates all major English & Scottish league data from result information.
- ✗ **THE INTELLIGENT WAY TO WIN**
Interactive prediction system & statistics - help narrow those odds.
- ✗ **HOME WIN? AWAY WIN? DRAW?**
Gives a 'Certainty' value based on stored information. All easily accessed with superb flexibility & control.
- ✗ **POINT AND CLICK USER INTERFACE**
Database of 1993/94 fixtures, including results - up to date of despatch. Editable league tables and bookmakers' 'handicap' starting points.

"An Effective Researched & Designed Football Prediction System."



£16.95 inc. p&p

32a HIGH STREET, WELSHPOOL, POWYS, SY21 7JP U.K.

Rush me copy/copies of 'The Soccer Expert' at £16.95 each TODAY!

NAME: ADDRESS:

POST CODE: Please make cheques/ postal orders payable to VOITHIA. Orders normally despatched within 24 hours.



NEW

AMIGA A600 & (HD) CONSOLE UNIT

- Monitor console and keyboard unit
- Second drive space
- No hard drive restrictions
- Power supply space
- Keeps cables tidy
- Non-magnetic aluminium
- High quality texture finish
- Plenty of ventilation
- Installed in minutes
- Designed specifically for the A600 and A600HD

Only £34.95 incl P&P

A REAL SPACE SAVER! - KEEPS EVERYTHING REALLY TIDY



AMIGA A500 AND PLUS CONSOLE UNIT

- Monitor console and keyboard unit
- Second drive space
- No hard drive restrictions
- Power supply or modulator space
- Keeps cables tidy
- Non-magnetic aluminium
- High quality texture finish
- Plenty of ventilation
- Installed in minutes
- Designed specifically for the A500 and 500+
- Colour coordinated.

Only £34.95 incl P&P

A real space saver! - Over 1,000 satisfied customers



NEW

A1200 CONSOLE UNIT

- Monitor console and keyboard unit
- Second drive space
- Power supply space
- Keeps cables tidy
- Non-magnetic aluminium
- High quality texture finish
- Plenty of ventilation
- Installed in minutes
- Designed specifically for the A1200.

Only £37.50 incl P&P

European Distributors Wanted

KONTAX COMPUTERS

11a Waldeck House, Waldeck Road, Maidenhead SL6 8BR



0628 773212



Phone lines manned between 8.00am - 9pm (No ansaphone!)

ONE PIECE DUST COVER ALSO AVAILABLE - PLEASE CALL

INTRODUCING TT2 ADVANCED SOUND SAMPLING SYSTEM

- DIRECT TO HARD DISK RECORDING
- BUILT IN TRACKER
- 18 FUNTIME EFFECTS
- PULL DOWN MENUS
- CONTROLLABLE EFFECTS
- SEQUENCER
- DIGITISER

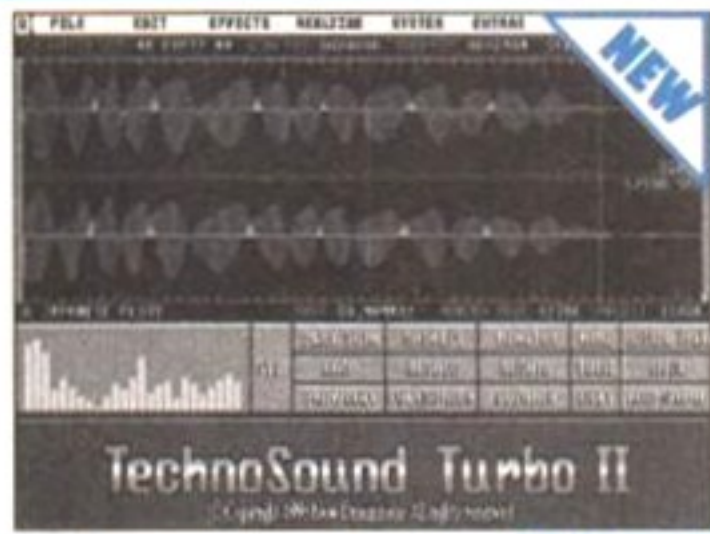

Special Intro Offer£42.99 Normal RRP £49.99 SAVE £7
Software only version£24.99 Normal RRP £29.99 SAVE £5

Upgrade Kit available to existing TechnoSound Turbo users write to New Dimensions for details. **ONLY £15**

BRITAIN'S NO 1 ENTRY LEVEL SOUND SAMPLING SYSTEM TECHNOSOUND TURBO

"Every Amiga owner should have it"
- Amiga Format
Ideal for beginners.



ONLY £27.99 Normal RRP £39.99

ORDER FORM

PLEASE SEND ME

Name

Address

I ENCLOSE CHEQUE/PO FOR

FIRECREST DISTRIBUTION
P.O. Box 39,
ABERGAVENTNY, GWENT NP7 6XL.
TEL (0873) 850028

ADD £2.00 PER ITEM P&P

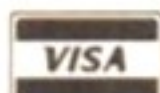

LOWEST PRICED TOP QUALITY RIBBONS, INKJETS, TONERS & DISKS

Printer Ribbons

BLACK	1 off	2+	5+	10+	BLACK	1 off	2+	5+	10+
Amstrad DMP 2000/3000	2.80	2.65	2.45	2.25	Panasonic KXP1123/1124/1140	3.46	3.31	3.11	2.91
Amstrad DMP 4000	3.66	3.51	3.31	3.11	Panasonic KXP1080/1180/90/1592	2.89	2.74	2.54	2.34
Amstrad PCW8256/8512/LQ3500	2.85	2.70	2.50	2.30	Panasonic KXP2123/2180	5.75	5.60	5.40	5.20
Brother M1009/1024/1109/1209	3.90	3.75	3.55	3.35	Seikosha SL90/92/95	5.70	5.55	5.35	5.15
Citizen 120D/LSP10/Swift 24/9	2.85	2.70	2.50	2.30	Star LC10/20/100	2.29	2.14	1.94	1.84
Commodore MPS1220/1230	4.50	4.35	4.15	3.95	Star LC200	3.00	2.85	2.65	2.45
Epson LQ100	4.10	3.95	3.75	3.55	Star LC24-10/200	2.86	2.71	2.51	2.31
Epson LQ400/500/800/850	3.45	3.30	3.10	2.90	Taxan Kaga KP810/815/910/915	3.14	2.99	2.79	2.59
Epson FX/MX/RX80/FX/LX800	2.90	2.75	2.55	2.35					
Epson FX/MX/RX100/FX/MX1000	3.36	3.21	3.01	2.81					
Epson LX80/86/90	2.12	1.97	1.77	1.67					
Mannesmann Tally 80/81	3.90	3.75	3.55	3.35					
NEC Pinwriter P2200	3.03	2.88	2.68	2.48					
OKI ML182/183/192/193/195	3.17	3.02	2.82	2.62					

Ring for Ribbons Not Listed

Ring us and WE WILL BEAT all other Ribbon prices

3 1/2" Disks & Disk Boxes

	DS/DD	DS/HD
10 Disks	\$5	\$8
25 Disks	\$12	\$18
50 Disks	\$22	\$32
100 Disks	\$40	\$60
250 Disks	\$88	\$145
500 Disks	\$168	\$285

Preformatted (MS-DOS) disks available at 2p extra/disk.

All Disks Certified 100% Error Free and INCLUDE FREE Labels.

Miscellaneous Items

Roll 1000 3 1/2" Disk Labels	8.99
3 1/2" Disk Cleaning Kit	2.99
Parallel Printer Cable (1.8m)	3.99
Mouse Mat	2.99

Inkjets, Ink Refills & Toners

Canon BJ-10/20 Cartridge	17.54 each
Commodore MPS1270 Cartridge	10.05 each
HP Deskjet Cartridge (Double Cap.)	24.24 each
HP Deskjet Tri-Colour Cartridge	28.89 each
HP Thinkjet/Quickjet Cartridge	10.05 each
HP Deskjet Tri-Colour Cartridge Refill	16.00 each
Inkjet Refills (Twin Packs) for Canon BJ-10/20, BJ300, HP Deskjet. Available in Black, Cyan, Magenta, Yellow, Red, Blue, Brown, Light Green, Dark Green and Gold.	
1 Pack \$11.00, 2+ Packs \$10.60 ea, 5+ Packs \$9.95 ea	
HP Laserjet II/III Toner Cartridge	44.51 each
HP Laserjet III/III Toner Cartridge	53.14 each

Ring For Inkjets & Toners Not Listed

CPU & Monitor Dust Cover	5.49
Monitor Dust Cover	4.99
80 Column Printer Dust Cover	3.99
Amiga 500 Dust Cover	3.99
Amiga 600 Dust Cover	3.99
Amiga 1200 Dust Cover	3.99

All Prices INCLUDE VAT (@ 17 1/2%) & UK Delivery

0543 250377 0543 250377

Ring us or send cheques to:

Owl Associates Ltd, Dept 126, Owl House, 5 The Brambles, Lichfield, Staffs WS14 9SE

Official Government & Educational orders welcome

E.O.F.

NATIONAL CURRICULUM

Reach the top with.....

LCL Self-Tuition Courses

Make a start now (age 3yrs - GCSE - A Level).

Totally comprehensive courses (each has 24 programs with a book and manual, or equivalent)

...of excellent quality (eg. "Definitely a first-class package" AMIGA SHOPPER).

.....with far too many topics to list, but some examples are:

MICRO SPANISH (Beginners - GCSE & Business)

Real speech (on disk) • Graphics adventure game • Talking Cartoon • Vocab. by Pictures • Business letter generator (1Mb)

NEW

MICRO FRENCH (Beginners - GCSE)

Real speech • Graphics adventure game • Talking cartoon

ST.F "Best Buy"

MICRO GERMAN (Beginners - GCSE & Business)

Real speech • Graphics adventure game • Business letter generator

MICRO MATHS (11 years - GCSE)

GCSE CHART-TOPPER

Algebra • Geometry • Trigonometry • Statistics • Arithmetic

MICRO SCIENCE Physics, Chemistry, Biology (8 years - GCSE)

Tuition • Practical experiments • Learning by pictures • Adventure game (1Mb)

"GHI S/W Choice"

MICRO ENGLISH (8 years - GCSE)

Spelling • Punctuation • Grammar • Literature

PRIMARY MATHS COURSE (3-12 years)

Tables • Add • Subtract • Divide (Long & Short) • Multiply • Fractions

in ATARI Fam. C.

READING WRITING COURSE (3-12 years)

Handwriting • Creative writing • Reading • Spelling

MEGA MATHS (A level course)

Calculus • Algebra • Geometry • Full-screen graphs

£5 OFF TOTAL FOR 2 COURSES, £10 OFF FOR 3, £17 OFF FOR 4

(*All appropriate LCL Courses are National Curriculum compatible & run on most computers.)

Send cheques/P.O.s (£24.99 per course all inclusive) or phone orders, or requests for free colour poster/catalogues to:

LCL (DEPT AMF), THAMES HOUSE, 73 BLANDY ROAD, HENLEY-ON-THAMES, OXON RG9 1QB

Phone 0491 579345 for immediate dispatch

ATTENTION! COMMODORE & AMIGA END USERS & DEALERS

TOP SELLER ADVANCED AMIGA ANALYSER AN INEXPENSIVE DIAGNOSTIC ANALYSER THAT WORKS ON ALL AMIGAS

Amiga Shopper says "Without doubt, this is the finest diagnostic equipment I have ever seen, and I address all Amiga repairers and practical-minded users when I say this is really something worth having."

A complete diagnostic hardware and software analyser (uses point and click software interface). The analyser plugs into all Amiga ports simultaneously and through sophisticated software displays 6 screens to work from. Shows status of data transmission/signals: tests game port function, parallel port, serial port, disk drive, video ports, memory (buffer) checker, system configuration and auto test. Reads diagnostic status of any read/write errors from track 0 to track 79. Software automatically tells what errors are found and chips responsible. 85% to 90% of the problems presented to service centres are found with this analyser. Saves you lots of money on repairs and no end user or repair shop can afford to be without one. Don't be fooled by its low cost. Simply plug in cables from the analyser box. This sophisticated tool is used by end users and Amiga repair centres worldwide.....£47.00

WE CARRY ALL COMMODORE CUSTOM CHIPS AND ACCESSORIES AT LOW AMERICAN PRICES.

WRITE FOR FULL LISTING OF ALL

COMMODORE/AMIGA SURPLUS PRODUCTS.

DEALERS: WRITE TO US ON YOUR LETTERHEAD

THE GRAPEVINE GROUP INC. 3 CHESTNUT STREET, SUFFERN, NY 10901 U.S.A.

INTERNATIONAL ORDER LINE: (914) 357-2424

FAX LINE: (914) 357-6243

POOLSWINNER

1993/4 THE POOLS PREDICTION PROGRAM WITH ARTIFICIAL INTELLIGENCE

Gold

- THE LEGENDARY POOLS PREDICTION AID, Poolswinner, now has artificial intelligence. The latest version of the program, Poolswinner Gold, has the power to learn from the results of its own predictions, constantly adjusting the prediction formula to improve performance.
- AUTOMATIC FIXTURE GENERATION: Fixtures for English and Scottish League matches are generated automatically by Poolswinner Gold (yearly updates are available from Selec).
- MASSIVE DATABASE: 22000 match database over 10 years.
- PREDICTS SCOREDRAWS, NO-SCORES, AWAYS and HOMES Predictions are based on many factors - recent form, the massive database, league standing, goal scoring rates, and draw averages. The user can adjust all parameters.
- SUCCESSFUL Selec guarantee that Poolswinner performs significantly better than chance.
- LEAGUE AND NON-LEAGUE matches are covered. Can be used for the non-league and amateur matches often on the coupon.
- FULL LEAGUE TABLES (home & away) are automatically generated by the program as results come in.
- UPDATED WEEKLY. Poolswinner Gold is supplied fully updated with all league results from the start of the season
- IMMEDIATE USE No need for tiresome input of previous results. All results are already in the program - predictions can start immediately.
- PACKAGE CONTAINS disc, detailed operating manual and support literature.



£42.50

Also available from Selec ...

COURSEWINNER V4 £36.50

THE PUNTER'S COMPUTER PROGRAM. With artificial intelligence. Uses past form, going, distance, speed ratings, prize money etc. Contains British course statistics - best jockeys, trainers, draw effect etc. Detailed analysis of all runners in a race, with sophisticated aid to successful betting, with a long pedigree.



POOLS PERM PLUS £32.50

Perm analyser and checker, complete with 5 years of coupon results and popular perms for analysis. Checks your weekly entry for winning lines, or tests your theories on results over the last 5 years. Reveals all the weeks a bet would have won, and the probable dividend.

Formats available:

IBM (3 or 5), AMIGA, ATARI ST / Falcon

All programs are supplied on disc, packaged with detailed instruction manual, and support literature.

Prices are inclusive of VAT & delivery

Send cheque / PO for return of post service to ...

Selec Software (Est. 1984)

62 Altrincham Rd, Gatley, Cheshire SK8 4DP

Tel 061-428-7425

(send for full list of our software)

*Phone or FAX 24 hrs

WorkBENCH

Whatever your problem (as long as it is Amiga-related) we are here to solve it. Scribble down your woes and send them off to us at: Workbench, Amiga Format, 30 Monmouth Street, Bath, Avon BA1 2BW.

THIS AMIGA IS DEAD

From P Leonard, Great Yarmouth
Help, I think I have killed my Amiga. I have an A600HD and I was mucking about with the hard drive trying to save software to it. Having given it up as a bad job I reset the machine only to get the message "Not a DOS disk in Device HD0:". Is this incurable or should I register it with a hospice? Please help. I don't even have the manuals any more and don't know where to get a replacement.

Well, whatever you tried to do to your hard disk, it didn't like it very much. What has happened is that the sectors on the disk which contain vital booting

and DOS information have been corrupted. This probably happened if you turned the machine off while the drive was being accessed – very naughty!

There are two things you can do. If you had vital information on the disk you can try resurrecting it with a recovery program such as *FixDisk* (which is PD and available from all good libraries). If you don't care much for what was on the disk, you can simply reformat it.

To do this you need to boot up from a Workbench floppy disk. When Workbench has loaded, click once on the hard disk's icon (which will be displayed as HD0:??? or HD0:NDOS) and

Continued overleaf

BLANKED BY ICONEDITOR

From Graham Birks, Chesterfield, Derbyshire

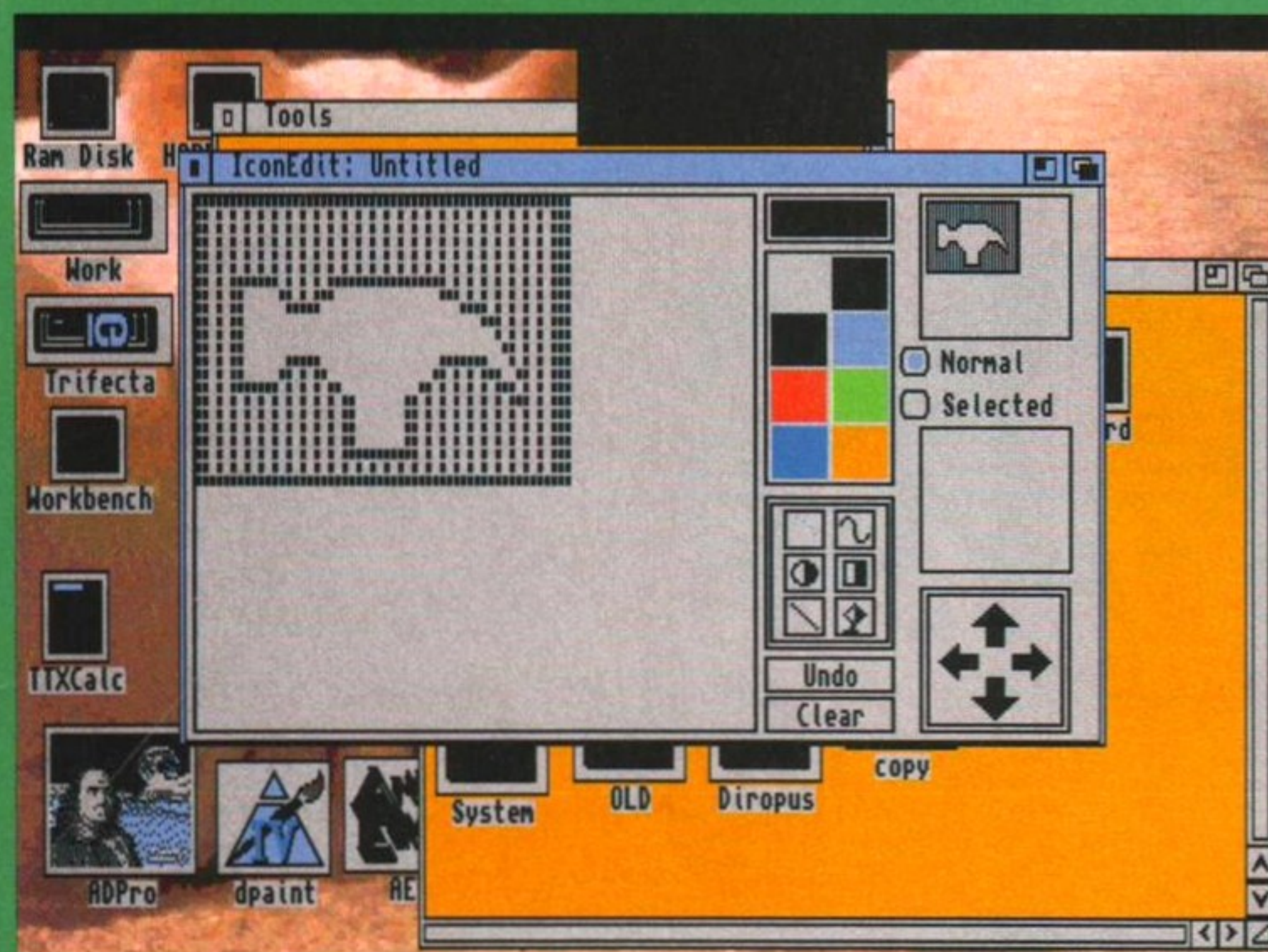

IconEditor on WB3 has hidden depths. If vast blank spaces are giving you grief, why not check the menu?

I have an A1200 with an 80Mb hard drive and I have a few questions. On *IconEditor* which comes with WB3, when I design icons for the RAM disk and my hard drive and then save them they leave a big blank space where I haven't actually drawn anything. I've gone right through the manuals but have found no solution to this.

Also, I already have *DPaint IV* and I want an AGA paint program. Would it be worth getting *DPaint IV AGA* or should I wait for *DPaint V*?

Well, the *IconEditor* problem is quite simple. When you have finished drawing your design and are ready to save it, simply select the Auto TopLeft option from the Extras

menu. This will reposition your icon into the top left-hand corner of the editing window and eliminate any spare background colour which is left underneath and to the right of the image you have drawn. Now save the icon without making any other changes and your problems will be solved.

As to the *DPaint* question, it is very likely that EA are thinking about a *DPaint V* and that, since *IV* AGA has been included in the new A1200 box, its release will be sooner rather than later. Upgrade deals are always available, though, so if you can't wait, go for the AGA version now and upgrade later. It may be that you don't need the latest version – don't buy until you have seen the authoritative review in *Amiga Format*!

IF YOU HAVE A QUERY...



Nick Veitch, your host...

At *Amiga Format* we aim to answer as many questions as we possibly can every month, and hopefully to sort out all your problems. Of course there are always more questions than answers, so we have to prioritise queries according to the following factors:

- **Frequency.** If a lot of people seem to be having problems with their Supersonic KY3000 printers then we will print one letter and the definitive answer, encompassing all the most frequently posed problems.
- **Difficulty.** If the problem is actually something which only someone with some insider technical knowledge would be able to solve, it is more likely to be answered in these pages than a problem which arises simply because you haven't read the necessary documentation.
- **Impact.** Quite simply, a question which involves you not being able to use your machine or some peripheral or software at all will be given a higher priority over a difficulty which is little more than a slight inconvenience.

Unlike some magazines we won't just concentrate on the areas of expertise we are most familiar with, we will take on any problem (as long as there is an Amiga involved in it). We have even enlisted the help of Commodore's Chief Engineer for those particularly tricky questions. As you can understand, we do get a lot of questions. If you want to get yours noticed, here are a few tips:

DO

- Be concise.
- Detail as best you can the actual problem.
- Where applicable, describe the sequence of events that caused the problem.
- Give details of the equipment you are using (including which version of Workbench you are using and which model of Amiga you have).
- Make sure your question is relevant, and wouldn't be more easily solved by the dealer you bought the goods from.

DON'T

- Tell us all about your aunty Ethel for three pages and then explain your problem.
- Write in with questions like "I added a hard-drive to my machine and it doesn't work – what should I do". (Which machine? Which drive?)
- Send an SAE expecting a personal reply. The chances are extremely slim.

Please bear these points in mind and remember that we are trying our best to help you.

WORKBENCH - HINTS, TIPS AND HELP NOVEMBER 1993

select Format Disk from the icon menu. Once the disk has formatted you will then have to copy all the Workbench stuff back on.

As for manuals, they tend to only come with machines, but you could phone Commodore on 0628 770088 and ask nicely.

CD CONSOLES? OR IF NOT, WHAT?

From Jeffrey Levine, Cheadle Hulme

I have a few short questions to ask you.

- 1) Should I get an A1200 or a CD³²?
- 2) Why do games tips appear in the mag so soon

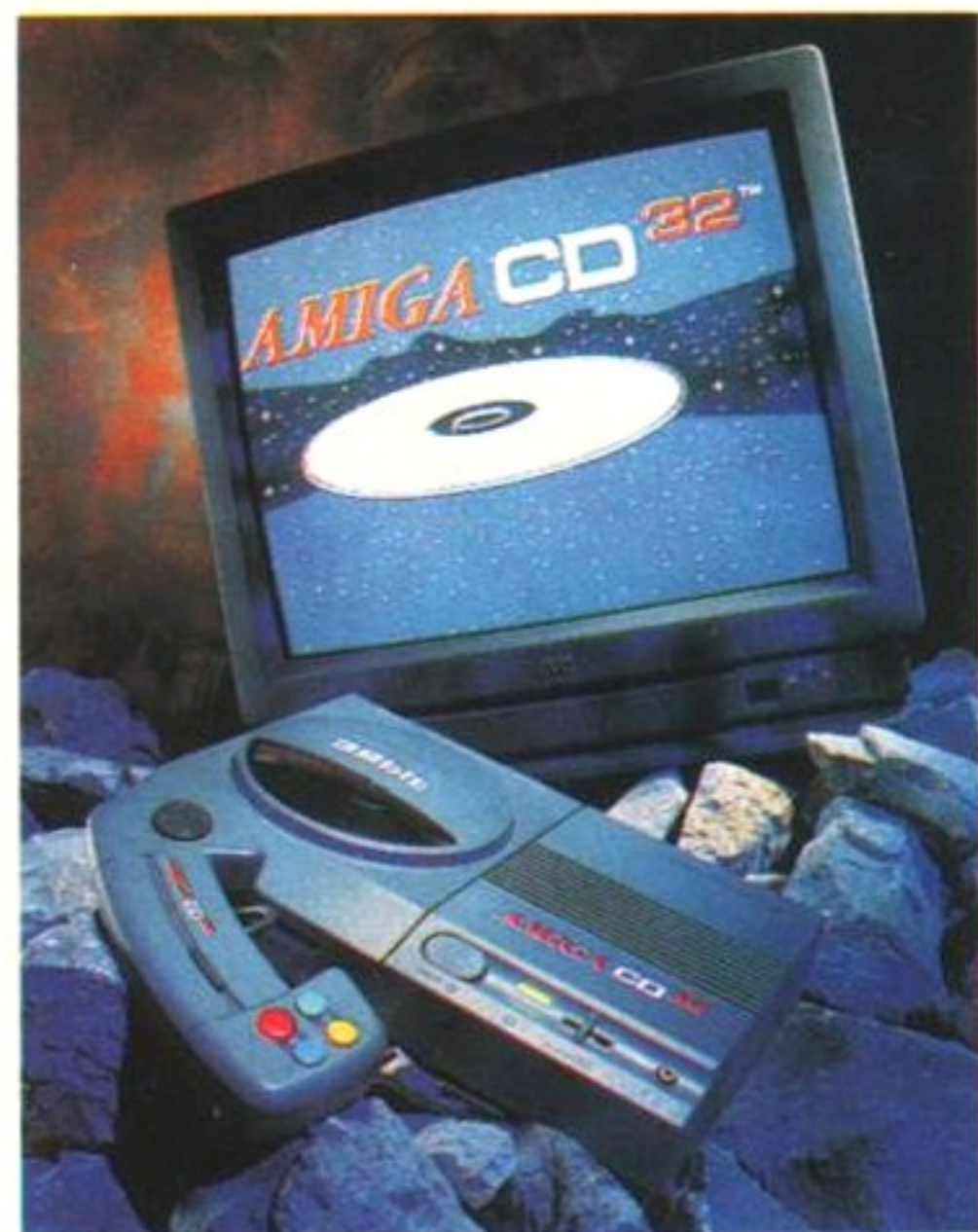

The Amiga CD³² is obviously superior to the Mega Drive, but what of the other CD-based systems?

after the game is released? I find this annoying because I only have the game a few days and then it is finished.

- 3) Will the Action Replay III work with the CD³²?
- 4) Why is the Amiga CD³² always compared to the Sega Mega Drive when everyone knows the Amiga is much better?

Well, here are a few brief answers then.

- 1) Buy both. They're both brilliant.
- 2) They generally appear at least two months after a game is reviewed and often longer. If you think this is too quick you could always bury your issue in the back garden and dig it up six months later.
- 3) No.
- 4) Because it is the only other CD-capable console unless you count the 3D0 (which isn't released) or the CD-i (which is more than twice the price).

SEEING THE LIGHT

From David McAllister, Belfast, Norn Iron

Having just bought an A600 I have just one question. In the user manual it states clearly that you must not remove a disk from the computer's drive while the drive light is on.

When playing games such as *Flashback*, it asks you to change disks, but the drive light remains permanently on. What is going wrong?

There is nothing wrong with your machine. Unfortunately many games programmers don't expect Amiga owners to follow the advice in their manuals. What is usually happening in these cases is that the drive is spinning but the heads aren't actually accessing the disk itself.

So long as you *only* ever do this with games and you make sure you can't hear the disk spinning, it is not dangerous to remove the disk at these times,

but it does cause a small amount of unnecessary extra wear and tear on your disk drive. If everybody wrote stern letters to the games software houses involved in doing things this way, perhaps this bad habit would die out...

A1200 WORRIES

From Peter Worrall, Cleethorpes

After recently upgrading from an A600 to a nice new A1200 I was somewhat surprised to discover that Workbench 2.05 worked on the new machine. I was given to understand that in order to run a Workbench disk, you needed to have the corresponding ROM - please explain.

Also, when I select the Original Chip Set from the boot menu, will this option stay operative until I reboot the computer?

Lastly, when I turn the computer on it takes over ten seconds before the Insert Workbench screen appears. This process only took about six seconds on my A600. Is there something wrong with my new machine?

Well, any previous version of Workbench should run on the A1200. If they didn't, self-booting PD disk and magazine Coverdisks would have a hard time. It doesn't work the other way round, though - a 1.3 machine won't run WB2 or WB3.

When using the boot options they are only effective until the next reset - if you turn the machine off or reset it using the keyboard any options will return to the default settings.

The A1200 does take longer to 'warm up', because the ROM has more system checks to make (more custom chips, more memory... it all adds up to more work for the ROM). Ten seconds does seem a little long, but if it comes up in under 15 I shouldn't worry.

AMOS ANSWERS

THIS MONTH IN the new-look Workbench section we see the start of a new column dedicated to the thousands of people enjoying the fruits of the amazing complete AMOS Coverdisk program we gave you as a rather nice little present to celebrate the festive season last Christmas.

There are always a few problems when trying to get to grips with a new programming language - especially if you are completely new to programming. Hopefully the Mastering AMOS series we have been running will have got you off to a flying start, but if you have more specific problems this is the place to come.

Every month the most interesting or tricky problems will be answered here, so if your utility isn't working quite the way you intended it to, your code gets all twisted up in knots or your programming skills desert you when it comes to parallax scrolling, get writing now!

Q The first problem comes from Paul Smith of Merseyside. He asks: "Is there any way of having two AND commands in an IF command? I am trying in vain to put exceptions to months in a diary program - 29 days in February in a leap year, thirty days in April and so on. At present my line reads as follows:

```
If Year$="96" and MONTH$="2" and MOTH-
    DAYS="29" THEN LOOP
```

"This references back to a DO command earlier in the program. Every time I try this or something similar I get an error informing me that I am mismatched. What can I do?"

A Well, the problem is that AMOS likes to have just as many LOOP commands as it has DO commands. If you have several of these exceptions

then you will have more LOOPS than DOs which will confuse AMOS. Although some languages will allow you to have conditional loop commands, this is very bad programming practice and I fully support AMOS in not allowing this.

What you will have to do is set up a flag system and use the REPEAT command, like this:

```
REPEAT
    -
    - ;your loop code
    -
    If Year$="96" and MONTH$="2"
    and MOTH$="29" THEN Flag=1
    If MONTH$="4" and MOTH$="30"
    THEN Flag=1
    - ; and any more exceptions
UNTIL FLAG=1
```

That should solve your problems. Using a flag system to exit your loop is not only AMOS-approved, but also makes your code a lot easier to follow.

Q Our next problem is from Zoë Curbishlex of Lower Peover, Cheshire. She tells us: "I have written a number of small programs in Easy AMOS but my programs always seem to get very large. Also I don't understand how I can use graphics, such as those created in DPaint, in my AMOS programs. Do you know where I can get old AMOS code which I could use for reference?"

A Well, without seeing any examples of your code I'm not terribly sure exactly where you are going wrong with your code. It seems likely

MAXIPLAN PLEA

From Mark Anderson, Leven, Fife

I own an A500 Plus with 2Mb RAM and an external drive. I recently purchased *Maxiplan 4*, but have had a lot of trouble getting it to work.

Every time I try to double-click on the icon an error message appears telling me that I need "explode.library v4+".

The libs directory on the disk contains a file called *explode.library* but when I attempt to move it I get the message "Error 213 - disk not validated". Please, please, say that you can help.

I can help. Is that good enough?

No, I suppose you want me to tell you what's going on. Well, the program is looking for the *explode.library* in the libs directory of your start-up disk. There are two things you can do.

You could boot directly from the *Maxiplan* disk, which should solve all your problems. Alternatively, you could copy the library to the libs directory of your usual boot-up disk, which is what I presume you were trying to do when you got the error message.

If the disk is not validated, AmigaDOS will not allow you to write to the disk at all. This is because without validation the system doesn't know which parts of the disk are in use and doesn't want to delete them accidentally.

The best course of action would be to make a copy of this disk immediately, then try and copy the library you need.

HOW MANY MEGS?

From Matthew Ayles, Colchester, Essex

I want to buy a hard drive for my A1200, and I have a large collection of games and utilities which

Continued overleaf

NO MORE FLICKING VIDEO MODES

From Nigel Stutt, Whitley Bay, Tyne and Wear

I have read your answers to similar queries regarding video resolution images, monitors and flicker fixers but I am still confused. I would like to set up an Amiga system capable of generating images in *Real3D*, *Imagine*, *DPaint* and *Morph Plus*.

I know that it is necessary to get a flicker fixer for the A500 to use high resolutions, and I assume the 4000 has one built in, but what about the A1200? What sort of A1200 setup would I need to produce images of a quality similar to that of those produced by Foundation Imaging for *Babylon 5*, as shown in your excellent article?

You do need a flicker fixer for interlaced screen modes, but not for the hi-res and super hi-res modes.

You will need a dual-scan, tri-scan or multiscan monitor to use the Productivity and DBLPAL screen modes that are available on the A1200, though.

Using DBLPAL and a 1960 or similar monitor you can simulate the resolution of an interlaced screen in high resolution, giving an effective resolution of 676 by 547 pixels using overscan.

Alternatively you can get a flicker fixer and use an interlaced super hi-res screen which is 1440 x 566 pixels (or you can do this without the fixer and let it seriously do your head in).

If you want a 1200 to produce serious graphics you will need a hard drive (around 150Mb minimum) and lots



Resolutions of up to 676 by 547 are available without resorting to an interlaced display mode and a severe headache.

of RAM, preferably with an accelerator thrown in. An extra 8Mb of RAM is my minimum recommendation for ray-tracing and image processing.

There are a number of good accelerator-plus-RAM cards available for the A1200 such as the Microbotics series, the GVP A1230 and the Power PC1204, depending on just how much acceleration you want.

For output to video you don't need a flicker fixer. Interlaced images will record fine. A flicker fixer is only worth the money and effort if you are going to display the finished images on screen rather than on video, in a presentation situation perhaps.

that you are not using enough subroutines. If you plan your code well enough you will find that there are particular parts of the program (usually display routines) which are often repeated. It is very useful to make these into subroutines, both in terms of saving space and in making your code easier to follow.

IFF graphics cannot be loaded directly into AMOS. You need to use the grabber from the Bob Editor program supplied. This is not terribly complicated and it is explained in great detail on Pages 129-166 of your *Easy AMOS* manual.

There are many AMOS clubs and societies. One which may be of interest to you is the Nothing But AMOS Club, who produce a regular disk-based magazine costing just £2.50 a month. You can contact them at N. B. AMOS c/o Neil Wright, 39 Riding Dene, Mickley Square, Stockfield, Northumberland NE43 7DL.

Q Andy Hayes from Almley in the West Midlands is having a bit of trouble with his mega-epic platform game. The trouble is that he can't get his Bobs to detect when they have run into a wall or landed on something unpleasant.

This, as we all know, can be more than a little disadvantageous when you are trying to write a game, and dealing with AMOS Bobs could almost take up a complete issue of the world's best Amiga magazine on its own. But many people seem to be having similarish difficulties, so here we go.

A Well, the answer is collision detection. AMOS has a command especially for this eventuality, and it works along the lines of...

`x = Bob Col (y)`

...where y is the number of the Bob you are interested in. X will then return a value of -1 if a collision is detected. If you check all your Bobs you will be able to tell which two have bumped into each other.

Obviously if your Bobs are mapped in a grid, there may only be a part of the Bob that you are interested in. The collision detection works by using the hot spot points.

These are automatically set to the top left of the Bob, but in fact can be set to anywhere using the hot spot command. The syntax for this is...

`Hot Spot n,x,y`

...where n is the number of the Bob and x and y are the co-ordinates of the point. These values are calculated from the top left-hand point. Note that the hot spot can lie outside the actual visible area of the Bob's graphics data.

There are a number of preset points which can be used if you can't be bothered working them out for yourself. These are entered in the format...

`Hot Spot n, $xx`

...where n is the number of the Bob and xx is one of the following values:

- 00 - top left
- 01 - middle left
- 02 - bottom left
- 10 - middle top

- 11 - middle centre
- 12 - bottom centre
- 20 - top right
- 21 - middle right
- 22 - bottom right

The actual points are calculated automatically by AMOS from the dimension data of the Bob.

That should give you a start. Good luck with the game and always remember to keep track of your Bob priorities!

Q The last question is from Nicky Leatherland in Derby. He is trying to load a *Soundtracker* module into AMOS so that he can fiddle about and do devilish things with it.

A Well, the answer is to use the Track Load command with the name of the file you want to load. I think from your query, though, that the difficulty is that the track you are trying to load is not actually a *Soundtracker* track, but one which has been compressed with a utility called *PowerPacker*.

To load in this file you would have to uncompress it either by using *PowerPacker* or the Public Domain utility *Decrunch*. Alternatively you could load it into a track player which supports crunched modules and then save it out again in an uncrunched format.

Right, well that is about all we have space for this time around. If you have any queries please send them in to me at AMOS Answers, Amiga Format, 30 Monmouth Street, Bath BA1 2BW. Until next month, happy coding!

I would like to put on it. What size of drive would you recommend? I am currently looking at 120-170Mb drives. Should I be considering a PCMCIA hard drive?

Also, when it is finally released I will be wanting to add a CD drive. Will having an internally installed drive prevent me from adding this too?

The thing about hard drives is that they are never big enough. If you are like me and hate throwing things away, you will soon discover that you need about 600Mb at least.

Realistically, you can fit a minimal system and a select crop of utilities into a 60Mb drive, but then you have nowhere to store your data. The answer is really that you should buy the biggest one you can afford. I would think that sensibly (depending on how big your games are) 150Mb would be sufficient.

An internal drive is probably the best solution, as it will use the Amiga's power supply and be tucked neatly out of the way. A PCMCIA is a useful second drive (or even as a first drive if you can get it cheaper than an IDE).

Remember that unless you choose to have it fitted for you by a recognised and ICL approved dealer, installing an internal drive will invalidate your warranty, whereas a PCMCIA drive won't.

When the CD drive is finally release, it is likely that it will use the trapdoor expansion underneath your A1200, so it will not affect either of your possible hard drive options.

TRACKBALL TROUBLE

From Nicholas Batchelor, London

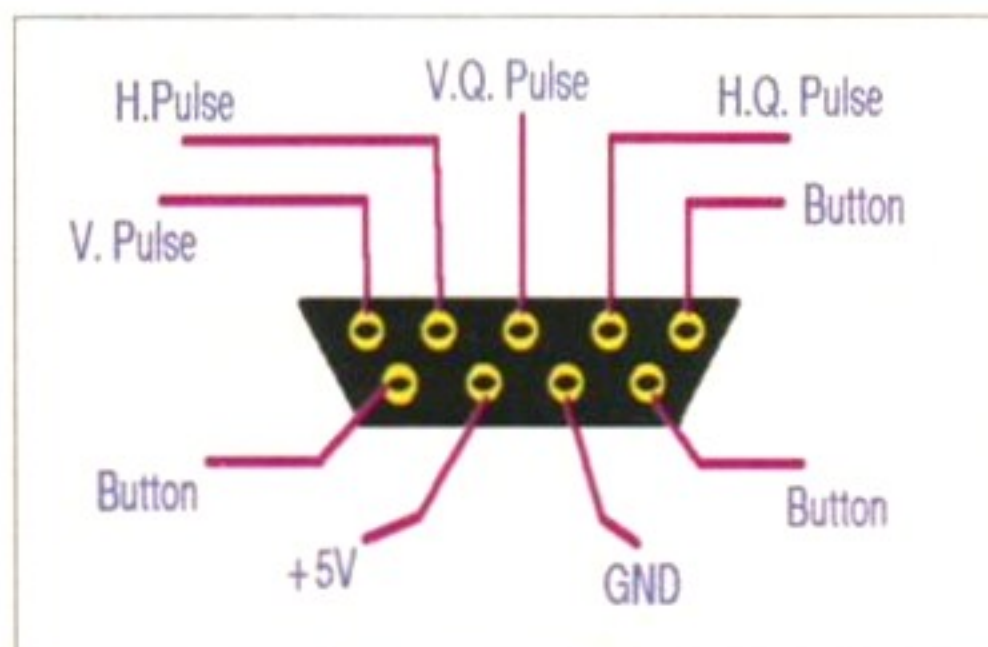

If you want to know how your mouse is wired up, these are the connections. Make any sense? (Not really -Ed.)

Having used my Contriver trackball for a couple of years the mouse pointer now refuses to move up or down. I know that the trackball is at fault because the mouse still works fine. I tried opening up the trackball unit to see if I could find anything that had obviously gone wrong.

I found an orange wire loose inside but having checked the terminals inside I can find no signs of this wire ever having actually been connected. What could be wrong?

The mouse port is configured for mice or trackballs as shown in the diagram here. If you are only having problems with the vertical motion it is likely to be either the vertical pulse or the vertical quadrature pulse. If you are getting absolutely no movement at all, it is more likely to be the vertical pulse line that isn't working.

If the terminals are marked at all it will be labelled as VP or simply V. If not, then your best bet is trying to track the line back to the photodetector which controls the vertical wheel.

Unfortunately this model has been superseded so we have no terminal information on it, but you

Continued overleaf

To the point...

Q I own a still video camera which captures and stores single video frames. What I really need now is a piece of hardware that will put the picture into my Amiga, enable me to play around with the picture and print it out.

A Well, the first piece of equipment you will need is a video digitiser. This will accept a video signal and convert it into an Amiga-displayable image.

As you have a still camera, you do not necessarily need a frame grabber, but it may be worth considering Rombo's Vidi range. Vidi12 should do the job you require, but it depends on exactly what you want to do with the resulting pictures. For more info, give Rombo a call on 0506 414631.

If you want to play around with your pictures, you should think about *DPaint IV* (not the AGA version) or perhaps *GVP's ImageFX* or *ASDG's Art Department Professional*. Any and all of these programs are quite capable of printing out your finished work, but they will print much better if you use *TurboPrint*, which was on last month's Coverdisk.

Q Please could you tell me if there is a cheap tape streamer device available for the A500 Plus and what speed it can do? Also is there any way that I can get all my programs put onto a CD for use with the CDTV/A570 machines, like the Kodak PhotoCD machine can do for photos.

A You can use any SCSI tape streamer with your Amiga, providing you have the correct interface. The A590 and HD8+ hard drives for the A500 both have SCSI through ports. If you are looking for a cheap backup system though, you would be much better off with the Video Backup System which uses a clever technique to record all your data onto a videotape using your normal, common-or-garden video recorder.

As for mastering a CD, this can be an expensive business. A one-off disk might cost you as much as £1,000. To buy a CD read/write drive, such as those used for Photo CD, you would expect to pay somewhere in the region of £4,000. It doesn't say in your letter whether you are immensely rich or not, but assuming you are not, mastering your own CD is a bit out of the question.

You neglect to say why you want to set up such a system, but if you are serious I suggest you contact Almathera Systems on 081 6836418.

Q What is the difference between a compiler and an interpreter?

A Well, they both perform the same function (converting a written language into code which a computer can execute), but in different ways. An interpreter deals with each line of code as it comes to it. This means that it runs a lot slower than an executable file, as the conversion is done while the program is running.

With a compiler all the instructions are translated in advance to create an executable file. This can take quite a while, but it means the resulting code is an executable file which runs a lot faster.

Compilers can increase the development time of a piece of software because the program has to be compiled every time it is tested, but the increase in speed is worth it for most applications.

Q How can I add a password program to protect data on my Amiga?

A The first thing you need to do is get hold of the password program, or write one yourself. If you do write your own it will have to stand alone (in other words, be an executable file in its own right rather than one that needs to run via an interpreter) so that it can be

called from the CLI. Then simply run it from your startup-sequence. Unless you have installed some other custom software, it should be safe enough to call your program at the start of the startup-sequence.

To do this simply add your program to the C: directory of your boot-up disk and edit the startup-sequence file (in the S: directory) so that the first line is the name of your program. The rest of the sequence won't be carried out until your program quits.

Unfortunately, this method is not really secure (people could still boot up your Amiga from other disks and get into your data from there), but it would stop errant cousins and small children from re-formatting all your disks when you weren't around.

Q I am upgrading from an A500 to an A4000/030. Is it possible to somehow use my old A500 hard drive?

A It depends. You can't just plug in an A500 expansion into the Zorro slots on an A4000. You may be able to use the mechanism, though. If your drive has an IDE mechanism then you can attach this to the IDE controller which comes with the A4000.

This is a quite straightforward operation, but you will have to take apart your old drive and disconnect the mechanism. There will be two cables connected to the mechanism. One will most likely be an IDC multiway connector which directly corresponds to the one inside the A4000. The other will be the power supply - four wires ending in a socket.

The 4000 also has these cables, but they may be a different size. It may be worth checking the board of your hard drive for indications of which wire is which in this case and then "adapting" one of the A4000's cables.

If you have a SCSI hard drive, you will need a SCSI controller card for your A4000. Attaching a SCSI mechanism is much the same process as the one outlined above and instructions will no doubt be supplied with the SCSI controller when you buy it.

Q Please could you tell me if there is an x-y plotter available for the Amiga and will my programs support it?

A There is no direct support for any type of x-y plotter through Workbench, so you are really restricted to the ones that are supported by your software. To the best of our knowledge the only programs which do directly support plotters are *X-Cad*, *Provector* and *Professional Draw*, which can all drive an HPGL-compatible plotter.

This is a fairly common standard for modern plotters, but you may find that since demand for plotters is not what it was, that such devices are both hard to find in a local computer store and expensive. Depending on what exactly you need from your plotter it may be a lot easier to build one.

Q Where can I get hold of details of Commodore's include files?

A The include files themselves are usually bundled with development systems such as the assembler *Devpac* or the C language *SAS C*, under licence from Commodore. If you need to get your hands on listings of them you will need to buy the book of the official *Rom Kernel Reference manuals*, published by Addison Wesley (0734 794000).

The volume you want is cryptically called "Includes and Autodocs". The same publishers also produce a wide range of other specialist Amiga volumes which could be of great use to you if you wish to get into some serious programming. Why not ask them to send you a catalogue?

If you want to find out what's new, have a great day out and pick up some bargains for Christmas, then come along to the

Christmas INTERNATIONAL COMPUTER SHOW



For the Home and Small Business user

Opening times:
Friday
10.00 - 6.00
Saturday
10.00 - 6.00
Sunday
10.00 - 4.00

Ticket prices:
On the door £7,
under 10s £5
In advance £6,
under 10s £4

19, 20 & 21 November 1993
Wembley Conference and Exhibition Centre, Hall 1

Interactive demonstrations
Presentations of new products

*Key feature areas including:

The Popular Electronic Music Centre with Keyboards of 93 and Home Recording, featuring equipment from Atari and Commodore.

Home and small business centre, featuring equipment from major brands including IBM, Amstrad and Digital.

Virtual Reality Centre.

Simulator and Games Centre.

Advice centres and computer clubs.

Over 150 companies selling the latest available products and services and offering excellent show prices.

Westminster
EXHIBITIONS

Westminster Exhibitions Ltd,
The Cotton House
PO Box 36
Dinas Powys
South Glamorgan
CF64 4YN

Ticket hotline:
0726 68020

**Pre-Purchase your tickets by
12th November to save time and money**

To: International Computer
Show, PO Box 68,
St. Austell PL25 4YB

Please send me _____ Fast Lane Tickets @ £6.
_____ Under 10's Fast Lane Tickets @ £4

I enclose a cheque / P.O. / Credit card details for £ _____ made payable to
International Computer Show

Name _____

Address _____

Postcode _____ Fax No. _____

Credit Card No. _____ Expiry date _____

OR phone 0726 68020 to book with credit card



LEW'S CORNER



Each month Lew Eggebrecht, that nice man in charge of Commodore's Engineering division, will be answering your questions here in Workbench.

From Simon Liddiard, Odiham, Hants
I have an A500 Plus (which features 2Mb Chip RAM, 2Mb Fast RAM, 512K 32-bit RAM) with a CSA Mega Midget Racer and a Commodore A590 fitted with a 42Mb SCSI drive. All this is housed in a Checkmate A1500 casing.

Unfortunately rendering animations eats into my hard disk space and I am looking to upgrade it by about 100Mb or so. I was wondering if it would be possible to drive more than one SCSI drive directly off the A590's controller by using an appropriate cable.

I know it would be possible to add an external drive, but this would be a rather expensive option and not a particularly elegant one. This is particularly so as my machine has to be fairly portable.

LEW SAYS:

The SCSI interface supports six drives plus the controller. You can therefore have up to 6 SCSI drives connected to an A590. Since the A590 is an older product, however, you may need to upgrade your current A590 firmware to revision 6.6 or better.

can always try just connecting the wire by hand and trying it out as you are very unlikely to damage either the trackball or the Amiga.

SIZE MATTERS

From Kevin Smith, Troon, Ayrshire

I have an A600 with Workbench 2.05 but I am having difficulty with space. Is there any way of splitting my Workbench over more than one disk because I don't have room for everything that I need, like all my printer drivers and fonts?

The trouble with Workbench, as with a lot of things this month, is that it isn't big enough. Thankfully there is an answer, and it comes in the form of the rather less than impressive-sounding Assign command.

When you boot up your machine, it automatically expects to find commands in the 'c' directory of that disk, libraries in the 'libs' directory, fonts in the cunningly named 'fonts' directory and so on.

These are the default settings, but they can be changed. If you wanted to have all your fonts on a disk called 'bigfonts' for example, all you would have to do is add this line to the end of your startup-sequence (or type it directly in to the CLI):

```
assign fonts: bigfonts:
```

You will then have to put this disk into the drive every time Workbench needs a font, though, which can be a pain if you only have one drive. There is no reason, on the other hand, why you couldn't put several different types of file on a separate disk (you can assign as many things as you like to one device).

A solution which most people prefer is just to delete all the things on the Workbench disk that they don't use and create space that way.

PAGESSETTER WITHOUT LACE

From Michael Simmonds, Leyland, Lancashire

I own an A500 with a GVP hard drive on which I have successfully installed Pagesetter. The program works fine, but the screen comes up in interlaced screen mode, which is a bit annoying.

After using the program for a while it will go back to a normal non-interlaced mode of its own accord, but surely there must be some way to get it to start up in this way?



Icons are not just for decoration, they can pass information to the main program.

Pagesetter will automatically fall back into non-interlace mode when supplies of RAM are running low (as an interlaced screen takes up twice as much memory as a standard one). There is a way to automatically set interlace off, though, and it is

done, as are many of the preferences, through the tool-types attached to the program's icon. This is the way most of Gold Disk's programs work.

To change the preferences, simply select the icon and choose "Information" from the Workbench's Icon menu. A screen will appear showing some information about the program and a list of the current tool types.

There will be one which reads "INTERLACE=ON", and you will simply have to change this to "INTERLACE=OFF". All the tool types and their meanings are explained in the manual.

UPGRADE QUERIES

From Richard Gleaves, Newcastle-Under-Lyme

My present set-up consists of an A500 complete with a Power Computing 1.5 Mb upgrade (the one that allows 1Mb of Chip RAM), a PC 880B second disk drive and a Star LC200 printer. Do you think that the new breed of incompatible AGA machines will mean that I will be able to get hold of a lot of peripherals for my machine at a significantly reduced price?

Also, is Directory Opus 4 capable of completely replacing the CLI and Shell?

I am thinking about upgrading, but will I be able to install a ROM switcher bearing in mind the expansions already in my machine? What about an internal hard disk as well?

Some interesting points. Firstly, I should think that you would be able to fit a ROM switcher internally, but I don't think you will want to. Because of the changes in the 2.04 ROM, the modifications you have made to your machine to accommodate the RAM expansion will be incompatible with a ROM upgrade.

Yes, I imagine that various peripherals, particularly those which use the expansion port, will be available at reduced prices. Bear in mind that a lot of these units have been selling on tight profit margins for some time, so the reductions may not be that impressive.

Directory Opus is a wonderful utility, but I'm not sure exactly what you mean by replacing the Workbench and Shell. Certainly it has been

HOW TO MAKE RAD AUTOMATIC

From Imran Majid, Leyton, London

Having recently got hold of an A1500 and a copy of *Get the Most Out of Your Amiga* I have been trying in vain to set myself up with a recoverable

RAM drive. I am quite sure that I have typed in the mentalist entry correctly and there seems to be no problem when I give the mount command, but I get no icon on screen. How can I copy my files into it to set up a recoverable Workbench?

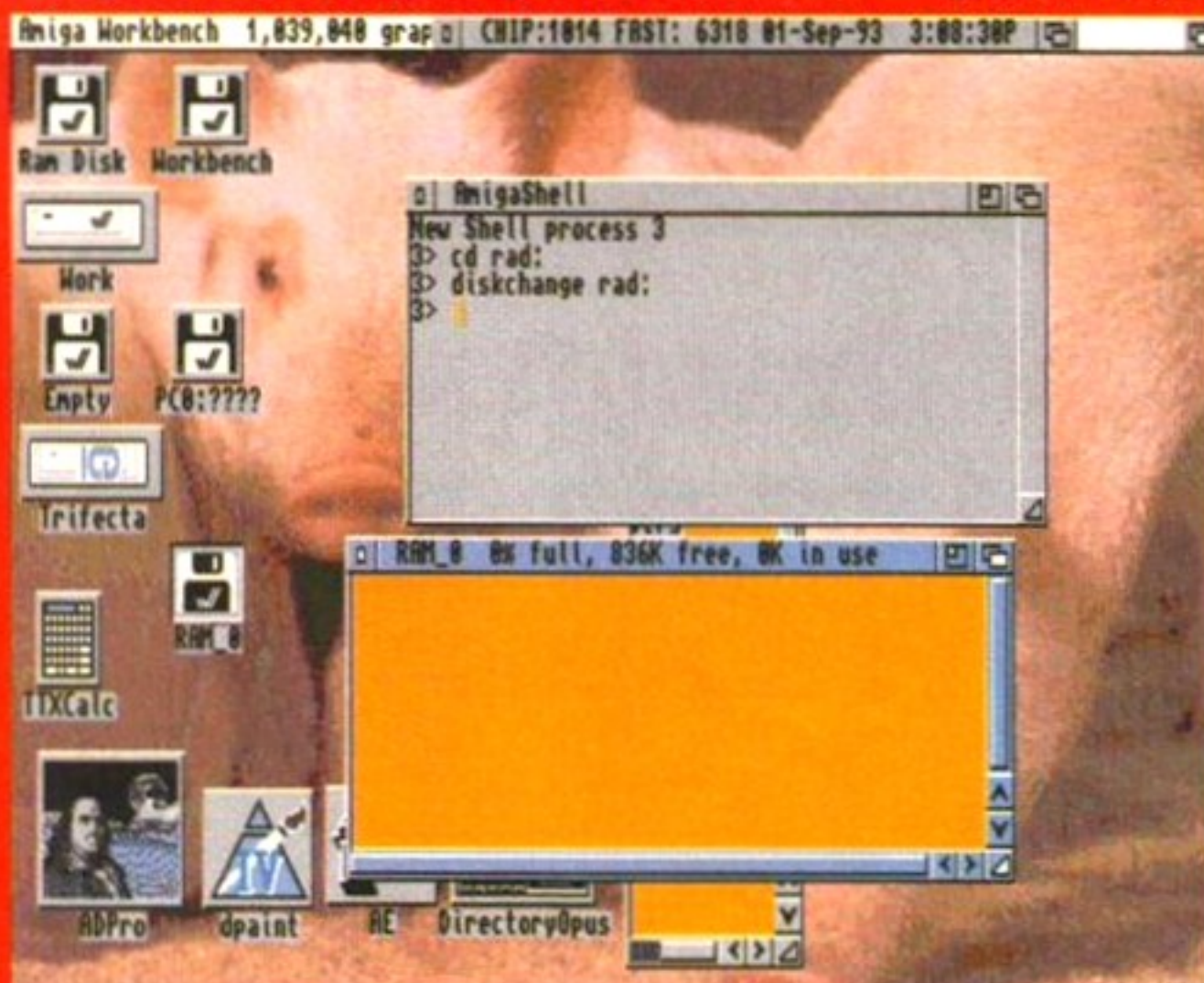

To use the RAD device you must simply ask Workbench politely if it minds. Failing that, using the Diskchange command will bring results.

Ah, if only the question were all so simple. What appears to have happened is that you have in fact completely correctly set up your RAD disk and it is working fine. The thing about Workbench, though, is that it can be a little dozy at times, and if you go around adding new devices after startup it isn't going to notice they are there until you tell it that they are.

The best way to do this is to issue the Diskchange CLI command, which was included with Workbench to solve a similar problem which occurs with 5.25 disk drives. Just open the shell and type:

```
diskchange rad:
```

and all your problems should very rapidly be solved.

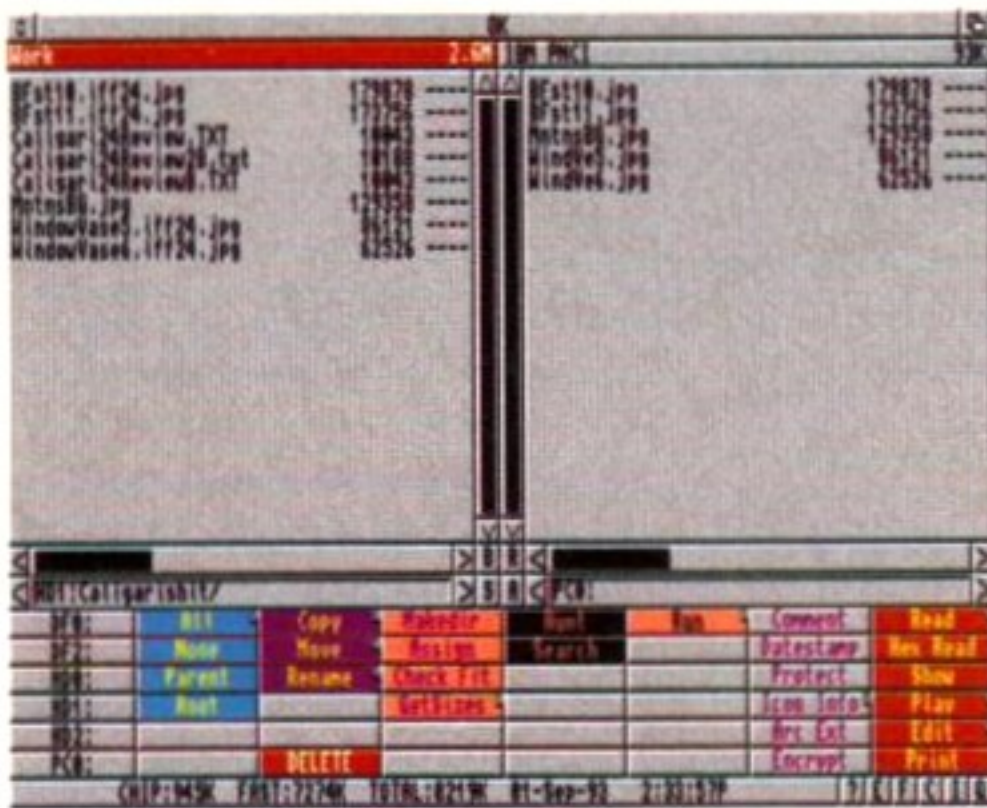

Directory Opus – can you live without it? Maybe not, but can it really replace the Shell?

installed on my machine for some time and does get a lot of use, but I still occasionally resort to the Shell or Workbench for particular operations.

It, or a utility like it (the Public Domain *SID2* for example) is certainly high on my list of utilities I would want with me should I be stranded on a desert island with nothing but an Amiga and a very long extension cable.

LARGE PRINT

From M. Coveney, *Leatherhead, Surrey*

I am just writing to find out if there is an Amiga wordprocessor with a large print option as standard or as an add-on. I am very short sighted and this would be a great help to me.

Well, you can actually use any one of the 'page publishing' packages which allow you to use fonts other than the default Topaz one. Packages which fall into this category are *Final Copy*, *Wordworth* and *Excellence*, as well as many others. Simply by choosing a larger Amiga font for your text will cause it to be displayed bigger on screen.

If you have a Workbench 2 or better machine you might also be interested to know that you can change the system's default font using the Font program in the preferences drawer. It may clutter up your Workbench a bit, but at least you will know what programs you are running. Changing the default text can cause problems with menu options in some applications.

SAMPLE SOURCES

From Adnan Rochdale, *Manchester*

I am very keen on music and I am considering getting hold of a sound sampler such as Technosound Turbo. What sort of devices can it be connected to in order to sample sounds? Is a sampler different from a MIDI interface?

Most samplers allow you to sample from a one-volt peak-to-peak audio source, such as those found on the 'Line Out' sockets of amplifiers, tape decks and CD players. You will not be able to connect it directly to a normal microphone – the signal will have to be amplified first.

MIDI stands for Musical Instrument Digital Interface, and a MIDI interface for the Amiga will allow you to control external MIDI keyboards and other MIDI devices. It does not actually send or receive any sound data, just control information, and is used for operating a number of musical devices when recording (or playing live) because it does away with all the nasty musicians (who would probably play the wrong notes anyway).

A MIDI interface is entirely different from a sound sampler, although Microdeal do produce a combined unit.

Indepth Explanation MEMORY



This Ashcom RAM expansion for the A1200 shows an 8 x 1Mb configuration of ZIP chips, which were the cheapest available at the time the board was designed.

- There are two different ways in which your memory is used on the Amiga. Chip memory is interfaced to the DMA (Direct Memory Access) bus, enabling it to be accessed directly by the CPU or any of the custom chips. Because of this direct access, it is often slower than Fast RAM. Fast RAM can be accessed only by the CPU.
- The amount of Chip memory you can add to your Amiga is determined by your Agnus chip. Older A500s can only access 512K of Chip RAM. Later versions of Agnus allowed 1 or 2Mb of Chip RAM to be added. All new Amigas are capable of having 2Mb of Chip RAM, fitted as standard.
- Older sound samplers and most art packages are limited by the amount of continuous Chip RAM they can access. This is because they use the graphics (Agnus or Alice) or the sound (Paula) chips' abilities to address the Chip RAM directly to perform some tasks.
- Some utilities, either provided with Workbench or available from PD libraries, help make the most effective use of your memory. The most useful of these is *FastMemFirst*, which forces programs to use Fast memory in preference to Chip memory.
- All memory which is added externally to the Amiga is Fast memory. There are many different types of Fast RAM expansion.
- The trapdoor slots on the A500, A500 Plus, A600 and A1200 are one area used by most third party manufacturers as a path to add expansion memory. Depending on which Amiga you have, vast amounts of memory can be added this way. Even the humble A500 can have 4Mb added in this way, although this does require some hardware modification.
- RAM is usually added to the A1500 and A2000 by a Zorro card. Because of their versatile design, almost any memory package is catered for.
- The main types of memory packages available are DIPs (Dual In-line Package), ZIPs (Zig-zag In-line Packages) and SIMMs (Single In-line Memory Module). All have their advantages and disadvantages, but mostly the preference is dictated by which is currently the cheapest, due to fluctuating world demand.
- Expansion port add-ons for the A500 and A500 Plus, such as hard drives, often feature the ability to add extra Fast RAM. The Commodore A590 does so by way of DIPs, while the GVP HDB+ uses SIMMs.
- Memory for the A4000 or the A1200 should be 32-bit wide memory, which is more expensive but much faster than the 16-bit memory used by older Amigas.
- Memory can also have different speeds. This can make quite a difference to memory intensive processing tasks. Access times for an average memory device would be around 100ns (nanoseconds). The fastest RAM available is likely to be custom-made video RAM, with an access speed approaching 20ns.
- It is also possible to get Static RAM expansions for the Amiga. Static RAM, unlike Dynamic RAM, retains whatever was in memory even after the power has been switched off. At the moment the most widely available Static RAM expansion is in the form of a PCMCIA card for the A600 and the A1200. Static RAM (or S-RAM) does have its drawbacks, the most important of these being the price.
- Accelerator cards usually come with their own memory. This is usually because most accelerator boards are capable of addressing a 32-bit bus and the addition of some 32-bit RAM makes them operate even faster.
- Poor old A3000 owners only have the on-board upgrade option of adding ZIP chips.

Rates and sizes One issue

1/8th of a page/68mm x 99mm £340
 1/16th of a page/68mm x 48mm £175
 *Company entry/30mm x 48mm £45
 *Company entries must be pre-paid.

Copy Deadlines

Issue
 December Thursday 30 Sept
 January Thursday 28 Oct
 February Thursday 25 Nov
 March Wednesday 22 Dec
 April Thursday 20 Jan

Please Note

Once a booking has been made, whether in writing or verbally on the telephone, it is the advertiser's responsibility to ensure that copy reaches us before the relevant deadline. An advertisement which cannot be run because of late supply of copy will be charged for a full rate.

Cancellations will be accepted only if they are given in writing and at least two weeks before the copy deadline. If a series booking is cancelled, an advertiser will be surcharged to the appropriate rate for the advertisements which have run.

A full list of our terms and conditions is available on request.

Free typesetting service

AMIGA FORMAT

Market Place

AF's classified section for your local Amiga dealer...

Programming Books **3**
 Free Catalogue from Bruce Smith Books
 A-Z Reference
 by Mark Smiddy 416 pages £21.95
 Order from (and cheques payable to):
**Bruce Smith Books Ltd, Freepost 282,
 PO Box 382, St Albans, AL2 3BR. Tel
 (0923) 894355 for credit card orders.**

Pools Professional 2
New Version 2.2
 Stores up to 16 League divisions
 Predict 1-1s, score draws, homes & aways
 Works with Eng/Scot & Aus Leagues
 Full printer support
 Free program updates, printed manual
 Only £12.95.
 Send three 1st class stamps for demo disk
**D. Ramsey, 2 The Paddocks,
 Haddenham, BUCKS HP17 8AG**

LOOK!
INK JET OWNERS
 CUT YOUR PRINTING COSTS UP TO
 SUPERB QUALITY INKJET/B.J. REFILLS (15ml)
4 Refills£11.99
8 Refills£16.99
16 Refills£29.99
 All inclusive
TEL: (0446) 748152
 INKY FINGERS 86 St. Mary's Avenue
 Barry CF6 6LS

GRAPHIC FAX
 Amiga Shareware & PD Software
 Fred Fish - Scope - Grapevine - AM/FM
 - Demos - Games etc.
 PD swapping service available.
 Fast & Friendly Service.
 Send £2.50 for our comprehensive
 2 disk catalogue + free game disk to..
PO BOX 69
MANCHESTER M21 2BN (FREE P+P)

Convert your Amstrad
COLOUR MONITOR
£9.95
 464/6128/664 £9.95
 with Stereo Speakers £29.95
 464 Plus (includes sound) £19.95
**Hagars Electronics, 3 Victory Street
 Sheerness, Kent ME12 1NZ
 TEL (0795) 663336**

COMPUDIAL
 For the latest Amiga hardware and software.
 Falkirk's first and only Computer Mail Order retailer.
 We sell the latest Amiga hardware, games software &
 serious software. In fact, almost everything
 associated with the Amiga.
 Please send £1 to the address below for our latest
 catalogue on disk.
**78 Langton Road, Falkirk, Stirlingshire FK2 9TA
 Tel: 0324 31513**

ARNOLD COMPUTER SUPPLIES
Amiga A1200 £290
Blank Disks £19 per 50 inc. labels
CD-32 £290
 Free local delivery (10 mile radius)
 All your computer needs catered for.
 Please phone or fax for latest prices.
 Manga videos now in stock.
 Please ring for information pack. Prices from £10.99.
Barry Voce 0602 264973
**11 Campion Street, Arnold,
 Nottingham NG5 8GR**

AR COMPUTERS
 Stockists of Amiga FC's and Printers
 100 x 3.5 DSDD Bulk Disks£35.00 inc. VAT
 100 x 3.5 DSHD Bulk Disks£55.00 inc. VAT
**149 Newport Road, Stafford,
 Staffs ST16 2E2**
Tel: 0785 222551

1-1 AMIGA CLUB
Sharing Success
 We sell PD at cheap prices!
 We sell Software at cheap prices!
 We sell Hardware at COST prices!
 Find out how by sending a blank disk & SAE to:
11 Avon Close, Addlestone, Surrey KT15 1JD
FREE MEMBERSHIP

£1 GVB-PD £1
AMIGA PUBLIC DOMAIN (DEPT AF)
**43 BADGER CLOSE, MAIDENHEAD,
 BERKSHIRE SL6 2TE, ENGLAND**
 PHONE: (0831) 649386 ALMOST ANY TIME
 FOR CATALOGUE DISK SEND 3 1st CLASS STAMPS.
 MAKE CHEQUES OR P/O OUT TO G.V. BROAD.
 GAMES - ANIMATIONS - DEMOS - SLIDESHOWS
 UTILITIES - MUSIC - GAMES CHEAT DOCS DISKS
1 STOCK ASSASSINS GAMES 1 TO 121
ALL DISKS £1 INCLUSIVE.

CPPD
 NOW IN 2nd YEAR
 PUBLIC DOMAIN FOR A500-A1200
 WORKBENCH 2 SPECIALISTS. ALL THE LATEST TITLES.
 PHONE CHRIS ON 0283 516736, PERSONAL HELPLINE
 (7 Days a week 9am-9pm)
 OR WRITE FOR A CATALOGUE DISK LISTING ONLY THE
 BEST PD AVAILABLE
 (Enclose 2 1st Class Stamps)
 MANY SPECIAL A1200 DISKS AVAILABLE
**3 DUNEDIN CRESCENT, WINSHILL,
 BURTON UPON TRENT, STAFFS DE15 6EJ**

Colour Laser Copies
From Amiga Disks
 400 DPI PRINTS VIA CANON LASER
 COPIER FROM IFF OR TIFF FILES.
 A4 FIRST COPY £11.75 PLUS P&P £1.50
 ADDITIONAL COPIES £1.75
 MADDOX REPROGRAPHICS LTD.
 15 MADDOX ST. LONDON W1R 9LE 071-629-5070

NJH PD
0702 546796
 Thousands of the latest and greatest PD titles
 available from as little as 80p.
 We also stock Fred Fish, Scope and Assassin disks.
 Send 50p or two first class stamps to the address
 below or call any time for more details.
**NJH PD, 12 MEESONS MEAD,
 ROCHFORD, ESSEX SS4 1RN**

URGENTLY WANTED
 Programs, Demos, Utils, Amos,
 Clip-art, Anims & Games.
 New PD Library going public soon.
 We will try to make your programs
 famous.
 All enquiries answered.
**12 SAXON TERRACE, WIDNES
 CHESHIRE WAB 6JY
 TEL 051 420 3353**

MILITARY SIMULATIONS
BARBAROSSA JUNE 1941 £17.00
 For those interested in intelligent
 strategy wargames.
 Sent S.A.E. for details to:
K W Software
**155 Ringinglow Rd,
 Sheffield S11 7PS**

SUPER SOUND 1V
 "Super Sound is the best quality and value
 for money sampling program you
 will find anywhere!"
93% CU Amiga July & September 1993
KBE SOFTWARE
 8 Church Street,
 Kingsley,
 Staffs ST10 2AA
 Tel/Fax: 0538 757400

100'S OF AMIGA AND ATARI ST/E
 Games, Utilities, Music.
 Ham Radio plus many
 more AT JUST **90p**
 SEND NOW FOR FREE LISTS AND
 ORDER FORM. NO OBLIGATION.
**PENGUIN PUBLIC DOMAIN,
 PO BOX 179, READING
 BERKS, RG3 3DD**

ESSEX LASER SERVICES
COMPUTERS & PRINTERS
AT CRAZY PRICES
A600 £183, 40Mb £310, 85Mb £375
A1200 £280, 30Mb £370, 85Mb £479,
209Mb £579 A4000 PRINTERS - PHONE
FOR BEST PRICES PHONE (0473) 652590

GAMES GROTTA
 Game exchange, Sega and
 Nintendo from £3.00 +P+P.
 Amiga/PC PD Catalogue disk only £1.00
 PD Software 99p per disk. Budget games from
 only £4.99
 Latest titles always in stock.
**132 Derby Lane, Old Swan,
 Liverpool L13 3DW.
 Tel 051-252 1020**

WANTED
DEAD OR ALIVE!
AMIGA A500 COMPUTERS
 WORKING OR NOT WORKING
 ANY CONDITION ACCEPTED CASH PAID!!
TEL. SOUTHEND 0702 207593
 COMPUTERS CAN BE COLLECTED FROM YOUR DOOR!
 SORRY BUT SOFTWARE & ACCESSORIES
 ARE NOT REQUIRED

THE VERY BEST AMIGA USER GROUP
 Offering thousands of new contacts. Free help and
 advice, second-hand hardware and software
 bought/sold/exchanged. Exclusive massive club discounts
 Latest product information and member reviews. Plus
 the best fan/diskzines and millions of PD/Shareware
 titles. For Free information pack send an SAE to:
CHIC COMPUTER CLUB (AF)
 P.O. Box 121, Gerrards Cross, Bucks SL9 9JP
 (0753) 884473.
 Trade & Dealer enquiries welcome. Plus FREE publicity for new
 software/fanzines etc. Contact us now!

Jorvik PD
85 Hemlock Avenue, Huntington, York YO3 9DG.
Tel (0904) 624637 (evenings)
 Catalogue 3x 2nd class stamps. PD Disks from 30p
 Blank disks plus a label (DSDD) 39p.
 Mouse Mat £1.99
10 Capacity Box £4.99
 first class postage included.
 Please make cheques/postal orders payable to
 D. Bateman. (AF/11/93)

KT's PD (software)
Amiga 500/500+/600/1200
 Fast and friendly service.
 Over 4,000 titles from stock (24 hour despatch)
 We stock all fish, Scope, Assassin Official CLR Distributors
 Disks from 80p.
 Send 60p plus SAE for your catalogue disk to:
**KT's PD software 75 The Drive, Rochford
 Essex, SS4 1QQ Tel: 0702 542536 (anytime)**

WESTMAN COMPUTERS
**3 Brewhouse Yard,
 Gravesend, Kent, DA12 2EJ**
0474 535266
 Trade prices available on
 Software, Disks, D-Boxes, Joysticks,
 Mouse mats, Cables, Dust covers
 and all computer accessories
Send for catalogue

Amiga-64-Link

- Links C64 peripherals to Amiga parallel port
- C64 **Not** required

Connects C64 printers to the Amiga

- Supports MPS, DPS, VIC, Star, Brother, Seikosha & Citizen printers
- Graphics output on dot-matrix printers
- Works with all software

Transfers C64 disk files to the Amiga

- File transfer programs
- Read/Write text, binary & program files

Standard "Ami-64-Link" £35.25

Prices include VAT and delivery

Budget "Ami-64-Link" £23.50

Budget stops multi-tasking during printing

Amiga
York Electronic Research (0904) 610722
The Paddocks, Jockey Lane, Huntington, York YO3 9NE



BUS STOP PD

Dept AF, 6 Smiths Avenue, Marsh, Huddersfield
HD3 4AN Tel: 0484 516941

RUN BY WOMEN FOR THAT BIT MORE!

GAMES

Wibble World Giddy
Pacman
Dr Mario
Scrabble
Scum Haters
Fighting Warriors
Adventures
Tetris
Top of the League
All Rounder
Strikeball
Kleikris
Black Belt
See Heist
Fruit Salad
Mad Bomber 2
Crove
Bingo Caller
Space Cleaner
Bus Stop Games

UTILS

A500+ Emulator
Printer Drivers
MenuMaker
Icon Editor
Mod 3.20
Clumpy Icons
Ed Word
D Paint Fonts 1-10
Modem Utilities
Font W/Shop
Dream Utilities
A-Graph
Beginners Bench
Mary Sid 2
Slideshow Maker
Print a Card
Birmaster
Bus Stop Utilities 2
No Errors
DCA Backup

ANIMS/SLIDES

Aliens
Flatliners
Rocky Horror Show
Dolphin Dreams
Who R U Lookin' At
Manga Demo
Revelations
Bruce Lee
Lamborghini
MUSIC
Guns N Roses
Iron Maiden
Magic Roundabout
Amigadeus
100 C64 Tunes
Pet Shop Boys
Piano Classical
Deepcore

Techno-A-Takk

Janet Jackson
Napalm Death
Van Halen
Yamma Yamma
Cherokee
Dance Diverse
Keyboard Samples
Voice Samples
Cartoon Sounds
Drum Samples
World of Amiga '92
1200 SPECIALS
Classic Patches (2 Disks)
Workbench Hacks
Fakemem
Workbench Backgrounds

Large selection of education and glamour. Lots of fonts and clip art.
• All disks •
500+/600/1200 compatible.
Also, cheap accessories and second hand games.

Cheques payable to:
BUS STOP PD

ONLY 85p per disk!

P&P 50p per order. 24 Hour service. All disks virus-free. Catalogue 50p+ SAE - OVER 1300 TITLES.

100 BLANK DISKS FREE GRAVE YARD P.D.

As an opening offer G.Y.P.D. are giving away 100 BLANK DISKS and a pair of SCREEN BEAT stereo speakers to the lucky person who becomes the first member of G.Y.P.D. There are also 50 BLANK DISKS to be given to every 100th member i.e. Member No. 100, 200 etc, so as to give you all a chance to win.

MEMBERSHIP BENEFITS

All P.D. disk prices 99p + free disks for larger orders. Regular newsletters with reviews on new and old P.D. Competitions to win P.D., blank disks and accessories/hardware. Special blank disk prices for club members. On sending your membership fee you will receive your membership card, catalogue disk, newsletter and priority order form.

MEMBERSHIP FEE:

To enrol as a member send your name & address along with £4.99.
OR SEND £9.99 AND RECEIVE OUR TOP 10 P.D. DISKS

Please send P.O. or CHEQUE made payable to
GRAVE YARD PUBLIC DOMAIN
31, CLEMENCE STREET, LOWESTOFT, SUFFOLK NR32 2JJ

..AT LAST IT'S HERE!

COMPUTE-A-RACE+..£19.99 THE FINAL EDITION

After 3 years of development Compute-A-Race+ - The Final Edition has finally been released.

WHAT DOES IT DO?

Compute-A-Race+ is a Horse-Racing Prediction Program that can forecast races, select bets, calculate return and much more.

IS IT COMPLICATED TO USE?

No. Features an ease of use. Within days inputting a race will be second nature.

WHEN SHOULD I ORDER?

Now. For a limited period we are providing 'personalised' Master Disks (please include full name with order).

Cheques/P.O. payable to
HANDISOFT (Mail Order ONLY)
Handisoft, 37 Hearsall Lane,
Spon End, Coventry CV5 6HF

MICROLAND BULLETIN BOARD SYSTEM

0891 990 505
To Download

0483 725 905
To View

Amiga shareware including files from the Fred Fish Collection plus lots more to download at V32bits, V32, V22bits, V22, V23, & HST 8 data bits, no parity.

Calls to 0891 990 505 charged at 36p per minute cheap rate, 48p per minute all other times. Trevan Designs Ltd.
PO Box 13 Aldershot, Hants GU12 6YX

★ GAMES ★ ★ PROGRAMMERS ★

URGENTLY REQUIRED for work on SEGA, NINTENDO, AMIGA etc. Both Permanent and Contract positions available at various organisations based throughout the UK, including: Yorkshire, North West, Midlands, London etc.

If you have one year or more games programming experience and are looking for a career move with excellent prospects then contact:

STEPHEN DAVIES, GAMES RECRUITMENT SPECIALIST on
(0709) 571441 or Fax (0709) 586527.

Alternatively send a CV to: **AARDVARK SWIFT LTD (GAMES DIVISION), 75-77 STATION STREET, SWINTON, SOUTH YORKSHIRE S64 8PZ**

ARTWORKS CLIP ART

Original images for the computer. NOT public domain

Each disk contains between 115 and 270 original, high quality, images for use with Amiga Art, DTP & video programs - Deluxe Paint, Pagesetter, Pro Page, Pagestream, Wordworth, Penpal, Scala etc.

1. Pets
2. Castles, cottages & churches
3. Trees
4. Signs & symbols
5. Wild animals
6. Prehistoric life
7. Signs & symbols 2
8. Weddings & family occasions
9. Fishing & freshwater life
10. Signs & symbols 3



£7.99 each - 3 or more £7 each - Over 1700 images for only £70 - Inclusive of 1st class P&P.



AMIGA COMPUTING - "Best Buy"
CU AMIGA awarded ★★★★★ - AMIGA FORMAT 85%

Please make cheques/PO's payable to ARTWORKS

(Dept AF) 1 Pond View, Wootton, Ulceby, S.Humberside. DN39 6SF ☎ 0469 588138

Amivision Software present

FORMULA ONE CHALLENGE v4

An incredibly addictive and detailed Formula One simulation for 1 to 4 players.

Watch the races as they unfold with three levels of highlights. Crashes, spins, pile-ups, car failures, stop/go penalties, weather changes, fastest & record laps, make pitstops. Four independent levels of difficulty. Accurate and detailed graphics of the teams, circuits etc.

15 teams, 2 cars per team, 50 drivers with varying skills, complete engine & tyre contracts. Choose tyre compounds, tune your engines, change wing settings, even train your pit crew! Qualifying, 16 accurate championship circuits, news section, realistic sound fx, load/save games, weather forecasts, statistics saved, latest FISA rules, sponsors, full drivers and constructors championships and so much more.

Includes full 1993 season. Details can easily be updated each year.

Incredibly addictive, produced by true Formula One fans.

This is the most realistic Formula One simulation, guaranteed.

JUST £14.95!
INCLUDES INSTRUCTION MANUAL

DEMO DISK C1

A1200 compatible

PLEASE MAKE CHEQUE/POSTAL ORDER PAYABLE TO: S. RENNOCKS

Dept. AF, 1 Cherrington Drive, Great Wyrley, Walsall WS6 6NE

WHY NOT JOIN THE GUILD OF PROFESSIONAL VIDEOGRAPHERS. WE CAN OFFER AMIGA AND VIDEO TRAINING COURSES AT REASONABLE RATES AND MUCH MORE BESIDES. SEND FOR INFORMATION PACK TO THE GUILD OF PROFESSIONAL VIDEOGRAPHERS



11 TELFER ROAD
RADFORD, COVENTRY CV6 3DG
OR PHONE/FAX 0203 601966

OVER 2000 GAMES

IN-STOCK TODAY - FROM £2.99:

IN A HIGH STREET NEAR YOU

TOP TITLES... Football Manager 2, Dizzy, Pro Golf, Pro Tennis, Kickstart 2 and thousands more.

FOR... Amiga, C64, Spectrum, Atari ST, IBM/PC and Amstrad.

AVAILABLE NOW AT...



John Menzies

and leading computer retailers.



Phone
0782 566566
for your nearest
High Street stockist

or write to: Software On Demand Ltd, Unit One, Rosevale Business Park, Newcastle Under Lyme ST5 7QT

AMIGA REPAIRS

FIXED CHARGE ONLY £42.99 Incl.

- FIXED CHARGE INCLUDES PARTS, LABOUR, DELIVERY, VAT
- 90 DAY WARRANTY ON ALL REPAIRS
- 24 HOUR TURN-AROUND ON 95% OF REPAIRS
- ALL UPGRADES PURCHASED FROM US FITTED FREE WITH REPAIR
- INCLUDES REPAIRS TO DRIVE & KEYBOARDS, ADD £10.00 IF NEED REPLACING, FULL DIAGNOSTIC TEST AND SERVICE

Est.
12 Years

In Stock SPECIAL OFFERS New Low Price

INTERNAL 3.5" DRIVE <i>Simple to fit, fully documented</i>	£38.99	A500 MODULATOR <i>Exchange/Repair</i>	£18.00
ROM SWITCHER <i>Keyboard/mouse switched</i>	£14.95	A500 KEYBOARDS <i>Factory new, Genuine part</i>	£44.10
KICKSTART 1.3 ROM <i>For software compatibility</i>	£25.00	FATTER AGNUS 8372A <i>1 Meg chipram compatible</i>	£36.50
KICKSTART 2.05 ROM <i>Upgrade to A500+ ROM</i>	£29.90	CIA IC <i>Printer, Serial, Drive ports</i>	£9.20
SUPER DENISE <i>Excellent value</i>	£28.70	GARY IC	£11.50
68000 CPU	£15.00	PAULA IC	£19.95
		DENISE	£19.95

ATTENTION ALL DEALERS

Our company now offer the most competitive dealer repair service.
Full credit facilities available.
Send for our FREE information pack today...

We reserve the right to refuse repair for whatever reasons
Prices only valid with this coupon

Service HOTLINE (0533) 470059

DART Computer Services
105 London Road
LEICESTER LE2 0PF

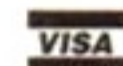

DART
Computer Services

PREMIUM BULK 3.5" DS/DD DISKS

25	10.49
50	18.49
100	32.99
200	64.49
250	79.99
500	158.99



ALL DISKS ARE FULLY GUARANTEED AND ARE COMPLETE WITH LABELS

3.5" SUPERIOR LOCKABLE DISK BOXES

Qty	100 Cap.	140Cap.	Bank Box
1	4.49ea	6.49ea	9.95ea
2	4.39ea	6.39ea	9.75ea
4	4.19ea	6.19ea	9.50ea
6	3.99ea	5.99ea	9.25ea

3.5" PREMIUM DISKS WITH OUR BOXES

100 Cap box + 50 3.5" DS/DD	22.49
100 Cap box + 100 3.5" DS/DD	36.49
140 Cap box + 100 3.5" DS/DD	37.99
80 Cap Bank box + 50 3.5" DS/DD	27.49



SNAP
COMPUTER

SUPPLIES LTD

HOTLINE

0703
457111



RIBBONS-POST FREE

Full Mark Brand	2 off	4 off
Citizen 120D/124D Swift 24	2.75	2.55
Citizen Swift 24 Colour	11.95*	
Panasonic KXP 1080/1123/1124	3.25	3.05
Star LC10/LC20	2.60	2.40
Star LC10-4 Colour	5.90	5.70
Star LC24-10/24-200	2.95	2.75
Star LC24-10 Colour	9.95*	
Star LC200	3.00	2.80
Star LC200 Colour	9.95*	
Star LC24-200 Colour	9.95*	
Ribbon re-ink	12.95*	

COMPATIBLE INK JET REFILL
HP Deskjet 500 Double Refill 9.95*
Canon BJ10E Double Refill 9.95*

Minimum order - 2 ribbons, except those marked with an asterisk*

ACCESSORIES-POST FREE

Mouse Mat	2.99
Mouse Holder	2.99
Roll 1000 3.5 Disk Labels	8.99
Amiga A500/A600/A1200 Cover	3.50
Philips monitor cover	3.99
Star/Citizen/Panasonic 80 col. Printer cover	3.99

All products are subject to availability - All prices include VAT.
Please add £350 ptp for disks and boxes. E&OE.

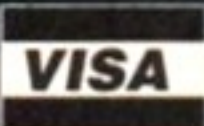

SNAP COMPUTER SUPPLIES LTD Fax: 0703 457222
Unit 16, The Sidings, Hound Rd, Netley Abbey, Southampton S03 5QA

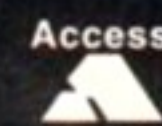

A WORD FROM THE ED



We were deluged with calls on Tuesday August 31st, mostly from people eager to tell us they had seen a CD³². Not only that, but on sale in Rumbelows to boot! It was rather like people writing to the Times to report hearing the first cuckoo of spring.

One particularly unfortunate bloke was so eager he actually went in and bought one. He was very happy with his new purchase until he got it home and opened it. Inside the box was one perfectly lovely CD³², a manual, a joystick and a power supply. And that was it. No software.

We told him that we had seen several items of software that were complete, and that it would only be a matter of time before they would be pressed up and in the shops. Not surprisingly, after just spending £300 on a games super-machine, our caller wasn't too consoled by the prospect of simply sitting and staring at his new toy for a few weeks.

Commodore promised us 18 games at launch for the CD³². They haven't delivered. No one is less surprised than us. And no one is more disappointed than us (except maybe the chap who bought his CD³² today).

Commodore can't afford to mess this one up. It would be better to release the unit a few weeks later with software than earlier without. CD³² needs a good reputation, and it's already been tainted the day it went on sale.

Letters

Have your say! Make your point! Get heard! If you feel a need to share your point of view with other Amiga users, or you just have something witty to say, then write to: Letters to the Editor, Amiga Format, 30 Monmouth Street, Bath, Avon BA1 2BW.

SKID MORE

There I was, reading the October issue of *AF*, wondering where I was going to get the cash for an A1200 or CD³². I then put in the Coverdisk and loaded the *Skidmarks* demo. All thought of an A1200 vanished as the gameplay smacked me in the teeth. This is what we want, pure fun! Once I had sussed the controls the computer cars were easy to beat, best lap 10.2 seconds.

So I went and got my mates, and a few beers later we were trying to blow each other into the weeds. The two player option is great, but what about a serial link? I think a lot of games programmers would be surprised to discover the amount of people who link up Amigas. How could MicroProse make such a stunning game as *FIGP* and not offer a serial link? We regularly play *Vroom*, *Lotus* and *Stunt Car Racer*. Is *Skidmarks* going to be a full game? If so how do I get hold of it?

On the subject of Shareware, you said Mark Sibly was disappointed with the response to *Cybernetix*. But Jeff Minter and Bryan Bell got good responses to *Llamatron* and *Charlie Chimp* by offering a second disk to people who registered. This is the only way to make Shareware work.

If Vision had put out the demo of *Skidmarks* and then asked for a fiver or a tenner for the full game I bet they would have been swamped with replies. Since *Blitz Basic* is going to be on the Coverdisk next month (see front cover - Ed), what about Vision

offering the source code to buyers of *Skidmarks* for, say, an extra fiver on the price?

G Smiles, Midlothian

Skidmarks surely will be a complete game, and we'll give more details of how you can obtain it as soon as a distributor has been sorted out.

We agree entirely about it being a great two-player game, and a serial link would make it better still. But the guys at Vision know what they're doing and the full version will have a serial link option, plus monster trucks that bounce and 10 tracks of racing mayhem!

As for Vision releasing the source code... you'll have to ask them about that.

NO TRADING

In October 1992 you reviewed *Traders* and to quote you: "If there's nothing else you fancy on the shelves this month, you could do a lot worse than this". I tried every week until Feb 93, when I finally contacted your mag since the reply I kept getting was 'It hasn't been released yet'!!!

It is now almost September 93, a year later and I am still trying to get a copy. You say your policy is that you don't review a game until it has been released. Then *Traders* should be on sale somewhere.

Any ideas where?

Mrs C Cramp, Aldershot

We don't claim to only review games when they are released, never have! What we say, and adhere to, is that we don't review a game until it is complete. *Traders* was

complete, and the company Linel supplied it to us for review, prior to its release. We gave it a favourable review, but they decided it would not sell, and so they didn't release it. Were they wrong?

Write and tell the development house, Digital Integration, if you want to see *Traders* on the shelves. Contact them at:

Watchmoor Trade Centre
Watchmoor Rd
Camberley
Surrey GU15 3AJ.

WE'RE FAMOUS

PRIZE

I know that you don't want any more letters about Amigas on TV, but I was wondering if you noticed that the May *Amiga Format* recently appeared on BBC1.

It was on Saturday 21st of August about 8pm. The magazine was on one of those newspaper stands that are often found in railway stations, which was in the background of a scene being shown to advertise a program coming soon. Unfortunately the program looked terminally dull - perhaps they used *Amiga Format* to brighten it up a bit. Do I win a prize for my amazing observation?

Neil Adams,
South Woodham Ferrers

This has to go under 'unconfirmed sightings' because no-one we know actually saw it, but then on a Saturday, they'd all be out partying. So we'll give you the benefit of the doubt. An AF T-shirt and pin-badge are on their way to you.

Continued overleaf

The Amiga Format Gallery

Sponsored by MAX Graphics

Got a picture you're proud of? Send it in, see it in print and win an Amiga Format binder! Since Letters is where you get to contribute your words, we thought it would be the perfect place to see your pictures on display too.

The best image each month will win a huge (and we're talking big) poster print-out, courtesy of Max Graphics of Cardiff - worth a massive £80. Send your entries on a floppy disk to The Gallery, Amiga Format, 30 Monmouth Street, Bath BA1 2BW.

If you need your artwork printed out, give Max Graphics a call on 0222 522332, or write to them at 168 North Rd, Cardiff, CF4 3BJ.

They offer a full range of Amiga output services, including their Colossal Colour system which can print images right up to poster size.

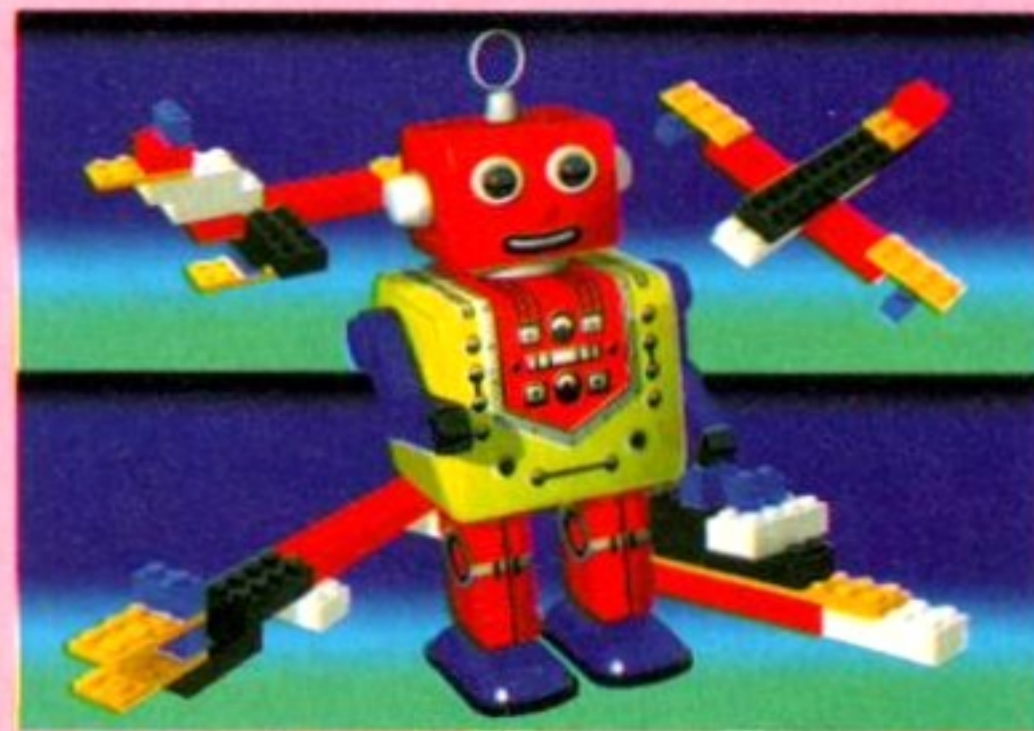

Robot by Chris Tucker of London.



Amy by Paul Horton of Stretchford, Birmingham.



Boat by Martin Welsh of London.

The Gallery
Sponsored by
MAX
Graphics

S.W.I.V. IS OK

In the September 1993 issue of *Amiga Format* it was mentioned in the 50 Golden Greats feature that S.W.I.V. was never updated to work on the A500 Plus, A600 or the A1200. However I own an A600 and have been able to enjoy playing it for months! I will point out that it isn't a pirate copy, it's 100 per cent original. Has anyone else with the above machines noticed the same?

Karl Steward, Norfolk

Rumour has it that there is an ECS-friendly version of S.W.I.V. in existence, but no matter how hard we try to get hold of a copy, we can never manage. And being the fierce empiricists we are, we won't believe it until we've played it.

From what we've heard, and since we don't have a copy we can't test it ourselves, the ECS version doesn't work on an A1200.

S.W.I.V. RETURNS

In the March issue you said *Kick 1.3*, the disk that does the same job as a ROM sharer, would not work on the A500 Plus. In the September issue, you said that the classic shoot-em-up S.W.I.V. would not work on a Plus or A600 and so was dead.

Have I got news for you! If you run *Kick 1.3* (available from PD libraries) on your A500 Plus or A600, you get a message saying 'Unable to load KS 1.3 Plus: error code 121'. But take out the disk and reboot, and you now get the Kickstart 1.3 boot screen. Now you can play all those old classics that did not work before!

Jamie Hatswell, St Davids, Pembrokeshire

Hmm. Thanks for the tip! We'll really have to give this a try ourselves...

ABANDON (PIRATE) SHIP

PRIZE I am a 14-year-old kid who has read a lot about piracy in magazines. Firstly I would like to say that one of the reasons the Amiga is selling so well as a games machine is that people don't have to pay that much to play a game. What I mean is that someone can grab a program like *X-Copy Professional* and a few empty disks and instantly copy a game (unlike console owners). This is exactly why I bought my Amiga.

But after two years of reading your truly excellent magazine, I am slowly starting to realise what piracy is doing to the Amiga. I bet you that every single Amiga owner has a least one pirated game or program. I mean let's face it, you have £18 pocket money and are dying to buy a game when one of your friends has a cracked version, surely you're going to copy it. And then maybe buy it when you have enough cash.

I get £8 a week and that means that if I want to go to the cinema, go swimming, get a burger and buy *Amiga Format* as well, I really don't have enough left to buy games. How am I supposed to play the same game for two or three months without getting bored?

My parents only buy me serious programs, so it seems piracy is a must for someone my age. Unless you play demos from magazine Coverdisks, which is exactly what I've been doing since I began to wise up.

I hope software houses start selling good games for low prices, because nobody wants the Amiga to die.

Nabil

I know you might want to remain anonymous because of your now-abandoned pirate ways, but if you send us your address you can have a year's free subscription to Amiga Format. That should free up a bit of your pocket money to spend on some of the fabulous games that are available on budget these days.

Just look at this month's budget pages: you'll see Shadowlands, Midwinter 2 and Super Space Invaders all on offer for bargain prices. And keep playing the demos: last month's Skidmarks really is excellent fun in two-player mode (the computer cars are too slow to offer any real challenge), and this month's Zombies and Defender are superb fun.

MORE ANON

PRIZE This letter is to thank Anon from Issue 50's Letters pages. Following his example I have wiped my entire pirate collection (all thirty or so disks) and have vowed never to trade copied disks again.

However, I have a few questions. Would disks labelled with the names of games be enough to arrest someone? Can you be arrested if you dob on friends and they accuse you, even if you have no disks left?

Thirdly, why is ELSPA so hypocritical? First they tell us piracy is a bad thing, then they ban magazines from putting age-old games on their covers. The prospect of *Kid Gloves* or *Bombuzal* ruining major companies like Ocean and MicroProse is risible.

Banning such games is similar to banning Public Domain. The release of *Bug Bash*, an old full pricer, on Licenceware shows that old games on Coverdisks are harmless, if not beneficial. An extra game on Coverdisks means that people don't need a pirate game.

Perhaps if the big companies released more of their games at £2.99 or as Licenceware, and FAST kept its nose out of harmless media, and the police teamed up with the Post Office and Telecom to find the owners of PO boxes and BBSs which convey pirated material, then the world would be a better place.

Another Anon

You too can have a free sub if you just send us your name and address. Don't worry, neither we nor FAST are interested in the prosecution of ex-pirates. In fact I am sure that, like us, they would congratulate you on your decision.

As for the placing of games on magazine Coverdisks, that is an area where ELSPA (for it is they, not FAST, that ban that particular activity) and we do not see eye to eye. ELSPA believe that people only have a certain amount of time every month to dedicate to playing computer games, and that if they receive a freebie on a magazine they will not buy a game that month. We believe that people only have a certain amount of money to buy games, and that if they can't afford all the games they want, some people will pirate the ones they can't afford. But ELSPA is made up of all the top software companies, and they threaten to stop sending us games to review and to pull their advertising if we give away complete games.

Some magazines have begun to ignore this ban, though, and play tricks to get full games on their Coverdisks. If the ELSPA members expect their ban to be taken seriously, they will have to take sanctions against these magazines.

All in all, keep up the good, non-piracy, work and use coverdisks and budgets to feed your game playing needs.

MINISTRY OF NOISE

While I was listening to one of my heavy metal tapes I realised that the words to one of my favourite songs is a cheat to *Sleepwalker*. Near the start of *Jesus Built My Hotrod* by Ministry

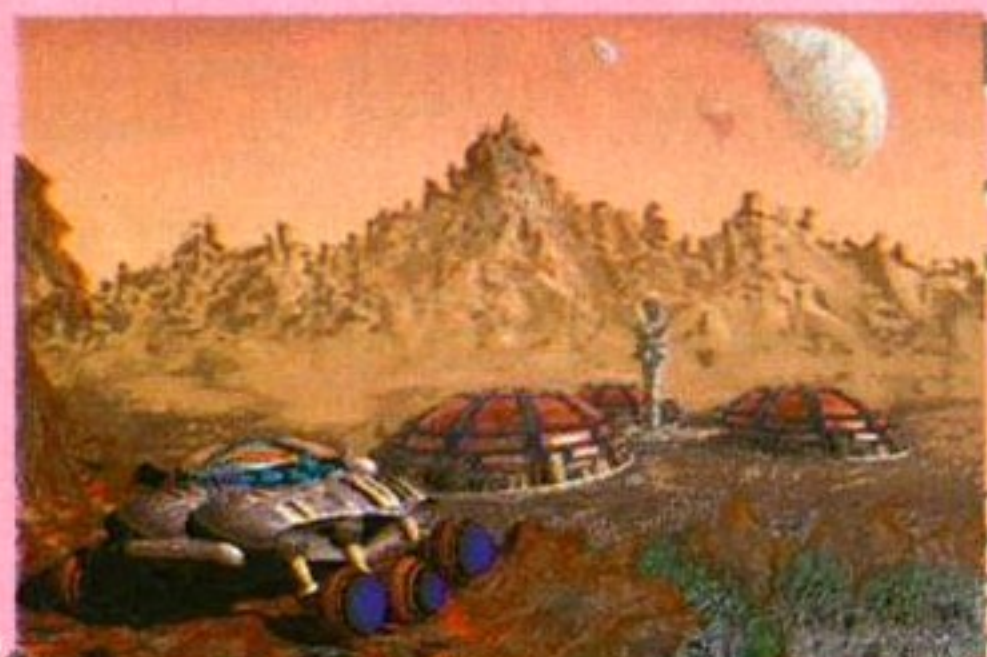

Colony by Walid El-Azem of Playa Honda, Lanzarote.



Dragon by Jonathon McBrien of Enniskillen.



River by Paul Hamilton of Exeter.

there are the words "Dingading dang my dangalong ling long". Which is the cheat, isn't it?

Damen Smith, Potters Bar

Yes! yes! yes! The 'my dingaling a ding dang thing' thang is indeed a lyric from that song. But it isn't heavy metal. The guys who coded Sleepwalker, John Scott and Dave Pratt, are big fans of Alien Jourgensen's group Ministry.

SCRIBBLINGS

Way back in Issue 41 you gave away *Scribble!* on the Coverdisk. On the disk pages for this brilliant program there was a box called 'Expansion Potential' which said that you had arranged with HB Marketing to supply a supplementary disk with the spell checker and thesaurus and a full manual for just £9.99. Is this package still available and if so, how do I get hold of it? I rang the phone number in the mag and the line seems to be unobtainable.

Neil Lomas, Barnsley.

As you state, that deal was offered "way back" in Issue 41. And sadly, HBM who were offering it have since gone out of business, so it's no longer available.

WISE WORDS, MATE

I have read with interest comments by Amiga users who have written to your magazine to complain about Commodore's policy of releasing new machines, thereby leaving them behind in the 'Gee whizz!' stakes.

I feel that I can speak with some authority because I was one of those who bought an A500 Plus two Christmases ago. Since then, I have seen my machine go out of production and be replaced by the A600 at about half the price I paid originally, the A1200 at £100 less and, just recently, the CD³². According to some people I should feel annoyed about all this, but do I? No.

Since I got my machine I have spent a not inconsiderable amount of money on it (all right, a whopping great amount, actually), upgrading it with a hard drive, an extra disk drive, extra RAM, a printer and so on. Despite this significant outlay I do not feel cheated in any way.

I enjoy using my Amiga, and I feel that it is the uses to which you put your computer, rather than the number of colours or the speed, which is the key factor. That's not to say that I would not love to have an A1200 equipped to the same standard as my trusty A500 Plus – it's just that I don't especially need one.

I use my Amiga for playing games (say what you like, but pretty colours don't make a bad game any better – imagination, time and effort count far more). I also use it for word processing, a little DTP and a lot of graphics and programming. I even sent a game of mine in for you to review in your PD pages – *JellyQuest*, available now, arcade/puzzler fans!

There is no need to buy the best equipment just to inflate your ego – with a little imagination, the humble A500 can give you everything you bought a computer for in the first place. Just because there's something better doesn't make what you have any worse.

No matter what your equipment, it's not how big or powerful it is that counts, it's what you do with it, eh! All I'm saying is, the Amiga's still the brilliant computer you bought.

David McGuire, Cumbernauld

Totally right. Our advice is, yes, the A1200 is excellent but only upgrade if you really need to and if you've invested heavily in heaps of extras for your older machine you're almost certainly better off sticking with it.

GO WEST

Could you please help me with a little problem that I have? I really want to create my own text adventures on my Amiga. Do you know of any user-friendly, easy to use and reliable text adventure creators in the public domain? I have tried a couple which, to say the least, were not very fruitful or successful.

William Haycock, Guildford

Strangely, coincidentally, we only recently reviewed the PD text adventure creator FRAC in Issue 47 and it's very excellent. It's PD-Soft Disk V850, so telephone them on 0702-466933.

Continued overleaf

THE MAN AT THE TOP

Keen to increase communication between The Big C and the Amiga community, Commodore UK's General Manager David Pleasance will be replying your letters personally on a monthly basis.



Champagne celebration

Champagne, anyone? Yes, I'm celebrating the release of the new Amiga CD³² console. Commodore have made the move that every Amiga owner has been dreaming of.

The CD³² really does give us something to shove down the throats of our younger console owner siblings, who up to now thought that Sega and Nintendo were the definition of 'video games machine'. Here's to the downfall of the wretched shiny black Japanese cardboard box known as the Mega CD.

I have an A500, and am seriously considering buying an A1200. The price is certainly enticing, but what really excites me is the AGA chip set, and the idea of AGA-only games. After reading about how *Pinball Fantasies* is being revitalised for the CD³², will they also bring out an AGA version for the A1200?

I'm hoping that the CD³² will not mean that programmers forget about the A1200 and stop making enhanced games for it. Or will CD³² mean more AGA games for the A1200?

Steven Laurence, Celbridge

I am reliably informed that A1200 AGA versions of almost all products developed for Amiga CD³² will be released. With Commodore having decided to only market 32-bit (minimum) technology, the publishers are clear about what platforms to support.

More Amigas?

While reading Issue 49 of *Amiga Format* I read, to some confusion, that Commodore are to bring out yet another Amiga, this being the CD-based console thingy. What are they playing at?

I bought my Amiga 1500+ confidently after a friend bought the then-brand-new A500 Plus, only to find that a year or two later our computers are out of production. When the Pluses came out it was said these new models would last for at least a couple of years. Now Commodore have done the same thing with the A600; that has been out for a year and already it is being dropped.

I would like to buy a 32-bit model, but can I trust Commodore to keep one model going for long enough to make it worthwhile?

Alastair Pugh, Norfolk

While I have empathy for your feelings, I must point out to you that technology cannot and will not stand still. Just look at MS-DOS machines, with XT, 286, 386, 486, 586, etc, all being released very quickly in succession and each more powerful a format retailing at less than its predecessor.

The Amiga CD³² is a games console and the A1200 is a home computer. The A4000 has the most powerful chip set available. The choice is yours. 32-bit technology has never been cheaper – don't wait, buy now and enjoy it.



Target Practice by Scott Francis of Kirkcaldy, Fife.

The Gallery
Sponsored by
MAX
Graphics

AMIGA FORMAT

How to contact

AMIGA FORMAT

The best way to get an answer from Amiga Format is to make sure you're addressing your letter to the right person (or indeed department) in the first place...

● We get literally hundreds of letters and faxes a day, so if we were to try and answer them all personally we would never have any time to actually write *Amiga Format*. So we're sorry, but we can't reply in person.

● We are available for enquiries by telephone every Tuesday between 10.30am and 6pm, but please be patient because the lines do get rather busy.

● Our advertising department can help with problems concerning companies who advertise in the magazine if you phone during normal office hours.

● Our subscriptions service and the *Amiga Format* Mail Order department are not in the same building as the magazine itself. Both can be contacted on 0458 74011.

Work BENCH



If you have any problems with the technical side of your Amiga, with hardware or with serious software, Nick Veitch will try to answer you in the mag. Or, if you have any advice for others or any handy tips to share, send it in and you could win a prize.

WORKBENCH, AMIGA FORMAT, 30 MONMOUTH STREET, BATH BA1 2BW.

Game BUSTERS



If you've just found the cheat mode, mapped out the levels or found all the passwords for the latest game, send the info to Rob and you could win a prize. Or, if you're stuck, ask Helping Hand for advice - or solve someone else's problem and win a prize!

ROB MEAD, GAMEBUSTERS, AMIGA FORMAT, 30 MONMOUTH STREET, BATH BA1 2BW.

Readers' LETTERS



The Letters pages are there for you to air your views and share your opinions; please remember not to ask questions that should be in Workbench! Marcus is looking for thought-provoking or entertaining letters, the shorter the better. Prizes are given for the best.

LETTERS TO THE EDITOR, AMIGA FORMAT, 30 MONMOUTH STREET, BATH BA1 2BW.

COMPETITIONS



To enter a competition, write the answers and your name, address and phone number on the back of a postcard or a stuck-down envelope and send it in. We have just changed our rules so that yeach person may enter only once: and, please, do not include entries with letters to any other part of the mag because we'll just lose them.

WHATEVER COMPETITION, AMIGA FORMAT, 29 MONMOUTH STREET, BATH BA1 2DL.

Special OFFERS



If you've ordered something from the *Amiga Format* Mail Order section and you've got a problem, then don't write to our Bath address - instead contact our Somerton address or telephone 0458 74011.

AMIGA FORMAT MAIL ORDER, FUTURE PUBLISHING, CAREY COURT, SOMERTON, SOMERSET TA11 6TB.

SUBSCRIPTIONS



If you move house and want to make sure your copy of the magazine catches up with you, or if you have any other subscription enquiry then write to:

AMIGA FORMAT SUBSCRIPTIONS, FUTURE PUBLISHING, CAREY COURT, SOMERTON, SOMERSET TA11 6TB.

Faulty COVERDISKS



The disks are duplicated and stuck on the magazine by a separate firm which we employ. If you have a faulty disk, DON'T return it to us: send it, enclosing an SAE, to: DISCOPY LABS, UNITS 2 & 3, OMEGA TECHNICAL CENTRE, DRAYTON FIELDS, DAVENTRY, NORTHANTS NN11 5RT.

TV STARS

PRIZE

We thought that you might like to know that we, Dangerous Brothers Inc, have advertised the Amiga on MTV's *Most Wanted* - totally free, of course! This came about when we were watching the program and Ray Cokes said he had just got a fax machine and gave out the number.

Immediately, we jumped onto our Amigas. I, Dee-Rab, set the modem and fax program up while Crazyhorse created a page to send. Within five minutes we were ready to send and soon we connected.

Sixty-two seconds later the transfer was complete. Two videos later Ray was waving our fax about. After a few minutes of babbling about how wonderful fax machines are he read

our fax, and he actually said "Commodore Amiga".

Surely this must be a first, the words Commodore Amiga spoken on international satellite television and the fact that those sacred words were created and sent on an Amiga!

The Dangerous Brothers Inc, Darlington

Nice moving, boyz. T-shirts are on their way. First reader to appear on MTV holding his or her Amiga gets a special prize.

EUROVISION

Is it any use for us outside the UK to enter your competitions? Would you let anyone outside the UK win?

Bjorn A Lynne, Oslo, Norway

Certainly you can. Entry is open to all and below a chap from Paris has won.

COMPETITION WINNERS EXTRA...

SPOT THE SHOT

The winner of Spot The Shot 49 is Ian Allison from Glasgow, who identified the grab as being from *Super Cauldron*. The Spot the Shot 50 winner is Robin Barnes of Sheffield, who correctly spotted that the shot was from *Entropy*. A fabulous *Amiga Format* T-shirt is on its way to both our lucky, lucky winners.

GIMME A TEE

The winners of the Gimme A Tee Competition for Outer Limit T-shirts bearing characters from Amiga games are: J Miller, Anerley, London; Richard Miller, Edinburgh; Kelvin Goodson, Frettenham, Norfolk; SP Williams, Bridgend; Matthew Howell, Morpeth, Northumberland; Ian Phillips, Hulme, Manchester; Camilla Olsen, Nordaas, Norway; F Beechey, Shenfield, Essex; Phil Coles, Whitefield, Manchester; E Carrer, London. The T-shirts of your choice will be with you shortly.

DISPOSABLE HERO

The winners of the *Disposable Hero* Competition are: Fai H Fu, Warrington, Cheshire; Jody Gibson, Ashstead, Surrey; James Sturgeon, Keynsham, Plymouth; Gareth Williams, Carmarthen; Laurence Summers, Eastleigh, Hants; A Berry, Penn, Wolverhampton, K Ausaf, Worcester Park, London, D Carroll, Warrington, Cheshire; Mark Pardoe, Ruscombe, Reading, Neil Inston, Weymouth; Andrew Finney, Bromley, Kent; Andrew Sudbury, London; M Beard, Hartwell, Northants; Russell Elder, Pisle, Scotland; James Beattie, Huntingdon; Richard Seanor, Cuckfield, West Sussex; Jason Carter, Lozells, Birmingham; R Freeman, Brentwood, Essex, Myles Jeffrey, Herne Bay, Kent; David Lovering, Ilminster, Somerset; Simon Embley, Darwen, Lancashire; Michael Hall, Higher Blackley, Manchester; Ben Fryer, West Pennard, Somerset; Philip Freeman, Ipswich; Nicholas Olsen Praestoe, Denmark.

We asked you to tell us how long it took you to complete the first level of *Disposable Hero* on the Issue 47 Coverdisk. Most of the times ranged from three-and-a-smidgeon to four-and-a-bit minutes, although one particularly quick mover claimed to have done it in just over two minutes. Anyway, free copies of the game should be with our winners in the twinkling of a whatsit.

LAWNMOWER MAN COMP

You replied in your droves, but the first answer out of the Editor's extra large hat came from Steve Fisk from Chelmsford in Essex who wins a video of the *Lawnmower Man* film and an exclusive *Lawnmower Man* crew jacket. The nine runners up, who receive videos of the film, are: Petain Nicolas, Reims, France; Vish Patel, Peterborough; Jeff Dixon, Tadcaster, North Yorks; A Finch, Sacriston, Durham; David Martin, Palmers Green, London; J Kerswell, Drayton, Norwich; Martin Maxwell, Ardler, Dundee; Paul Kilby, Cambuslang, Glasgow; Matthew Laye, West Bergholt, Colchester. Don't miss the postman, or, indeed, postwoman.

CRIMEWAVE COMPETITION

Andrew Esson of Binfield Heath, near Henley-on-Thames is the lucky winner and receives a copy of *Syndicate* plus a bumper bag of Bullfrog goodies. The runners up, who each win a copy of *Syndicate* are: Carl Harding, Perranporth, Cornwall; Andrew Ashurst, Driffield, East Yorks, Peter White, Cheshire; James Collett, Godalming, Surrey; K Dugdale, Houghton Le Spring, Tyne and Wear; K Ausaf, Worcester Park, Surrey; Simon Forrester, Avondale Square, London; S Aspinall, Hove, Sussex; Simon Clayton, Newton Abbot, Devon. Your prizes are on the way.

DEMON DRIVER

The 20 winners of the Demon Driver competition to have an IDE hard drive installed in their A1200, complete with a copy of *Civilization AGA*, are: Sue Hornett, Wickford, Essex; Tony Culley, Brixham, Devon; David Darkins, Wymondham, Norfolk; Ian Phillips, Manchester; Clive Willacy, Blackpool, Lancs; SM Bullock, Wakefield, West Yorks; Samantha Innocent, Woodhouse Eaves, Leicestershire, D Hughes, Caergeiliog, Gwynedd; M Donnelly, Uxbridge, Middlesex; Aran Johnson, Horsforth, Leeds; Colin Powell, Belper, Derbyshire; Clive Barnden, Burnley; N Prasad, Walshaw, Bury; Fred Freestone, Wanstead, London; Simon Gordon, Noctorum, Birkenhead; E Varney, Hayes, Middlesex; Benjamin Davies, Essington, Wolverhampton; D Ramsay, Bradford, West Yorks; James McEwan, Loughborough, Leicestershire; Doreen Parker, Hemel Hempstead, Herts. We'll be in touch about your prizes soonest.

THE U.K.'s LARGEST COLLECTION OF FONTS **SELECTAFONT** **THE U.K.'s CHEAPEST COLLECTION OF FONTS**

FIG n MIX
from over 80 Disks in ADOBE or COMPUGRAPHIC Format.
Each Disk contains 12 Fonts and Costs between £1.80 and £3.00

NEWSFLASH
over 250 NEW FONTS recently added.

NEW!
INKJET/BUBBLEJET SERVICE
We guarantee that the PREMIER Ink Refills that we supply will give a better quality output than your Original Cartridge or your money will be refunded

WE ARE THE ONLY
FONT SUPPLIER THAT GIVES A UNIQUE GUARANTEE TO EACH AND EVERY FONT

NOBODY
CAN GET CLOSE TO OUR RENOWNED SERVICE AND TECHNICAL BACKUP

EACH FONT COSTS BETWEEN 15P-25P BEAT THAT!

STARBURST POWERLINER
DANNYS DESIGNERS
HEADHUNTER
CARPENTER

FOR A COMPREHENSIVE PRINTOUT OF ALL FONTS AND DETAILS OF OUR OTHER SERVICES, PLEASE SEND A LARGE SAE WITH 36P POSTAGE. (OR PHONE FOR AN INFO PACK) PLEASE INCLUDE DETAILS OF YOUR SYSTEM AND THE SOFTWARE YOU USE.

Single Refills £6.99 } available in Black/Cyan
Twin Refills £12.99 } Magenta/Yellow/Brown
6 Pack Refills £24.99 } Green/Red/Blue

We also stock a large range InkJet/Bubblejet consumables including Paper/Original Cartridge Labels/Transparencies/Empty Cartridges/Colour Kits

We have used Ink-Jets for 3 years, so we are well aware of customer needs. We also stock a wide range of DTP s/w, and can give superb backup... we use all the s/w that we sell!

SELECTAFONT (DEPT AF)
84 THORPE ROAD, HAWKWELL,
Nr HOCKLEY, ESSEX. SS5 4JT

PHONE AN INFO-PACK SERVICE:
TEL 0702 202835
24 HOUR SERVICE.

Our range of educational subjects now includes:

- GEOGRAPHY
- HISTORY
- ENGLISH WORDS
- SPELLING
- ARITHMETIC
- FOOTBALL
- MATHS
- FRENCH
- GERMAN
- SPANISH
- ITALIAN
- SCIENCE
- SPORT
- FIRST AID
- GENERAL KNOWLEDGE
- ENGLAND
- SCOTLAND
- NATURAL HISTORY

kosmos educational software
the connoisseur's choice

Write or phone for our FREE 16-page colour catalogue of Educational & Leisure Software (State computer type) to:
Kosmos Software Ltd, FREEPOST (no stamp needed)
DUNSTABLE, Beds. LU5 6BA
Telephone 0525 873942 or 875406

kosmos

Access 

MEMORY EXPANSION

1Mb x 1	-80ns	DIP	5.41
256 x 4	-80ns	DIP or ZIP	6.03
1Mb x 4 (44C1000)	-80ns A3000	ZIP	17.63
1Mb x 4 (44C1000)	-80ns Static Col	ZIP	17.63
1Mb x 8	-80ns	SIMMs (GVP)	38.78
4Mb x 8	-80ns	SIMMs (GVP)	146.88
4Mb (1x32)	-70ns 4000/030	72 Pin	152.75

Please phone for the latest prices. VAT included. Delivery £4.70

KINGSWAY UK LTD

Phone 0923 836473 Fax 0923 836474
18 Foxfield Close, Northwood, Middlesex HA6 3NU

Access 

AMIGA POWER SUPPLY £28.99

Genuine Commodore, 1 year warranty. Send us your faulty unit and pay only £18.99. Same day despatch by Parcelforce. Free mouse with each order.

AMIGA REPAIR (A500/A500+ ONLY)

£37.99 Any fault (except keyboard faults) send machine with covering letter and payment. Price includes return carriage, insurance and 3 months warranty

A520 Modulator (exchange only - send your old units)	£19.99	Amiga Mouse	£6.00
1.2 Rom	£15.00	A520 CIA	£15.00
5719 Garry	£9.99	8362 Denise	£7.99
		Amiga internal drive	£34.99

Cheques and postal orders to:
Omnidale Supplies, 23 Curzon Street,
Derby DE1 2ES. Tel (0332) 291219

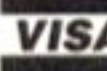
Access 

NCS TEL: 0925 243770
Open 9am-6pm Monday to Saturday

NASH COMPUTER SERVICES

PANASONIC/EPSON
KXP1170 9 pin mono£130
KXP2180 9 pin colour.....£189
KXP1123 24 pin mono.....£165
KXP2123 24 pin colour.....£219
Epson LX400 9 pin.....£119
Epson LX570 24 pin.....£259

SEIKOSHA
Seikosha SP1900 9 pin.....£117
Seikosha SP2400A1 9 pin.....£149
Seikosha SL-90 24 pin.....£169
Seikosha SL-95 24 pin colour.....£195

CONSUMABLES & ACCESSORIES
Dysan Precision Branded Disks
10 x 3.5" DSDD£4.95
50 x 3.5" DSDD£21.86
100 x 3.5" DSDD£39.60
250 x 3.5" DSDD£94.88
1000 x 3.5" DSDD£379.53
40 Cap Lockable Disk Box.....£4.99
100 Cap Lockable Disk Box.....£5.99
Mouse Mats.....£2.99
Mouse House.....£2.99

Ribbons
Citizen 120D.....£2.95
Citizen Swift 9/24.....£2.95
Swift 9/24 Colour.....£9.99
Panasonic KXP1123.....£3.49
Panasonic KXP1170.....£2.95
Panasonic KXP2180.....£4.69
Panasonic KXP2123.....£4.69
Canon BJ10.....£16.50
Canon BJ10 Refill.....£9.99

AMIGA CD32
£279
Call for the latest Information

CITIZEN
Citizen 120D+ 9 pin.....£128
Citizen Swift 90 mono.....£169
Citizen Swift 90 colour.....£189
Citizen Swift 240 colour.....£279
Citizen Swift 240 mono.....£305

Citizen Print Manager enhances the output of standard drivers - make sure you get yours with the starter kit.

CANON
The innovative Canon Bubblejet Printers allow "Laser Quality" 360DPI printing at a fraction of the normal cost

BJ10 ex.....£189
BJ10 Auto Sheet Feeder.....£49
BJ200.....£299
BJ230.....£359
BJ300.....£489

LBP 4 Entry Level Laser Printers (4ppm)
LBP 4 Lite.....£669
LBP 4 Plus.....£825

PRINTER STARTER KIT £5 WITH ANY PRINTER INC CABLE, PAPER (CITIZEN PRINT MANAGER WITH CITIZEN PRINTERS)

P&P FOR HARDWARE £7.00

Suites 3-4, 1st floor, Stanley House,
29 Stanley Street, WARRINGTON WA1 1EZ
ALL PRICES INCLUDE VAT

Access 

The Logic Shop

The Home Computer Specialist

STEVENAGE
22 The Forum
(0438) 354449

PETERBOROUGH
Unit 6 Midgate
(0733) 349696

CHESHUNT
5 Lynton Parade
(0992) 625323

SOUTHGATE
Opp. Southgate Tube
081-882 4942

Before you consult a price list
consult a specialist
10th year 1983 - 1993

Matrix Software Club

Computer Software

Hundreds of programs
at a fraction of the price -
- and we'll buy them back - guaranteed!



- * THE LATEST & THE POPULAR FROM THE TOP PUBLISHERS * FROM BUSINESS TO LEISURE * NO COMMITMENT TO BUY * SUPER GUARANTEED PRICES * QUARTERLY NEWSLETTER WITH REVIEWS, SPECIAL OFFERS, MEMBERS SMALL ADS * FAST SERVICE * NO PREPAYMENT
- * ESTABLISHED 1981 * OVER 3000 MEMBERS

Send S.A.E. or phone (24 Hours) for full information pack. Matrix Computing Services, Dept. AMF11, 2 French's Yard, Amwell End, Ware, Hertfordshire SG12 9HP

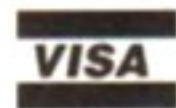

0920 484479 - 24 hours

DIGITALLY MASTERED SAMPLES
IFF SOUND SAMPLE LIBRARIES



Each disk is compiled from a studio quality master and is sampled on the Amiga at twice the sample rate of P.D. sample disks. They are compatible with all P.D. and commercial tracker and sequencer programs. N.B. no. of samples in brackets

001 AFRICAN	Talking drums, Marimbas, chants etc (53)	014 BASS GUITARS	Slap, picked, fretless, FX etc (44)
002 INDIAN INST	Sitars, Bansuri, Chants etc (19)	015 ANALOG BASS	Oberheim, Roland, Korg etc (22)
003 INDIAN PERC	Tabla, Bayas, Rhythm Loops etc (35)	016 DIGITAL BASS	Yamaha DX, Roland, Korg etc (28)
004 ARABIC	Ud, Saz, Bendir, Rhythm Loops etc (37)	017 BRASS	Sections, Saxes, Trumpets etc (24)
005 FAR EAST	Tibetan Bells, Yangqin, Koto etc (31)	018 SYNTH BRASS	Analog, Digital & L.A. etc (18)
006 EUROPEAN	Balalaika, Choirs, Bodhran etc (34)	019 PIANOS	Octave Splits, with strings, FX (16)
007 OCEANIA	Didjeridu, Chants, Slit Drum etc (23)	020 STRINGS	Cello, Orch, Hits, Sections etc (21)
008 AMERICAS	Kena, Berimbau, Pan Pipes etc (30)	021 SYNTH STRINGS	Analog & Digital (19)
009 FX PERC	Power Toms, Snare, Scratch & Rap (88)	022 CHOIRS	Mixed Choirs, with Bells & Synth (16)
010 DRUM KIT	Bass & Snare, Hi-Hats, Cymbal & Toms (63)	023 ORGANS	Church & Electric (17)
011 ANALOG PERC	TR-808 CR-78, Loops etc (30)	024 BELLS	Real & Synth, with Choir & Strings (20)
012 LATIN PERC	Timbales, Congas, Cabasas, Cowbells etc (107)	025 SOUND FX	Action Sounds, Explosions, Gunshots etc (30)
013 GUITARS	Acoustic, Electric & Distorted etc (41)		

Each disk is priced at £2.50, any 10 for £19.95, the Complete Collection for £49.95. In addition, Sampler owners can use our Digitally Mastered Chrome, Metal, or DAT sample Cassettes which contain most of the above samples: COO1 WORLD MUSIC COLLECTION (175)

COO2 PERCUSSION COLLECTION (228)

P&P £1 (any order) Cheques & P.O.s to:

COO3 GUITARS AND BASSES (161)

WALKABOUT MUSIC (Dept AF)
TRENOVISSICK FARM, THE MOUNT, PAR.
CORNWALL PL24 2DA
Tel (0726) 813807

Each Chrome £9.95, Metal £11.95, DAT £16.95

The Three Collection Package is priced at:
£21.95 (Chrome) £25.95 (Metal), £38.95 (DAT)

ONLY A CALL AWAY - THE COMPLETE CONTROL HOTLINE

ONLY £1
for an entire
cheap rate call

Each phonenumber carries just under three minutes of solid tips - no waffle, just pure essential playing guides on the game of your choice. 12 games tipped this month!
NB: Please get permission from the person responsible for paying the telephone bills before you call.

NOW WITH ADDED PHONELINES!

- 1 SYNDICATE**
Tel: (0336) 420363
Crime can pay. Tim Tucker explains.
- 2 GUNSHIP 2000**
Tel: (0336) 420353
Helicopter action with Stuart Campbell.
- 3 DUNE 2**
Tel: (0336) 420354
Mark Winstanley's spicy suggestions.
- 4 DESERT STRIKE PRO**
Tel: (0336) 420352
Advanced tips with Mark Winstanley.
- 5 REACH FOR THE SKIES**
Tel: (0336) 420364
Fly higher thanks to Tim Tucker.
- 6 ARABIAN NIGHTS**
Tel: (0336) 420365
Stuart Campbell gets through the night.
- 7 DESERT STRIKE**
Tel: (0336) 420356
Kick ass in the Gulf. We show you how.
- 8 B17 FLYING Fortress**
Tel: (0336) 420361
It's bombs away - so phone today.
- 9 THE CHAOS ENGINE**
Tel: (0336) 420351
Let's make some order out of it.
- 10 WING COMMANDER**
Tel: (0336) 420358
'Wing' this number for the toppest tips.
- 11 WALKER**
Tel: (0336) 420362
It's the walking, talking, killing advice.
- 12 PREMIER MANAGER**
Tel: (0336) 420355
The number one football hints around.

Calls cost 36p per minute cheap rate (6pm-8am and all weekend), and 48p per minute at other times. Maximum call costs £1.34.

ADVERTISERS INDEX

17 Bit Software	165	0924 366982	Matrix Leisure Services	192	0920 484479
1st Computer Centre	34-35	0532 319444	Microcentre	171	0924 201953
ACS Electronics	152	091 455 4300	Microdeal	181	
Activision	61		Micromania	164	021 559 1002
Amiga Format Special	72-73	0225 442244	Millenium	31	0223 844894
Amiga Power	83	0225 442244	Nash Computer Services	191	0925 243770
Amiga Shopper	125	0225 442244	New Horizon	126	0989 750260
Analogic Computers	170	081 541 4671	Ocean Software	75, 196	061 8326633
Anglia PD	152	0394 283494	Omnidale Ltd	191	0332 291219
Ashcom	89	0530 411485	Owl Associates	176	0543 250377
Brighton Computer Supplies	160	0273 506261	PD Soft	155	0702 466933
Calculus	65-67	0543 251275	Phoenix Computer World	56-57	0532 350091
Cumana Ltd	20	0483 503121	Planet Data	111	0234 240954
DMA Design	111		Post Haste	106	0227 764204
Dart Computer Services	186	0533 470059	Power Computing Ltd	2-3, 6	0234 843388
Datagem Ltd	132	081 608 0624	Premier Mail Order	170	0268 271172
Datel Electronics	194-195	0782 744707	Pyramid Leisure	21	
Digital Multimedia	87	081 977 1105	Saitek	14	
Direct Computer Supplies	128	0630 311471	Seasoft	164	0903 850378
Direct Software Ltd	123	0908 379550	Selec Software	176	061 428 7425
Diskcovery PD	163	0274 880066	Selectafont	191	0702 202835
Eagle Software	150	081 361 5730	Sidmouth Software	171	0395 67073
European Computer User	81	0480 498889	Silica Systems	113, 131, 141, 147, 167	081 309 1111
Express PD	164	0533 887061	Siren Software	13	061 7247572
Firecrest Distribution	175	0875 850028	Snap Computer Supplies	186	0703 457111
Fujitsu	17		Softler Software	164	010 468 749 0806
Future Books	144, 146	0225 442244	Software Demon	90-91	0736 331039
Future Entertainment Show	93-95, 98, 149	0225 442244	Software On Demand	186	0782 566566
Future Music	139	0225 442244	Softwood Software	85,99	0773 836781
Gamesmaser	84	0225 442244	Special Reserve	24-25	0279 600204
Grapevine Group Inc	176	(914) 3572424	Talking Birds	171	0702 523607
Harwoods	43-45	0773 836 781	Teque London	111	081 983 4147
Hobbyte	76-77	0727 56005	The Jumping Bean Company	69	0602 792838
Indi	49-53	0543 419999	Trilogic	102-103	0724 691195
Kingsway UK Ltd	191	0923 836473	United PD	158-159	0983 529549
Kontax	175	0628 773212	Virus Free PD	157	0793 512073
Kosmos	191	0525 873942	Voithia Software	175	
LCL	176	0491 579345	WTS Electronics	142-143, 160	0582 491949
Logic Sale	191	0992 625323	Walkabout Music	192	0726 813807
Mail Order Express	92	0924 422057	We Serve	124	0705 325354
Market Place	184-185	0225 442244			

AMIGA FORMAT 52 NOVEMBER 1993

EDITORIAL DEPARTMENT

EDITOR Marcus Dyson
DEPUTY EDITOR Julie Tolley
CONSULTANT EDITOR Nick Veitch
PRODUCTION EDITOR Richard Jones
GAMES EDITOR Rob Mead
STAFF WRITER Richard Baguley
STAFF WRITER Stephen Bradley

ART DEPARTMENT

ART EDITOR Sue White
DESIGN Jess Bennett

ADVERTISING DEPARTMENT

GROUP AD MANAGER Jonathan Bint
ADVERTISING MANAGER Jackie Garford
SALES EXEC Anne Green

PRODUCTION

GROUP PROD MANAGER Judith Middleton
ADVERTISING PRODUCTION
Charlotte Brock, Craig Broadbridge
PROD CONTROLLER Claire Thomas
PROD CONTROL ASSNT
Ginette McKeown
ADVERTISING DESIGN
Laura MacGregor, Lisa Withey
PAPER CONTROLLER Fiona Deane

EDITORIAL CONTRIBUTORS

Sarah Tanser, Maff Evans, Jason Holborn, Damien Noonan, Phil South, Steve Faragher, Tim Smith, Brian Larkman, Simon Armstrong, Christaleen Loren, Ron Thornton, Jolyon Ralph, Chris Lloyd, Paul Tyrrell, Steven Jenkins, Frank Bartucca.

PHOTOGRAPHY

Pete Canning

PUBLISHING

PROMOTIONS ASSISTANT Tamara Ward
CIRCULATION MANAGER Jon Bickley
CIRCULATION ASSISTANT Kate Elston
GROUP PUBLISHER Greg Ingham

ADMIN ASSNT Suzannah Angelo-Sparling
COLOUR SCANNING & IMAGESETTING
Jon Moore, Simon Windsor,
Chris Stocker, and Mark Gover
COLOUR ORIGINATORS Phoenix Repro
PRINTED IN THE UK BY St Ives PLC
NEWSTRADE DISTRIBUTION, UK
Future Publishing, 0225 442244

NEWSTRADE DISTRIBUTION,
OVERSEAS MMC Ltd 0483 211222

AMIGA FORMAT

30 Monmouth Street, Bath, Avon, BA1 2BW
Telephone 0225 442244
Facsimile 0225 318740
EMAIL ADDRESS
2-250/107.95@FIDONET.ORG
AMFORMAT@CIX.COMPULINK.CO.UK

SUBSCRIPTIONS, BACK ISSUES and MAIL ORDER

Future Publishing, Somerton, Somerset, TA11 6TB
Telephone 0458 74011
Facsimile 0458 74378

Member of the Audit Bureau of Circulations.



Registered Circulation

144,330

July - December 1992

Home of Britain's
finest magazines.

AMIGA FORMAT

Amiga Format Specials •
Amiga Power • Amiga Shopper •
Caravan Plus • Good Woodworking
• Needlecraft • Classic CD • Edge •
MBUK • Sega Zone • Game Zone
and quite a few others too...
But not Snowboarding UK...



No part of this publication may be transmitted
or reproduced in any form without the
permission of the publishers.

Your guarantee of value

This mag comes from Future Publishing, a company founded just eight years ago but now selling more computer magazines than any other in Britain. We offer:

Better advice. Our titles are packed with tips, suggestions and explanatory features, written by the very best in the business.

Stronger reviews. We have a cast-iron policy of editorial independence and our reviews give clear buying recommendations.

Clearer design. You need solid information fast. So our crayon-wielders highlight key elements by using charts, diagrams, summary boxes, and so on...

Greater relevance. At Future, Editors operate under two golden rules:

- Understand your readers' needs
- Then satisfy them.

More reader interaction. We draw on readers' contributions, resulting in the liveliest letters pages and the best reader tips. Buying one of our magazines is like joining a nationwide user group.

Better value for money.

More pages, better quality - magazines you can trust.

NEXT MONTH

GET REAL!



Real 3D is widely respected as the finest ray tracing program for the Amiga. Next month we have the Junior version of this fine program for your delight.

IF YOU READ our feature on 3D modelling in Issue 49, you are probably dying to give it a go. The problem with 3D programs is that the good ones are very expensive. Although anyone who has used one will tell you that they are worth every penny, it's difficult to appreciate the fact if you have never used one.

So next month we'll be giving you a special working version of Activa International's superb 3D package, *Real 3D 2*.

Real 3D 2 Junior is the perfect introduction to 3D ray-tracing. And we'll be running a full series of tutorials to help you get the best from this superb package.

The full package scored a massive 96 per cent in Issue 46 of *Amiga Format*. And since its release it has come to be regarded as the best 3D package there is.

If you want to try your hand at 3D, you have to get your hands on next month's *Amiga Format*.

ISSUE 53 DECEMBER

WAITING FOR YOU AT YOUR
NEWSAGENT FROM OCTOBER 28TH

NEW

AMIGA ACTION REPLAY MK III

STILL ONLY £59.99

AMIGA A500/500+ FOR 1500/2000 VERSION £69.99

THE WORLDS MOST POWERFUL FREEZER-UTILITY CARTRIDGE JUST LOOK AT THE UNMATCHED RANGE OF FEATURES

SAVE THE ENTIRE PROGRAM IN MEMORY TO DISK

Special compacting techniques enable up to 3 programs to fit on one disk. Now saves directly to disk as Amiga Dos - reloads independently of the cartridge - even transfer to hard drive! Works with up to 2 Megs of Ram - even 1 Meg Chip Mem (Fatter Agnus).

NEW SUPER POWERFUL TRAINER MODE

now with DEEP trainer. Even better than before - allows you to generate more or even infinite lives, fuel, ammo. Perfect as a Trainer Mode to get you past that "impossible" level. Easy to use.

IMPROVED SPRITE EDITOR

The full Sprite Editor allows you to view/modify the whole sprite set including any "attached" sprites. PLUS A RANGE OF IMPROVED FEATURES.

VIRUS DETECTION

Comprehensive virus detection and removal features to protect your software investment. Works with all presently known viruses.

NEW BURST NIEBLER

Now this super disk copier program is built into Action Replay Mk III. Just imagine a superfast, efficient disk copier program at the press of a key - no more waiting.

SAVE PICTURES AND MUSIC TO DISK

Pictures and sound samples can be saved to disk. Files are saved directly in IFF format suitable for use with all the major graphic and music packages. Samples are displayed as screen waveform.

NEW PAL or NTSC MODES SELECTABLE

Useful for removing ugly borders when using NTSC software. (Works only with newer Agnus chips).

NEW SLOW MOTION MODE

Now you can slow down the action to your own pace. Easily adjustable from full speed to 20% speed. Ideal to help you through the tricky parts!

MANY MORE INSTANT CLI COMMANDS

like Rename, Relabel, Copy, etc.

NEW RESTART THE PROGRAM

Simply press a key and the program will continue where you left off.

FULL STATUS REPORTING

At the press of a key now you can view the Machine Status, including Fast Ram, Chip Ram, RamDisk, Drive Status, etc.

POWERFUL PICTURE EDITOR

Now you can manipulate and search for screens throughout memory. Over 50 commands to edit the picture plus unique on screen status "overlay" shows all the information you could ever need to work on screens. No other product comes close to offering such dynamic screen handling of frozen programs!!

NEW JOYSTICK HANDLER

allows the user to select Joystick instead of Keypresses - very useful for many keyboard programs.

MUSIC SOUND TRACKER

With Sound Tracker you can find the complete music in programs, demos, etc. and save them to disk. Saves in format suitable for most track player programs. Works with loads of programs!!

AUTOFIRE MANAGER

From the Action Replay III preference screen you can now set up autofire from 0 to 100%. Just imagine continuous fire power! Joystick 1 and 2 are set separately for that extra advantage!

NEW IMPROVED RAM EXPANSION SUPPORT

Now many more external Ram Expansions will work with all Action Replay III commands.

DISKCODER

With the new "Diskcoder" option you can now 'tag' your disks with a unique code that will prevent the disk from being loaded by anyone else. "Tagged" disks will only reload when you enter the code. Very useful for security.

NEW SET MAP

allows you to Load/Save/Edit a Keymap.

PREFERENCES

Action Replay III now has screen colour preferences with menu setup. Customise your screens to suit your taste. Very simple to use.

DISK MONITOR

Invaluable disk monitor - displays disk information in easy to understand format. Full modify/save options.

IMPROVED PRINTER SUPPORT

including compressed/small character command.

NEW DOS COMMANDS

Now you have a selection of DOS commands available at all times - DIR, FORMAT, COPY, DEVICE, etc.

NEW FILE REQUESTER

if you enter a command without a filename, then a file requestor is displayed.

DISK COPY

Disk Copy at the press of a button - faster than Dos Copy. No need to load workbench - available at all times.

PLUS IMPROVED DEBUGGER COMMANDS

including Mem Watch Points and Trace.

NEW BOOT SELECTOR

Either DFO or DF1 can be selected as the boot drive when working with Amiga Dos disks. Very useful to be able to boot from your external drive.

PLUS A MACHINE CODE FREEZER MONITOR WITH EVEN MORE POWER!!

EVEN MORE FEATURES INCLUDING 80 COLUMN DISPLAY AND 2 WAY SCROLLING:-

- Full M68000 Assembler/Disassembler
- Full screen editor
- Load/Save block
- Write String to memory
- Jump to specific address
- Show Ram as text
- Show frozen picture
- Play resident sample
- Show and edit all CPU registers and flag
- Calculator
- Help command
- Full search feature
- Unique Custom Chip Editor allows you to see and modify all chip registers - even write only registers
- Notepad
- Disk handling - show actual track, Disk Sync. pattern etc.
- Dynamic Breakpoint handling
- Show memory as HEX, ASCII, Assembler, Decimal
- Copper Assemble/Disassemble - now with suffix names

REMEMBER AT ALL TIMES YOU ARE INTERROGATING THE PROGRAM IN IT'S "FROZEN" STATE WITH ALL MEMORY AND REGISTERS INTACT - INVALUABLE FOR THE DE-BUGGER OR JUST THE INQUISITIVE!

WARNING 1988 COPYRIGHT ACT WARNING
 Datel Electronics Ltd., neither condones nor authorises the use of its products for the reproduction of copyright material.
 The backup facilities of this product are designed to reproduce only software such as Public Domain material, the users own programs or software where permission to make backups has been clearly given.
 It is illegal to make copies, even for your own use, of copyright material, without the express permission of the copyright owner, or the licensee thereof.



HOW TO GET YOUR ORDER FAST!

ALL CHEQUES/POSTAL ORDERS MADE PAYABLE TO.....

DATEL ELECTRONICS

GOVAN ROAD, FENTON INDUSTRIAL ESTATE, FENTON,
STOKE-ON-TRENT, ST4 2RS, ENGLAND. FAX 0782 744292
TECHNICAL/CUSTOMER SERVICE 0782 744324

OR CALL AT OUR LONDON SHOP 222, TOTTENHAM COURT RD, LONDON, W1. TEL:071 580 6460

HIGH RESOLUTION HANDY SCANNER

NOW ONLY £89.99

FREE PHOTON PAINT

- IFF Buffer Save 1600x1024 pixels, dual buffer, scan matching & view Buffer.
- Unlimited edit/capture facilities & keyboard control not offered by other scanners at this special price.
- Full keyboard control of most functions.
- An easy to handle Scanner featuring 105 mm scanning width & 400 dpi resolution enables you to scan graphics/text into your Amiga 500/500+/600/1200/1500/2000.
- Includes hard disk transfer to run under Workbench.
- Adjustable switches for brightness/contrast levels.
- Full sizing menu of scan area.
- Geniscan gives you the ability to scan images, text or graphics & even offers 200 Dpi Dual Scan Mode.
- Screen grid overlay & configure menu to save parameters.
- Icon menu to select functions.
- X,Y position readout & metric sizes.
- Save images in suitable format for most leading packages including PHOTON PAINT, DELUXE PAINT, etc.
- View window and position control panel.
- Powerful partner for DTP that allows for cut & paste editing of images etc.



**A Top Quality 400 DPI
Handy Scanner
for the Amiga
at a truly
Unbeatable
Price!!**



GENIUS DIGITIZING TABLET

NOW ONLY £129.99

ADD A PROFESSIONAL TOUCH TO YOUR DRAWING WORK

- With the Amiga Genitizer Graphic Tablet you can streamline the operation of most graphic or CAD programs.
- The Genitizer Graphic Tablet utilises latest technology to offer up to 1000 dpi resolution at the tip of a stylus.
- Complete 9"x6" digitizing area plus super accurate stylus combine to enable fast, accurate and easy control.
- Works by "mouse emulation" so the Genitizer will work with most packages where mouse input is the usual method-Deluxe Paint, Photon Paint, CAD Packages, etc.

- Supplied with template for Deluxe Paint.
- Full easy to follow instructions.
- This is the input method used on professional systems -now you can add a new dimension to graphics/cad.
- Fast input of drawing by "tracing" is made easy - plus "absolute reference" means you can move around the screen many times faster than by a mouse.
- The Genitizer fits in the serial port of your Amiga 500/500+/600/1200/1500/2000 and "co-exists" with mouse.
- Unlike a mouse, the tablet gives absolute co-ordinates so that tracking and menu selections are possible from the tablet face.
- A pressure sensitive switch built into the stylus tip activates the Tablet overriding the normal mouse input. When you are not using the Tablet, you have normal mouse control.
- Complete system - Graphics Digitizer Tablet, Stylus, Deluxe Paint Template, Power Adaptor, Test Software, Interface Unit, plus Driver Program - no more to buy!



GENIUS PUCK

AS AN ALTERNATIVE TO THE STYLUS INPUT THE GENIUS TABLET ALSO HAS AN OPTIONAL FOUR BUTTON PUCK. IDEAL FOR TRACING ETC.

ONLY £29.99

ACCESSORIES

- MIDI MASTER MIDI INTERFACE £19.99**
Best selling Midi Interface for the Amiga. Midi IN, Midi THRU & Midi OUT x3. Complete with 2 FREE Midi Cables.
- MIDI CABLES £7.99 (per pair)**
1.8 metre long genuine Midi Cables.
- LOGIC 3 MOUSE £14.99**
Top quality, super smooth replacement mouse. High resolution.
- VIRUS PROTECTOR £7.99**
Fits in last drive of your system to protect against boot block viruses.
- ROM SHARER £24.99**
Switch between versions of Kickstart to improve software compatibility. Kickstart 1.3 or Kickstart 2.0 at the flick of a switch for Amiga 500+ owners! No more to buy.

ACCESSORIES



**24 HOUR MAIL
ORDER HOTLINE**

0782 744707

ORDERS NORMALLY
DISPATCHED WITHIN 48 Hrs.





**WHEN THE STREET JUST AIN'T
TOUGH ENOUGH...
GO PLAY IN THE PARK**

IF IT'S NOT JURASSIC PARK IT'S EXTINCT

**PC COMPATIBLES
CBM AMIGA
GAME BOY**



**SUPER NINTENDO
ENTERTAINMENT SYSTEM**

**Nintendo
ENTERTAINMENT
SYSTEM**